



15

MAUÿ

FAITE DE

verre

5

115

L 4916

~~1/5~~
~~1/1~~

3257

1X. Takel

M. K. Bányászati
és Erőszeti Akadémia
Könyvtára

TRAITÉ DE MINÉRALOGIE.

PAR LE C^{EN}. HAÛY

Membre de l'Institut National des Sciences et Arts, et Conservateur
des Collections Minéralogiques de l'École des Mines.

PUBLIÉ PAR LE CONSEIL DES MINES.

TOME CINQUIÈME.

*Caractères Minéralogiques. Distribution méthodique des Minéraux.
Figures Géométriques.*



A PARIS,

CHEZ LOUIS, LIBRAIRE, RUE DE SAVOYE, N^o. 12.

(x) 1801.

M. Y. RÁNYÁSZATI
3250
ÉS ERDÉSZETI AKADEMIA
KÖNYVTÁRA

éim. I. k. 1. g. 1. 8. 1. 1.

2311



K. K. Berg-Academie

ME FŐKÖNYVTÁR
2004
LELT-ELLENŐRZÉS

2004 SEPT 08

SYSTÈME DE CARACTÈRES

MINÉRALOGIQUES

DE M. DE LAUNAY

CARACTÈRES

MINÉRALOGIQUES.



LIBRARY

SYSTÈME DE CARACTÈRES

RELATIFS

AUX MINÉRAUX.

PHYSIQUE GÉNÉRALE.

1. Pesanteur spécifique.

Usage de la balance de Nickolson.

2. Consistance.

1. Dans les solides éprouvés.

2. Dans les liquides.

- 1. Par le frottement de la lime.
- 2. Par le frottement des parties anguleuses d'un corps sur la surface d'un autre. }
- 3. Par la percussion du marteau.
- 4. Par le choc du briquet. }
- 5. Par la flexion ou par la pression.
- 6. Par la force de traction. .
- Facilité de céder à la plus légère pression. . . . }

- 1. Les corps durs résistent. La télésie.
- 2. Les corps tendres cèdent. La chaux carbonatée.
- La télésie raye le quartz.
- 1. Difficiles à briser. L'émeril.
- 2. Fragiles. Le soufre.
- 3. Friables, qui s'égrènent aisément. Certains grès.
- 1. Étincelans. Le quartz.
- 2. Non étincelans. La chaux fluatée.
- 1. Simplement flexibles. Le talc laminaire.
- 2. Élastiques. Le mica.
- 3. Ductiles. L'or, l'argent, etc.
- 4. Mous. { 1. Dans l'état naturel. Le bitume glutineux.
- 2. Après l'imbibition. L'argile.
- Corps doués de ténacité. L'or, l'argent, le fer, etc.
- 1. En mouillant le corps qui les presse. Le pétrole.
- 2. Sans le mouiller. Le mercure.

CORPS, CORPS, CORPS.

I. CARACTÈRES PHYSIQUES.

PHYSIQUE PARTICULIÈRE.

3. Impression sur la langue.	}	1. Saveur.	}	1. Salée. La soude muriatée.			
		2. Happement.		2. Astringente. Le fer sulfaté.			
		Surface ou poussière.		3. Douceâtre. L'alumine sulfatée.			
4. Impression sur le tact.	}	1. Onctueuse au toucher. Le talc.	}	4. Fraîche. La potasse nitratée.			
		2. Douce (sans onctuosité). L'asbeste flexible.		5. Amère. La magnésie sulfatée.			
		3. Aride. Le feld-spath argiliforme (kaolin).		6. Urineuse et piquante. L'ammoniaque muriaté.			
5. Odeur.	}	1. Par la vapeur de l'haleine.	}	Quelques argiles, le quartz-résinite hydrophane.			
		2. Par le frottement.		1. D'ail. L'arsenic.			
		3. Par le feu.		2. Bitumineuse. La houille.			
6. Son.	}	1. Par la percussion.	}	3. Sulfureuse. Le soufre.			
		2. Par la flexion.		L'ardoise, les métaux.			
		1. Leurs espèces.		Cri de l'étain.			
1. Couleurs de la masse.	}	2. Leur distribu-	}	Rouge, jaune, vert, bleu, etc.			
		tion.		1. Uniforme. L'émeraude verte, le quartz-agathe cornaline, etc.			
		3. Leur jeu.		2. Variée. { 1. Par taches. Les marbres secondaires.			
2. Couleur de la rapure.	}	}	}	2. Par bandes. Le quartz-agathe onyx.			
				3. Couleur de la tachure.	}	}	1. Par chatoyement. Le feld-spath nacré.
							}
7. Lumière.	}	}	1. Similaire ou la même que celle de la masse. L'argent antimonié sulfuré.				
			}	}	2. Dissimilaire. Le mica donne une poussière blanchâtre.		
					}	}	1. Similaire. Le fer carburé.
}	}	2. Dissimilaire. Le molybdène sulfuré tache la porcelaine en vert.					
		}	}	1. Brillante. Le quartz-hyalin.			
				}	}	2. Terme. Le quartz-jaspe.	
}	}					3. Onctueuse à l'œil. Le jade poli.	
		}	}			4. Soyeuse. La chaux sulfatée fibreuse.	
				}	}	5. Nacrée. La stilbite.	
}	}					6. Ayant le brillant métallique. L'or natif.	
		}	}			7. N'en ayant que l'apparence. Le mica argentif.	
				}	}	1. Corps limpides; transparents et sans couleur. La télésie, dite saphir blanc.	
}	}					2. Corps transparents avec couleur. Le spinelle.	
		}	}			3. Corps translucides, qui laissent passer trop peu de lumière pour permettre de rien distinguer à travers leur masse. Le quartz, dit agathe orientale.	
				}	}	4. Corps opaques. L'or, l'argent, etc., à l'état natif.	
}	}					1. Simple. La télésie.	
		}	}			2. Double. La chaux carbonatée.	
				}	}	1. A l'aide du feu. La chaux phosphatée.	
}	}					2. A l'aide du frottement. Le quartz gras, la grammatite.	
		}	}			1. Par communication. { Les métaux à l'état métallique.	
				}	}	2. Par frottement. { 1. Vitrée. La plupart des substances terreuses.	
}	}					2. Résineuse. Le soufre, le succin.	
		}	}			3. Par chaleur. { Vitrée d'un côté et résineuse de l'autre. La tourmaline, la mésotype.	
				}	}	1. Vitrée. Le molybdène sulfuré.	
}	}					2. Résineuse. La plupart des minéraux.	
		}	}			3. Nulle. Le fer carburé.	
				9. Magnétisme.	}	}	}
}	}						

II. CARACTÈRES GÉOMÉTRIQUES.

- | | | | |
|--|--|--|---|
| 1. Formes. | <ul style="list-style-type: none"> 1. Déterminables. 2. Indéterminables. 3. Imitatives. | 1. Élémentaires. | <ul style="list-style-type: none"> 1. Noyau ou forme primitive. 2. Molécule intégrante. 3. Molécule soustractive. |
| | | 2. Secondaires. | <ul style="list-style-type: none"> 1. Leurs lois de décroissemens. 2. Mesures de leurs angles. |
| | | <ul style="list-style-type: none"> 1. Arrondissemens des faces et des angles. 2. Stries et aspérités. 3. Corps amorphes. D'une forme tout à fait irrégulière. | |
| 2. Structure. Tissu d'un minéral dépendant de l'agrégation des molécules ou du groupement des parties. | | 1. Corps concrétionnés; coniques, cylindriques, globuleux, etc. | |
| | | 2. Pseudomorphoses; corps qui ont pris la forme d'un autre corps auquel ils se sont substitués. | |
| | | 1. Laminaire; offrant des lames continues. | <ul style="list-style-type: none"> 1. Également nets en tout sens. La chaux carbonatée. 2. Plus nets dans un sens que dans l'autre. La chaux sulfatée. 3. Sensibles seulement par le chatoyement à une vive lumière. Le plomb carbonaté. |
| | | | |
| | | 3. Stratiforme; par couches non séparables. | Certains quartz-agathes. |
| | | 4. Feuilletée; par couches séparables. | Le talc, dit <i>craie de Briançon</i> . |
| | | 5. Fibreuse. | <ul style="list-style-type: none"> 1. A fibres parallèles. La chaux sulfatée, dite <i>soyeuse</i>. 2. Radiée, ou à fibres divergentes. La baryte sulfatée, dite <i>Pierre de Bologne</i>. |
| | | 6. Granulense. | Le grès. |
| 7. Compacte; formée de parties indiscernables à l'œil. | Le quartz-jaspe. | | |
| 3. Cassure. Manière dont les portions d'un minéral se séparent, lorsque la division ne suit point l'ordre de la structure. | | 8. Cellulaire. | Le quartz-agathe molairé. |
| | | 1. Ses directions. | 1. Longitudinale; ayant lieu parallèlement à l'axe des cristaux. La topaze. |
| | | | 2. Transversale; ayant lieu perpendiculairement à l'axe des cristaux. L'amphibole. |
| | | | 3. Indéfinie; ayant lieu dans tous les sens. Le quartz-agathe. |
| | | 2. Ses accidens. | 1. Conchoïde; par concavités et convexités. Le quartz. |
| 2. Lisse. Le pléonaste. | | | |
| 3. Raboteuse. L'argile. | | | |
| 4. Écailleuse. Le quartz-agathe prase. | | | |
| 5. Articulée. Une face convexe emboîtée dans une face concave, par la fracture faite à un cristal prismatique. La tourmaline. | | | |

NATURELS JOINTS

Cristaux joints naturels

III. CARACTÈRES
 CHIMIQUES.

- | | | | | | | |
|--|---|--|---|--|---|---|
| 1. Par le feu. . . | } | 1. Au chalu-
meau. . . | } | 1. Fusibilité. | } | 1. Sans addition. Le grenat, le feld-spath. |
| | | | | 2. Résultat de la fusion. | | 2. Seulement avec addition. La topaze, le zircon. |
| | | | | 3. Réduction des substances métalliques. . . | | 1. Verre. La tourmaline.
2. Email. Le feld-spath.
3. Masse spongieuse. La mésotype. |
| 2. Par les acides
et en particu-
lier par l'acide
nitrique. | } | 2. Sur les
charbons
ardens. . . | } | 3. Réduction des substances métalliques. . . | } | L'argent antimonial, l'argent sulfuré, le plomb
carbonaté, etc. |
| | | | | 1. Volatilité. L'ammoniaque muriaté. | | |
| | | | | 2. Détonnation avec un corps combustible. La potasse nitratée. | | |
| | | | | 3. Décrépitation. La soude muriatée. | | |
| 3. Par les alkalis | } | 4. Bouillonnement. L'alumine sulfatée. | } | 1. Dissolution avec effervescence. La chaux carbonatée. | } | |
| | | | | 2. Dissolution sans effervescence. La chaux phosphatée. | | |
| | | | | 3. Réduction en gelée. Le zinc oxydé. | | |
| | | | | | | 1. La dissolution du cuivre par l'ammoniaque est d'un beau bleu. |
| | | | | | | 2. La vapeur du sulfure ammoniacal noircit le plomb carbonaté. |

DISTRIBUTION MÉTHODIQUE

DES MINÉRAUX,

PAR CLASSES, ORDRES, GENRES ET ESPÈCES.

PREMIÈRE CLASSE.

Substances acidifères composées d'un acide uni à une terre ou à un alcali, et quelquefois à l'un et à l'autre.

PREMIER ORDRE.

Substances acidifères terreuses.

PREMIER GENRE.

CHAUX.

Première espèce.

Chaux carbonatée.

APPENDICE.

Chaux carbonatée unie à différentes substances, de manière à conserver sa structure, ou quelque autre de ses principaux caractères.

1. Chaux carbonatée aluminifère.
2. Chaux carbonatée ferrifère.
3. Chaux carbonatée quartzifère.

4. Chaux carbonatée magnésifère.

5. Chaux carbonatée fétide.

6. Chaux carbonatée bituminifère.

Seconde espèce.

Chaux phosphatée.

Troisième espèce.

Chaux fluatée.

Quatrième espèce.

Chaux sulfatée.

Cinquième espèce.

Chaux nitratée.

Sixième espèce.

Chaux arseniatée.

SECOND GENRE.

BARYTE.

Première espèce.

Baryte sulfatée.

Seconde espèce.

Baryte carbonatée.

T R O I S I È M E G E N R E .

S T R O N T I A N E .

Première espèce.

Strontiane sulfatée.

Seconde espèce.

Strontiane carbonatée.

Q U A T R I È M E G E N R E .

M A G N É S I E .

Première espèce.

Magnésie sulfatée.

Seconde espèce.

Magnésie boratée.

S E C O N D O R D R E .

Substances acidifères alcalines.

P R É M I E R G E N R E .

P O T A S S E .

Espèce unique.

Potasse nitratée.

S E C O N D G E N R E .

S O U D E .

Première espèce.

Soude muriatée.

Seconde espèce.

Soude boratée.

Troisième espèce.

Soude carbonatée.

T R O I S I È M E G E N R E .

A M M O N I A Q U E .

Espèce unique.

Ammoniaque muriaté.

T R O I S I È M E O R D R E .

Substances acidifères alkalino-terreuses.

G E N R E U N I Q U E .

A L U M I N E .

Première espèce.

Alumine sulfatée alkaline.

Seconde espèce.

Alumine fluatée alkaline.

S E C O N D E C L A S S E .

*Substances terreuses , dans la composition
desquelles il n'entre que des terres , unies
quelquefois avec un alkali.*

Première espèce.

Q U A R T Z .

Quartz-hyalin.

Quartz-agathe.

Quartz-résinite.

Quartz-jaspe.

Quartz-pseudomorphique.

Seconde espèce.

Zircon.

Troisième espèce.

Télésie.

	Quatrième espèce.		Dix-neuvième espèce.
Cymophane.			Actinote.
	Cinquième espèce.		Vingtième espèce.
Spinelle.			Pyroxène.
	Sixième espèce.		Vingt et unième espèce.
Topaze.			Staurotide.
	Septième espèce.		Vingt-deuxième espèce.
Emeraude.			Epidote.
	Huitième espèce.		Vingt-troisième espèce.
Euclase.			Sphène.
	Neuvième espèce.		Vingt-quatrième espèce.
Grenat.			Wernerite.
	Dixième espèce.		Vingt-cinquième espèce.
Amphigène.			Diallage.
	Onzième espèce.		Vingt-sixième espèce.
Idocrase.			Anatase.
	Douzième espèce.		Vingt-septième espèce.
Meionite.			Diopase.
	Treizième espèce.		Vingt-huitième espèce.
Feld-spath.			Gadolinite.
	Quatorzième espèce.		Vingt-neuvième espèce.
Corindon.			Lazulite.
	Quinzième espèce.		Trentième espèce.
Pléonaste.			Mésotype.
	Seizième espèce.		Trente et unième espèce.
Axinite.			Stilbite.
	Dix-septième espèce.		Trente-deuxième espèce.
Tourmaline.			Prehnite.
	Dix-huitième espèce.		Trente-troisième espèce.
Amphibole.			Chabasic.

Trente-quatrième espèce.
Analcime.

Trente-cinquième espèce.
Népheline.

Trente-sixième espèce.
Harmotome.

Trente-septième espèce.
Péridot.

Trente-huitième espèce.
Mica.

Trente-neuvième espèce.
Disthène.

Quarantième espèce.
Grammatite.

Quarante et unième espèce.
Pyenite.

Quarante-deuxième espèce.
Dipyre.

Quarante-troisième espèce.
Asbeste.

Quarante-quatrième espèce.
Talc.

Quarante-cinquième espèce.
Macle.

TROISIÈME CLASSE.

Substances combustibles non métalliques.

PREMIER ORDRE.

SIMPLES.

Première espèce.
Soufre.

Seconde espèce.
Diamant.

Troisième espèce.
Anthracite.

SECON D O R D R E,

COMPOSÉES.

Première espèce.
Bitume.

Seconde espèce.
Houille.

Troisième espèce.
Jayet.

Quatrième espèce.
Succin.

Cinquième espèce.
Mellite.

QUATRIÈME CLASSE.

Substances métalliques.

PREMIER ORDRE.

Non oxydables immédiatement, si ce n'est à un feu très-violent, et réductibles immédiatement.

PREMIER GENRE.

PLATINE.

Espèce unique.
Platine natif (ferrifère).

SECON D GENRE.

O R.

Espèce unique.
Or natif.

T R O I S I È M E G E N R E .

A R G E N T .

Première espèce.

Argent natif.

Seconde espèce.

Argent antimonial.

Troisième espèce.

Argent sulfuré.

Quatrième espèce.

Argent antimonié sulfuré.

Cinquième espèce.

Argent muriaté.

S E C O N D O R D R E .

Oxydables et réductibles immédiatement.

G E N R E U N I Q U E .

M E R C U R E .

Première espèce.

Mercure natif.

Seconde espèce.

Mercure argental.

Troisième espèce.

Mercure sulfuré.

Quatrième espèce.

Mercure muriaté.

T R O I S I È M E O R D R E .

Oxydables, mais non réductibles immédiatement.

S E N S I B L E M E N T D U C T I L E S .

P R E M I E R G E N R E .

P L O M B .

Première espèce.

Plomb natif (volcanique).

Seconde espèce.

Plomb sulfuré.

Troisième espèce.

Plomb arsenié.

Quatrième espèce.

Plomb chromaté.

Cinquième espèce.

Plomb carbonaté.

Sixième espèce.

Plomb phosphaté.

Septième espèce.

Plomb molybdaté.

Huitième espèce.

Plomb sulfaté.

S E C O N D G E N R E .

N I C K E L .

Première espèce.

Nickel arsenical.

Seconde espèce.

Nickel oxydé.

T R O I S I È M E G E N R E .

C U I V R E .

- Première espèce.
 Cuivre natif.
 Seconde espèce.
 Cuivre pyriteux.
 Troisième espèce.
 Cuivre gris.
 Quatrième espèce.
 Cuivre sulfuré.
 Cinquième espèce.
 Cuivre oxydé rouge.
 Sixième espèce.
 Cuivre muriaté.
 Septième espèce.
 Cuivre carbonaté bleu.
 Huitième espèce.
 Cuivre carbonaté vert.
 Neuvième espèce.
 Cuivre arseniaté.
 Dixième espèce.
 Cuivre sulfaté.

Q U A T R I È M E G E N R E .

F E R .

- Première espèce.
 Fer oxydulé.
 Seconde espèce.
 Fer oligiste.

Troisième espèce.

Fer arsenical.

Quatrième espèce.

Fer sulfuré.

Cinquième espèce.

Fer carburé.

Sixième espèce.

Fer oxydé.

Septième espèce.

Fer azuré.

Huitième espèce.

Fer sulfaté.

Neuvième espèce.

Fer chromaté.

C I N Q U I È M E G E N R E

E T A I N .

- Première espèce.
 Etain oxydé.
 Seconde espèce.
 Etain sulfuré.

S I X I È M E G E N R E .

Z I N C .

- Première espèce.
 Zinc oxydé.
 Seconde espèce.
 Zinc sulfuré.
 Troisième espèce.
 Zinc sulfaté.

NON DUCTILES.

SEPTIÈME GENRE.

B I S M U T H.

Première espèce.

Bismuth natif.

Seconde espèce.

Bismuth sulfuré.

Troisième espèce.

Bismuth oxydé.

HUITIÈME GENRE.

C O B A L T.

Première espèce.

Cobalt arsenical.

Seconde espèce.

Cobalt gris.

Troisième espèce.

Cobalt oxydé noir.

Quatrième espèce.

Cobalt arseniaté.

NEUVIÈME GENRE.

A R S E N I C.

Première espèce.

Arsenic natif.

Seconde espèce.

Arsenic oxydé.

Troisième espèce.

Arsenic sulfuré.

1. Arsenic sulfuré rouge.

2. Arsenic sulfuré jaune.

DIXIÈME GENRE.

M A N G A N È S E.

Espèce unique.

Manganèse oxydé.

ONZIÈME GENRE.

A N T I M O I N E.

Première espèce.

Antimoine natif.

Seconde espèce.

Antimoine sulfuré.

Troisième espèce.

Antimoine oxydé.

Quatrième espèce.

Antimoine hydrosulfuré.

DOUZIÈME GENRE.

U R A N E.

Première espèce.

Urane oxydulé.

Seconde espèce.

Urane oxydé.

TREIZIÈME GENRE.

M O L Y B D È N E.

Espèce unique.

Molybdène sulfuré.

QUATORZIÈME GENRE.

T I T A N E.

Première espèce.

Titane oxydé.

Seconde espèce.

Titane siliceo-calcaire.

QUINZIÈME GENRE.

SCHÉELIN.

Première espèce.

Schéelin ferruginé.

Seconde espèce.

Schéelin calcaire.

SEIZIÈME GENRE.

TELLURE.

Espèce unique.

Tellure natif (uni à différens métaux).

DIX-SEPTIÈME GENRE.

CHROME.

PREMIER APPENDICE.

Substances dont la nature n'est pas encore assez connue, pour permettre de leur assigner des places dans la méthode.

1. Amianthoïde.
2. Aplome.
3. Arragonite.
4. Chaux sulfatée anhydre.
5. Chaux sulfatée quartzifère.
6. Coccolithe.
7. Diaspore.
8. Ecume de terre.
9. Emeraude de France ?
10. Feld-spath apyre ?

11. Jade.

12. Koupholithe.

13. Lépidolithe.

14. Madréporite.

15. Malacolithe.

16. Micarelle.

17. Petrosilex.

18. Scapolite.

19. Spath chatoyant.

20. Spath schisteux.

21. Spinthère.

22. Tourmaline apyre ?

23. Triphane.

24. Zéolithe efflorescente.

25. Zéolithe radiée jaunâtre.

26. Zéolithe rouge d'Ædelfors.

SECONDE APPENDICE.

Agrégats de différentes substances minérales.

PREMIER ORDRE.

Agrégats que l'on regarde comme étant de première formation, et qui portent plus particulièrement le nom de roches.

1. Roche feld-spathique.
2. Roche quartzeuse.
3. Roche amphibolique.
4. Roche micacée.
5. Roche talqueuse.
6. Roche calcaire.
7. Roche jadienne.
8. Roche petrosiliceuse.
9. Roche cornéenne.

10. Roche

10. Roche serpentineuse.

11. Roche argileuse.

S E C O N D O R D R E.

Agrégats qui sont généralement regardés comme étant de seconde ou de troisième formation, et qui paroissent devoir leur naissance à des sédimens, et leur dureté au dessèchement.

I. A R G I L E.

1. Argile glaise.

2. Argile smectique.

3. Argile lithomarge.

4. Argile ocreuse.

5. Argile schisteuse.

II. A R G I L E C A L C A R I F È R E O U M A R N E.

III. C A L C A I R E P O L I S S A B L E A R G I L O - F E R R I F È R E O U M A R B R E S E C O N D A I R E.

IV. C H A U X S U L F A T É E C A L C A R I F È R E, v u l g a i r e m e n t *Pierre à plâtre.*

T R O I S I È M E O R D R E.

Agrégats composés de fragmens ou de débris, agglutinés postérieurement à la formation des substances auxquelles ils ont appartenu.

I. Q U A R T Z - A G A T H E B R È C H E.

II. C A L C A I R E B R È C H E.

III. Q U A R T Z A R É N A C É A G G L U T I N É O U G R È S.

IV. Q U A R T Z A L U M I N I F È R E T R I P O L É E N ; *Tri-poli.*

V. G R A N I T E R E C O M P O S É, v u l g a i r e m e n t *grès des houillères.*

T R O I S I È M E A P P E N D I C E.

Produits des Volcans.

P R E M I È R E C L A S S E.

L A V E S.

Matières qui ont éprouvé la fluidité ignée.

P R E M I E R O R D R E.

Laves lithoïdes, c'est-à-dire, ayant l'apparence d'une pierre.

P R E M I E R G E N R E.

L A V E S L I T H O Ï D E S B A S A L T I Q U E S.

S E C O N D G E N R E.

L A V E S L I T H O Ï D E S P E T R O S I L I C E U S E S.

T R O I S I È M E G E N R E.

L A V E S L I T H O Ï D E S F E L D - S P A T H I Q U E S.

Q U A T R I È M E G E N R E.

L A V E S L I T H O Ï D E S A M P H I G É N I Q U E S.

S E C O N D O R D R E.

Laves vitreuses ; ayant plus ou moins l'apparence d'une matière vitrifiée.

1. Lave vitreuse obsidienne.

2. Lave vitreuse émaillée.

3. Lave vitreuse perlée.

4. Lave vitreuse pumicée.

5. Lave vitreuse capillaire.

TROISIÈME ORDRE.

Laves scorifiées ; ayant plus ou moins de rapport , par leur aspect , avec les scories des forges.

SECONDE CLASSE.

THERMANTIDES.

Matières qui n'offrent que des indices de cuisson.

1. Thermantide cimentaire.
2. Thermantide tripoléenne.
3. Thermantide pulvérulente.

TROISIÈME CLASSE.

PRODUITS DE LA SUBLIMATION.

1. Soufre.
2. Ammoniaque muriaté.
3. Arsenic sulfuré.
4. Fer oligiste , etc.

QUATRIÈME CLASSE.

LAVES ALTÉRÉES.

Laves qui ont subi une décomposition plus ou moins avancée , par l'effet des vapeurs acido-sulfureuses , ou des vicissitudes de l'atmosphère.

Lave altérée alunifère. Pierre alumineuse de la Tolfa.

CINQUIÈME CLASSE.

TUFFS VOLCANIQUES.

Produits des éruptions boueuses , empâtemens et agglutinations par la voie humide.

SIXIÈME CLASSE.

Substances qui ont été formées dans l'intérieur des laves , postérieurement à l'époque où celles-ci ont coulé.

1. Mésotype.
2. Analcime.
3. Stilbite.
4. Chabasie.
5. Chaux carbonatée.
6. Fer sulfuré , etc.

SUBSTANCES qui ont été modifiées par la chaleur des feux souterrains non volcaniques.

1. Thermantide (non volcanique) porcellanite.
2. Thermantide (non volcanique) tripoléenne.

F I G U R E S

G · É O M É T R I Q U E S .

Fig. 1.



Fig. 2.

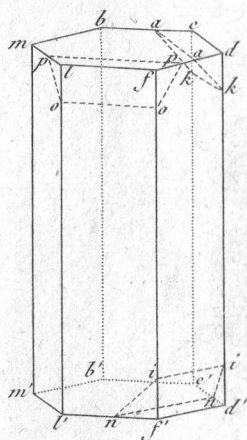


Fig. 3.

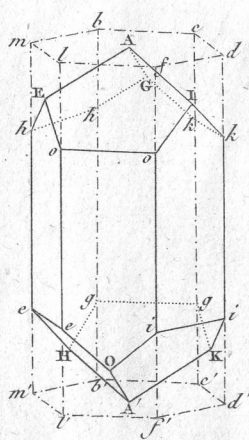


Fig. 4.

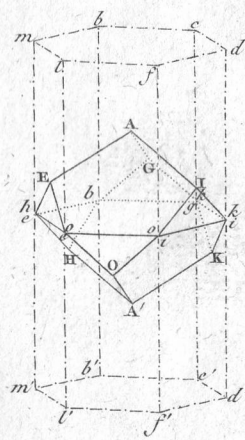


Fig. 5.

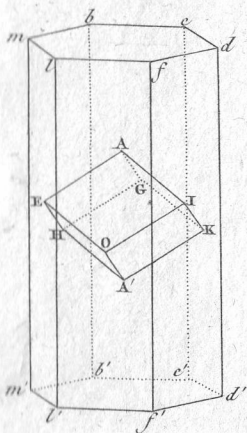


Fig. 6.

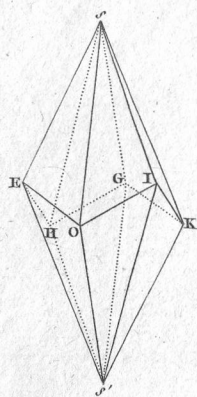


Fig. 7.

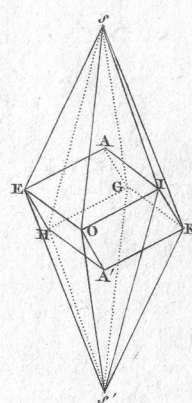
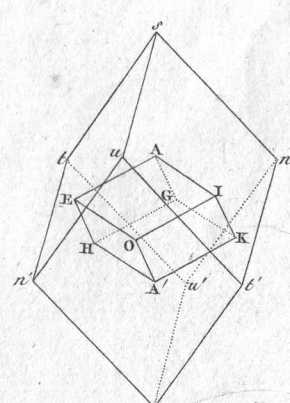


Fig. 8.



M. V. DANYÁSZATI
ÉS ERDÉSZETI MUSEUM
KÖNYVTÁRA
Lévy J. Sculp.

Fig. 9.

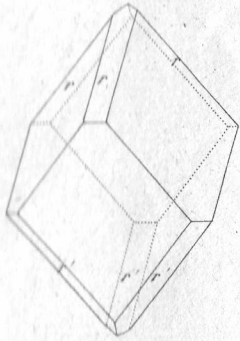


Fig. 10.

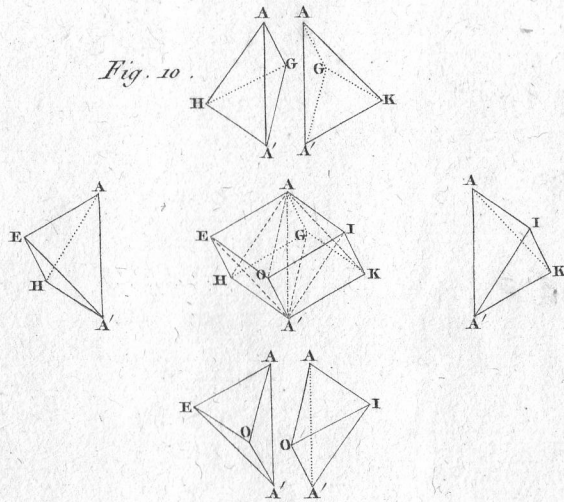


Fig. 11.

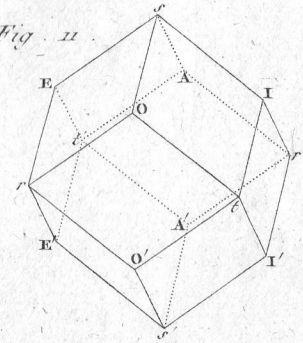


Fig. 12.

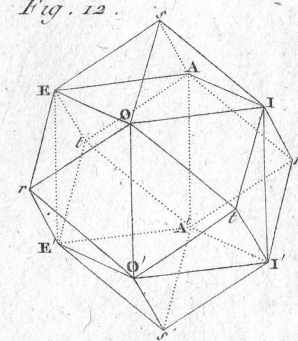


Fig. 13.

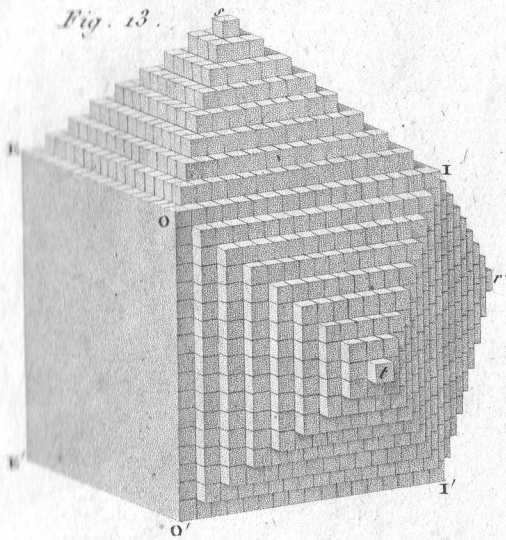


Fig. 14.

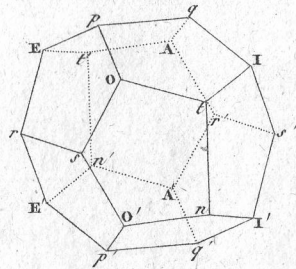


Fig. 15.

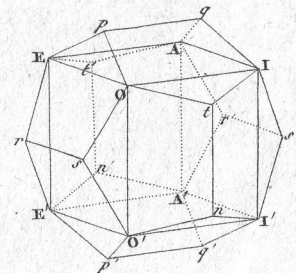
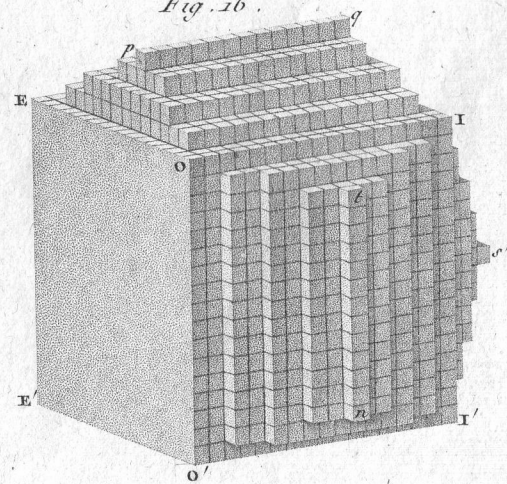


Fig. 16.



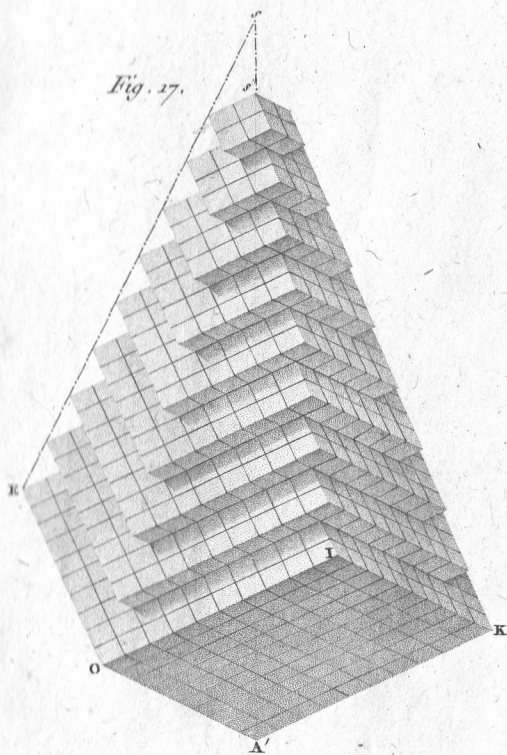


Fig. 17.

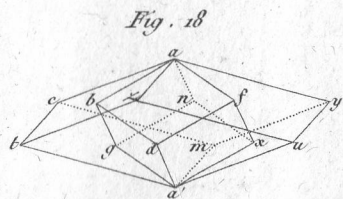


Fig. 18

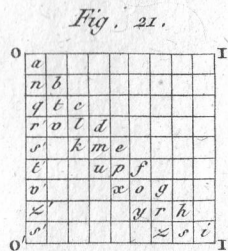


Fig. 21.

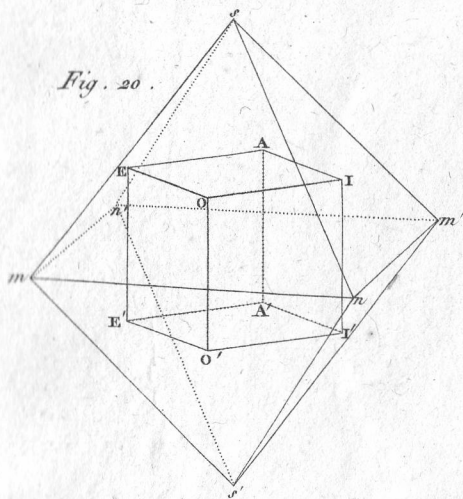


Fig. 20.

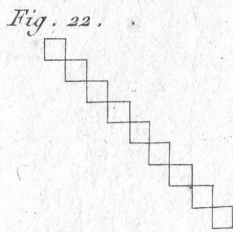
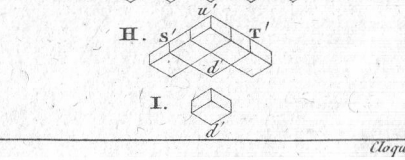
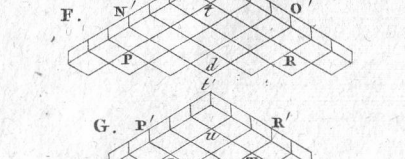
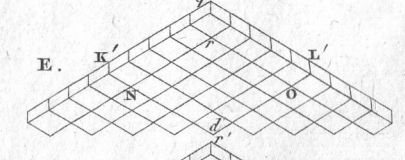
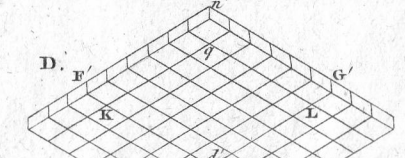
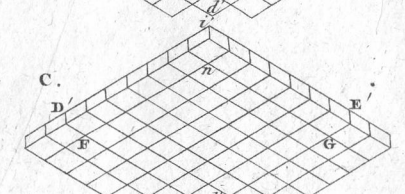
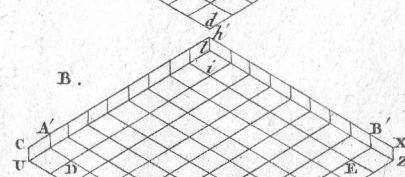
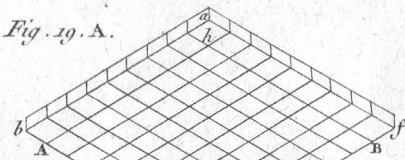


Fig. 22.

Fig. 19. A.



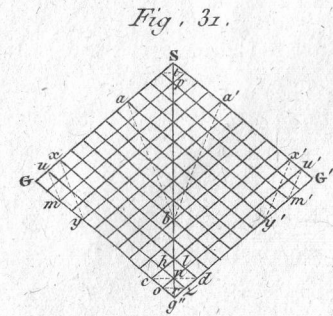
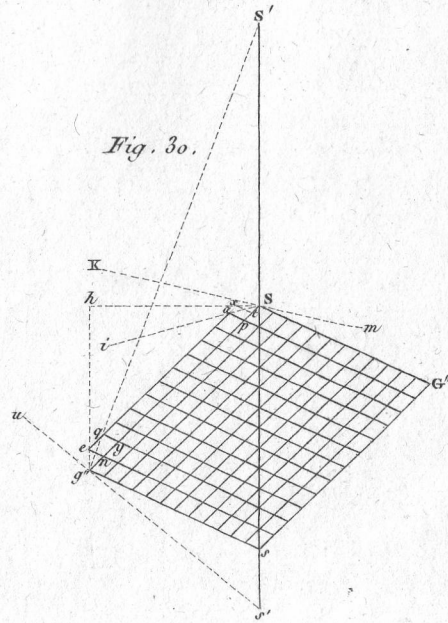
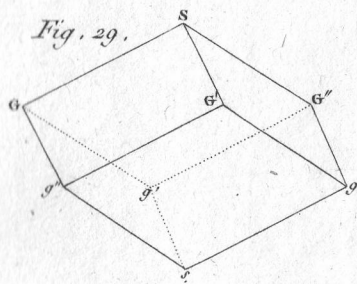
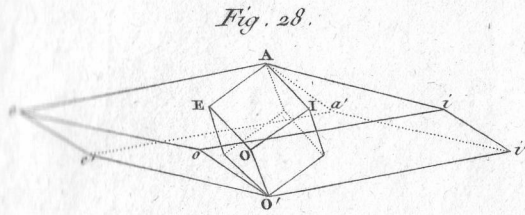
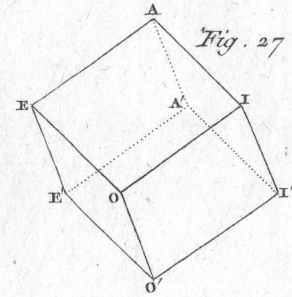
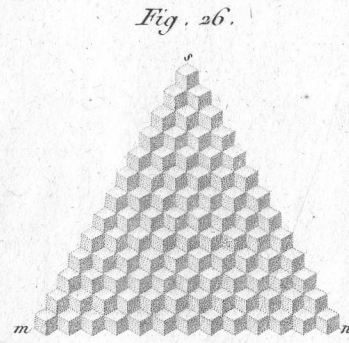
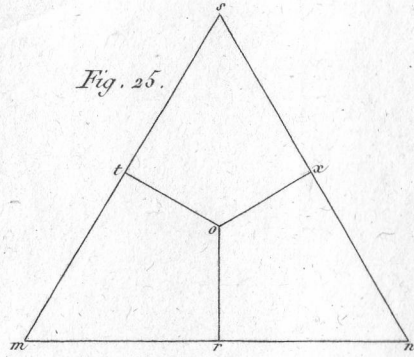
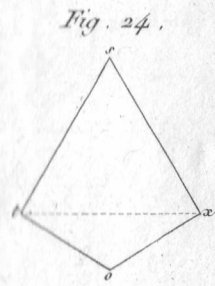
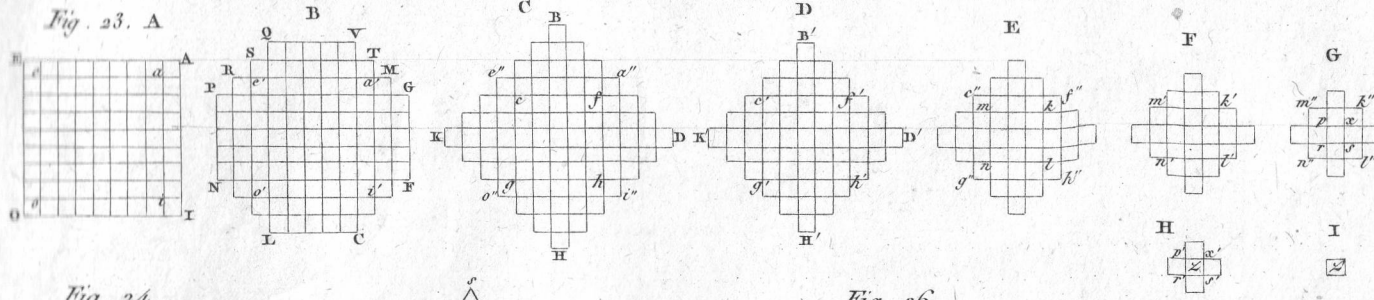


Fig. 32.

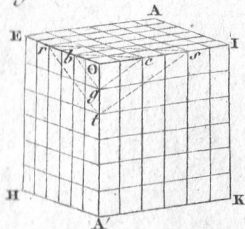


Fig. 33.

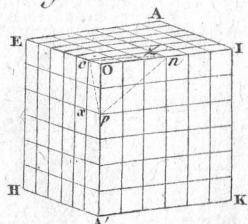


Fig. 34.

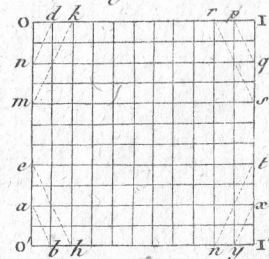


Fig. 35.

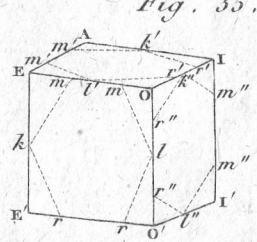


Fig. 36.

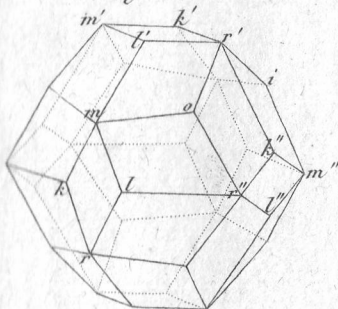


Fig. 38.

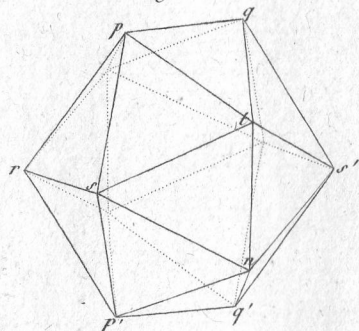


Fig. 40.

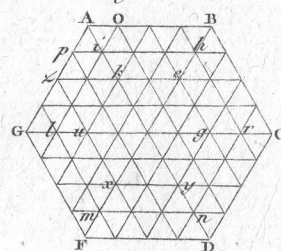


Fig. 42.

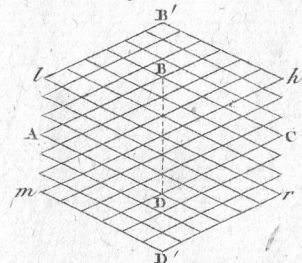


Fig. 37.

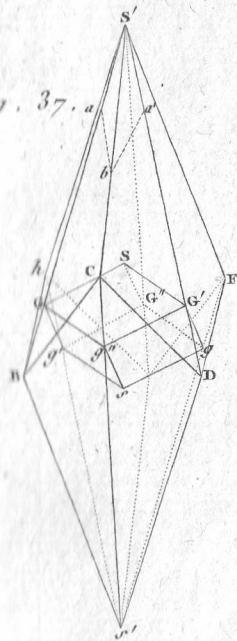


Fig. 39.

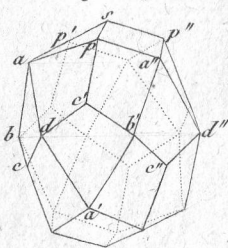


Fig. 41.

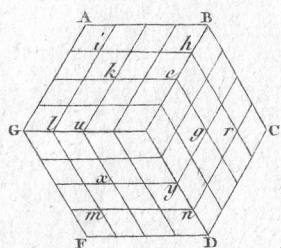


Fig. 43.

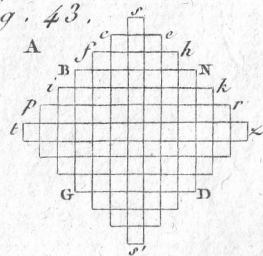


Fig. 39.A

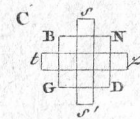
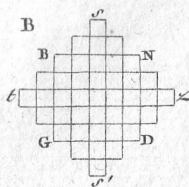
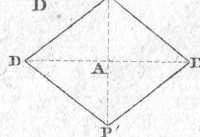
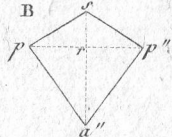
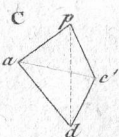
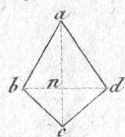


Fig. 44.

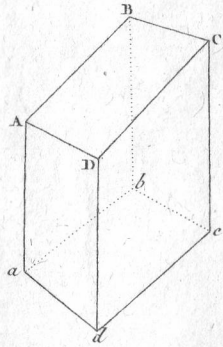


Fig. 45.

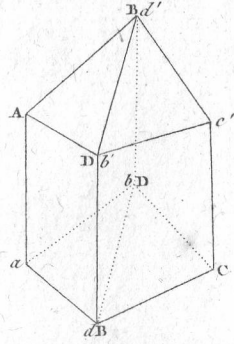


Fig. 46.

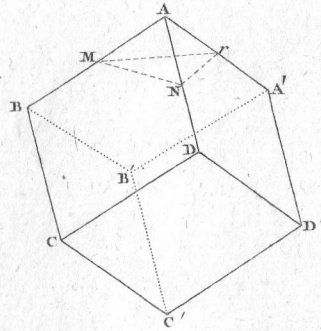


Fig. 47.

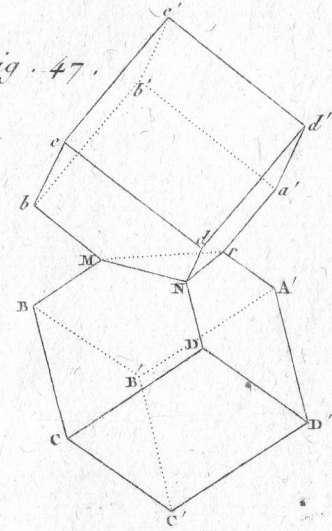


Fig. 48.

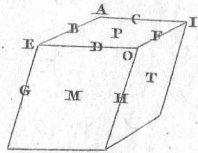


Fig. 49.

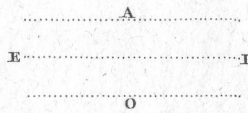


Fig. 50.

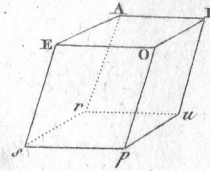


Fig. 51.

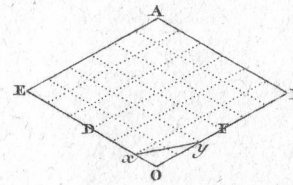


Fig. 52.

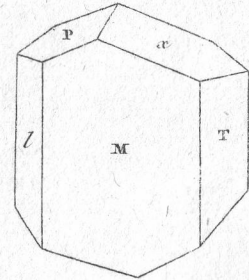


Fig. 53.

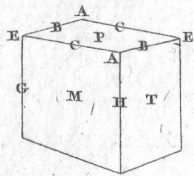


Fig. 54.

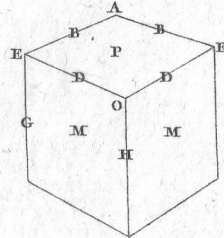


Fig. 55.

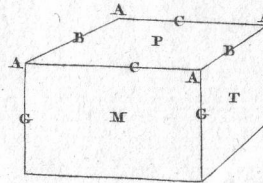


Fig. 56.

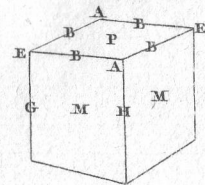


Fig. 57.

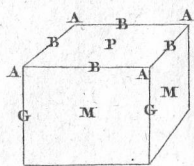


Fig. 58.

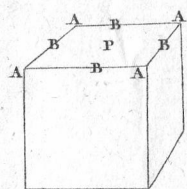


Fig. 59.

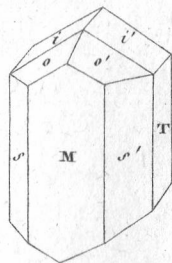


Fig. 60.

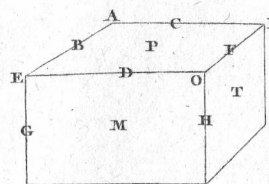


Fig. 61.

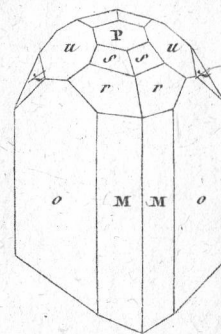


Fig. 62.

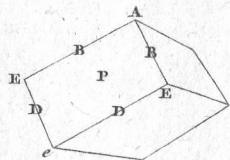


Fig. 63.

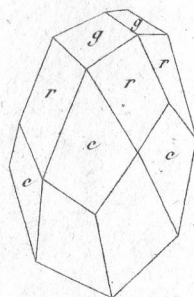


Fig. 64.

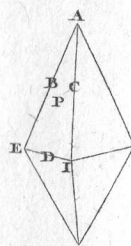


Fig. 65.

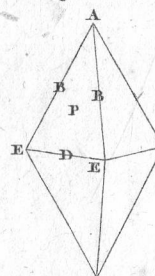


Fig. 66.

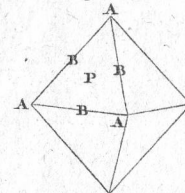


Fig. 67.



Fig. 68.

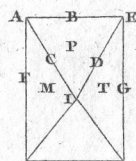


Fig. 69.

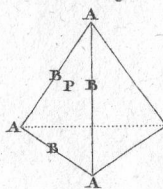


Fig. 70.

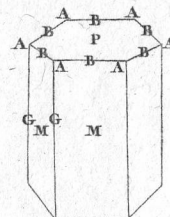
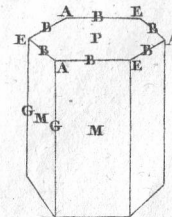
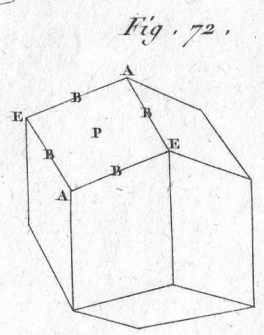
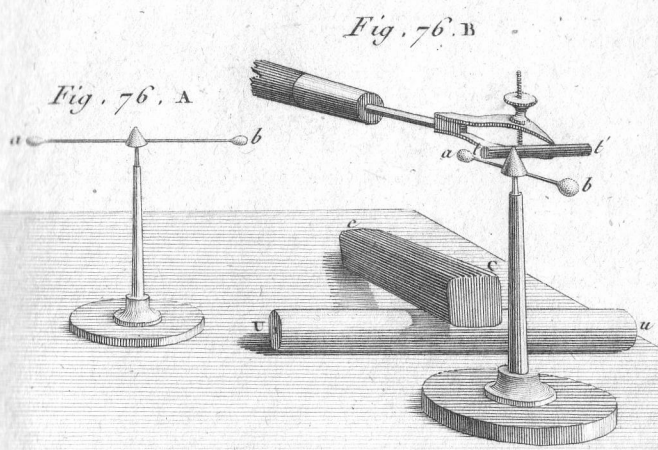
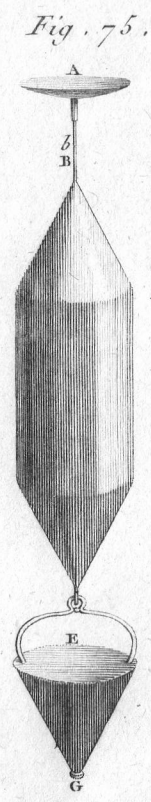
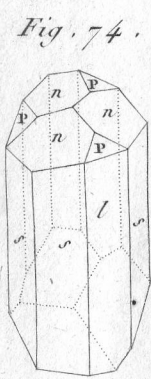
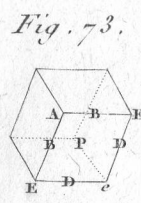
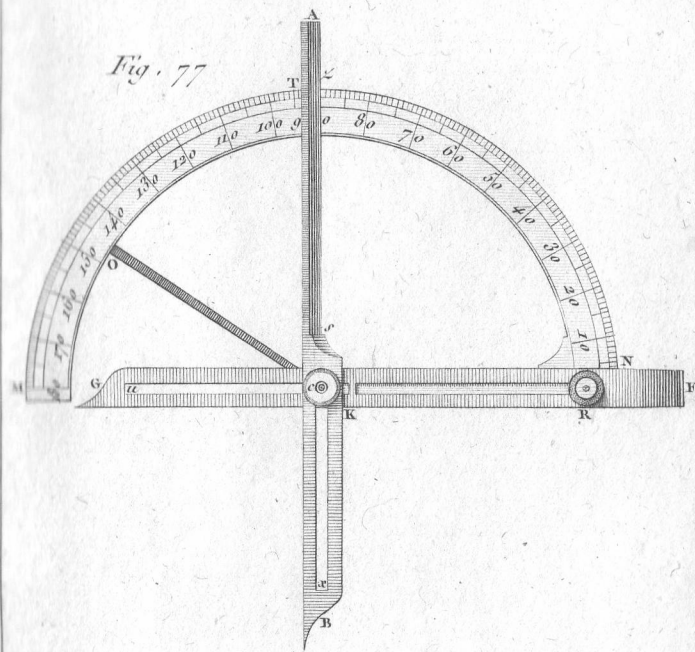


Fig. 71.





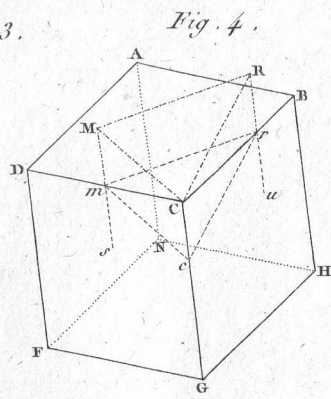
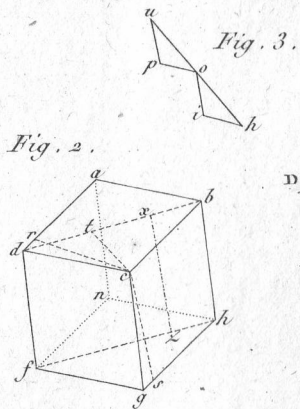
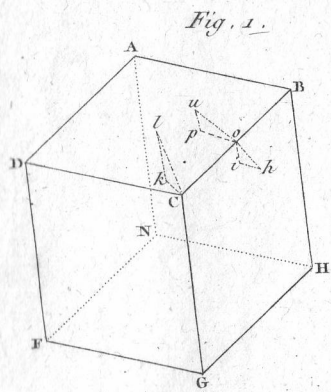


Fig. 4.

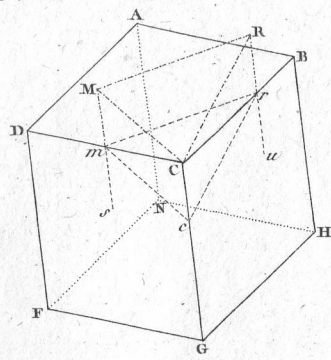


Fig. 5.

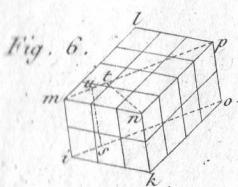
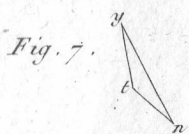
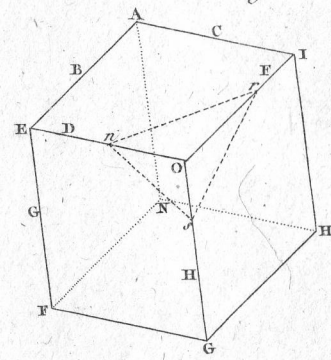


Fig. 8.

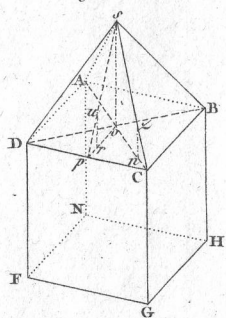


Fig. 9.

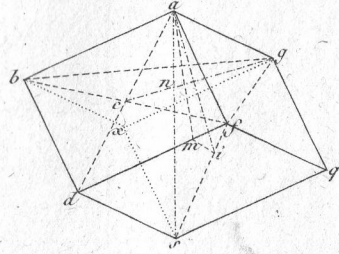


Fig. 10.

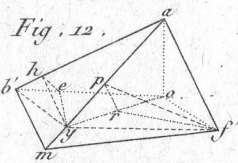
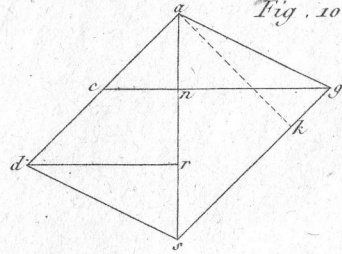


Fig. 12.

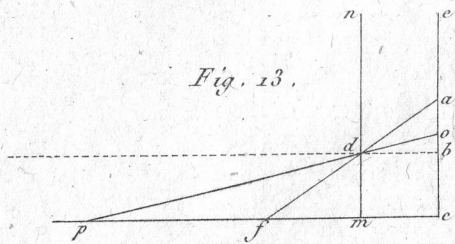


Fig. 13.

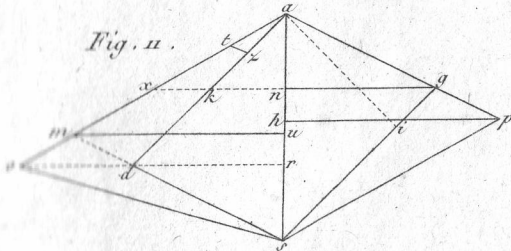
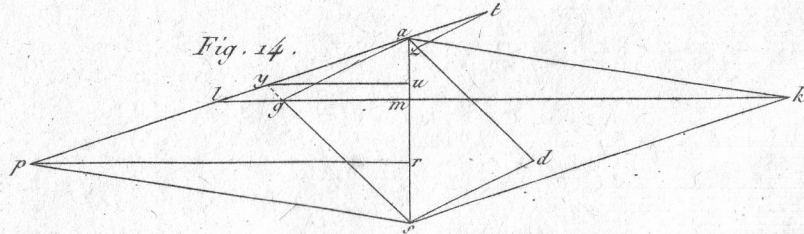
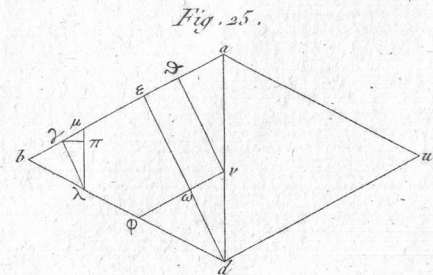
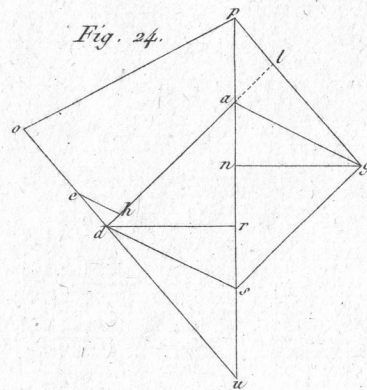
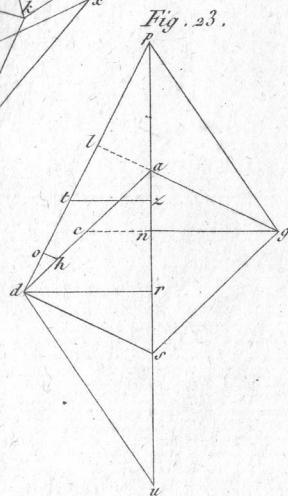
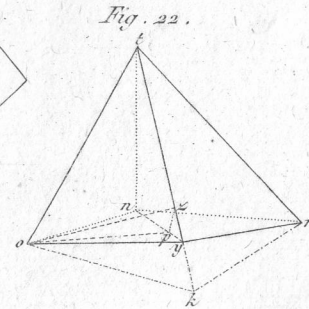
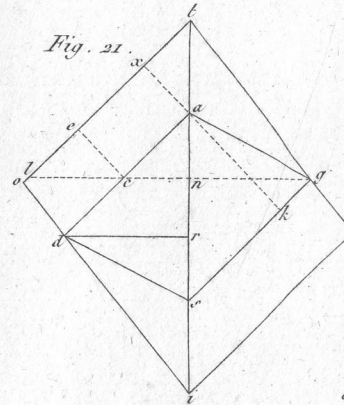
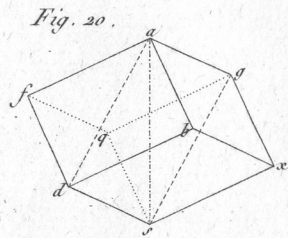
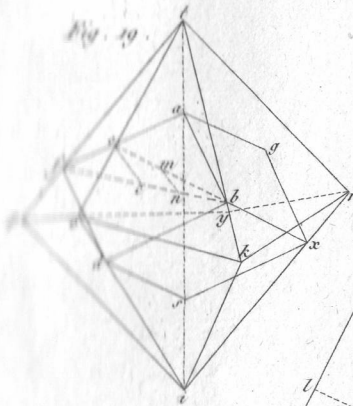
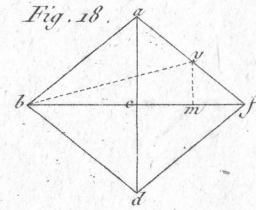
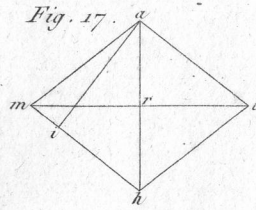
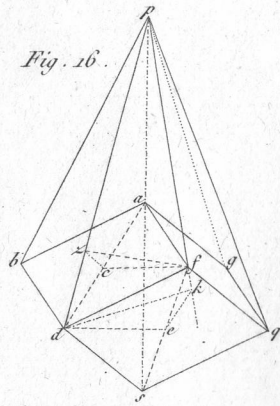
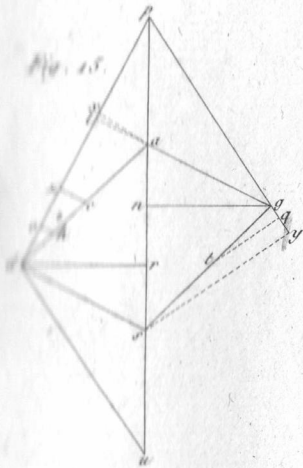
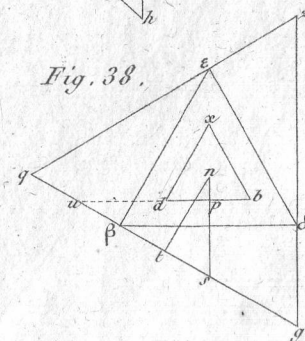
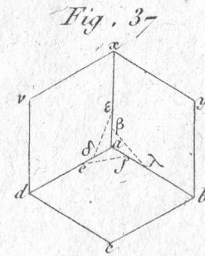
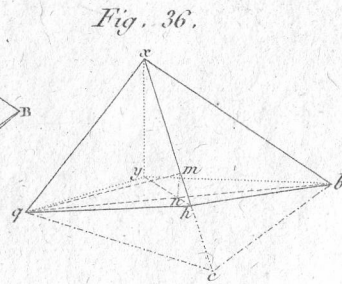
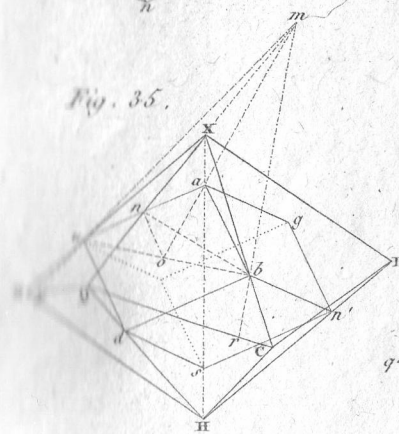
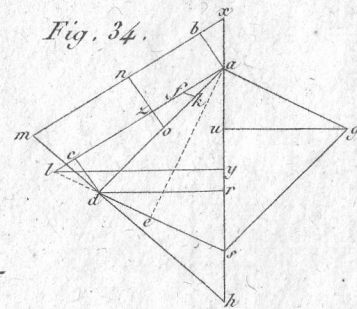
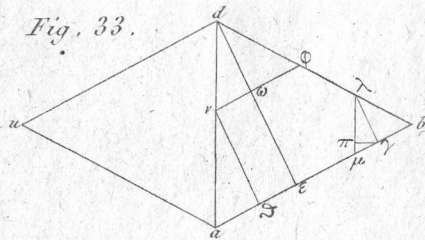
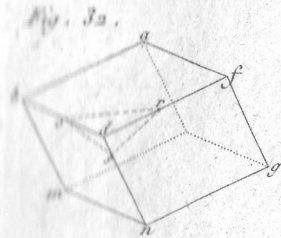
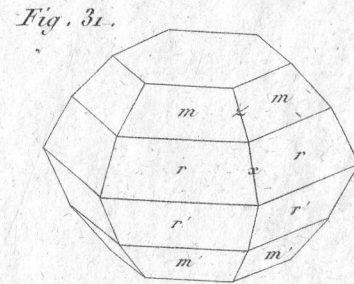
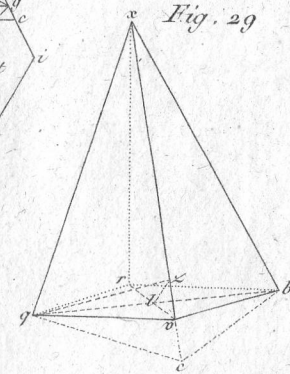
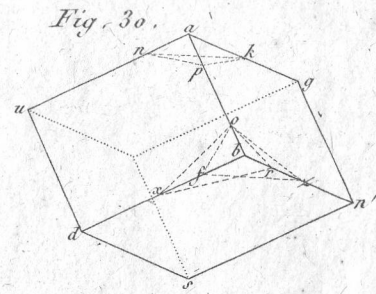
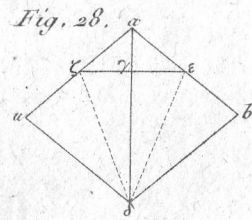
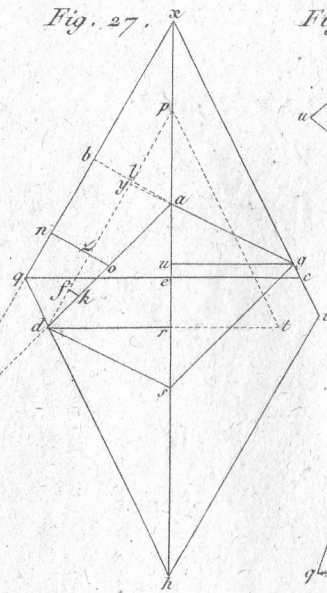
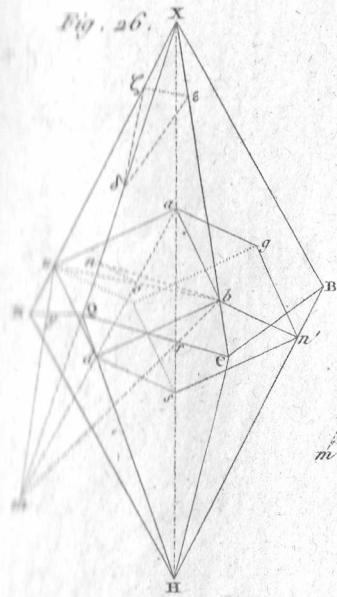


Fig. 14.







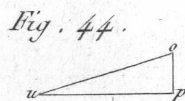
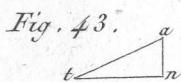
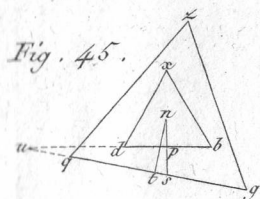
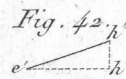
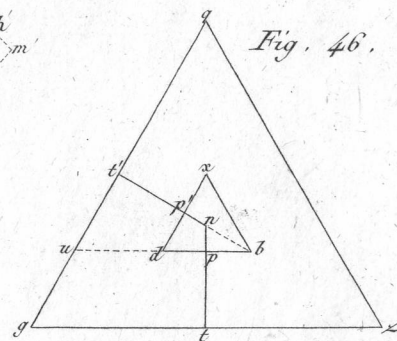
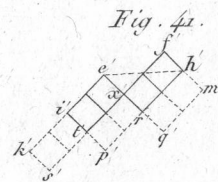
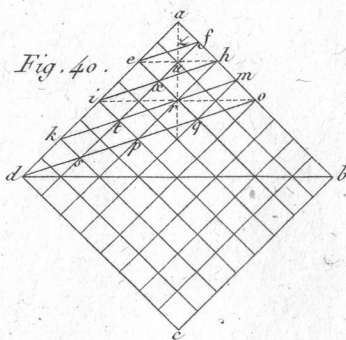
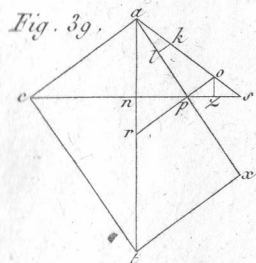


Fig. 47.

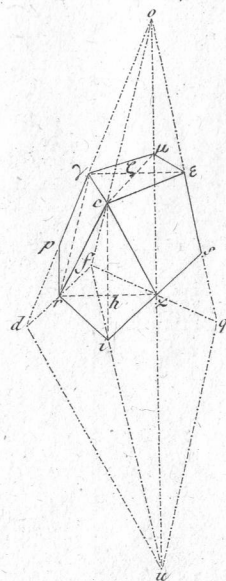


Fig. 48.

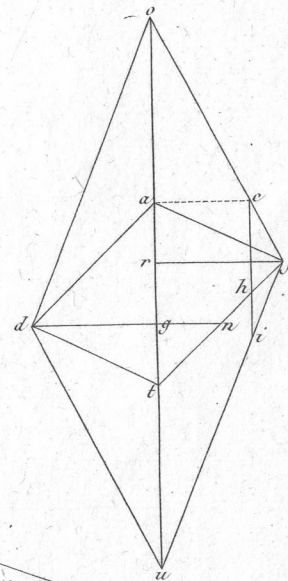


Fig. 49.

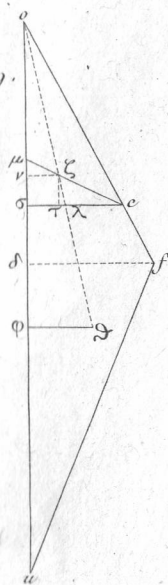


Fig. 50.

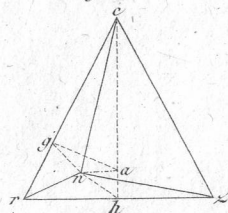


Fig. 51.

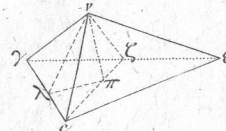


Fig. 52.

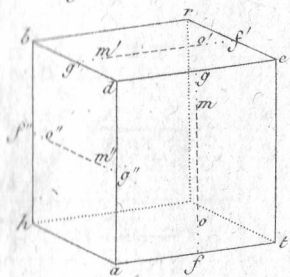


Fig. 53.

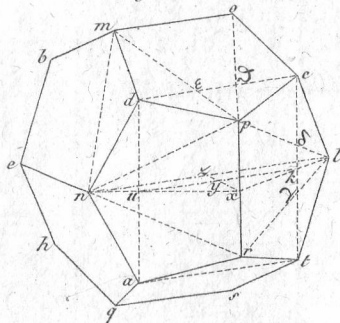


Fig. 54.

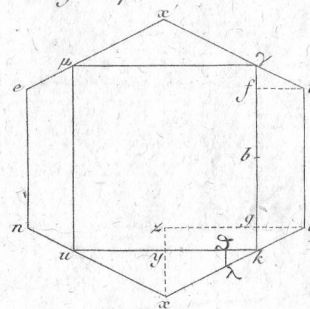


Fig. 55.

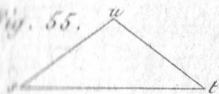


Fig. 56.

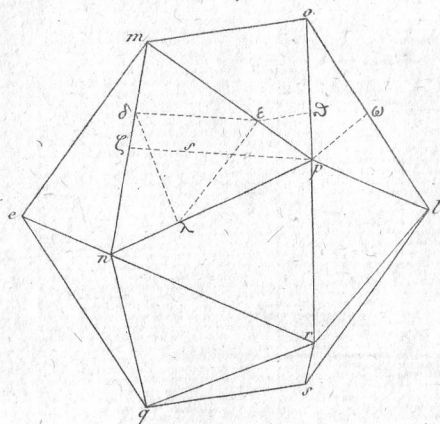


Fig. 58.

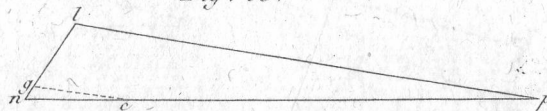


Fig. 57.

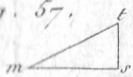


Fig. 59.

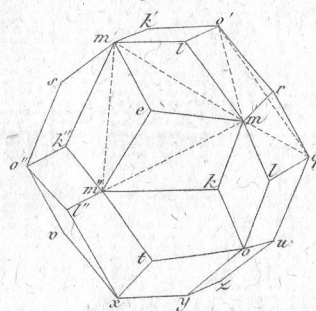


Fig. 60.

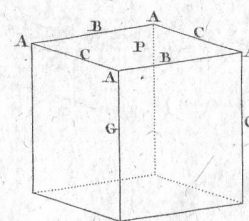


Fig. 61.

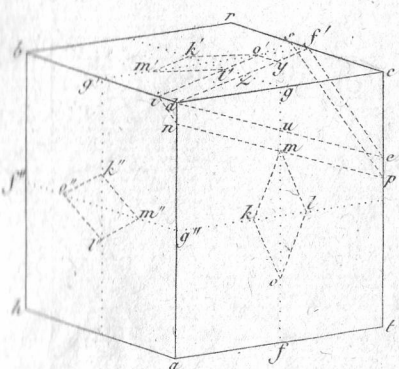


Fig. 62.

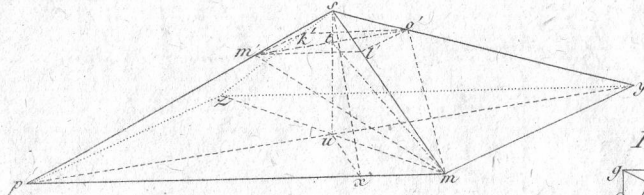


Fig. 63.

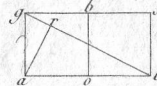


Fig. 64.



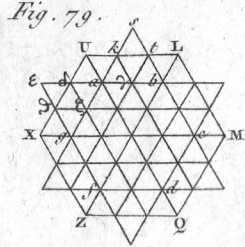
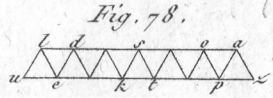
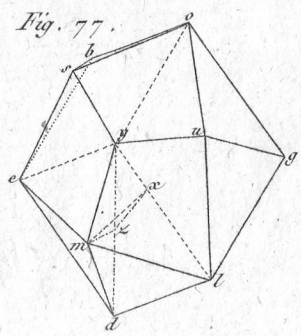
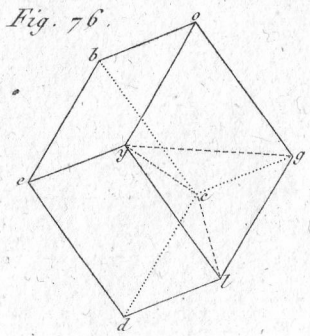
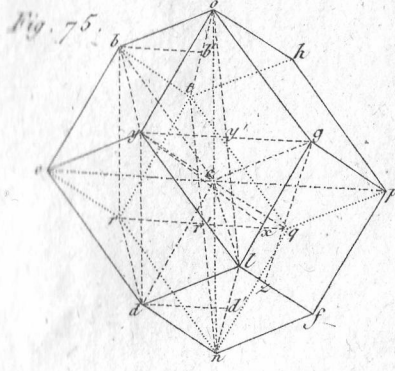
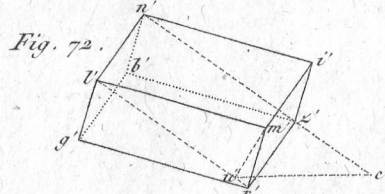
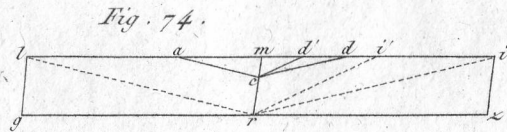
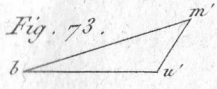
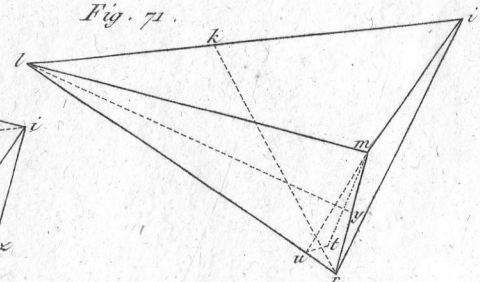
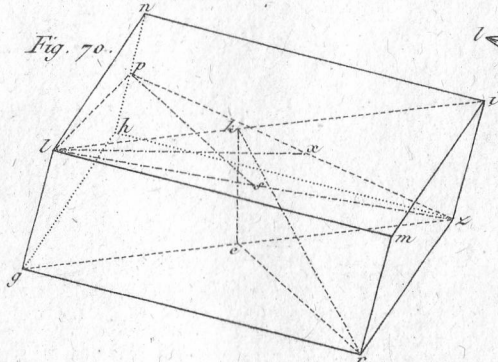
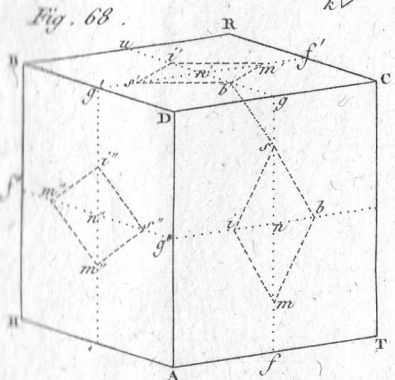
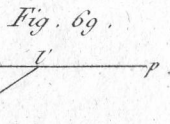
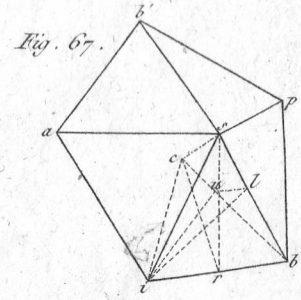
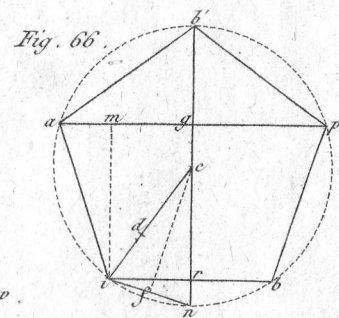
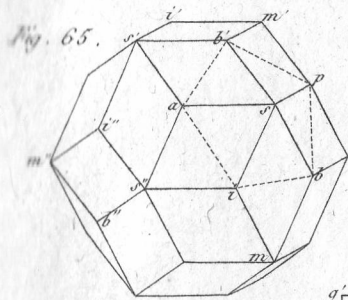


Fig. 80.

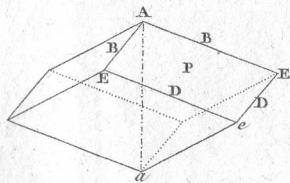


Fig. 81.

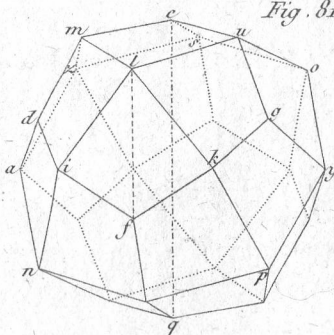


Fig. 82.

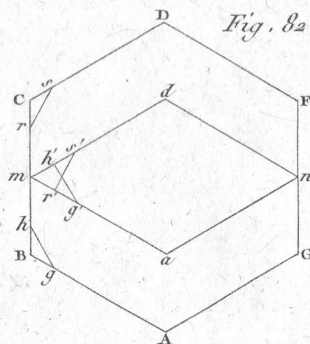


Fig. 83.

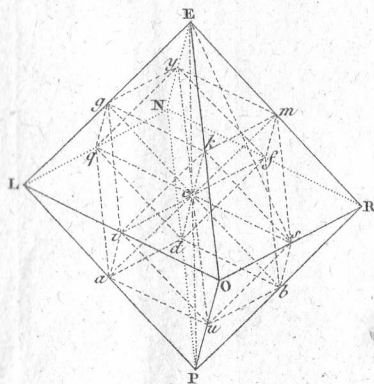


Fig. 84.

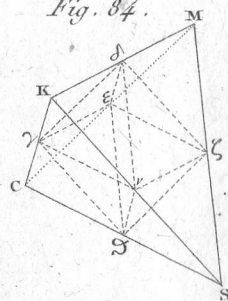


Fig. 85.

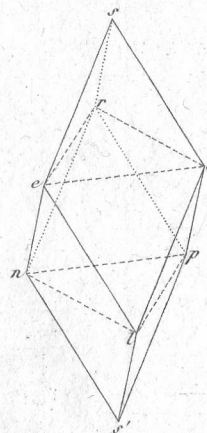


Fig. 87.

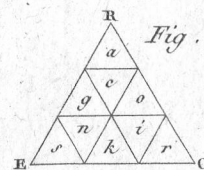


Fig. 86.

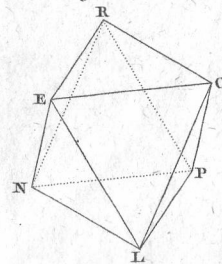


Fig. 88.

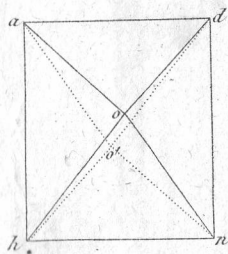


Fig. 89.

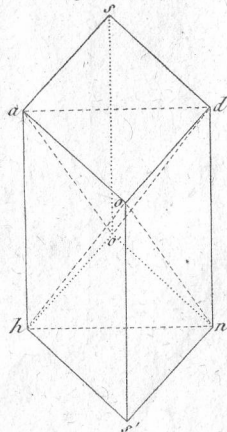


Fig. 90.

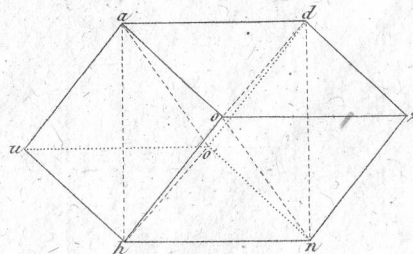
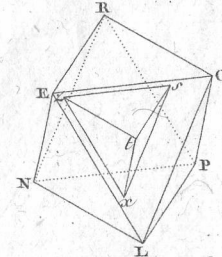


Fig. 91.



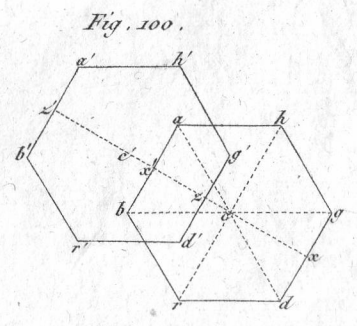
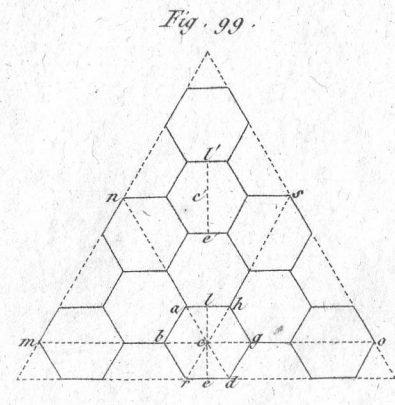
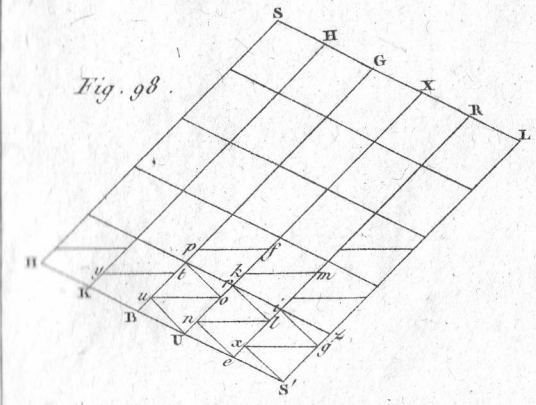
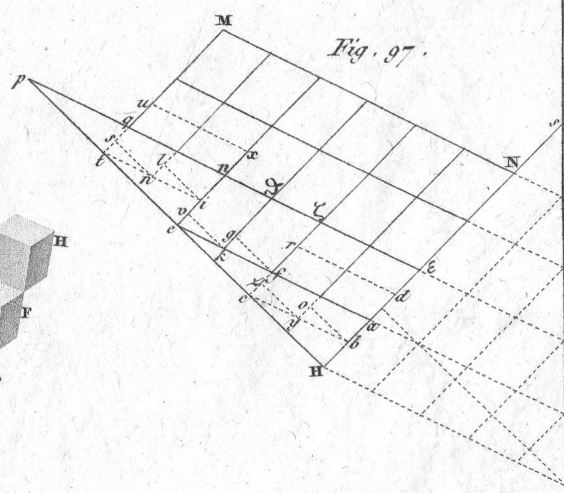
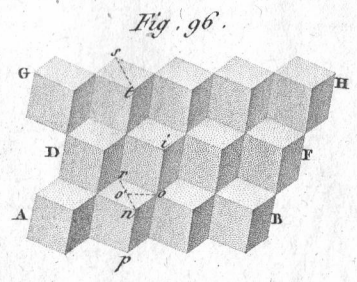
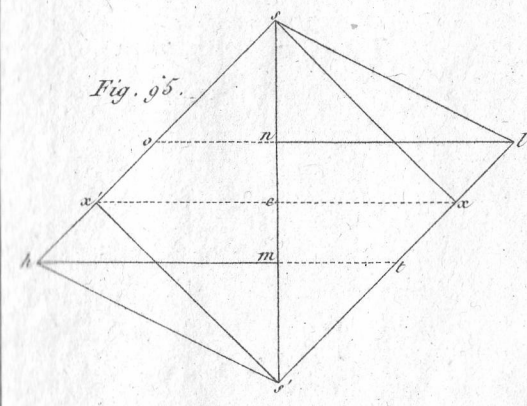
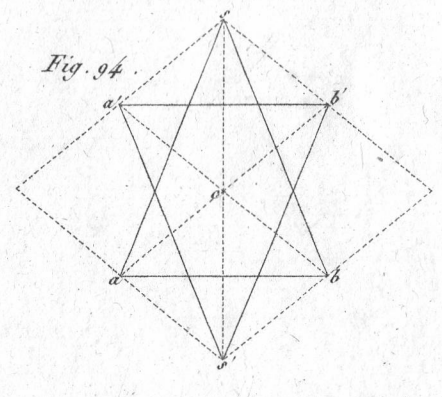
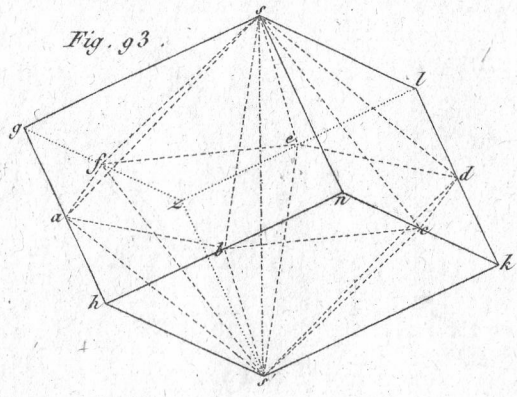
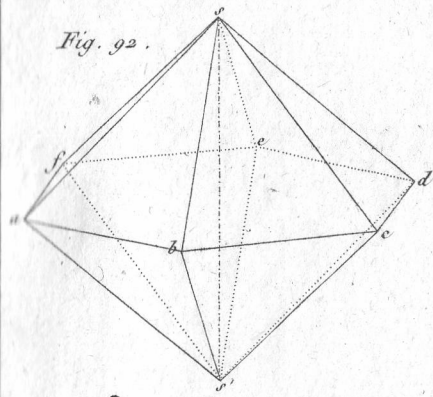


Fig. 101.

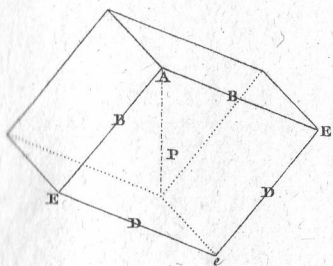


Fig. 102.

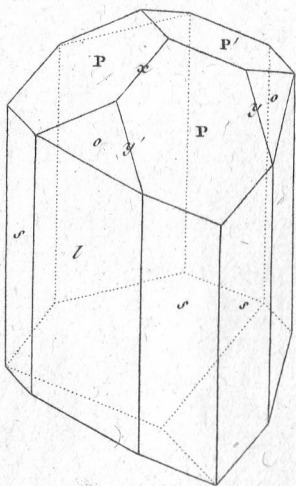


Fig. 103.

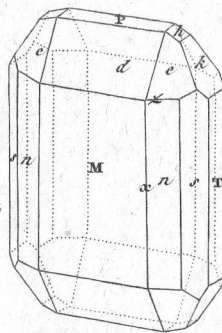


Fig. 104.

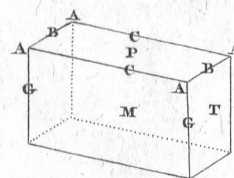


Fig. 105.



Fig. 106.



Fig. 107.

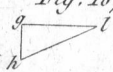


Fig. 111.

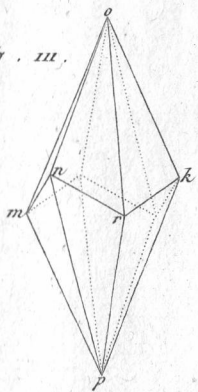


Fig. 108.

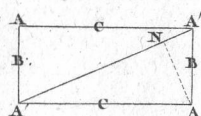


Fig. 109.

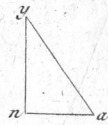


Fig. 110.

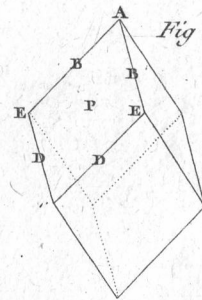


Fig. 112.

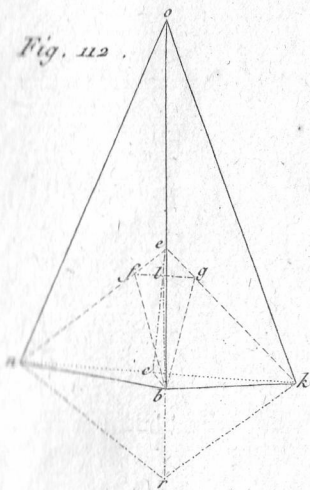


Fig. 113.

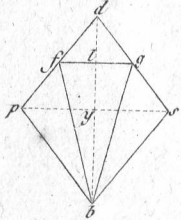


Fig. 115.

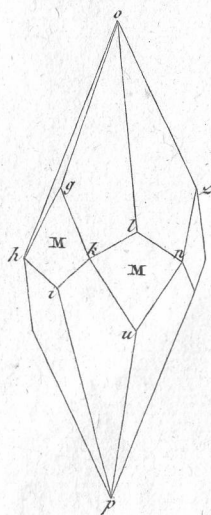


Fig. 114.

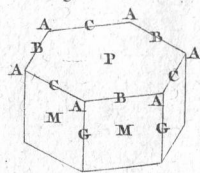
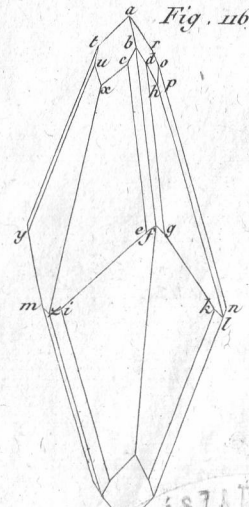


Fig. 116.



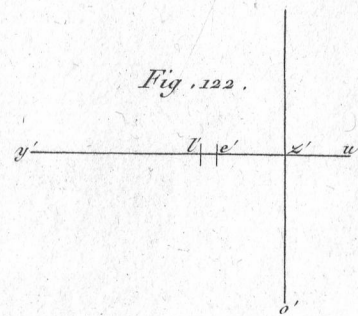
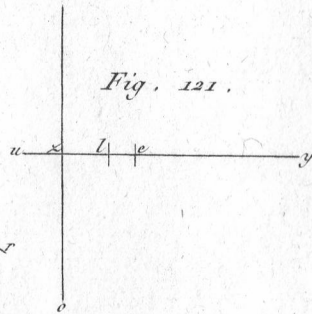
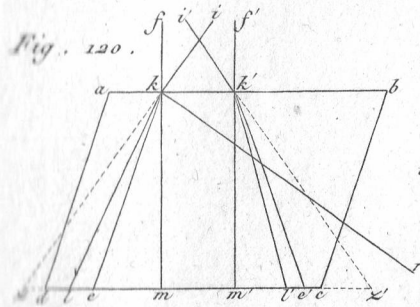
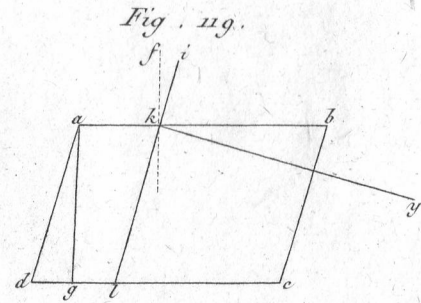
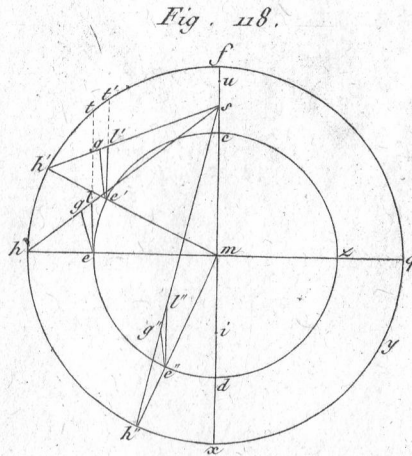
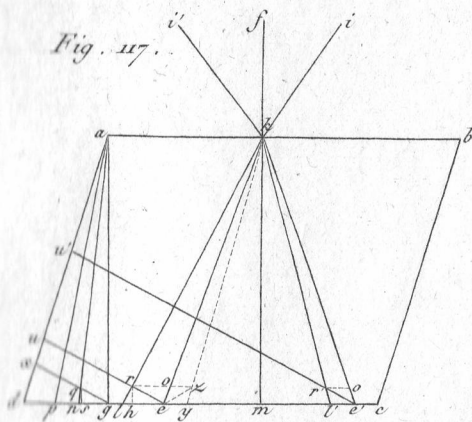


Fig. 123.

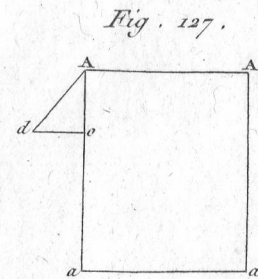
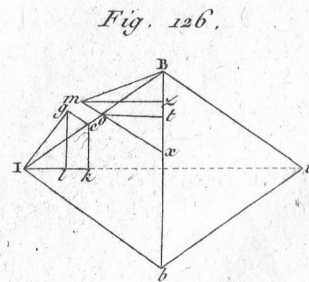
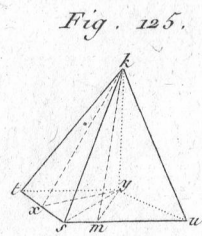
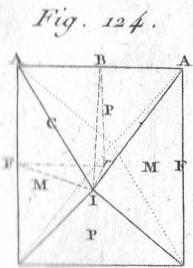
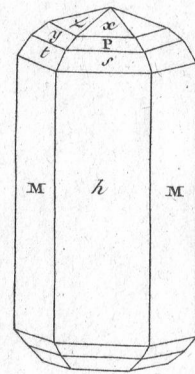


Fig. 128

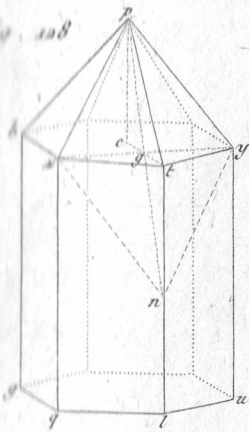


Fig. 129.

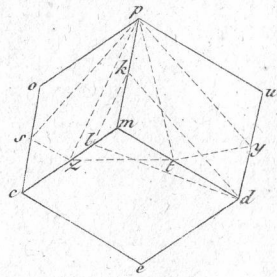


Fig. 130.

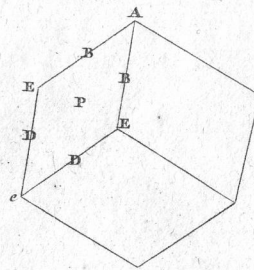


Fig. 131.

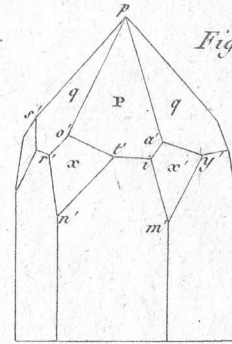


Fig. 132.

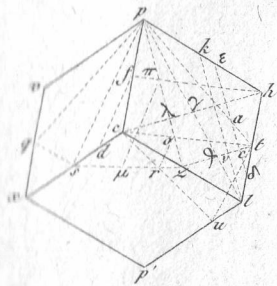


Fig. 133.

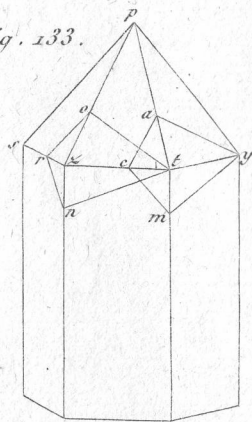


Fig. 134.

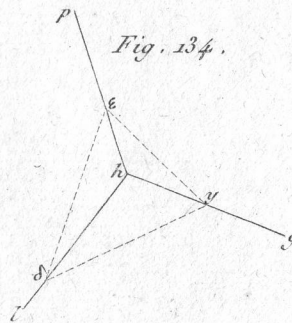


Fig. 135.

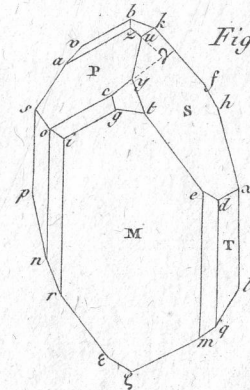


Fig. 136.

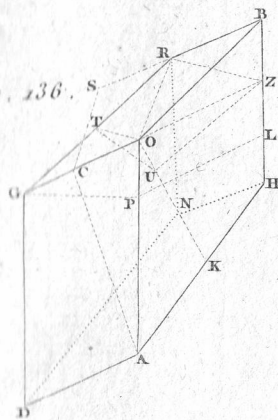


Fig. 137.

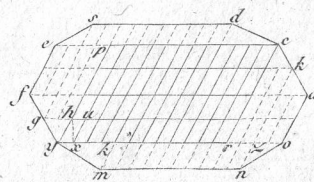


Fig. 138.

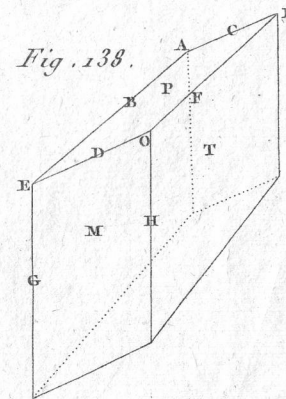


Fig. 139.

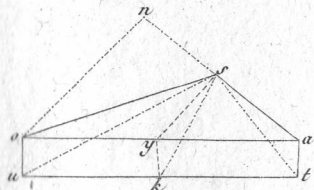


Fig. 140.

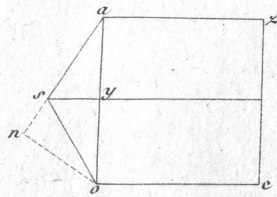


Fig. 141.

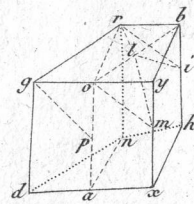


Fig. 142.

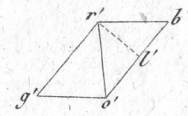


Fig. 143.

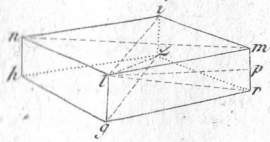


Fig. 144.

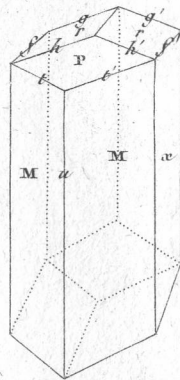


Fig. 145.

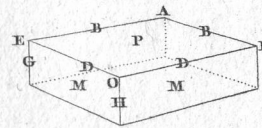


Fig. 146.

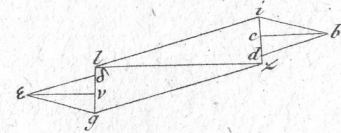


Fig. 147.

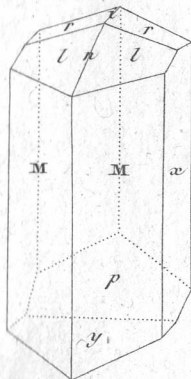


Fig. 148.

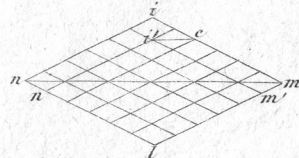


Fig. 149.

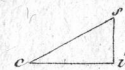


Fig. 150.

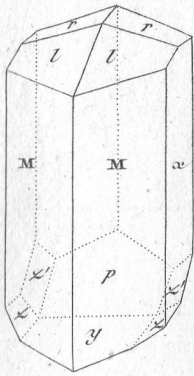


Fig. 151.

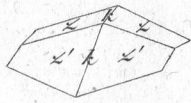


Fig. 152.

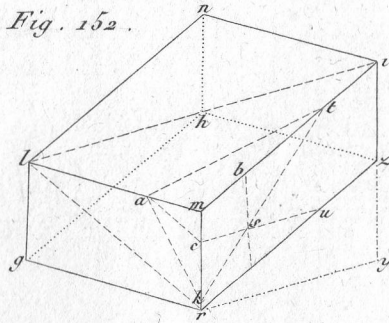


Fig. 153.

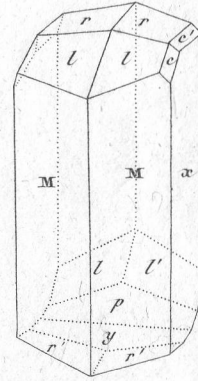


Fig. 154.

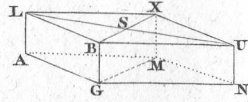


Fig. 155.

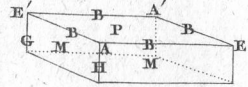


Fig. 156.

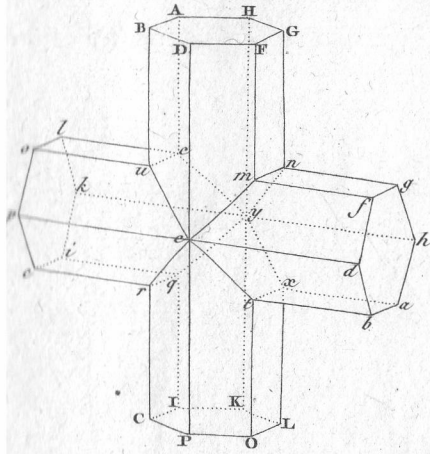


Fig. 157.

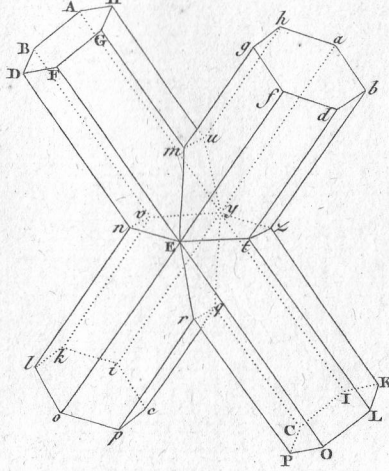


Fig. 158.

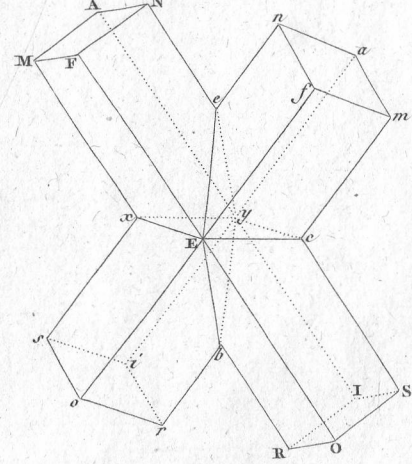


Fig. 159.

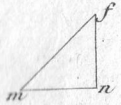


Fig. 160.

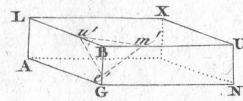


Fig. 161.

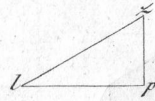
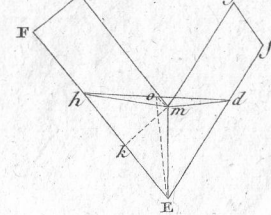


Fig. 162.



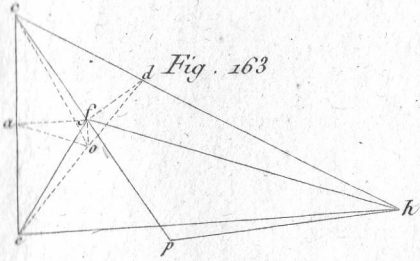


Fig. 163.

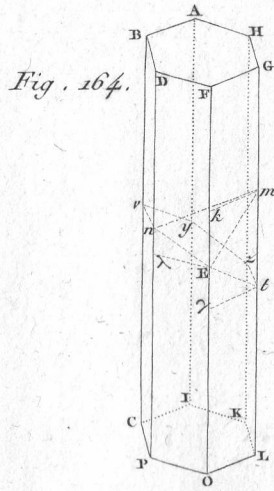


Fig. 164.

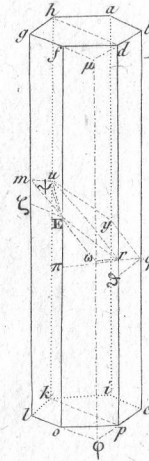


Fig. 165.

Fig. 166.

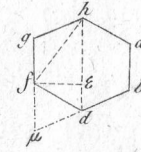


Fig. 168.

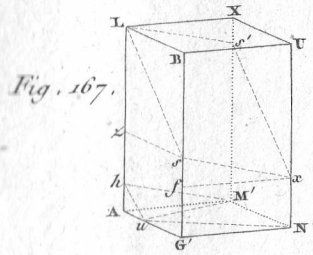
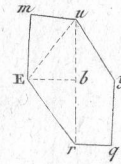


Fig. 167.

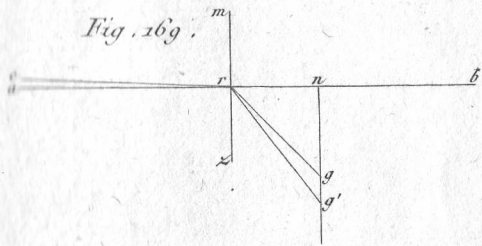


Fig. 169.

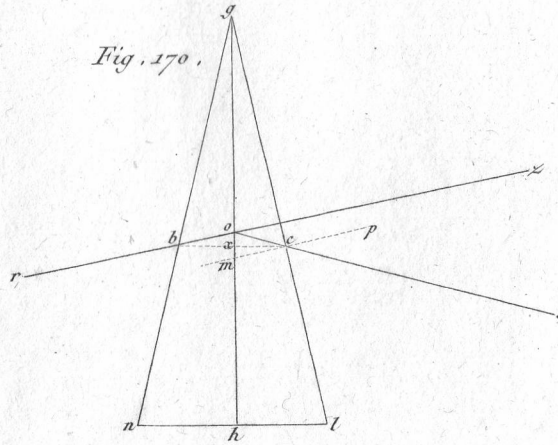


Fig. 170.

Fig. 173.

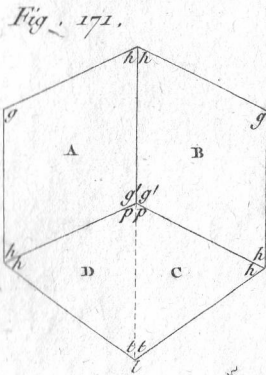
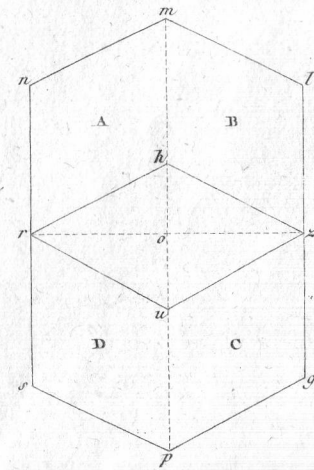


Fig. 171.

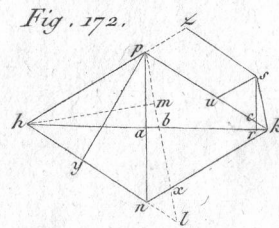


Fig. 172.

CHAUX CARBONATÉE

Fig. 1.

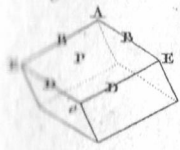


Fig. 2.

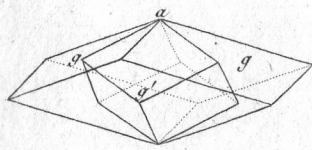


Fig. 3.

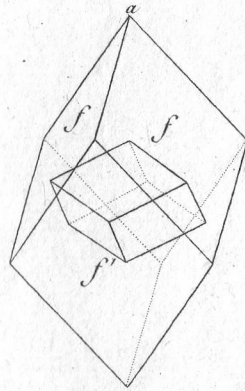


Fig. 4.

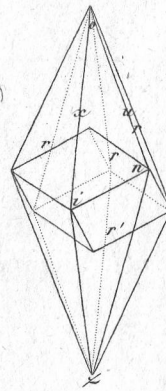


Fig. 5.

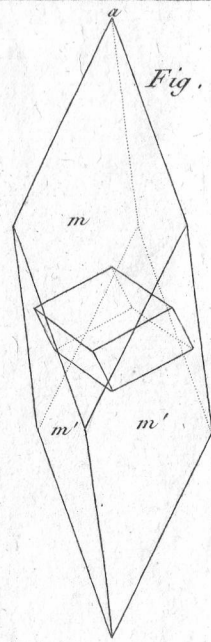


Fig. 6.

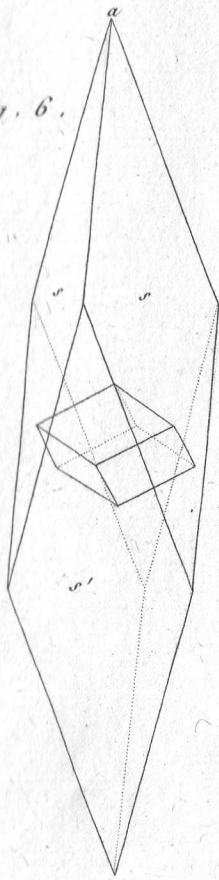


Fig. 7.

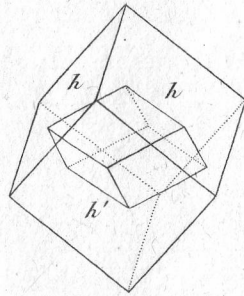


Fig. 8.

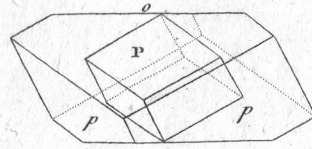
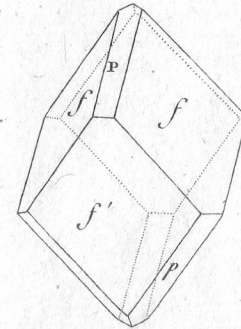


Fig. 9.



Produit de la CHAUX CARBONATÉE

Fig. 10.

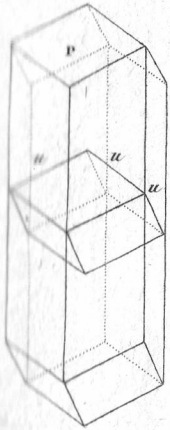


Fig. 11.

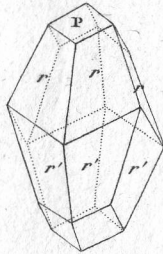


Fig. 12.

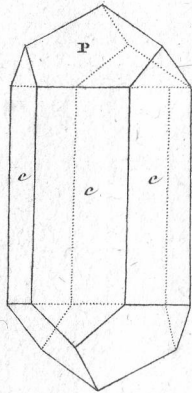


Fig. 13.

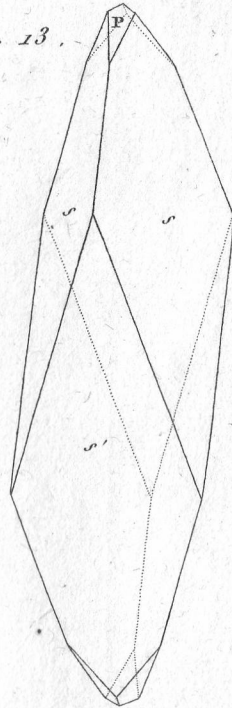


Fig. 14.

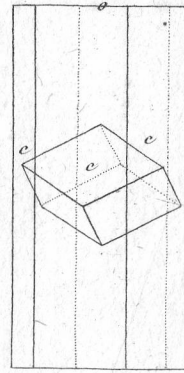


Fig. 15.

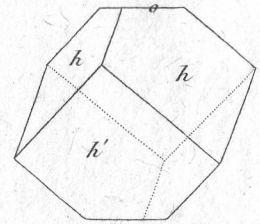


Fig. 16.

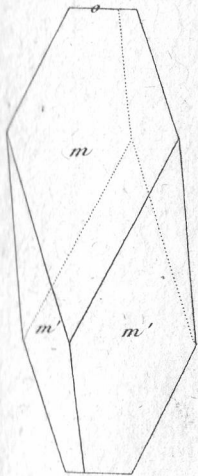


Fig. 17.

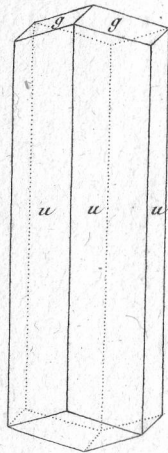


Fig. 18.

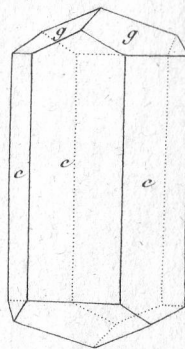


Fig. 19.

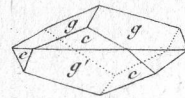


Fig. 20.

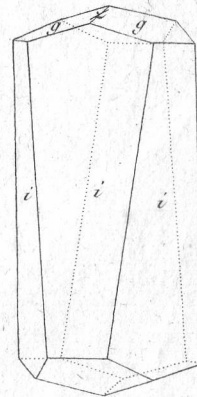
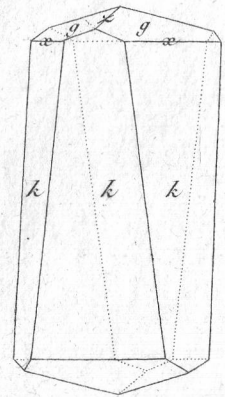


Fig. 21.



Suite de la CHAUX CARBONATÉE

Fig. 22.

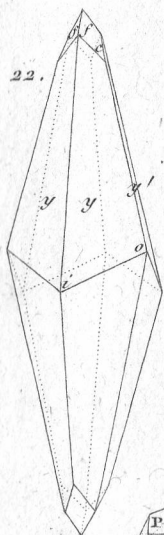


Fig. 23.

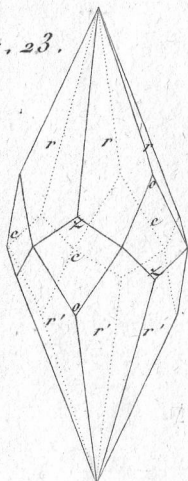


Fig. 24.

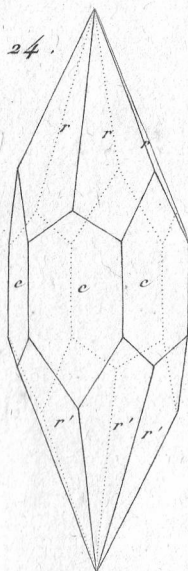


Fig. 25.

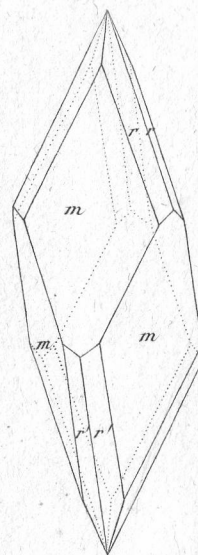


Fig. 26.

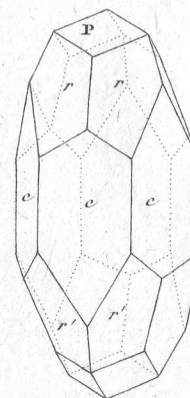


Fig. 27.

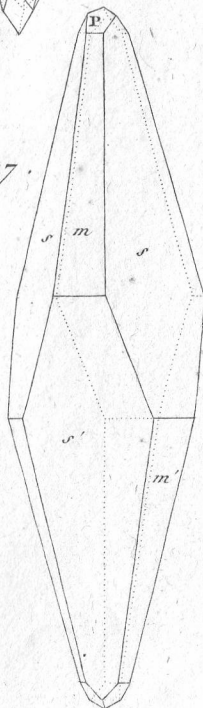


Fig. 28.

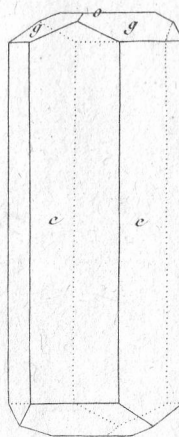


Fig. 29.

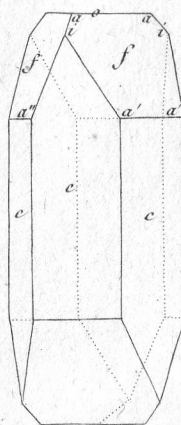


Fig. 30.

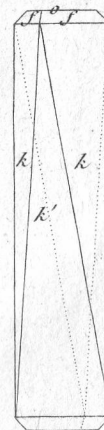
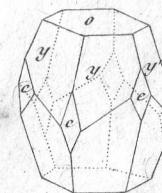


Fig. 31.



Suite de la CHAUX CARBONATÉE

Fig. 32.

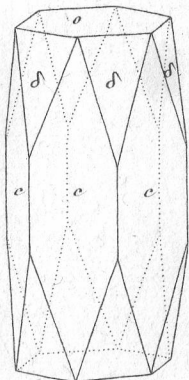


Fig. 33.

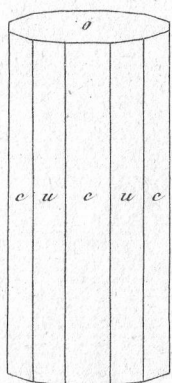


Fig. 34.

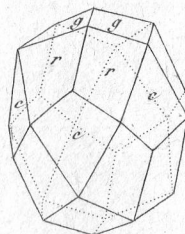


Fig. 35.

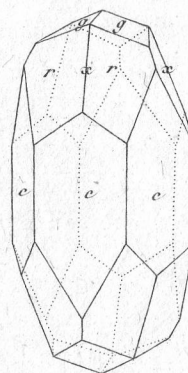


Fig. 36.

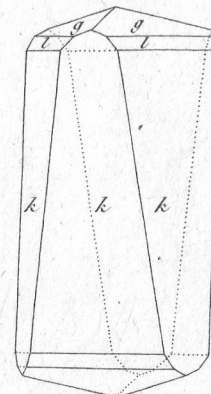


Fig. 37.

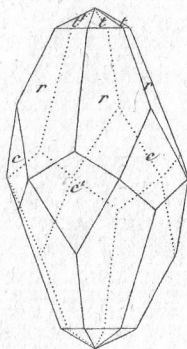


Fig. 38.

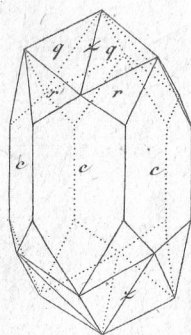


Fig. 39.

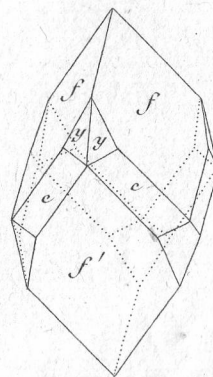
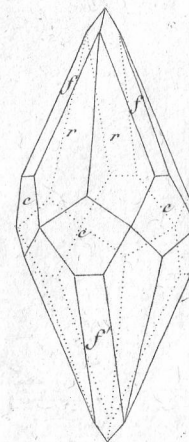


Fig. 40.



Suite de la CHAUX CARBONATÉE

Fig. 41.

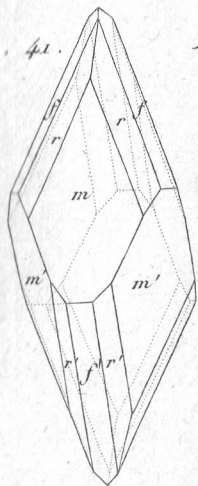


Fig. 42.

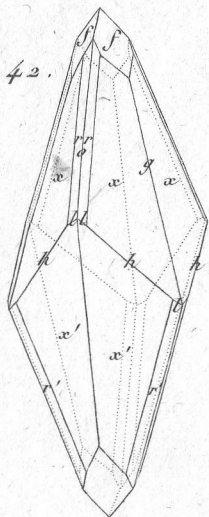


Fig. 43.

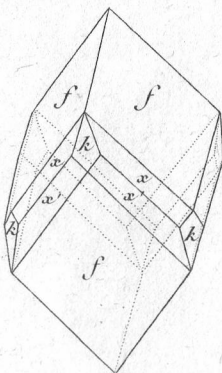


Fig. 44.

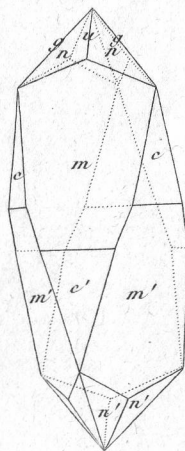


Fig. 45.

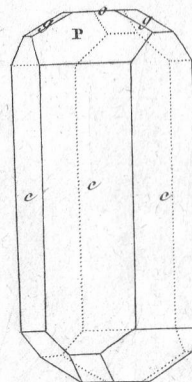


Fig. 46.

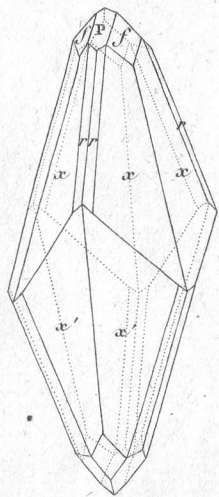


Fig. 47.

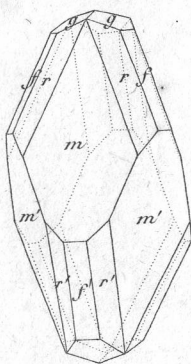


Fig. 48.

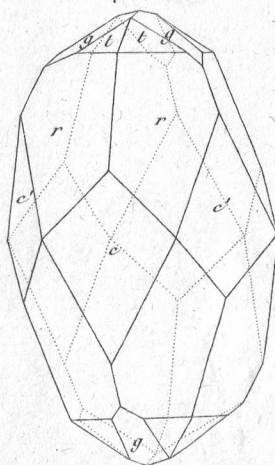
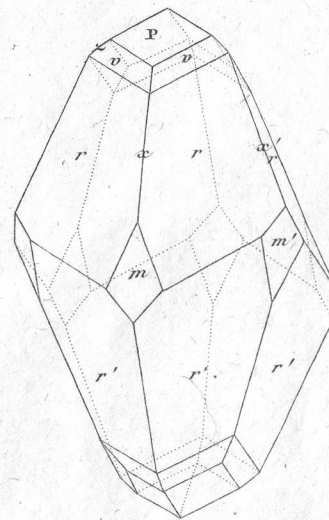


Fig. 49.



Suite de la CHAUX CARBONATÉE

DOUBLE REFRACTION

Fig. 50.

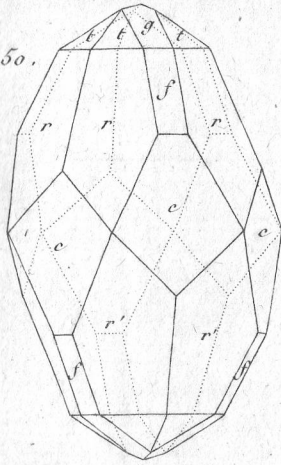


Fig. 51.

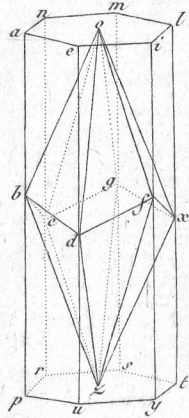


Fig. 52.

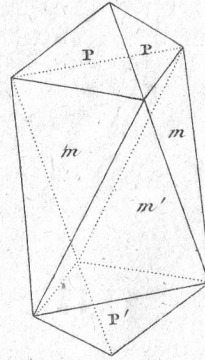


Fig. 53.

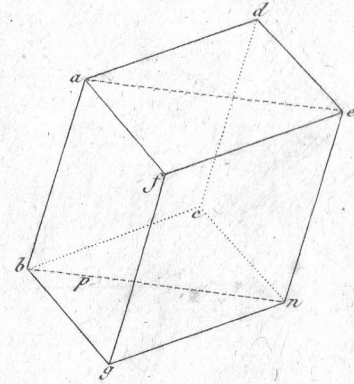


Fig. 54.

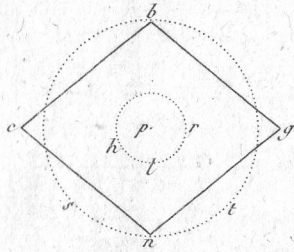


Fig. 57.

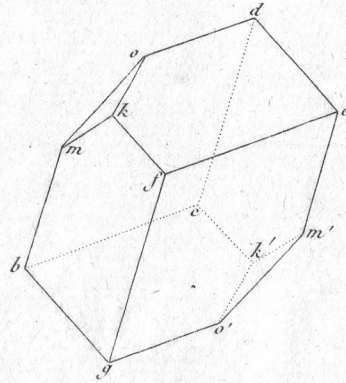


Fig. 55.

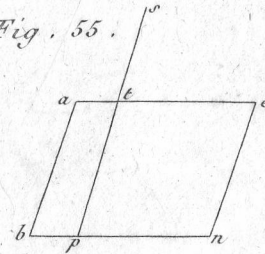


Fig. 56.

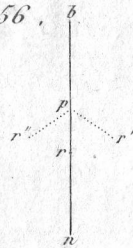
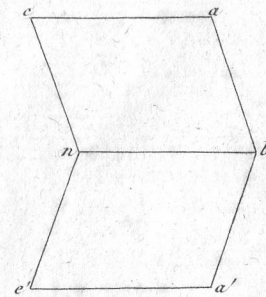


Fig. 58.



Suite de la CHAUX CARBONATÉE

Fig. 59.

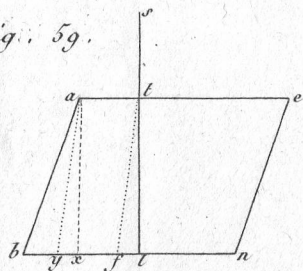


Fig. 60.

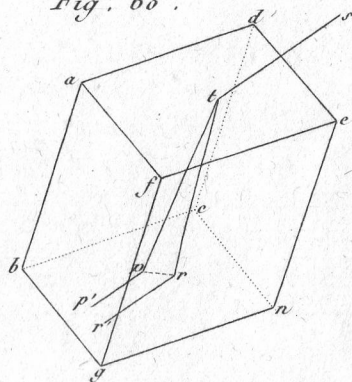


Fig. 61.

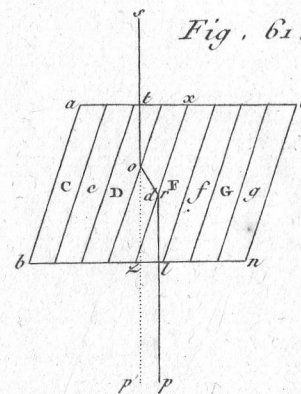


Fig. 63.

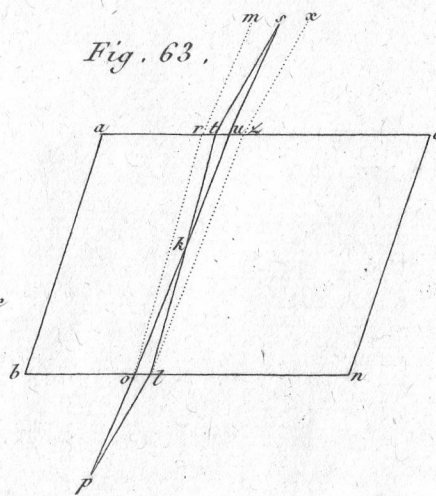


Fig. 64.

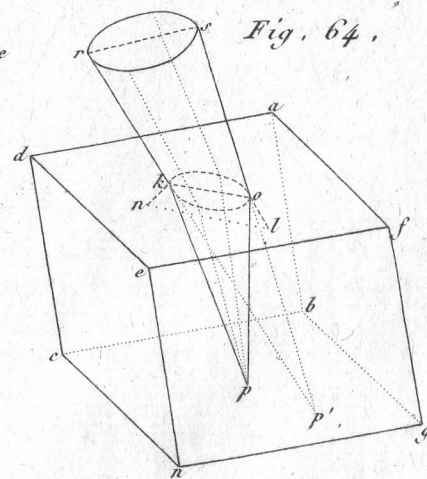


Fig. 62.

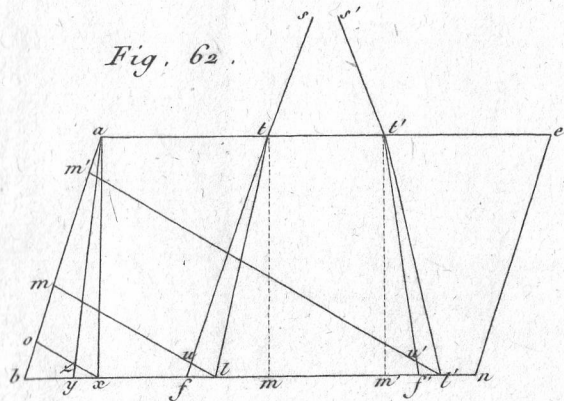
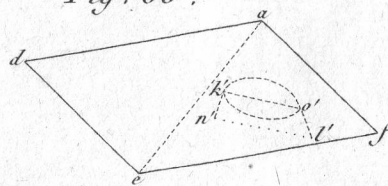


Fig. 65.



CHAUX PHOSPHATÉE

Fig. 66.

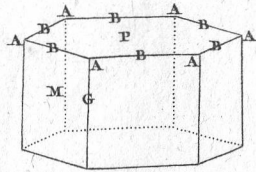


Fig. 67.

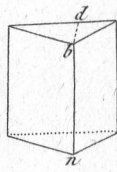


Fig. 68.

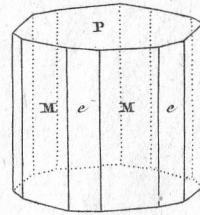


Fig. 69.

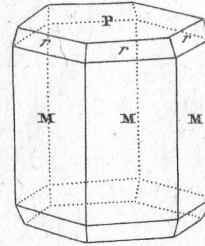


Fig. 70.

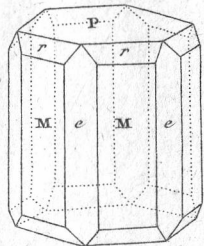


Fig. 71.

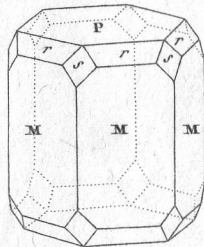


Fig. 72.

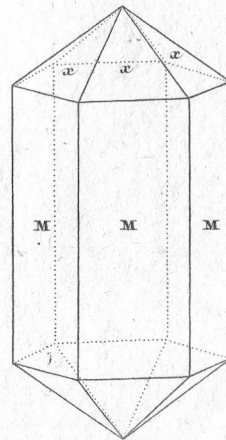
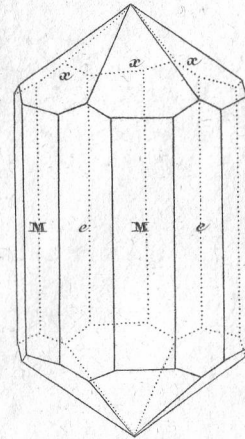


Fig. 73.



CHAUX FLUATÉE

Fig. 74.

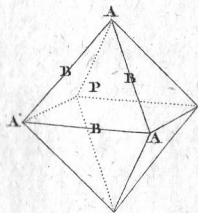


Fig. 75.

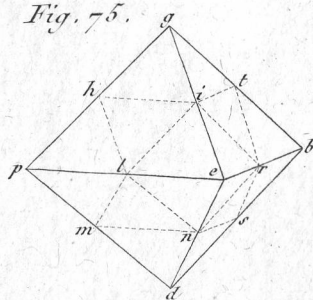


Fig. 76.

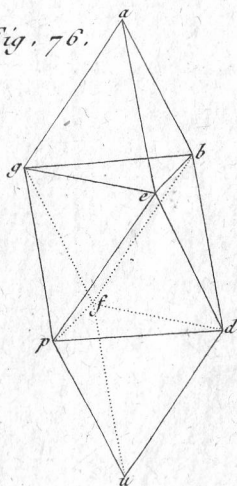


Fig. 77.

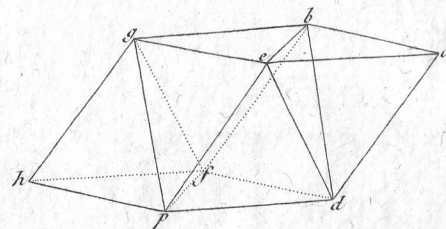


Fig. 78.

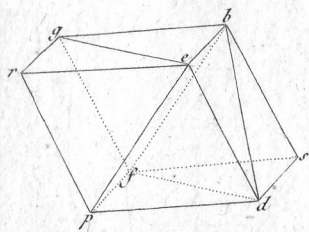


Fig. 79.

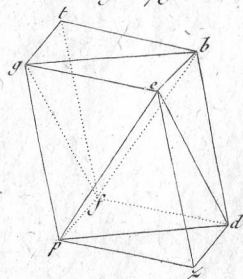


Fig. 80.

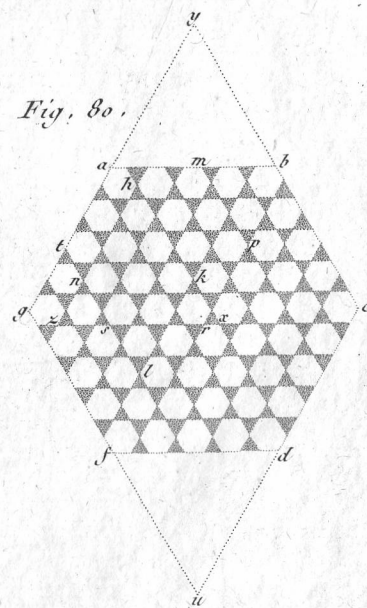


Fig. 81.

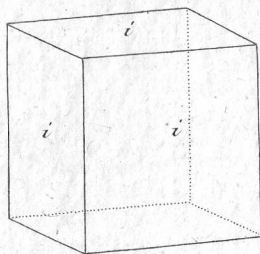
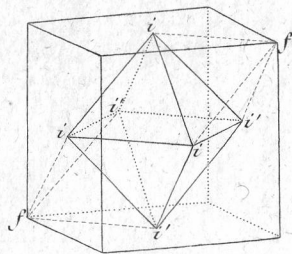


Fig. 82.



Suite de la CHAUX FLUATÉE

Fig. 83.

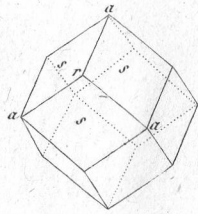


Fig. 84.

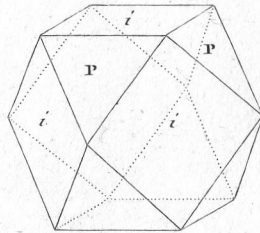


Fig. 85.

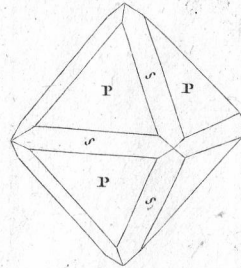


Fig. 86.

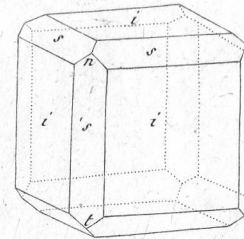


Fig. 87.

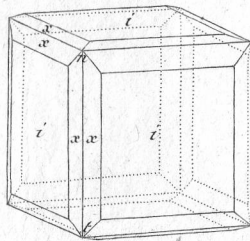


Fig. 88.

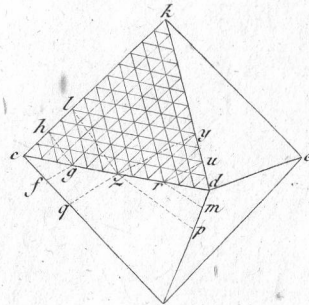


Fig. 89.

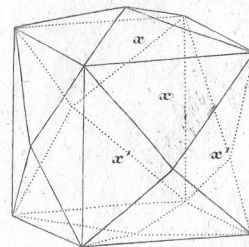
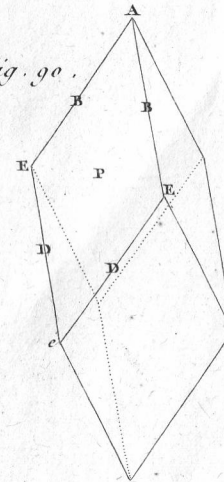


Fig. 90.



MAGNESIE BORATEE

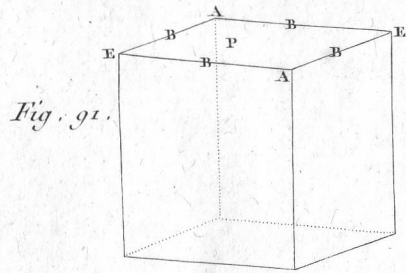


Fig. 91.

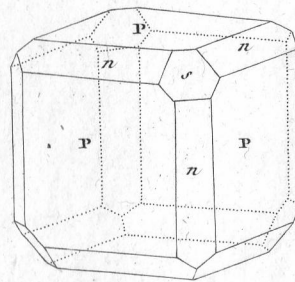


Fig. 92.

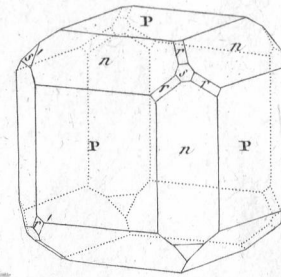


Fig. 93.

CHAUX SULFATEE

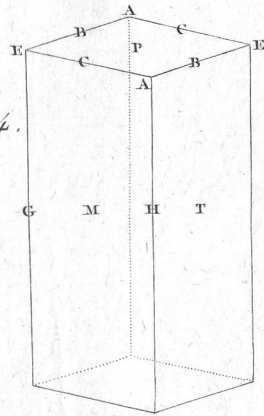


Fig. 94.

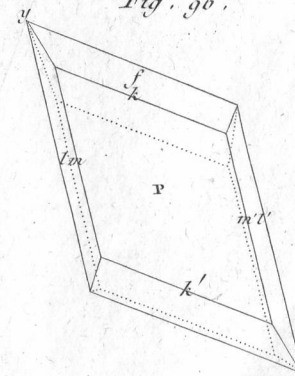
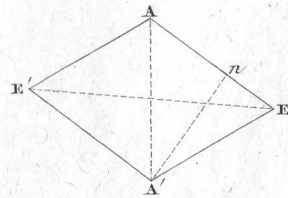


Fig. 96.

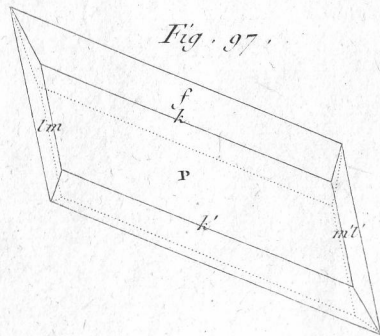


Fig. 97.

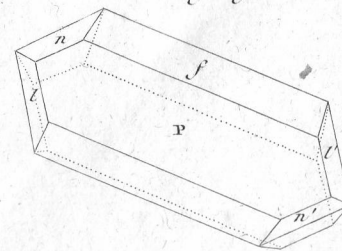


Fig. 98.

Suite de la CHAUX SULFATEE

Fig. 99.

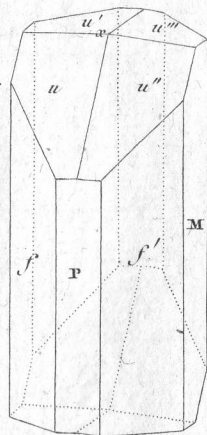


Fig. 100.

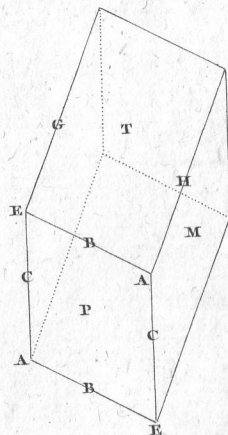


Fig. 101.

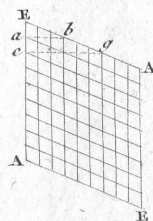


Fig. 102.

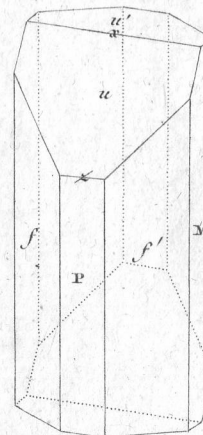


Fig. 103.

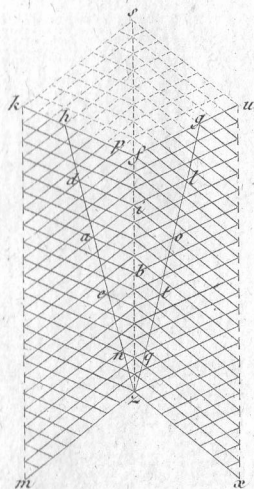


Fig. 104.

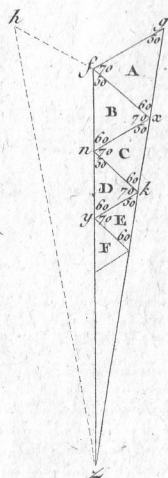


Fig. 105.

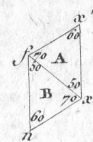
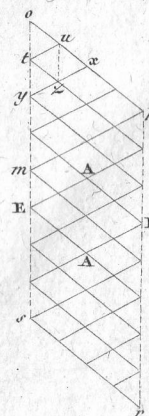


Fig. 106.



BARYTE SULFATÉE

Fig. 107.

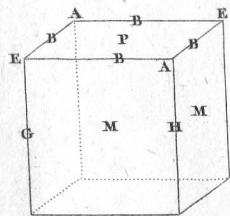


Fig. 108.

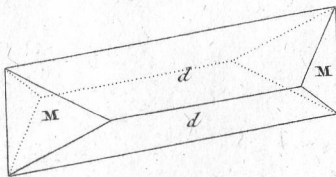


Fig. 109.

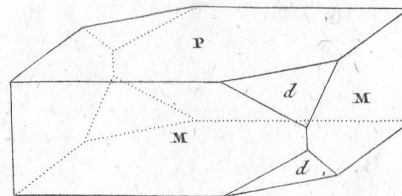


Fig. 110.

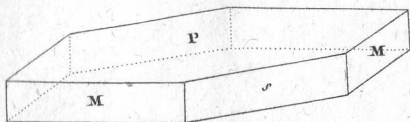


Fig. 111.

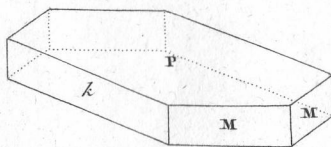


Fig. 112.

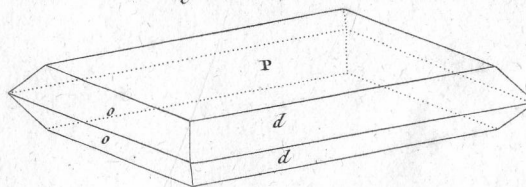


Fig. 113.

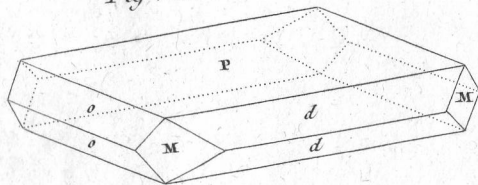


Fig. 114.

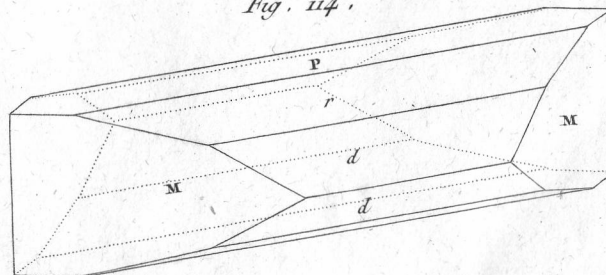


Fig. 115.

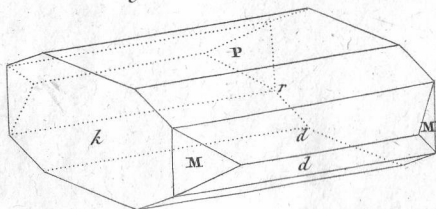
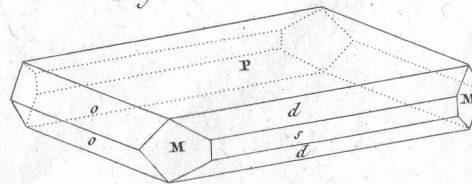


Fig. 116.



Suite de la BARYTE SULFATÉE

Fig. 117.

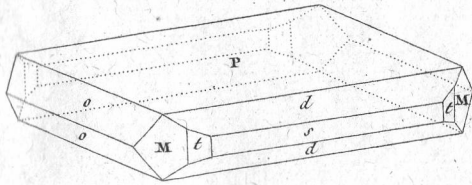


Fig. 118.

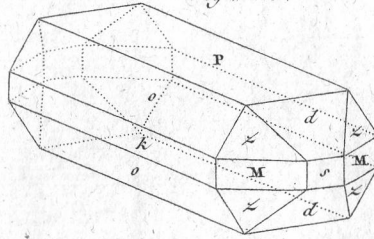
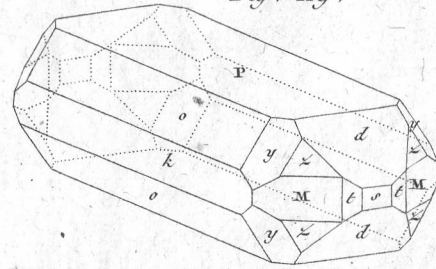


Fig. 119.



STRONTIANE SULFATÉE

Fig. 120.

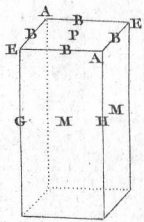


Fig. 121.

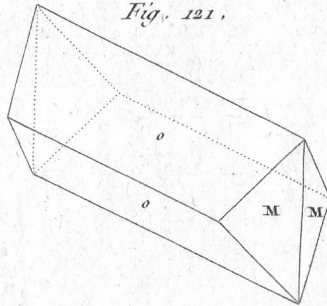


Fig. 122.

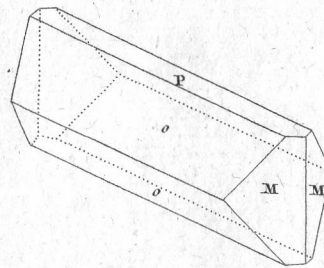


Fig. 123.

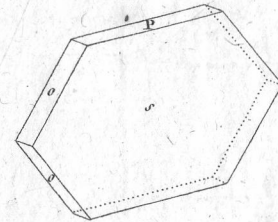


Fig. 124.

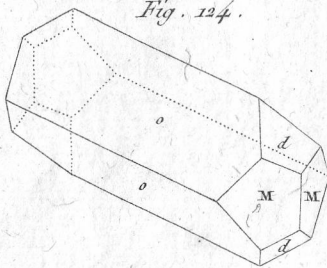


Fig. 125.

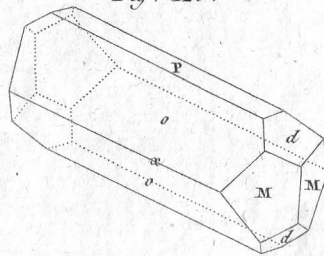
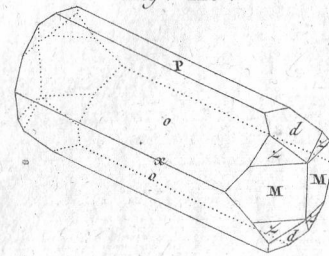


Fig. 126.



Suite de la STRONTIANE SULFATÉE

Fig. 127.

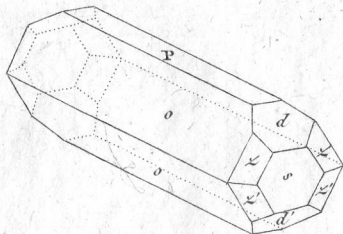


Fig. 128.

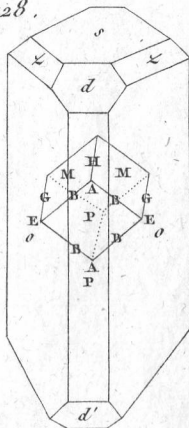


Fig. 129.

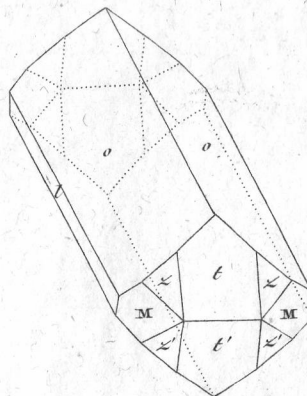
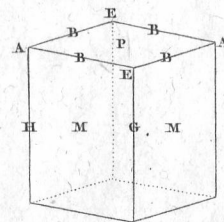


Fig. 130.



MAGNESIE SULFATÉE

Fig. 131.

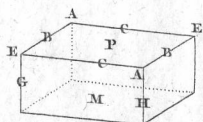


Fig. 132.

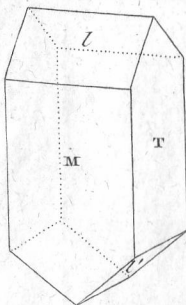


Fig. 133.

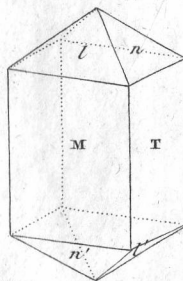


Fig. 134.

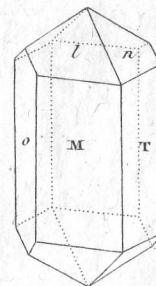


Fig. 135.

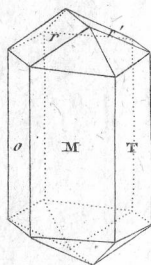


Fig. 136.

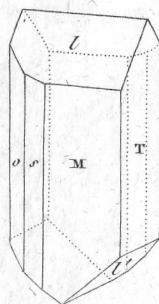
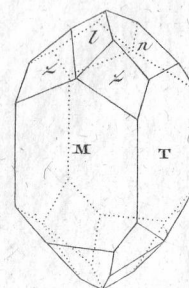


Fig. 137.





POTASSE NITRATÉE

Fig. 138.

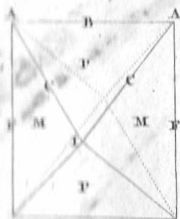


Fig. 139.

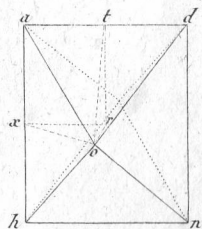


Fig. 140.

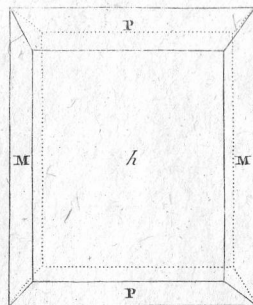


Fig. 141.

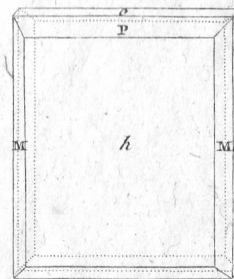


Fig. 142.

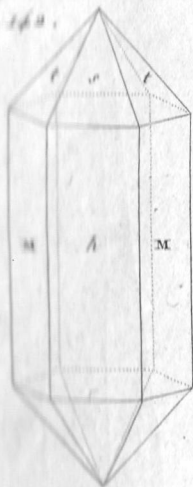


Fig. 143.

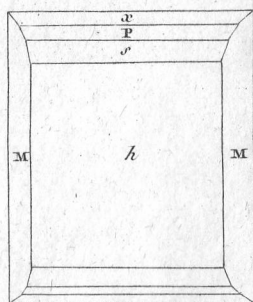
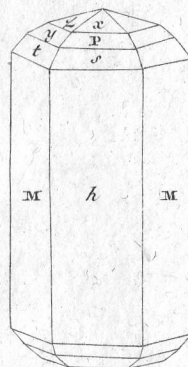


Fig. 144.



SOUDE MURIATÉE

Fig. 145.

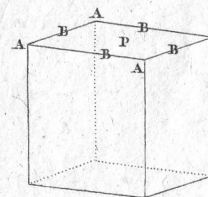
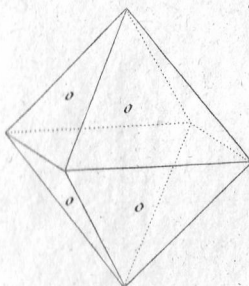


Fig. 147.



SOUDE BORATÉE

Fig. 148.

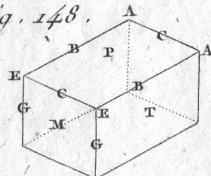


Fig. 149.

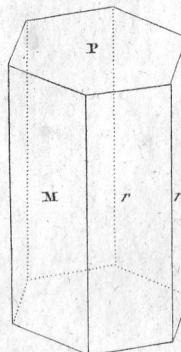


Fig. 150.

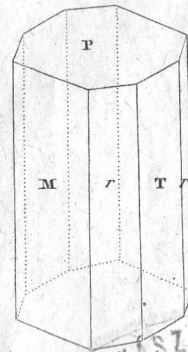
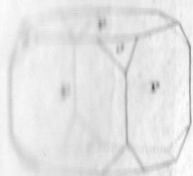


Fig. 146.



M. K. BANYASZATI
ÉS ERDESEZETI AKADEMIA
KÖNYVTÁRA

Suite de la SOUDE BORATÉE - Fig. 152.

Fig. 153.

Fig. 151.

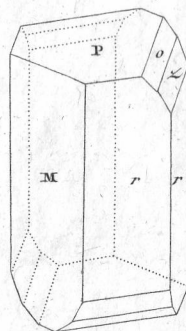
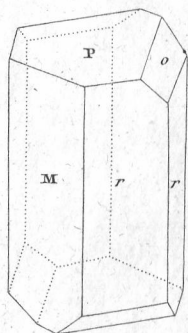
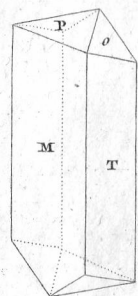
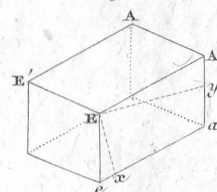


Fig. 154.



SOUDE CARBONATÉE

AMMONIAQUE MURIATÉE

Fig. 157.

Fig. 158.

Fig. 155.

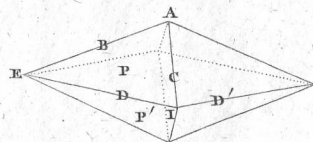
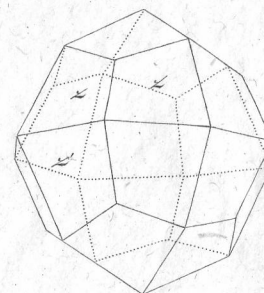
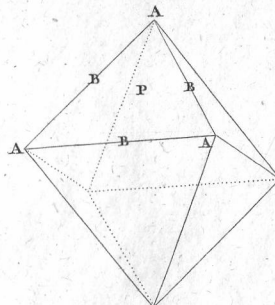
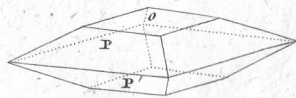


Fig. 156.



ALUMINE SULFATÉE ALKALINE

Fig. 159.

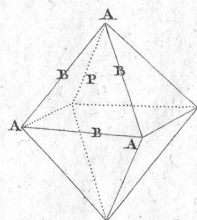


Fig. 160.

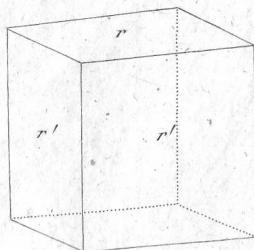


Fig. 161.

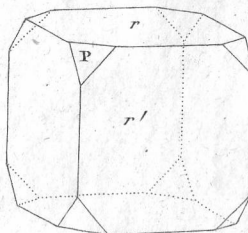
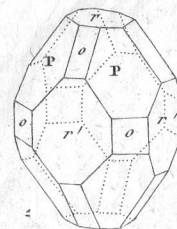


Fig. 162.



QUARTZ

Fig. 1.

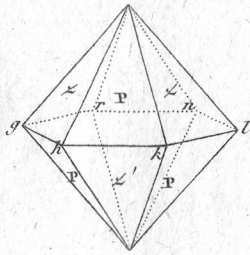


Fig. 2.

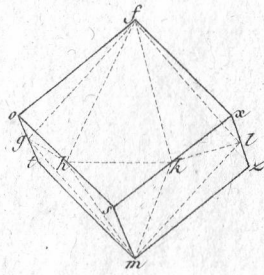


Fig. 3.

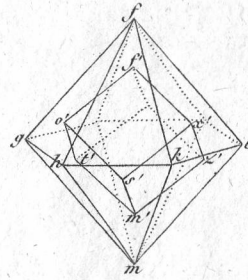


Fig. 4.

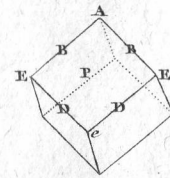


Fig. 5.

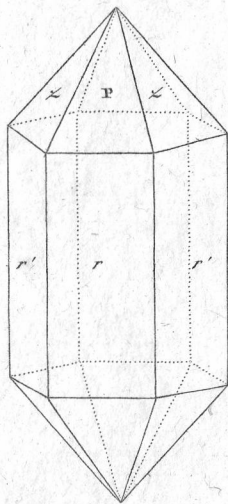


Fig. 6.

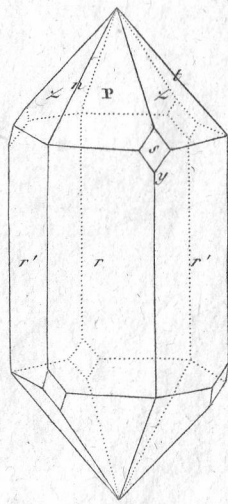


Fig. 7.

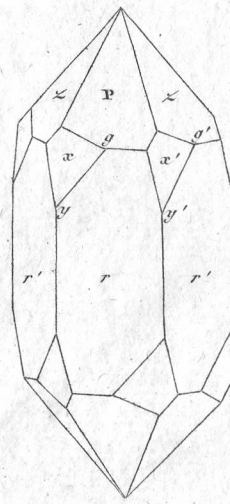
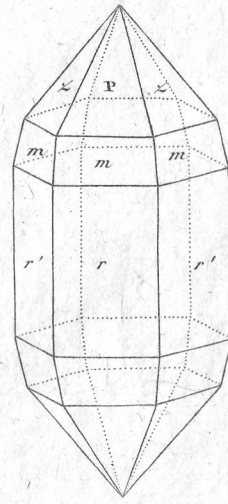


Fig. 8.



ZIRCON

Fig. 9.

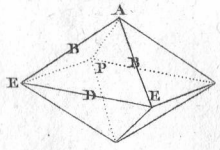


Fig. 10.

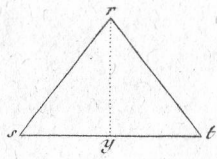


Fig. 12.

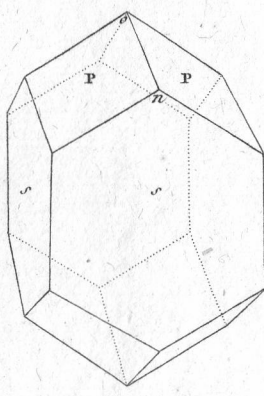


Fig. 13.

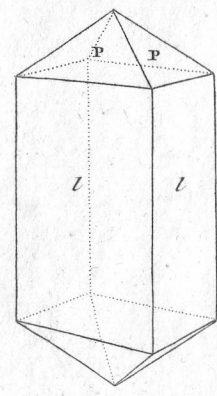


Fig. 14.

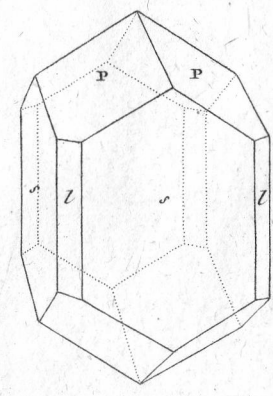


Fig. 11.

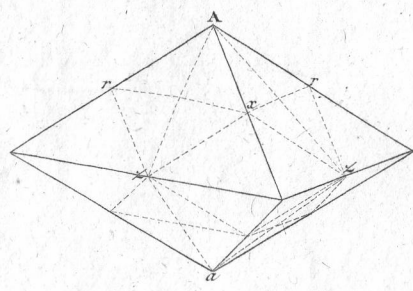


Fig. 15.

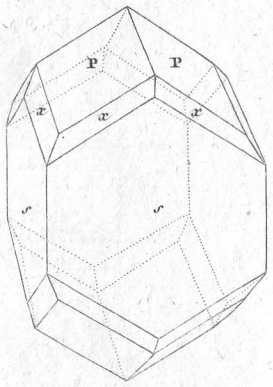


Fig. 16.

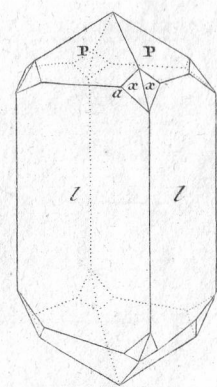


Fig. 17.

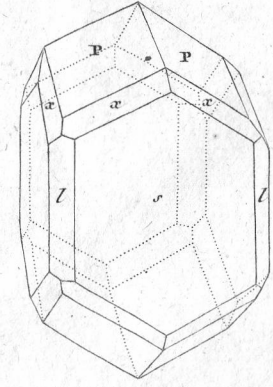
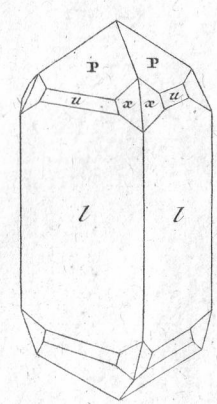


Fig. 18.



TELESIE

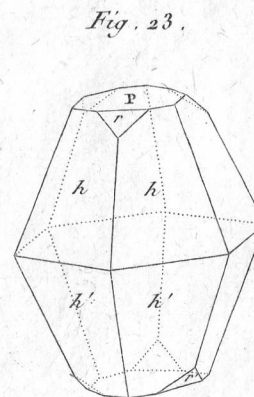
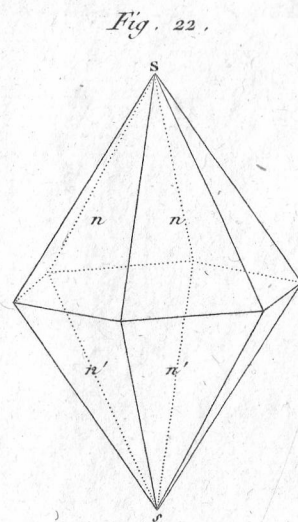
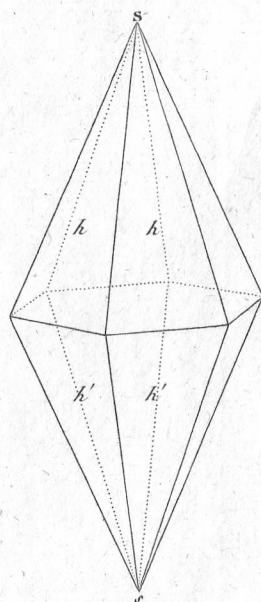
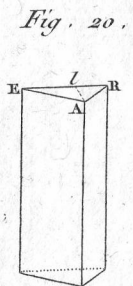
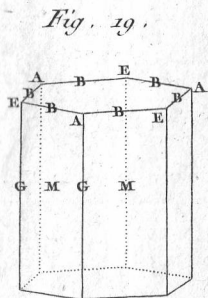
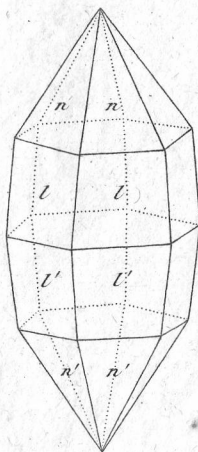


Fig. 24.



CYMOPHANE

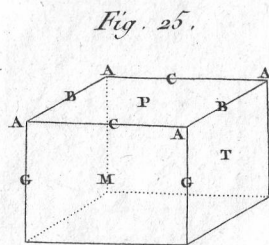


Fig. 26.

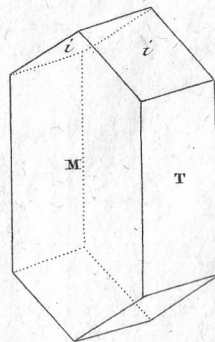
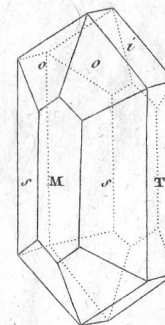


Fig. 27.



Suite de la CYMOPHANE

SPINELLE

Fig. 28.

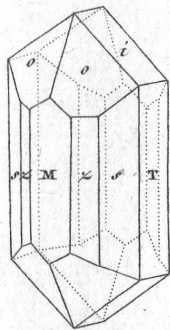


Fig. 29.

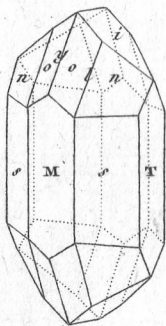


Fig. 30.

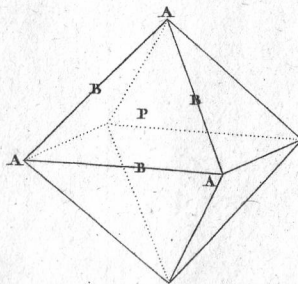


Fig. 31.

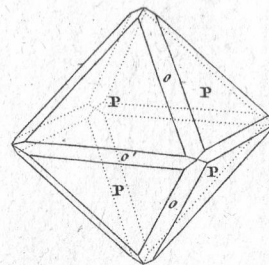


Fig. 32.

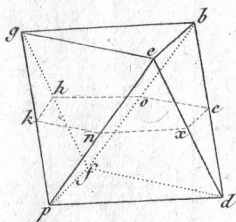


Fig. 33.

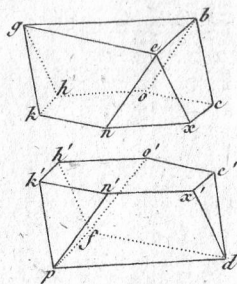


Fig. 34.

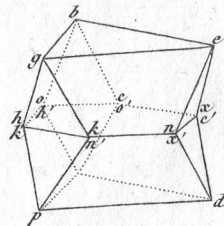
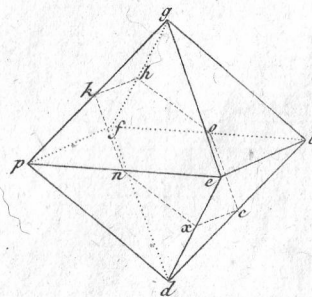


Fig. 35.



TOPAZE Fig. 36.

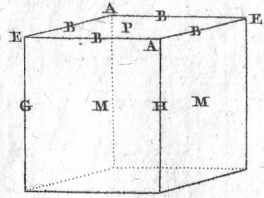


Fig. 37.

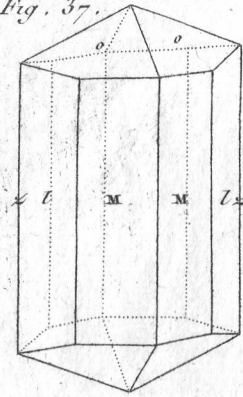


Fig. 38.

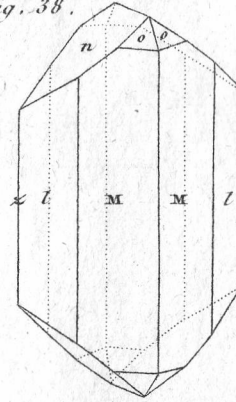


Fig. 39.

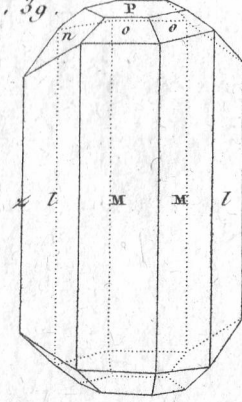


Fig. 40. A

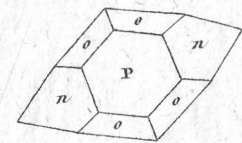
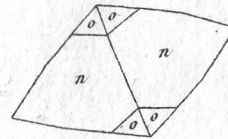
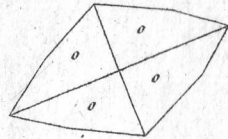
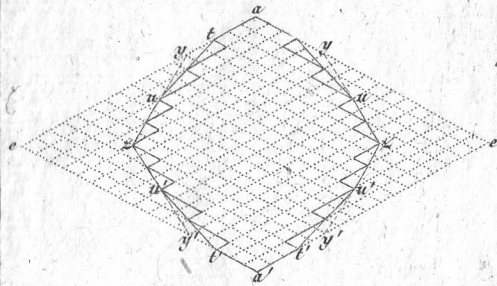


Fig. 40.

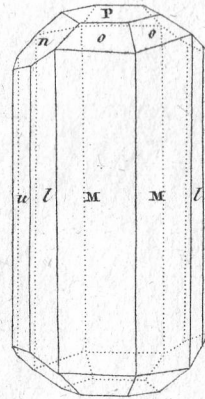


Fig. 41.

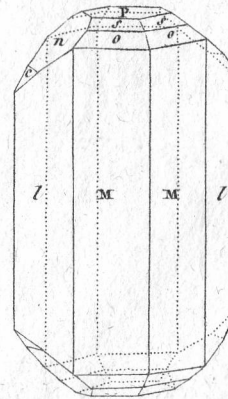


Fig. 42.

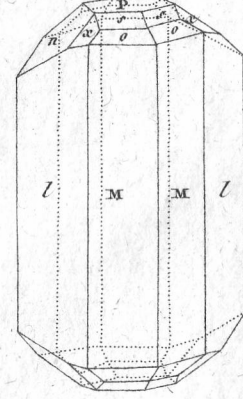
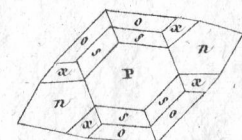
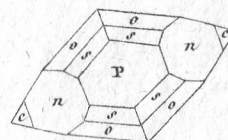
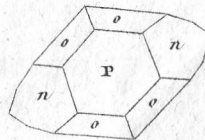
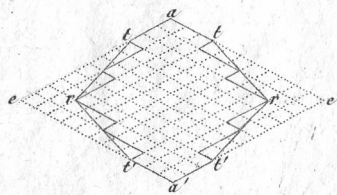


Fig. 37. A



EMERAUDE

Fig. 43.

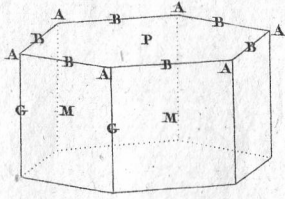


Fig. 44.

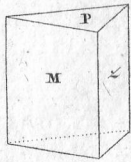


Fig. 48.

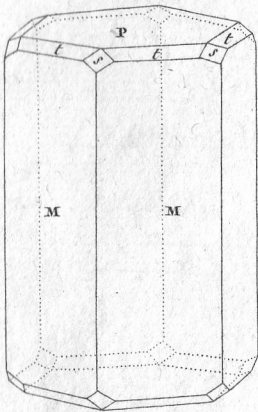


Fig. 45.

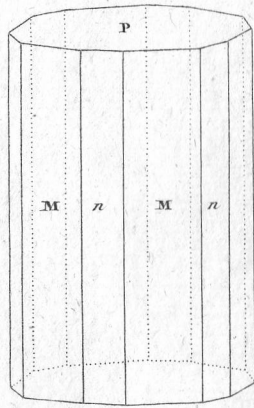


Fig. 49.

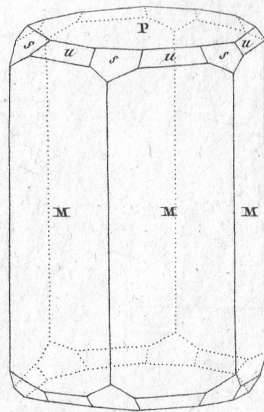


Fig. 46.

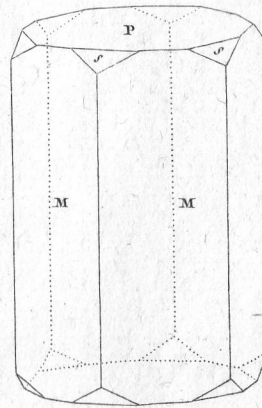


Fig. 50.

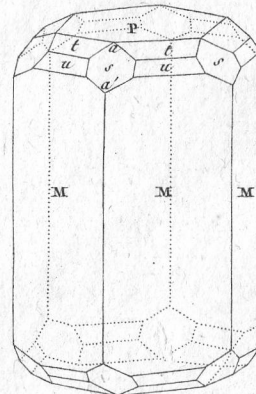
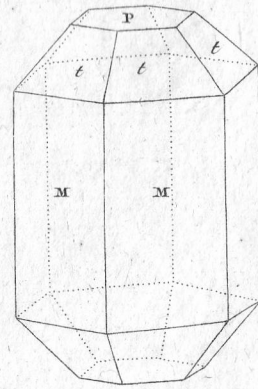


Fig. 47.



EUCLASE

Fig. 51.

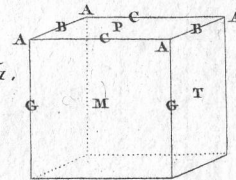
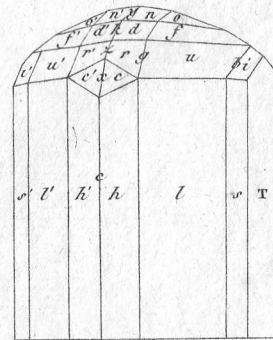


Fig. 52.



GRENAT

Fig. 53.

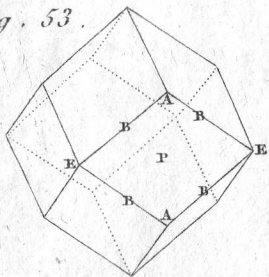


Fig. 54.

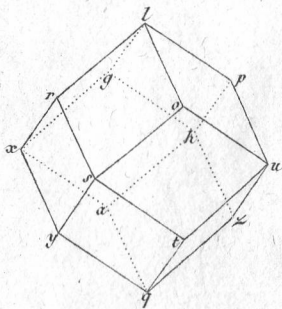


Fig. 55.

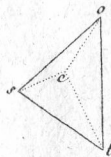


Fig. 56.

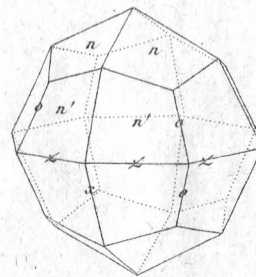


Fig. 57.

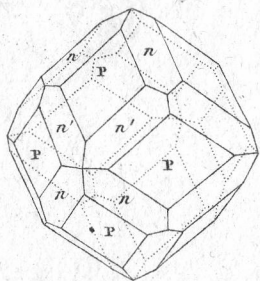


Fig. 58.

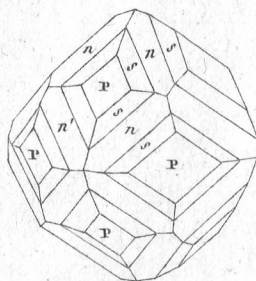


Fig. 59.

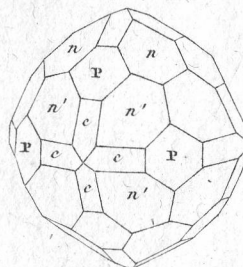
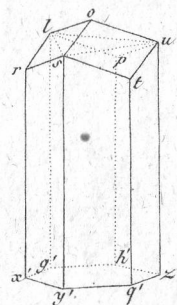


Fig. 60.



AMPHIGENE

Fig. 61.

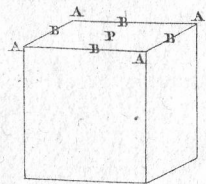


Fig. 62.

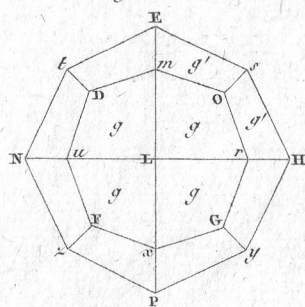
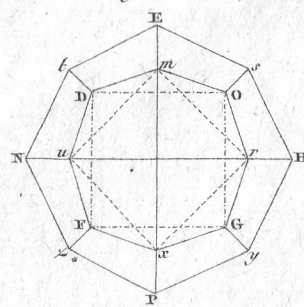


Fig. 63.



Suite de L'AMPHIGENE

Fig. 64.

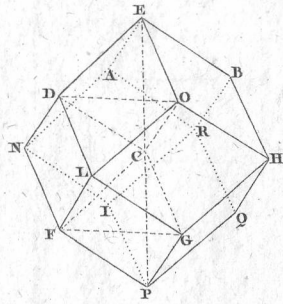


Fig. 65.

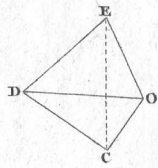


Fig. 66.

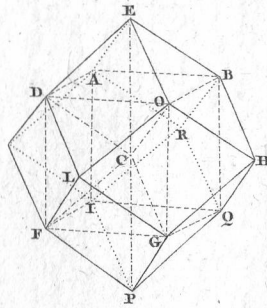


Fig. 67.

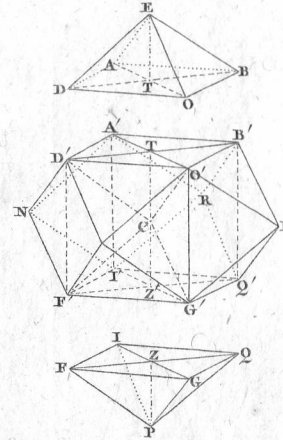
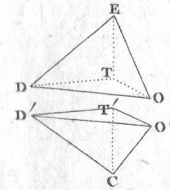


Fig. 68.



IDOCRASE

Fig. 69.

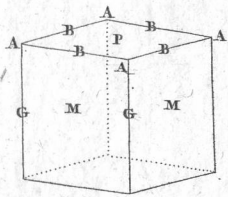


Fig. 70.

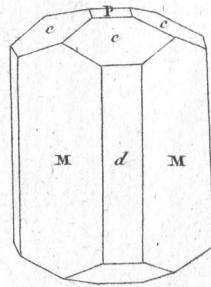


Fig. 72.

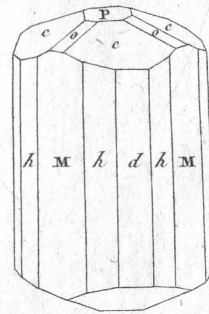


Fig. 74.

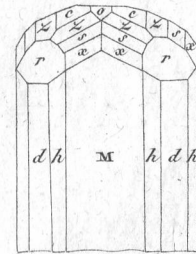


Fig. 71.

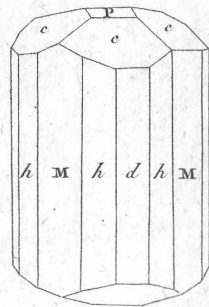
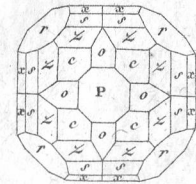
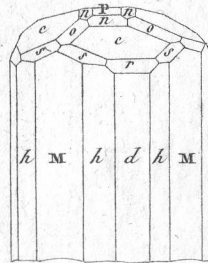


Fig. 73.



MEIONITE

FELD-SPATH

Fig. 75.

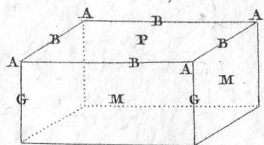


Fig. 76.

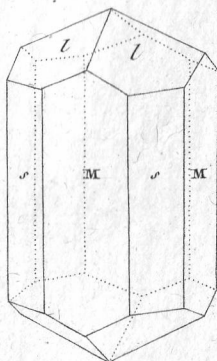


Fig. 77.

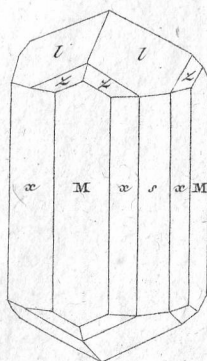


Fig. 78.

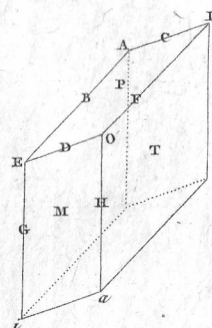


Fig. 79.

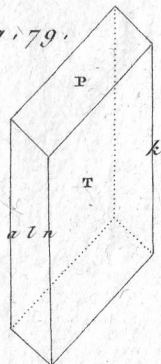


Fig. 82.

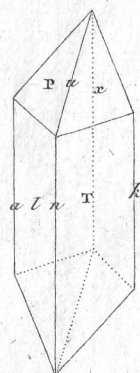


Fig. 83.

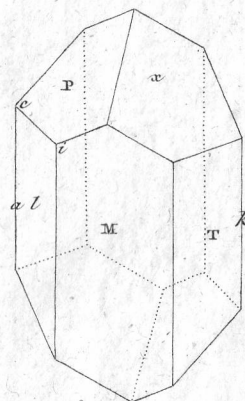


Fig. 80.

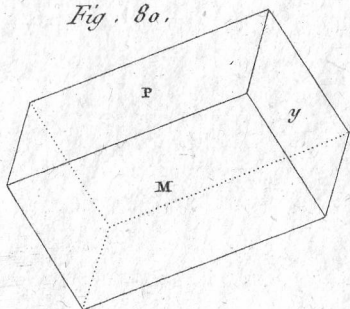
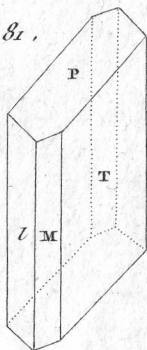


Fig. 81.



Suite du FELD-SPATH.

Fig. 84.

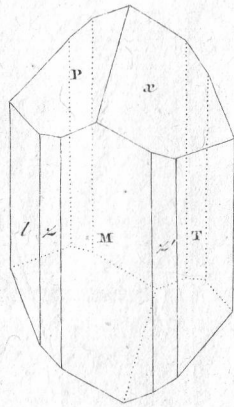


Fig. 85.

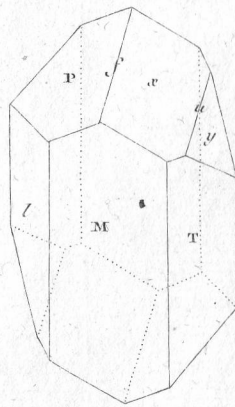


Fig. 86.

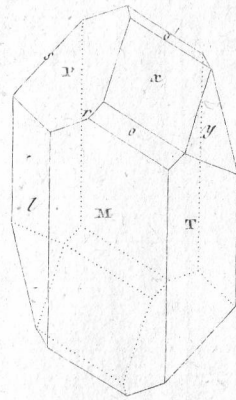


Fig. 87.

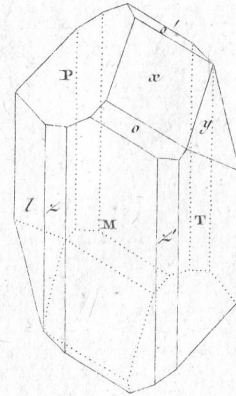


Fig. 88.

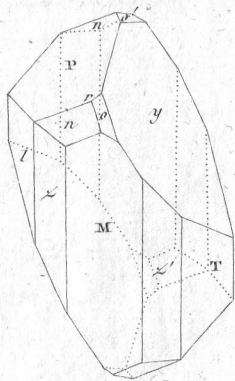


Fig. 89.

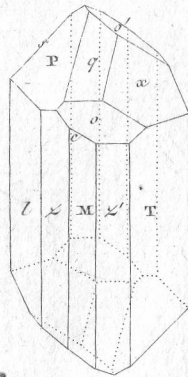


Fig. 90.

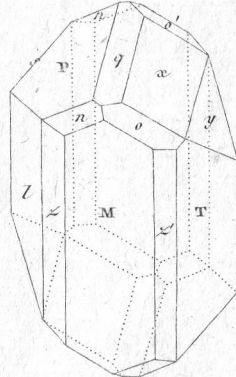


Fig. 91.

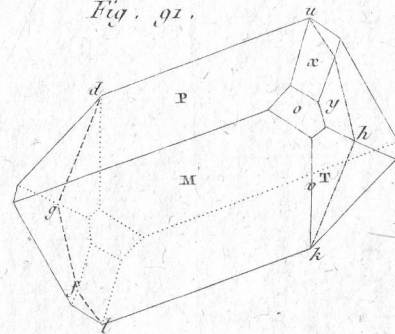
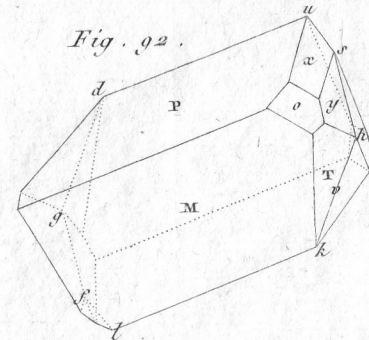


Fig. 92.



Suite du *FELD-SPATH*

Fig. 93.

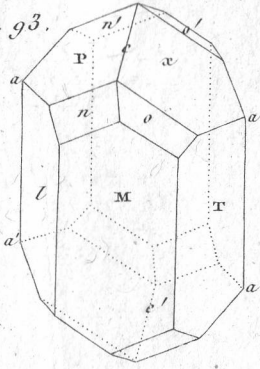


Fig. 94.

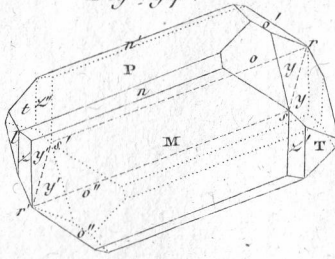
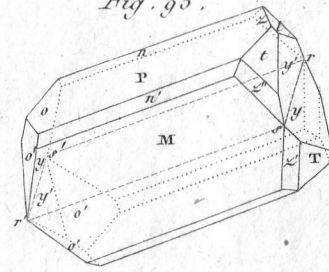


Fig. 95.



CORINDON

Fig. 96.

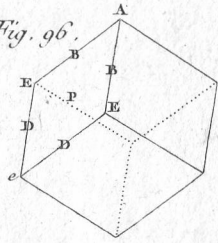


Fig. 97.

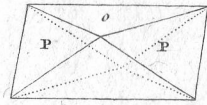


Fig. 98.

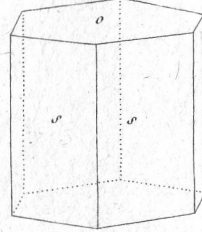


Fig. 99.

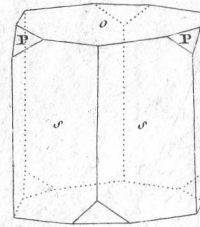
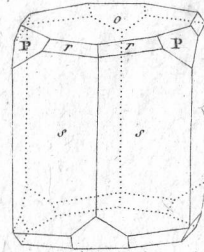


Fig. 100.



PLEONASTE

Fig. 101.

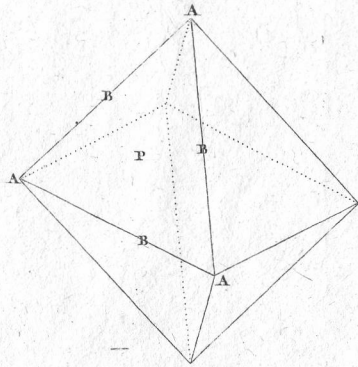


Fig. 102.

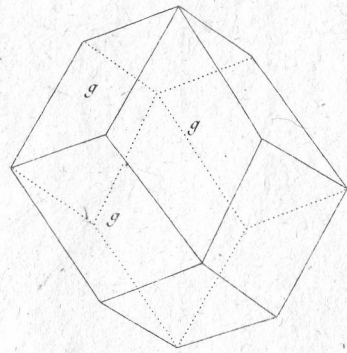


Fig. 103.

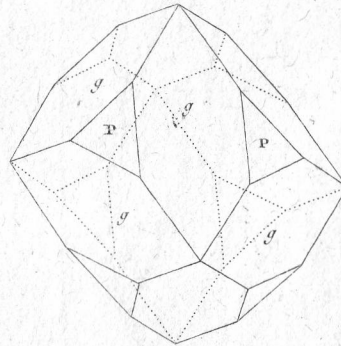
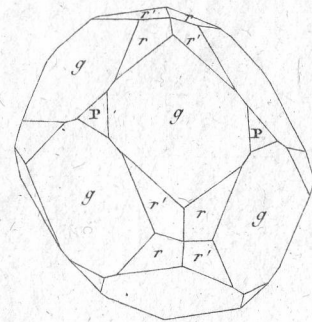


Fig. 104.



AXINITE

Fig. 105.

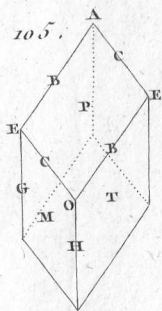


Fig. 106.

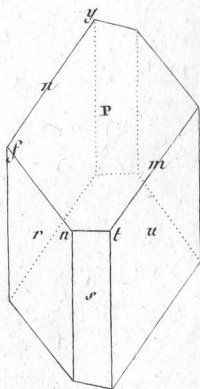


Fig. 107.

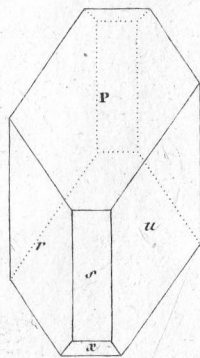


Fig. 108.

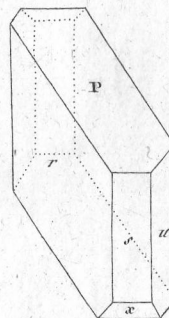


Fig. 109.

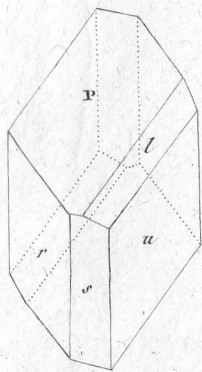


Fig. 110.

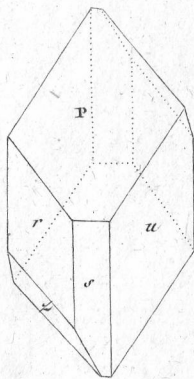


Fig. 111.

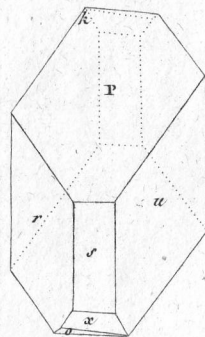
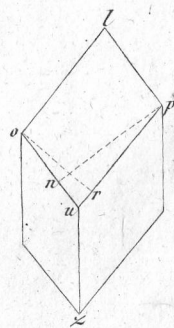


Fig. 112.



TOURMALINE

Fig. 113.

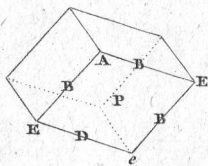


Fig. 114.

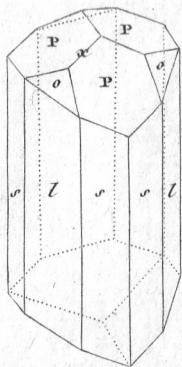


Fig. 115.

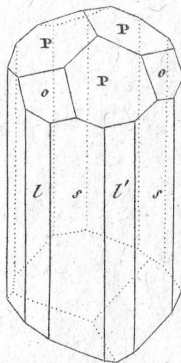


Fig. 116.

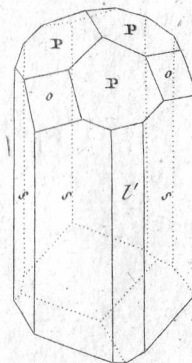


Fig. 117.

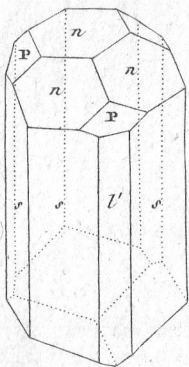


Fig. 118.

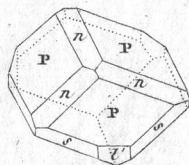


Fig. 119.

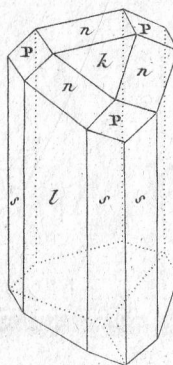


Fig. 120.

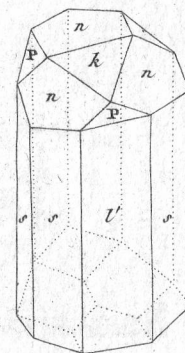


Fig. 121.

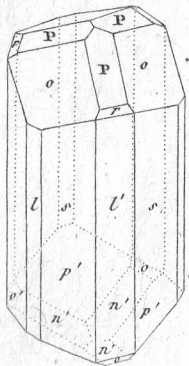


Fig. 122.

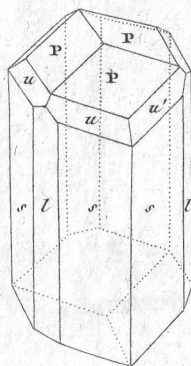


Fig. 123.

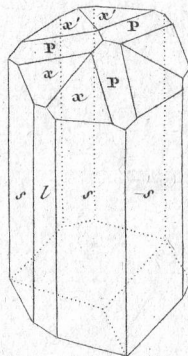
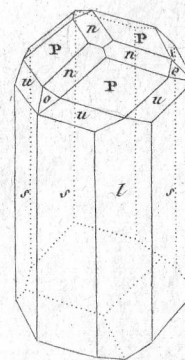


Fig. 124.



suite de la TOURMALINE

Fig. 125.

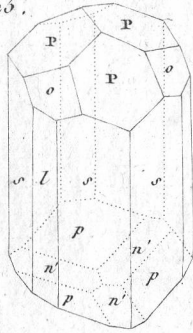


Fig. 126.

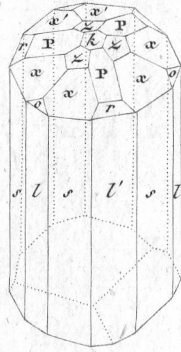


Fig. 127.

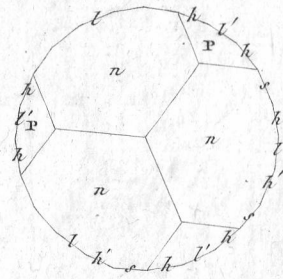


Fig. 128.

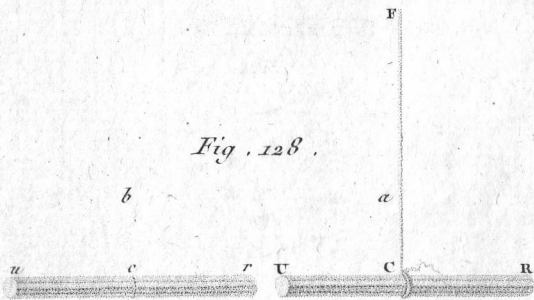


Fig. 129.

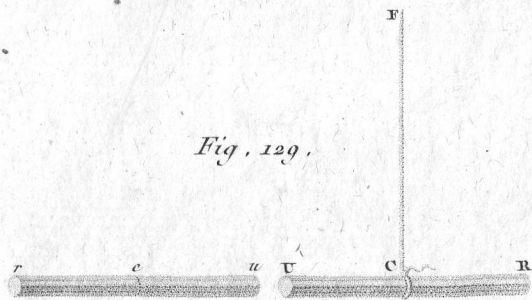


Fig. 130.

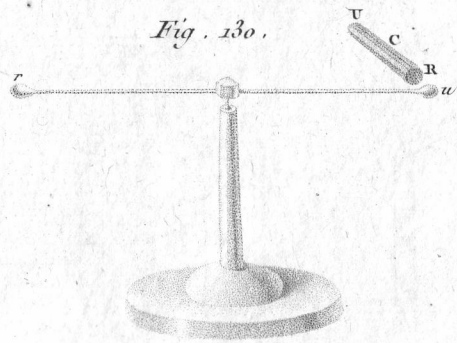


Fig. 131.



AMPHIBOLE

Fig. 132.

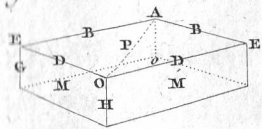


Fig. 133.

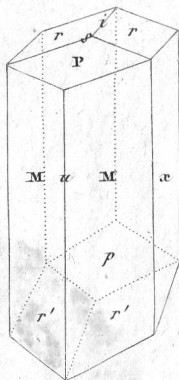


Fig. 134.

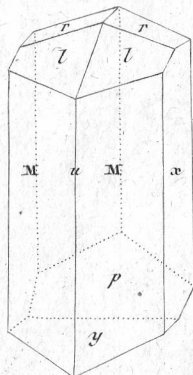


Fig. 135.

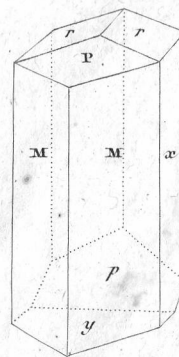


Fig. 136.

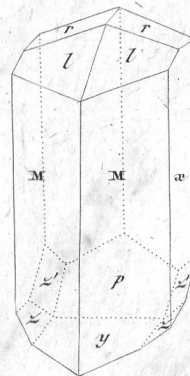
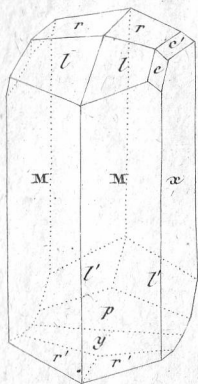


Fig. 137.



PYROXENE

Fig. 138.

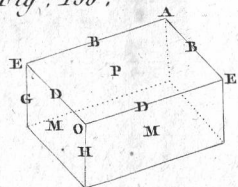


Fig. 139.

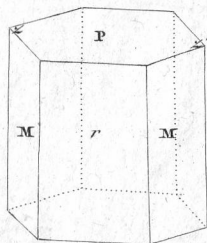


Fig. 140.

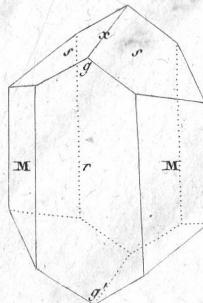


Fig. 141.

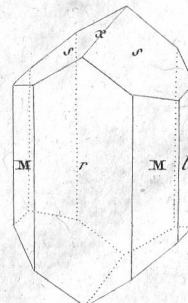


Fig. 142.

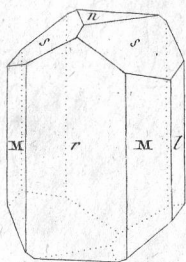


Fig. 143.

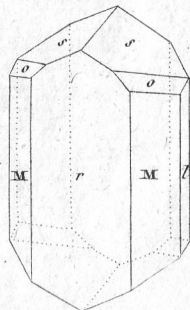


Fig. 144.

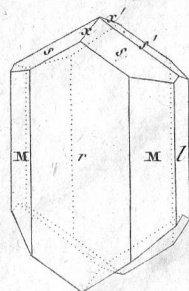
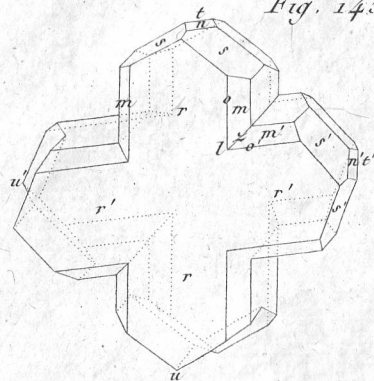


Fig. 145.



STAUROTIDE

Fig. 146.



Fig. 147.

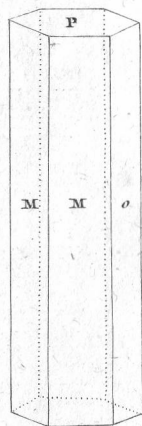


Fig. 148.

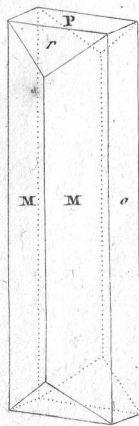


Fig. 149.

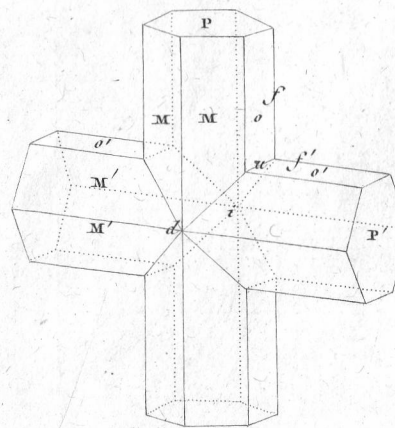


Fig. 150.

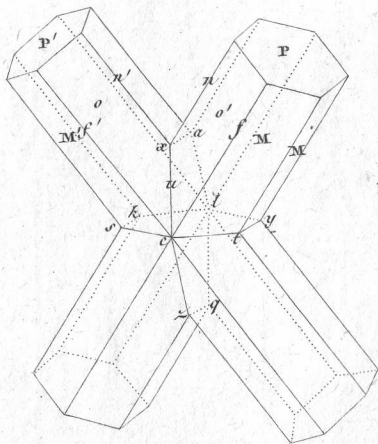


Fig. 152.

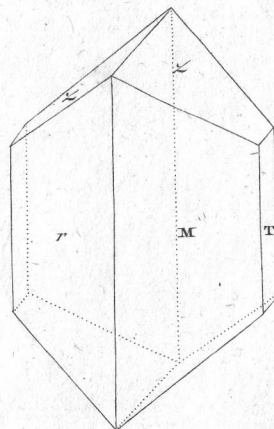
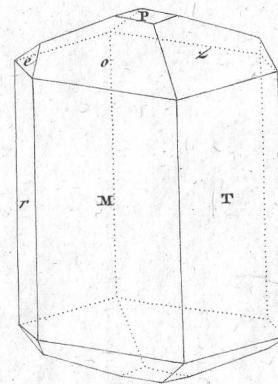
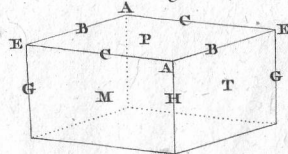


Fig. 153.



EPIDOTE

Fig. 151.



Suite de L'ÉPIDOTE

Fig. 154.

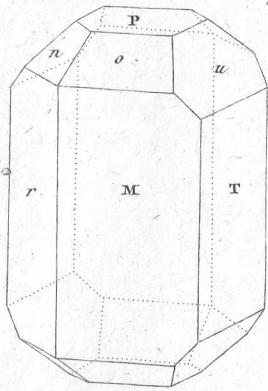


Fig. 155.

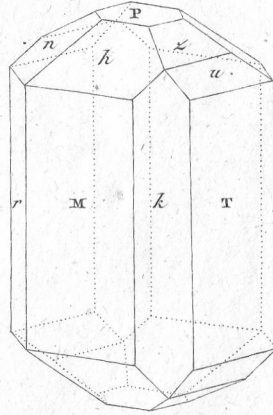


Fig. 156.

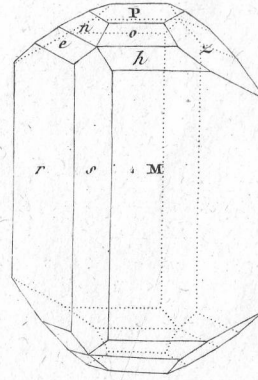


Fig. 157.

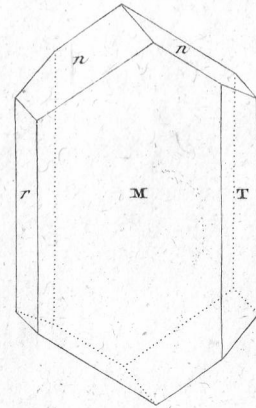


Fig. 158.

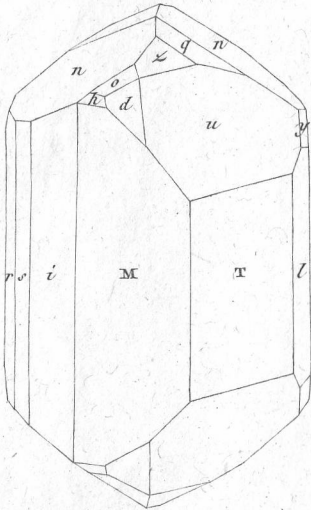
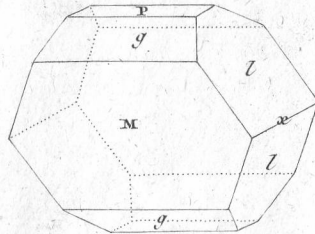


Fig. 159.



SPHENE

Fig. 160.

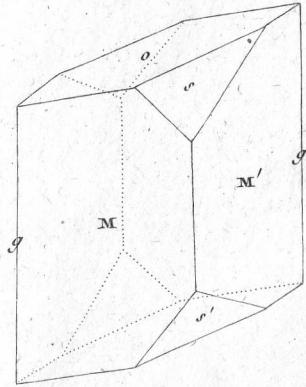
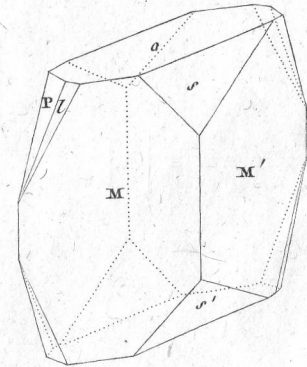


Fig. 161.



Suite du SPHÈRE

Fig. 162.

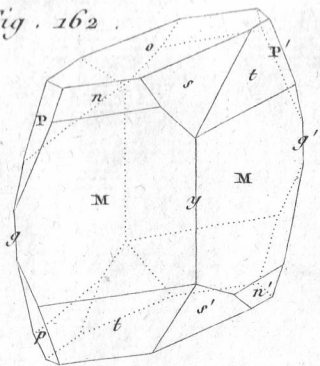


Fig. 163.

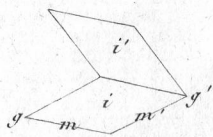


Fig. 164.

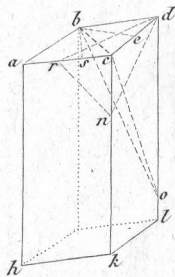
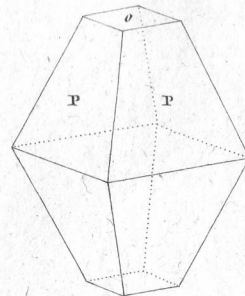


Fig. 168.



WERNERITE

Fig. 165.

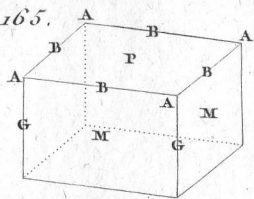
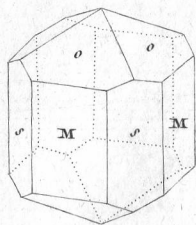


Fig. 166.



ANATASE

Fig. 167.

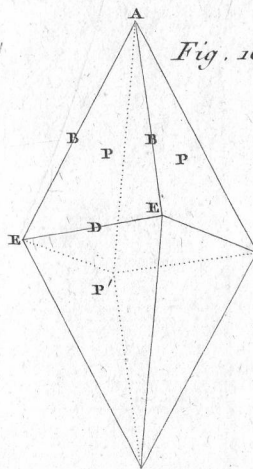


Fig. 172.

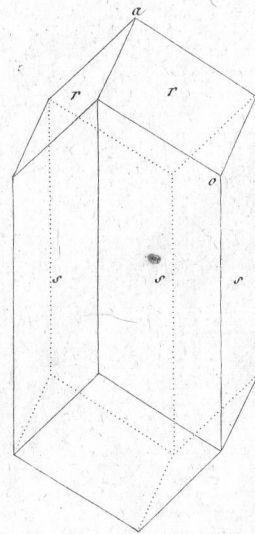


Fig. 169.

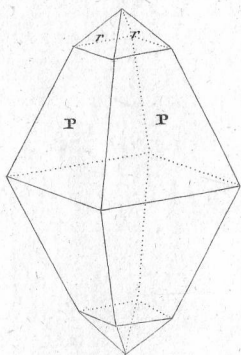
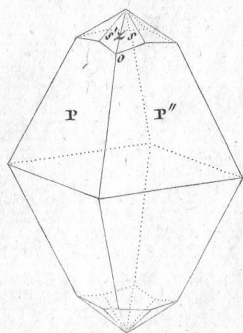


Fig. 170.



DIOPTASE

Fig. 171.



MESOTYPE

Fig. 173.

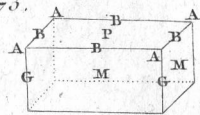


Fig. 174.

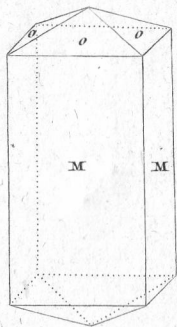


Fig. 175.

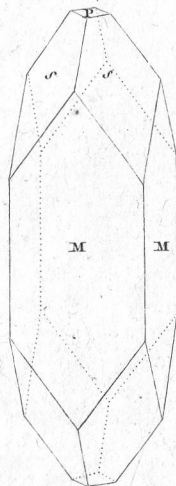
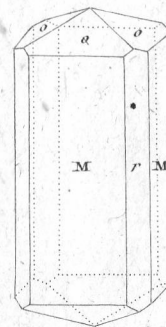


Fig. 176.



STILBITE

Fig. 177.

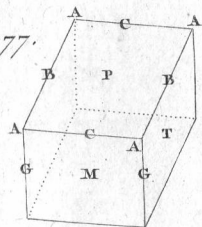


Fig. 179.

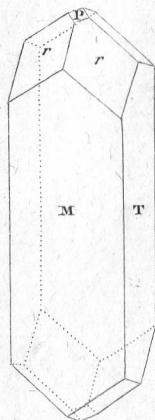


Fig. 180.

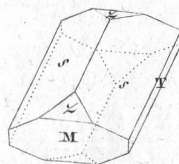


Fig. 181.

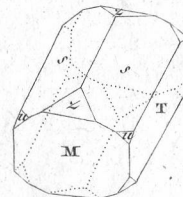
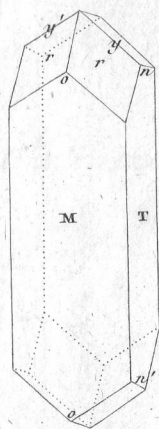


Fig. 178.



PREHNITE

Fig. 182.

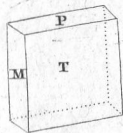


Fig. 183.

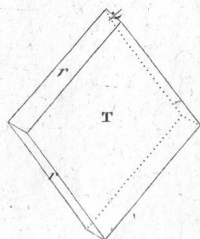


Fig. 184.

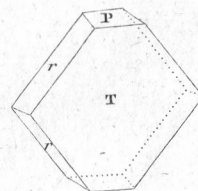
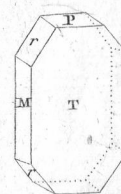


Fig. 185.



CHLORASIE

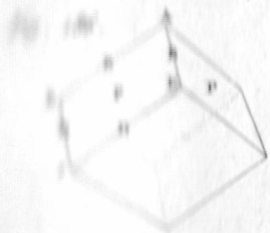


Fig. 187.

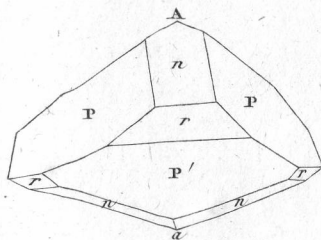
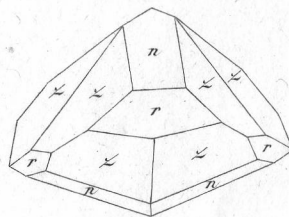


Fig. 188.



ANALCIME

Fig. 189.

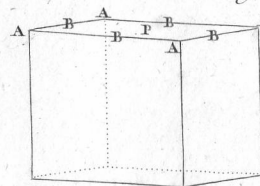


Fig. 190.

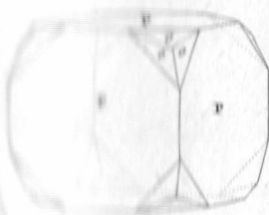
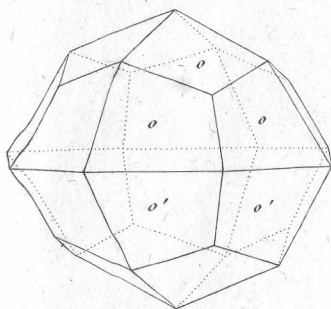


Fig. 191.



NEPHELINE

Fig. 192.

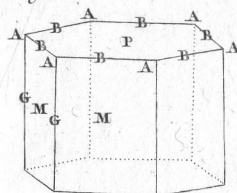


Fig. 193.

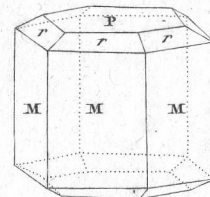


Fig. 195.

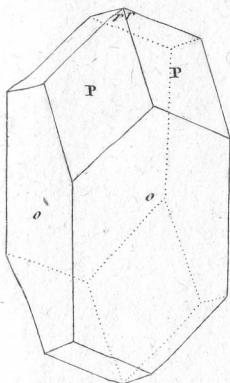


Fig. 196.

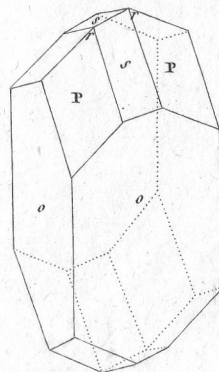
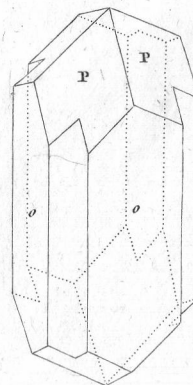


Fig. 197.



HAMMOTOME

Fig. 194.



PERIDOT

Fig. 198.

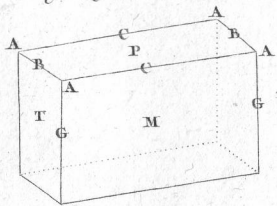


Fig. 199.

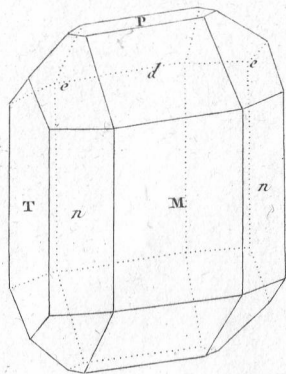


Fig. 200.

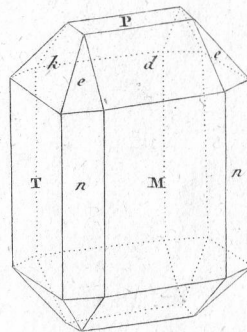


Fig. 201.

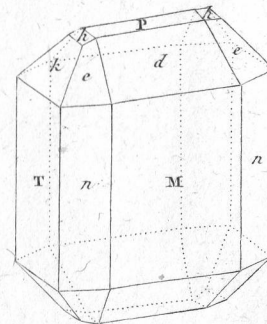


Fig. 202.

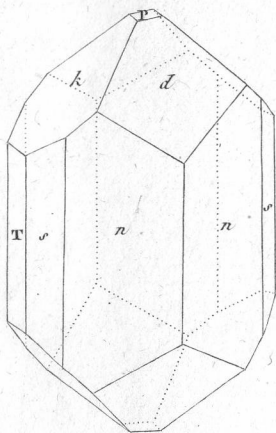


Fig. 203.

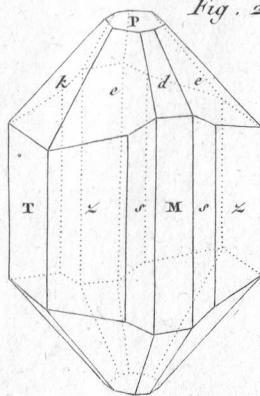
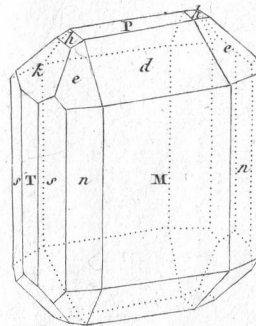


Fig. 204.



MICA

Fig. 205.

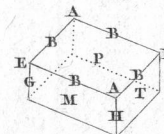


Fig. 206.

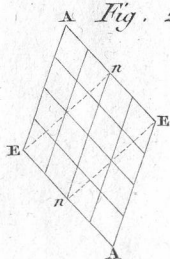


Fig. 207.

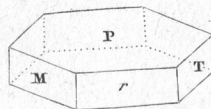


Fig. 208.

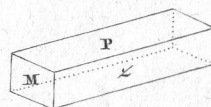
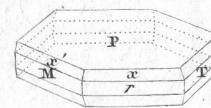


Fig. 209.



DISTHENE

Fig. 210.

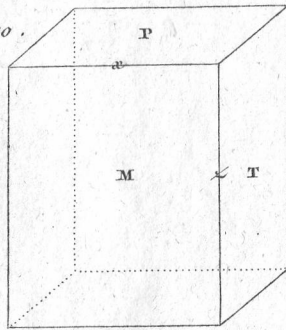
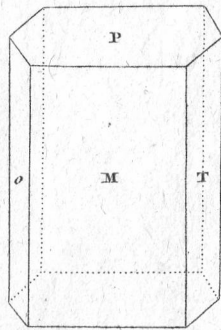


Fig. 211.



GRAMMATITE

Fig. 212.

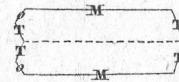


Fig. 213.

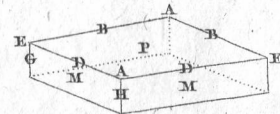


Fig. 214.

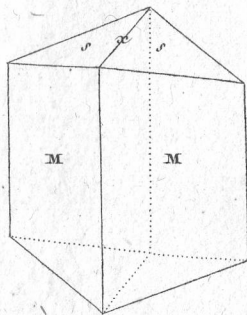


Fig. 215.

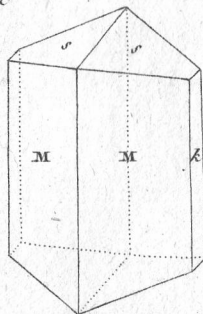
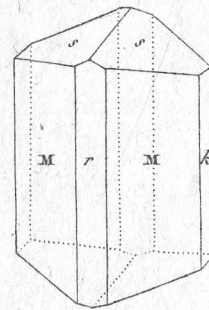
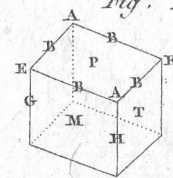


Fig. 216.



TALC

Fig. 217.



MACLE

Fig. 218.

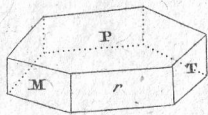


Fig. 219.

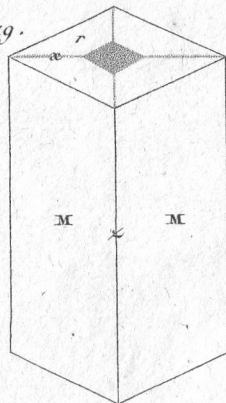


Fig. 220.

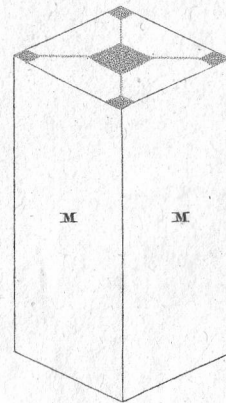
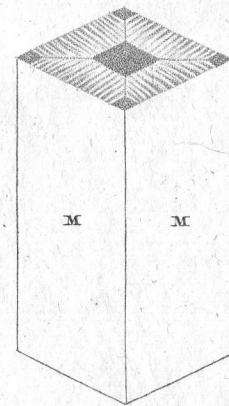


Fig. 221.



SOUFRE

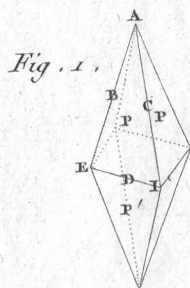


Fig. 2.

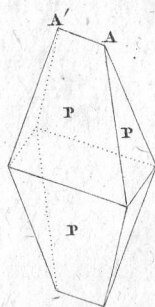


Fig. 3.

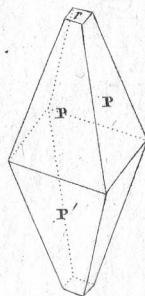


Fig. 4.

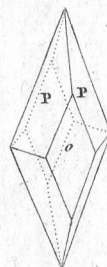


Fig. 5.

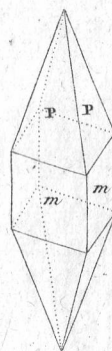


Fig. 6.

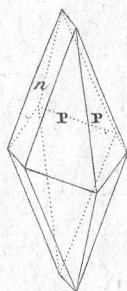


Fig. 7.

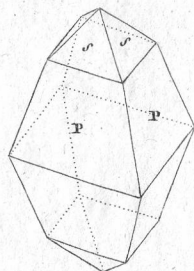


Fig. 8.

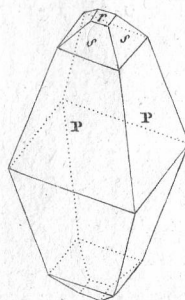
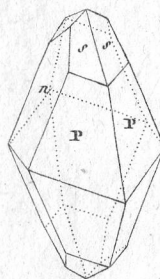


Fig. 9.



DIAMANT

Fig. 10.

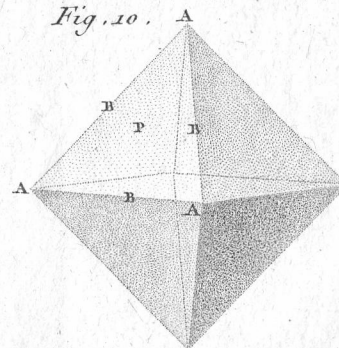
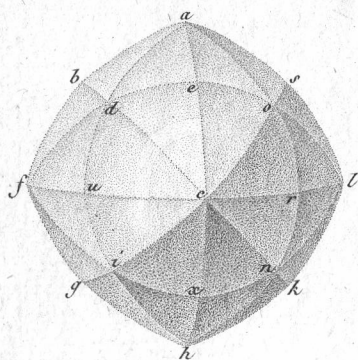


Fig. 11.



MELLITE

Fig. 12.

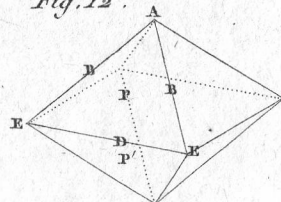


Fig. 13.

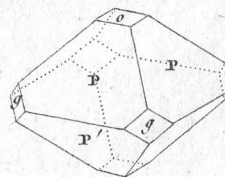
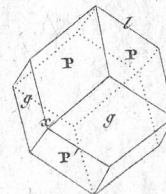


Fig. 14.



OR NATIF, ARGENT NATIF, ARGENT SULFURÉ
 CUIVRE NATIF ET COBALT ARSENICAL

Fig. 1.

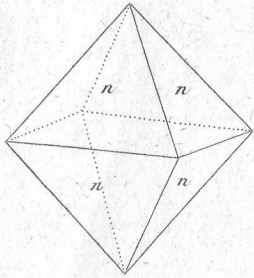


Fig. 5.

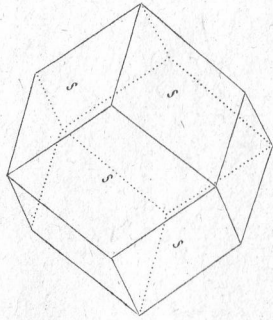


Fig. 3.

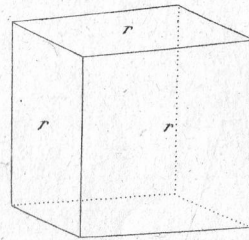


Fig. 4.

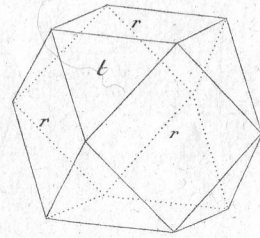


Fig. 2.

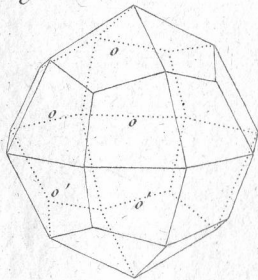


Fig. 6.

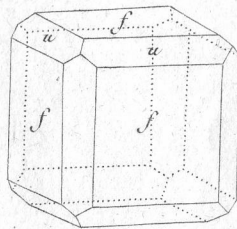
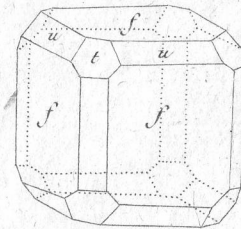


Fig. 7.



ARGENT ANTIMONIE' SULFURE'

Fig. 8.

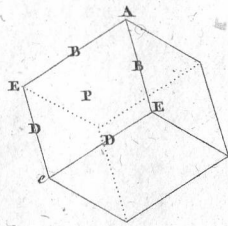


Fig. 9.

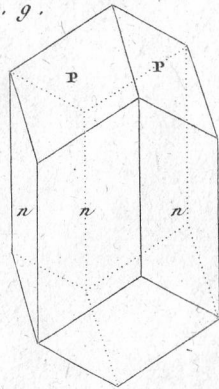


Fig. 10.

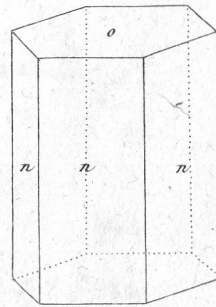


Fig. 11.

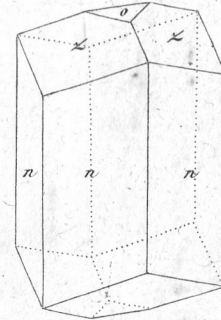


Fig. 12.

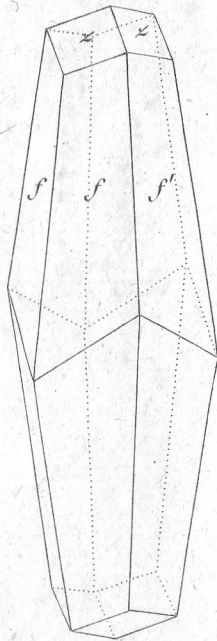


Fig. 13.

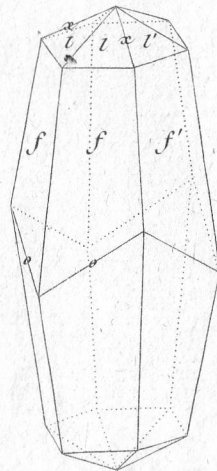


Fig. 14.

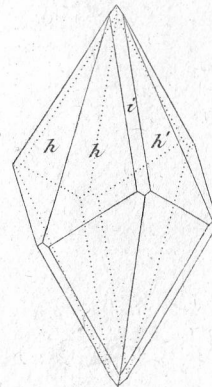
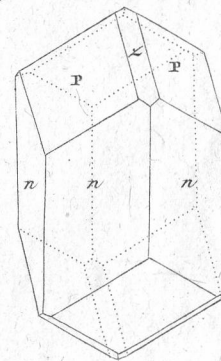


Fig. 15.



Suite de L'ARGENT ANTIMONIE' SULFURE'

Fig. 16.

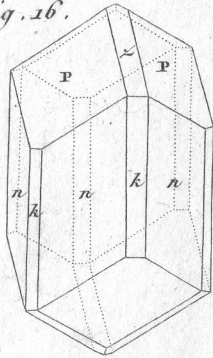


Fig. 17.

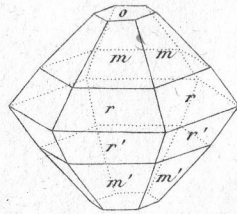


Fig. 18.

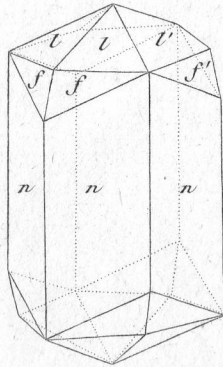


Fig. 19.

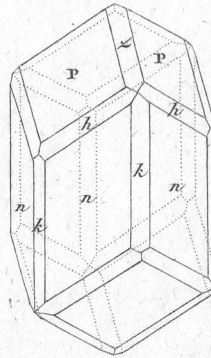


Fig. 20.

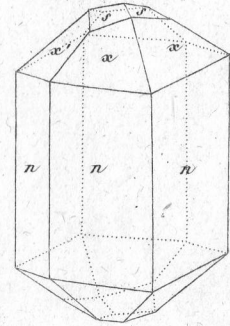


Fig. 21.

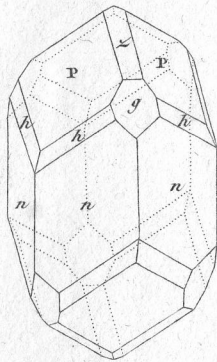
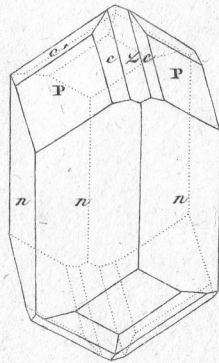


Fig. 22.



MERCURE ARGENTAL

Fig. 23.

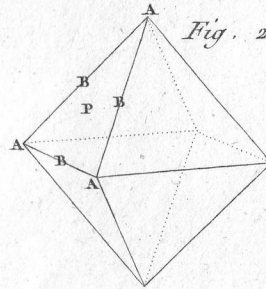


Fig. 24.

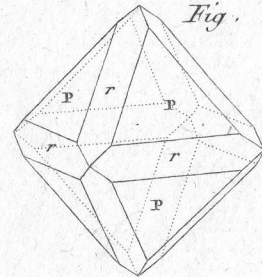


Fig. 25.

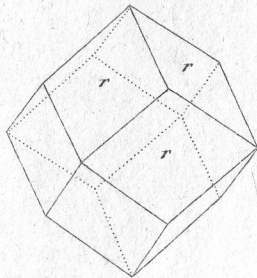
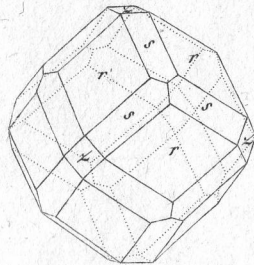


Fig. 26.



MERCURE SULFURE'

Fig. 27.

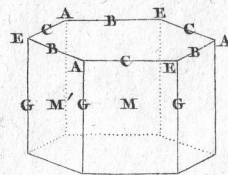
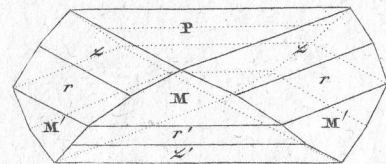


Fig. 28.



MERCURE MURIATÉ. PLOMB SULFURÉ

Fig. 29.

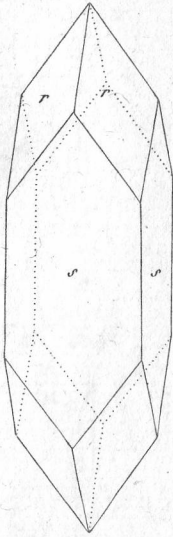


Fig. 30.

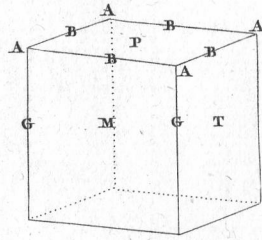


Fig. 31.

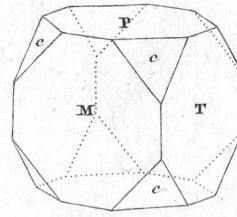


Fig. 32.

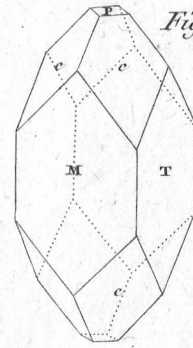


Fig. 35.

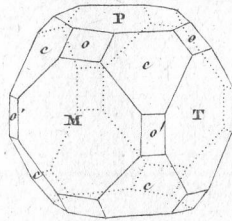


Fig. 33.

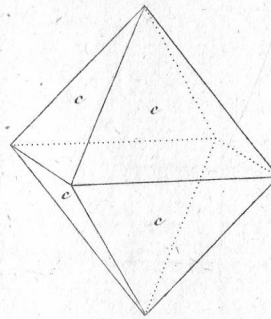


Fig. 34.

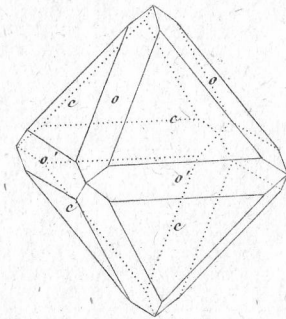


Fig. 37.

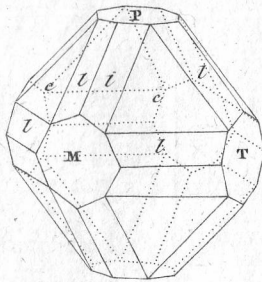


Fig. 38.

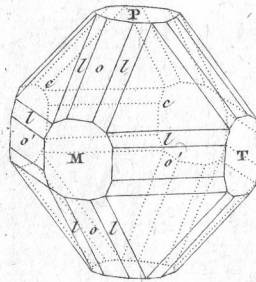
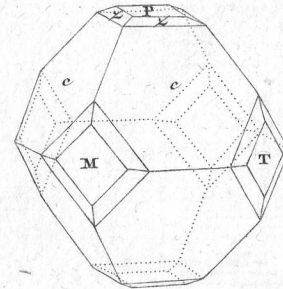


Fig. 36.



PLOMB CHROMATÉ

Fig. 39.

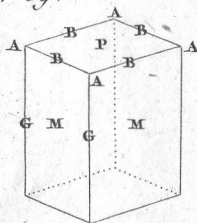


Fig. 40.

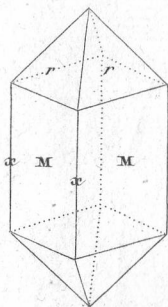


Fig. 41.

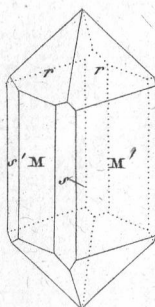


Fig. 42.

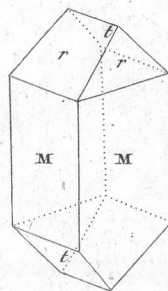
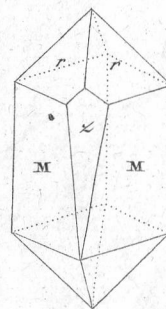


Fig. 43.



PLOMB CARBONATE

Fig. 44.

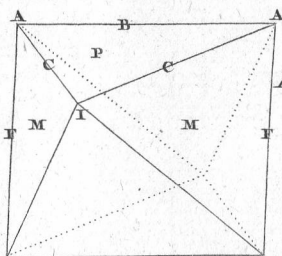
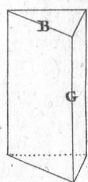


Fig. 45.

Fig. 46.

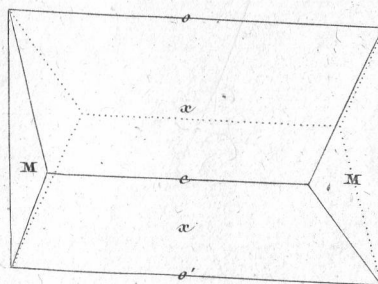


Fig. 47.

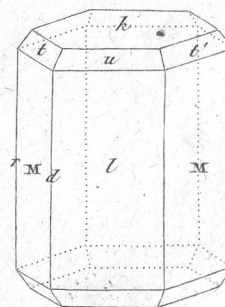


Fig. 48.

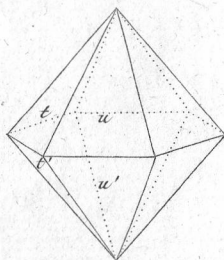


Fig. 49.

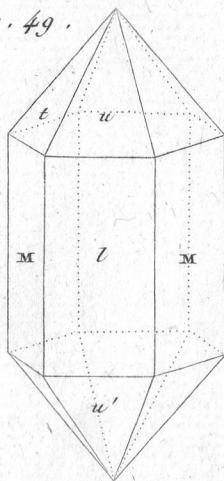


Fig. 50.

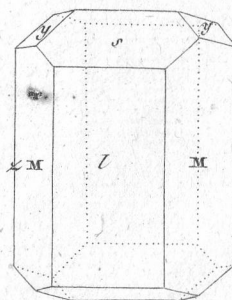
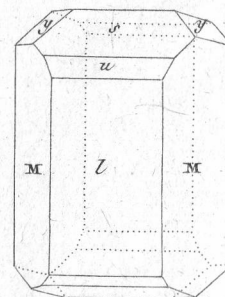


Fig. 51.



Suite du **PLOMB CARBONATÉ**

Fig. 52.

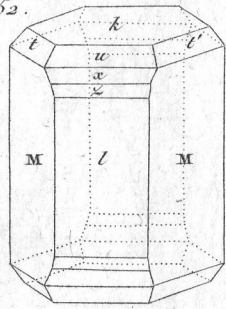


Fig. 53

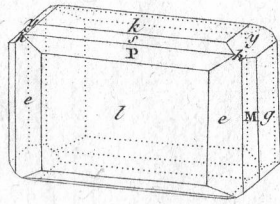


Fig. 54

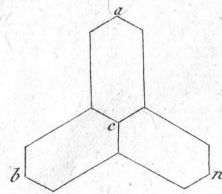
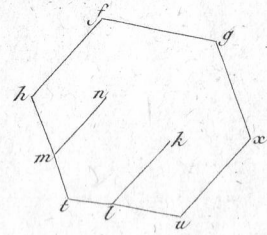


Fig. 55.



PLOMB PHOSPHATÉ

Fig. 56.

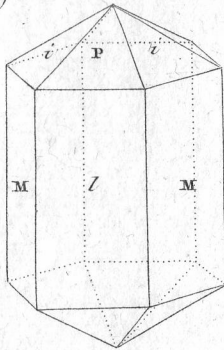


Fig. 57.

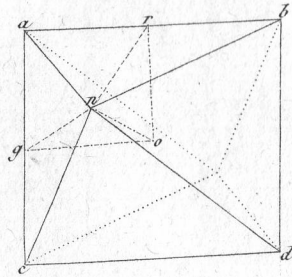


Fig. 58.

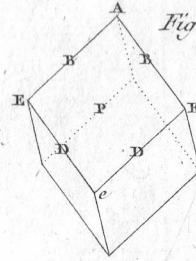


Fig. 59.

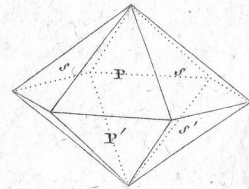


Fig. 60.

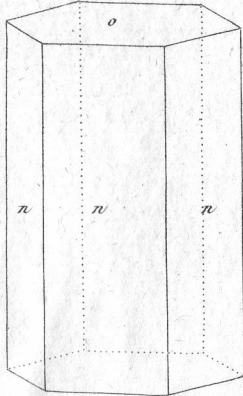


Fig. 61.

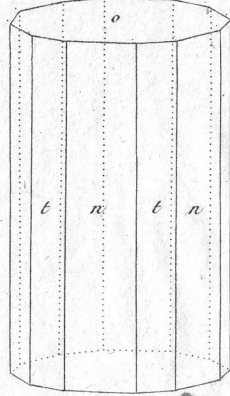


Fig. 62.

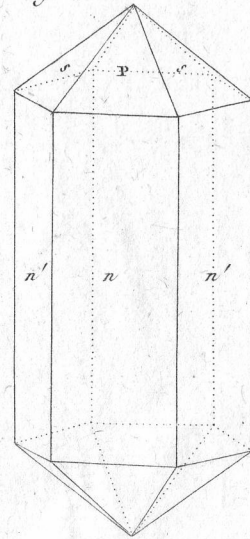
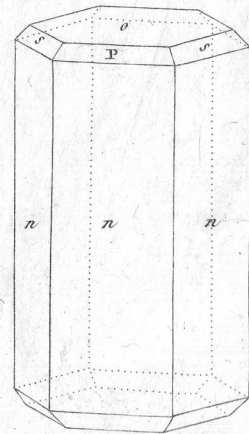


Fig. 63.



PLOMB MOLYBDATE

Fig. 64.

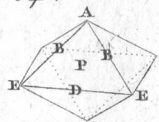


Fig. 65.

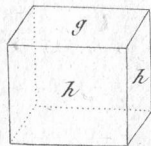


Fig. 66.

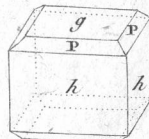


Fig. 67.

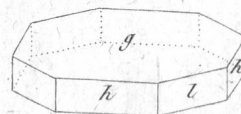


Fig. 68.

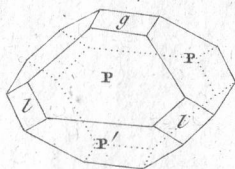


Fig. 69.

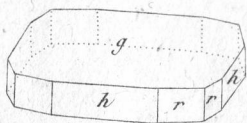
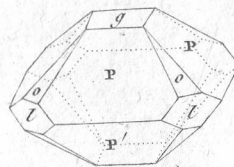


Fig. 70.



PLOMB SULFATE

Fig. 71.

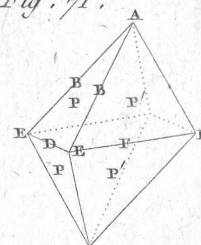


Fig. 72.

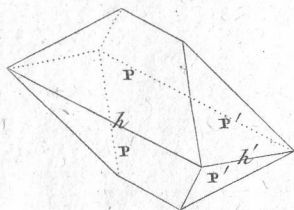


Fig. 74.

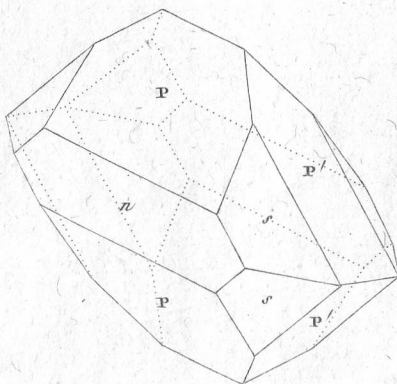


Fig. 75.

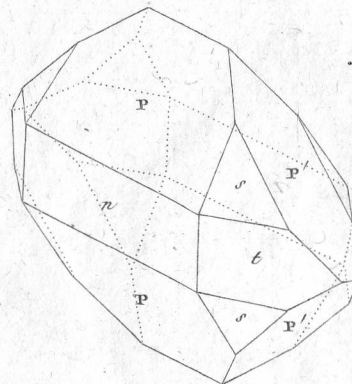
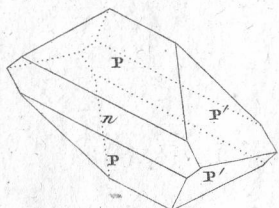


Fig. 73.



Suite du PLOMB SULFATE

CUIVRE GRIS ET CUIVRE PYRITEUX

Fig. 76.

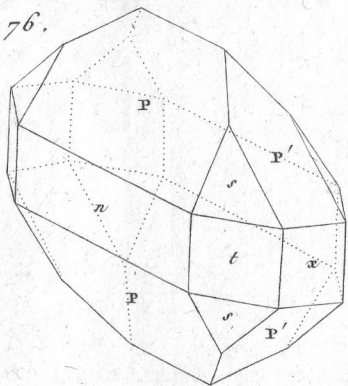


Fig. 77.

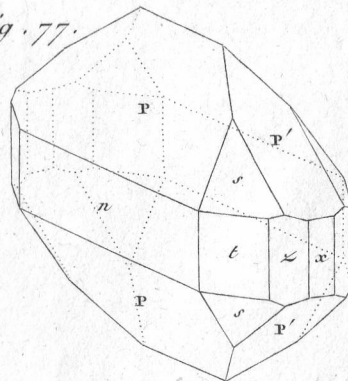


Fig. 78.

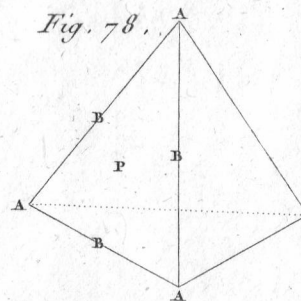


Fig. 79.

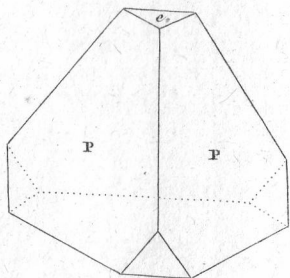


Fig. 80.

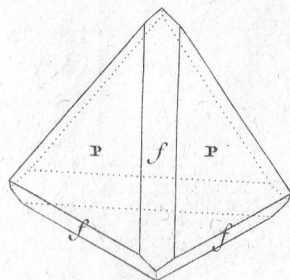


Fig. 81.

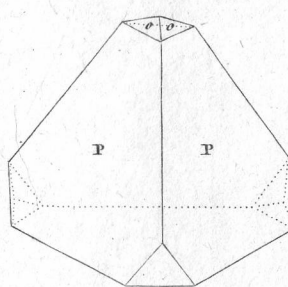


Fig. 82.

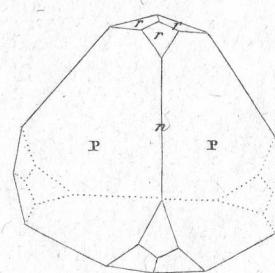


Fig. 83.

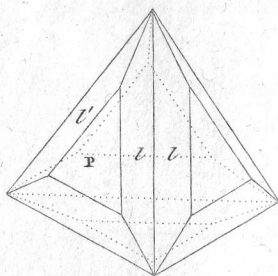


Fig. 84.

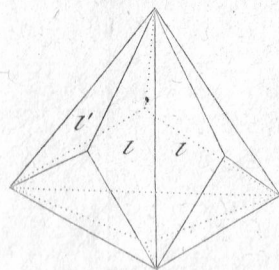


Fig. 85.

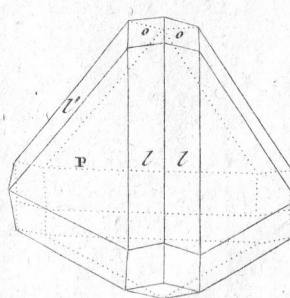
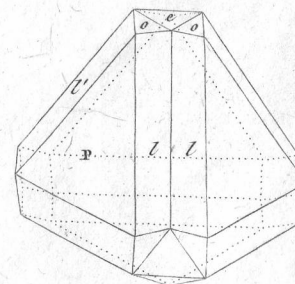


Fig. 86.



Suite du CUIVRE GRIS

Fig. 87.

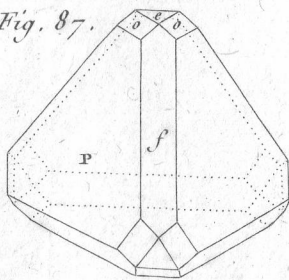


Fig. 88.

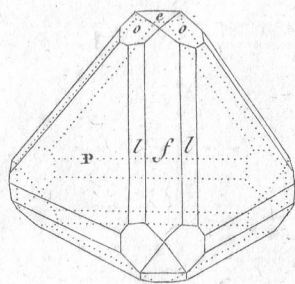


Fig. 89.

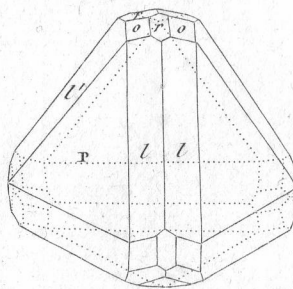
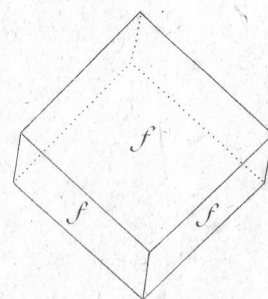


Fig. 90.



CUIVRE OXYDÉ ROUGE

Fig. 91.

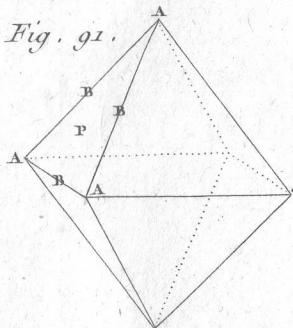


Fig. 92.

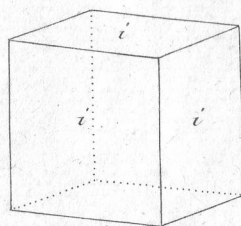


Fig. 93.

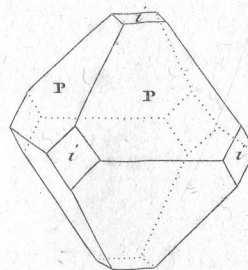
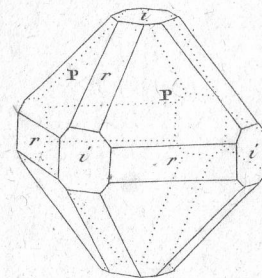


Fig. 94.



CUIVRE CARBONATÉ BLEU

Fig. 95.

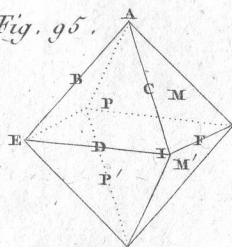


Fig. 96.

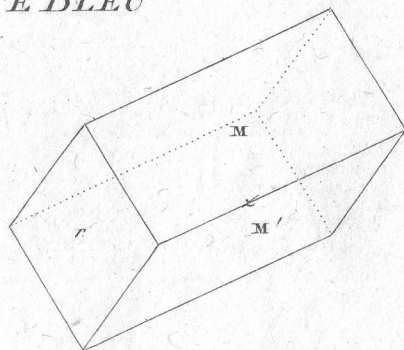
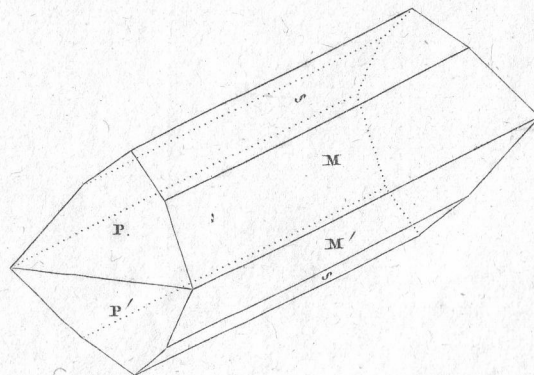


Fig. 97.



Suite du CUIVRE CARBONATÉ BLEU

Fig. 98.

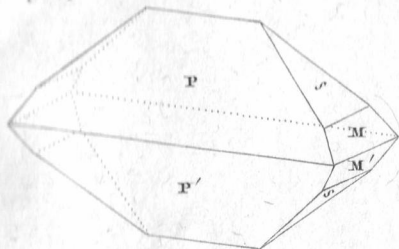


Fig. 99.

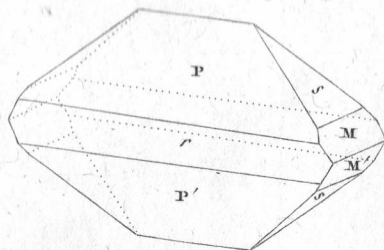


Fig. 100.

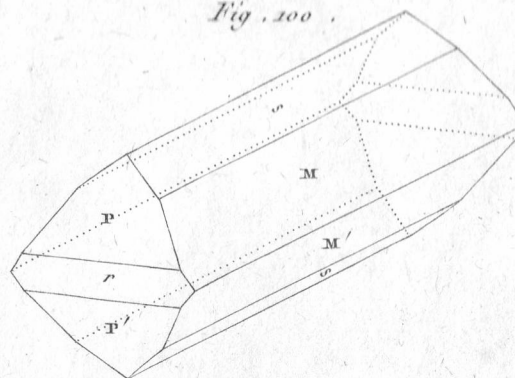
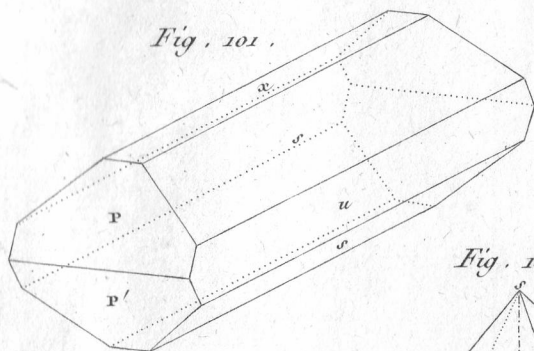


Fig. 101.



CUIVRE SULFATÉ

Fig. 103.

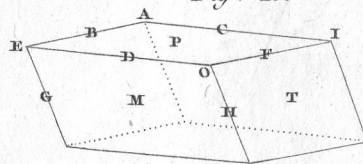


Fig. 104.

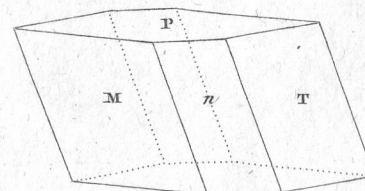


Fig. 102.

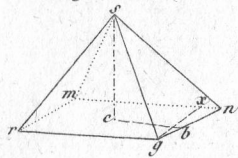


Fig. 105.

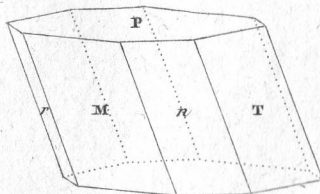


Fig. 106.

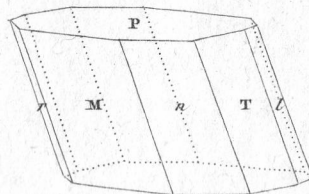
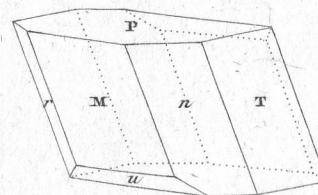


Fig. 107.



Suite du **CUIVRE SULFATE**

Fig. 108.

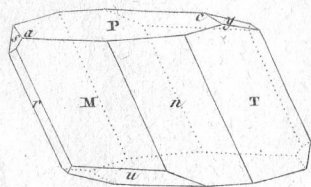


Fig. 109.

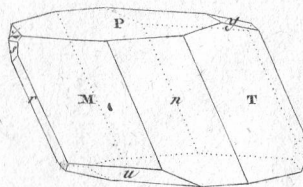


Fig. 110.

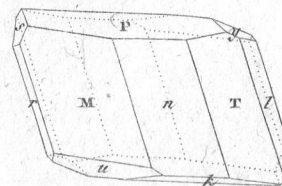


Fig. 111.

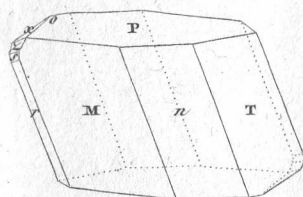


Fig. 112.

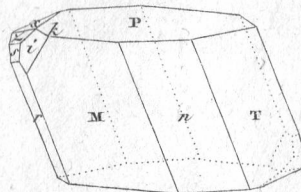


Fig. 113.

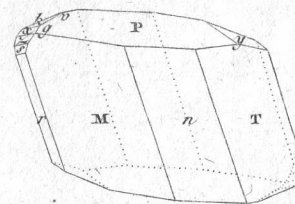
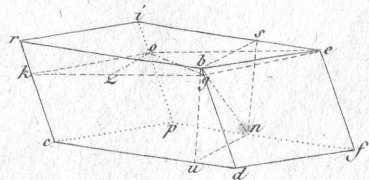


Fig. 114.



NICKEL

Fig. 115.

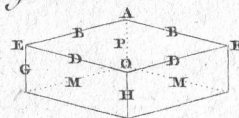
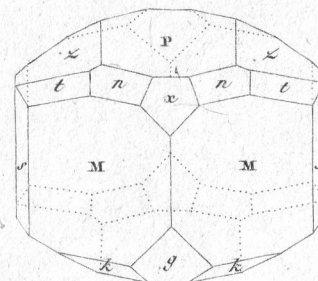


Fig. 116.



FER OXYDULÉ

Fig. 117.

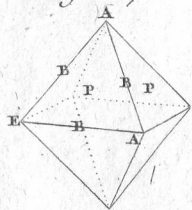


Fig. 118.

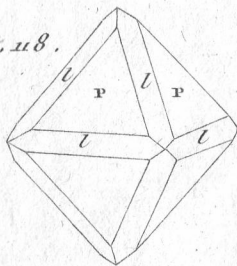


Fig. 119.

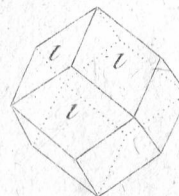
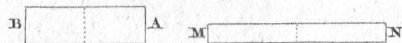


Fig. 120.



FER OLIGISTE

Fig. 122.

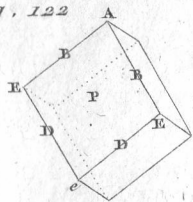


Fig. 121.

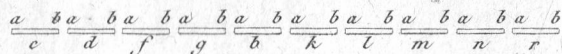


Fig. 123.

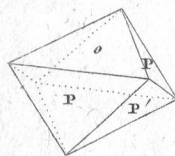


Fig. 124.

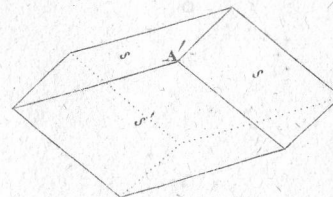


Fig. 125.

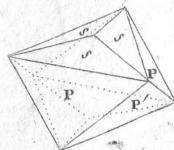


Fig. 126.

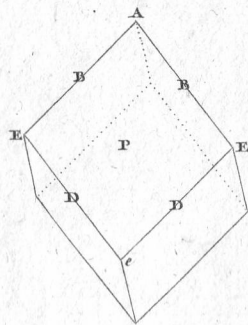
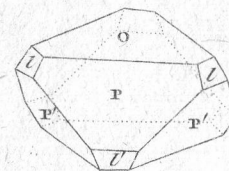


Fig. 127.



Suite du FER OLIGISTE

Fig. 128.

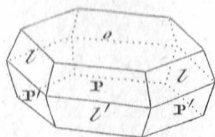


Fig. 129.

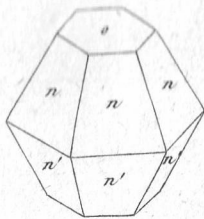


Fig. 130.

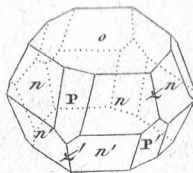


Fig. 131.

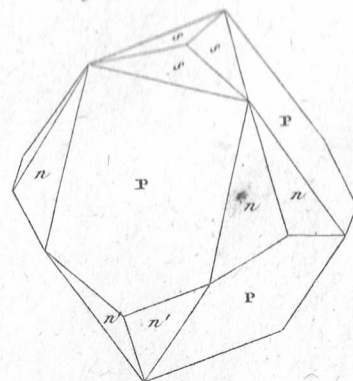


Fig. 132.

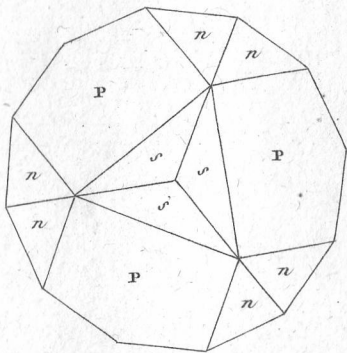


Fig. 133.

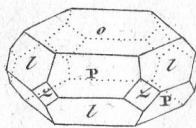
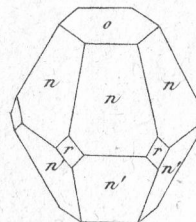


Fig. 134.



FER ARSENICAL

Fig. 135.

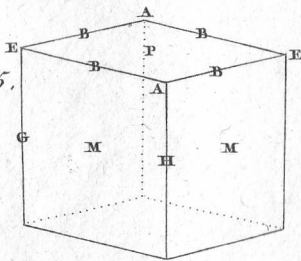


Fig. 136.

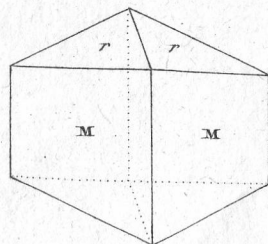
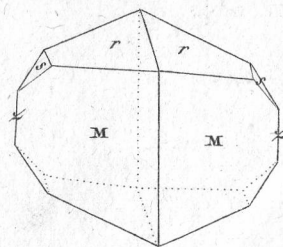


Fig. 137.



FER SULFURE

Fig. 138.

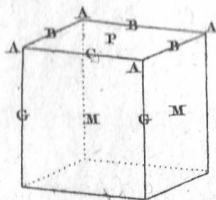


Fig. 139.

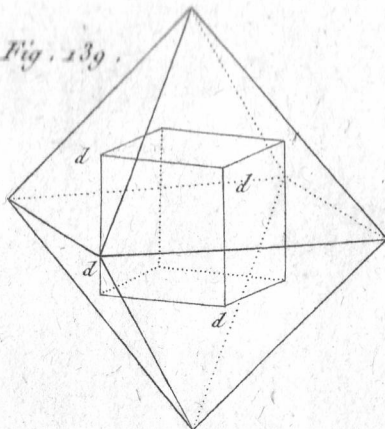


Fig. 140.

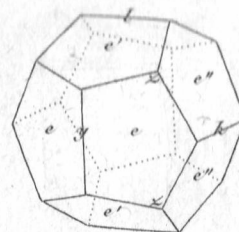


Fig. 141.

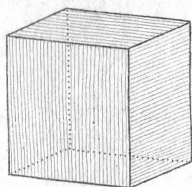


Fig. 142.

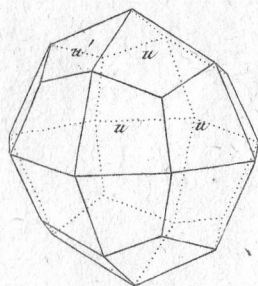


Fig. 143.

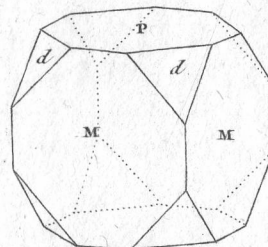


Fig. 144.

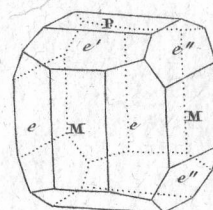


Fig. 145.

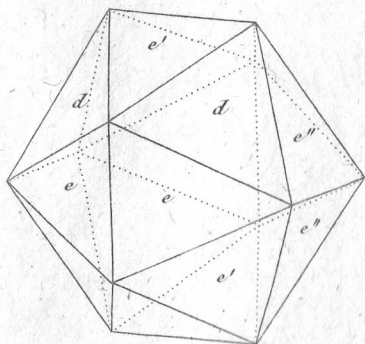


Fig. 146.

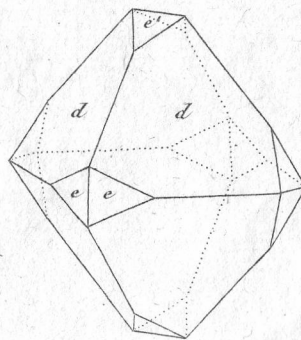
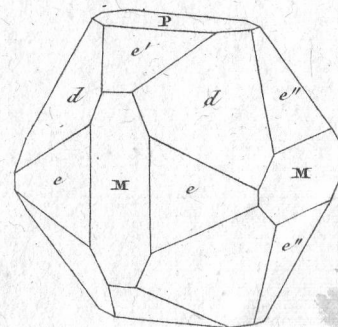


Fig. 147.



Suite du FER SULFURE'

Fig. 148.

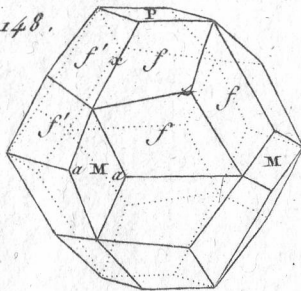


Fig. 149.

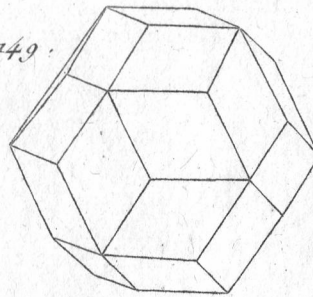


Fig. 150.

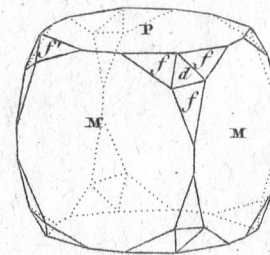


Fig. 151.

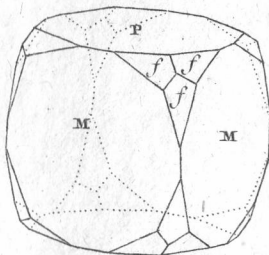


Fig. 152.

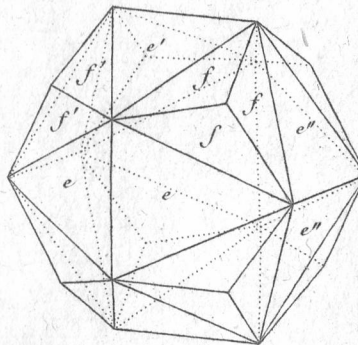


Fig. 153.

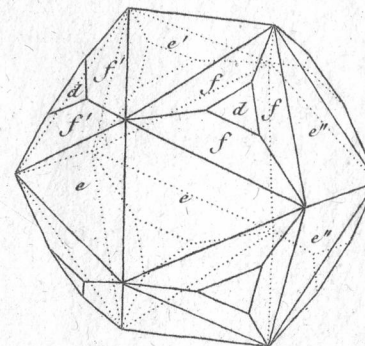


Fig. 154.

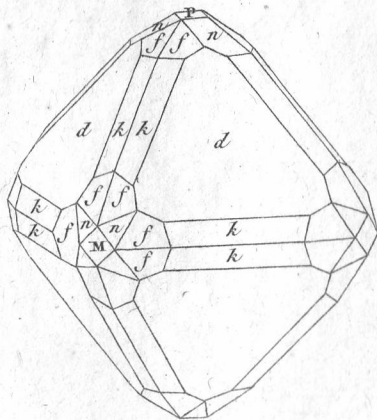


Fig. 155.

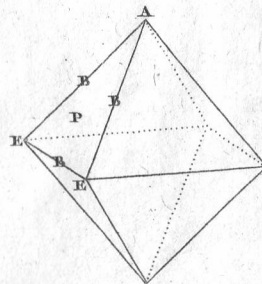


Fig. 156.

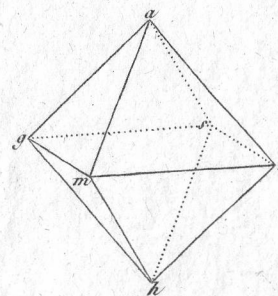
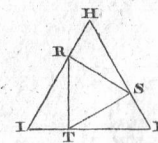


Fig. 157.



Suite du FER SULFATE

Fig. 158.

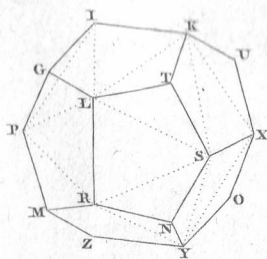


Fig. 159.

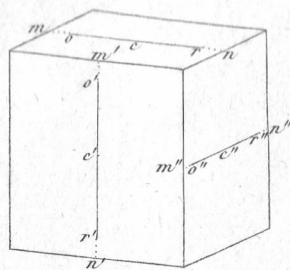


Fig. 160.

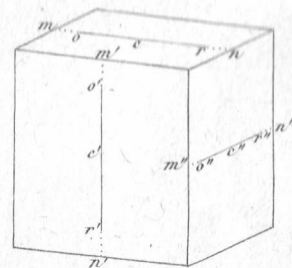


Fig. 161.

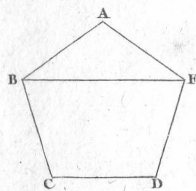


Fig. 162.

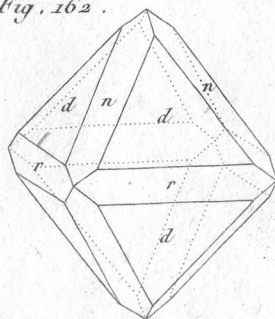


Fig. 163.

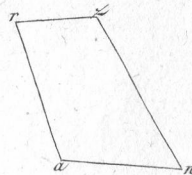
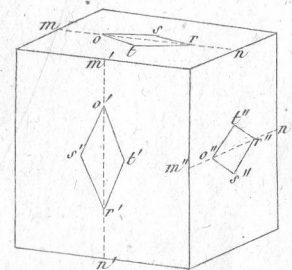


Fig. 164.



COBALT GRIS

Fig. 165.

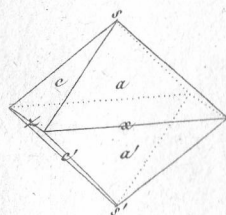


Fig. 166.

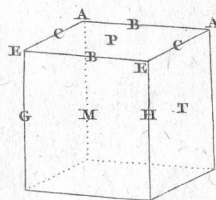
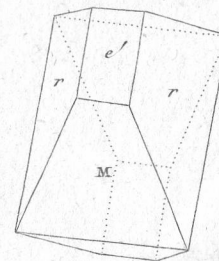


Fig. 167.



FER SULFATE

Fig. 168.

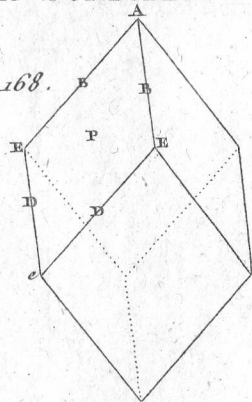


Fig. 169.

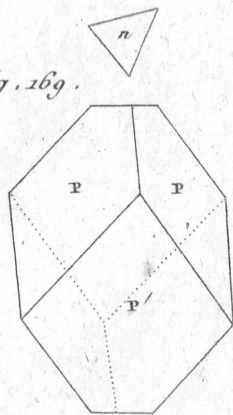


Fig. 170.

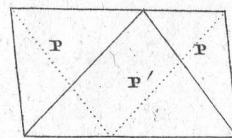


Fig. 171.

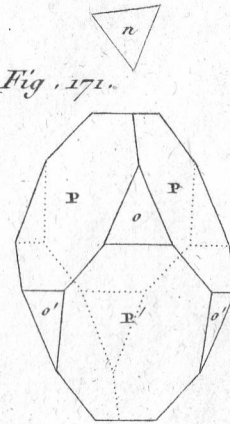


Fig. 172.

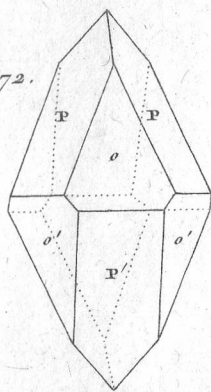


Fig. 173.

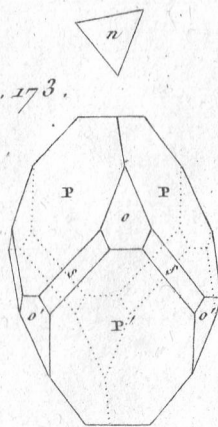


Fig. 174.

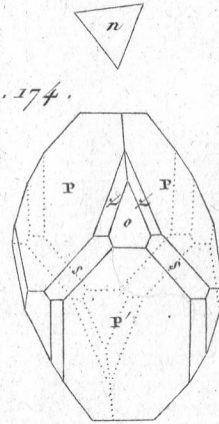
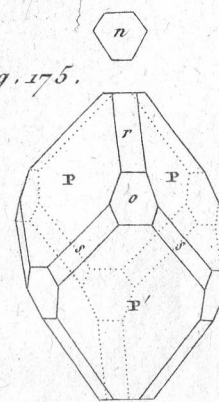


Fig. 175.



ETAIN OXYDE

Fig. 176.

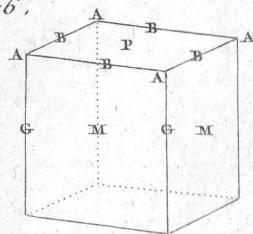


Fig. 177.

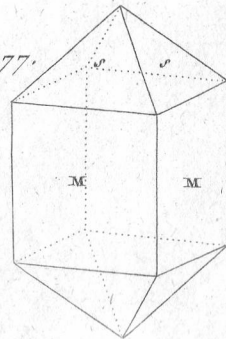
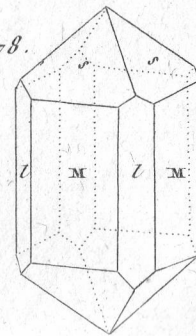


Fig. 178.



Suite de L'ETAIN OXIDE'

Fig. 179.

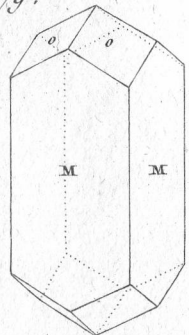


Fig. 180.

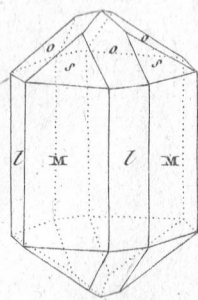


Fig. 181.

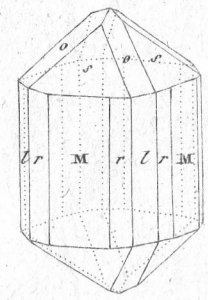


Fig. 182.

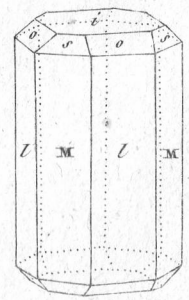


Fig. 183.

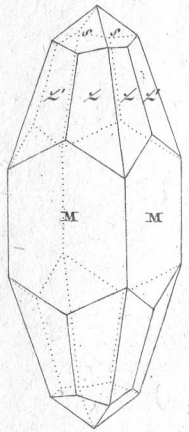


Fig. 184.

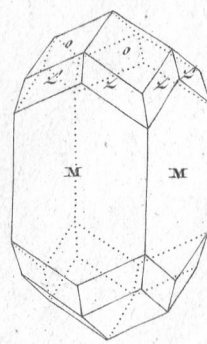


Fig. 185.

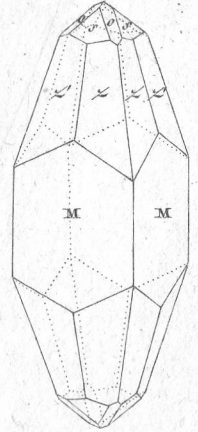


Fig. 186.

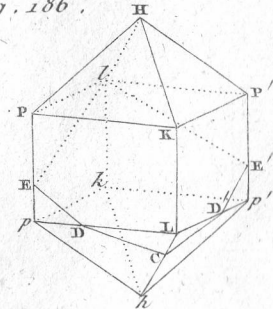


Fig. 187.

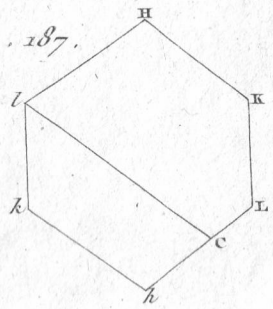
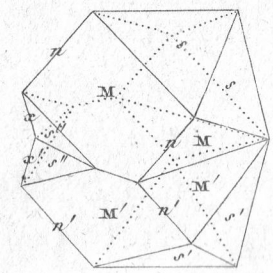


Fig. 188.



ZINC OXYDE

Fig. 189.

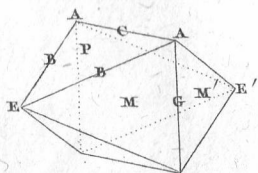


Fig. 190.

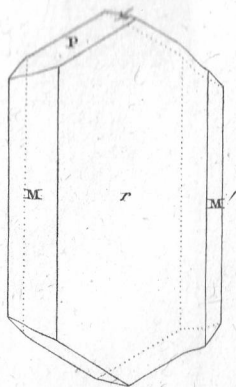
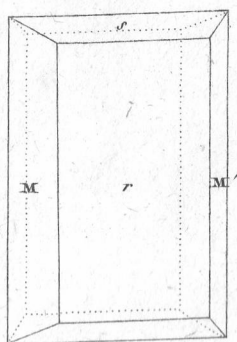


Fig. 191.



ZINC SULFURE

Fig. 192.

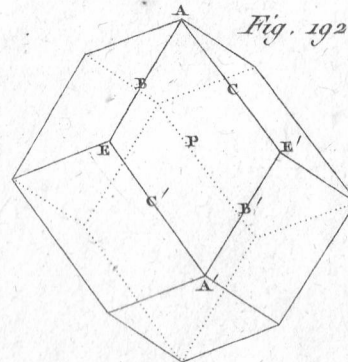


Fig. 193.

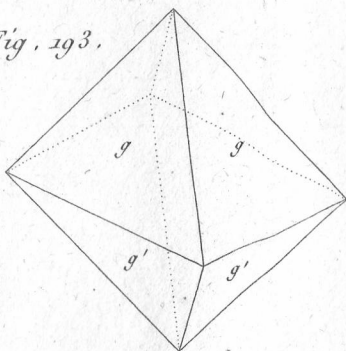


Fig. 194.

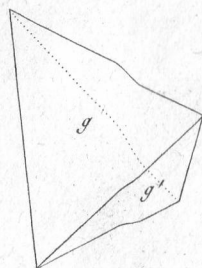


Fig. 195.

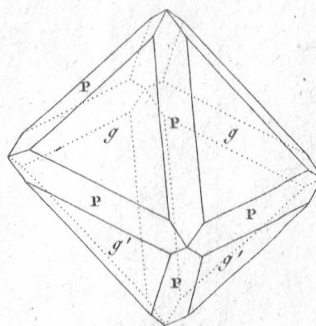


Fig. 196.

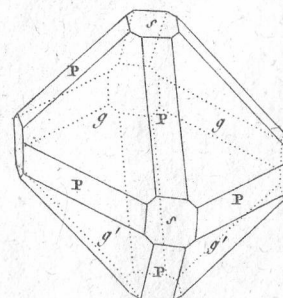


Fig. 197.

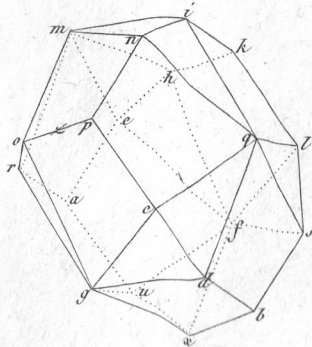


Fig. 198.

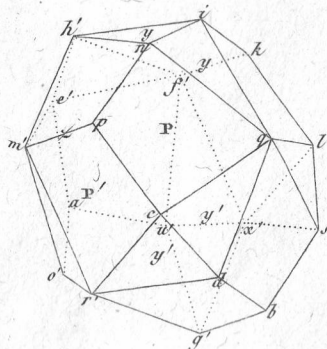
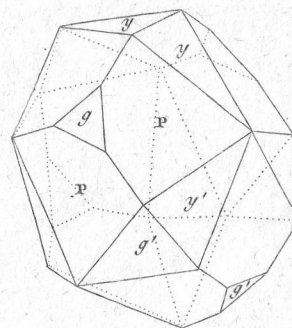
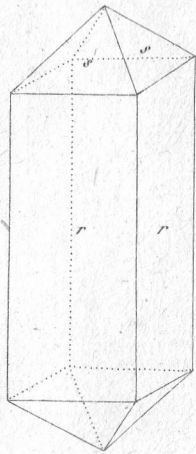


Fig. 199.



ZINC SULFATÉ

Fig. 200.

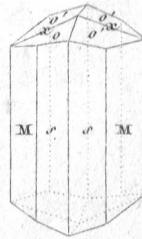


MANGANÈSE OXYDÉ

Fig. 201.

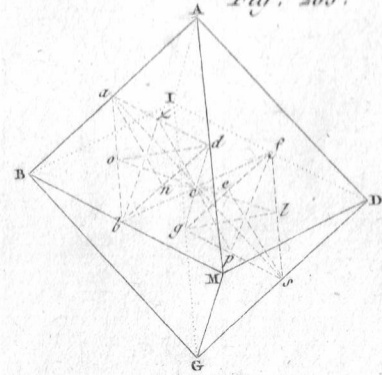


Fig. 202.



ANTIMOINE NATIF

Fig. 203.



ANTIMOINE SULFURÉ

Fig. 205.

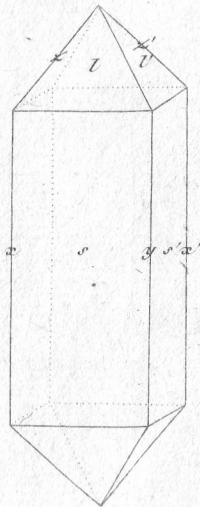


Fig. 206.

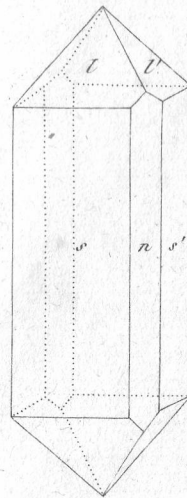


Fig. 204.

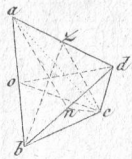
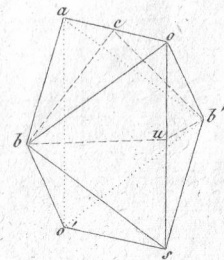


Fig. 207.



ARSENIC SULFURÉ ROUGE

Fig. 208.

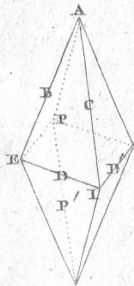


Fig. 209.

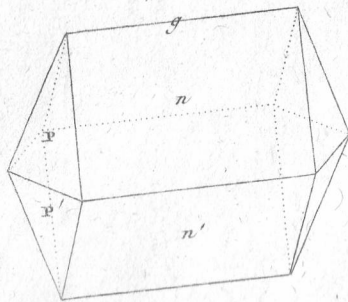


Fig. 210.

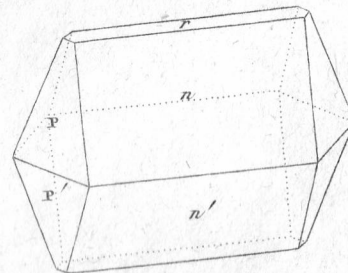


Fig. 213.

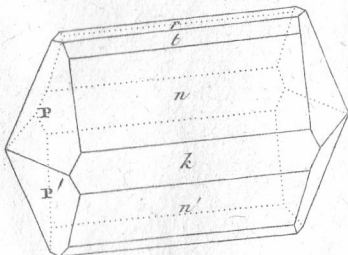


Fig. 211.

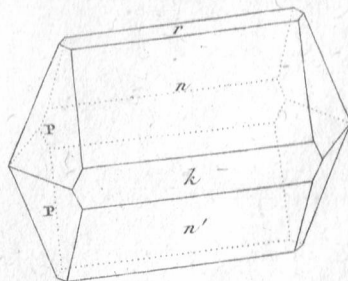


Fig. 212.

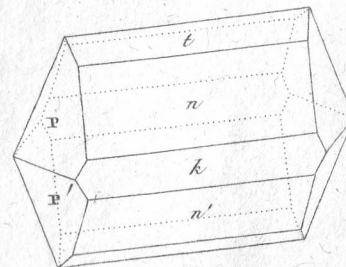
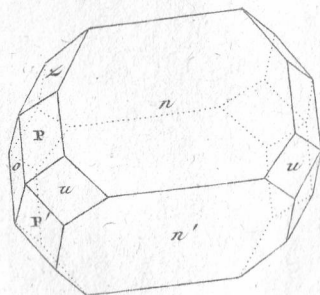


Fig. 214.



MOLYBDÈNE SULFURÉ

Fig. 216.

Fig. 215.

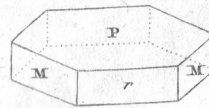
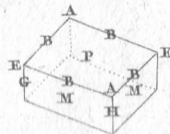
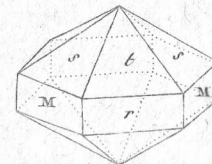


Fig. 217.



TITANE OXYDE'

Fig. 218.

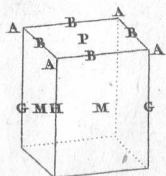


Fig. 219.

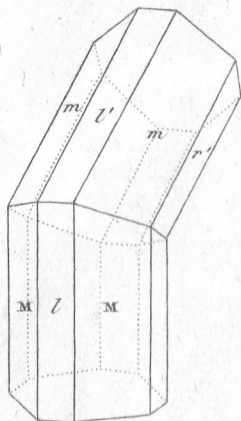


Fig. 220.

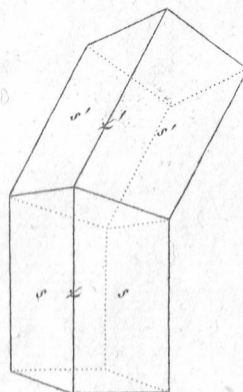


Fig. 221.

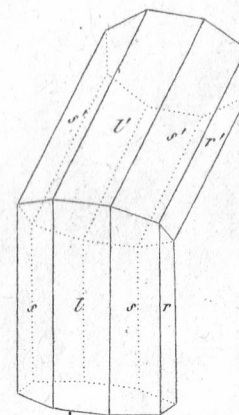


Fig. 222. TITANE SILICEO-CALCAIRE

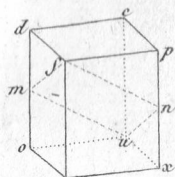


Fig. 223.

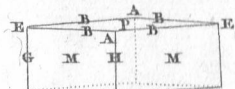


Fig. 224.

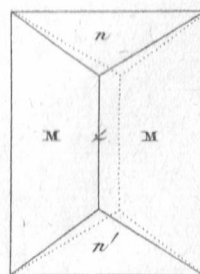
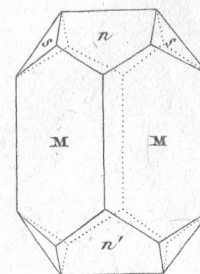


Fig. 225.



SCHEËLIN FERRUGINÉ

Fig. 226.

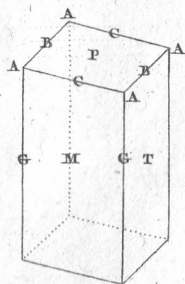


Fig. 227.

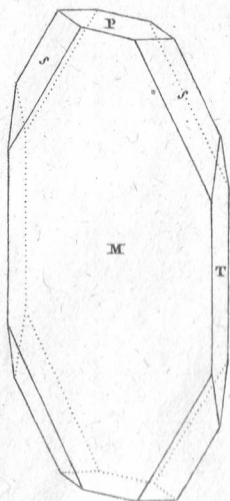


Fig. 228.

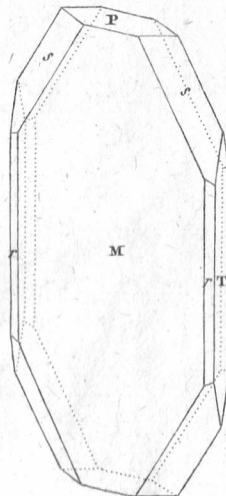
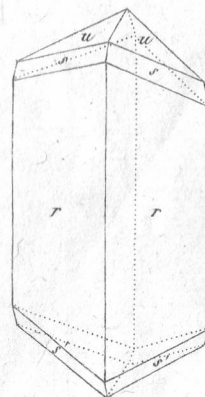
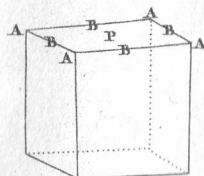


Fig. 229.



SCHEËLIN CALCAIRE

Fig. 230.



I^{ER} APPENDICE. ARRAGONITE

Fig. 232.

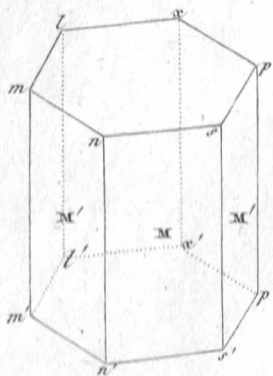


Fig. 233.

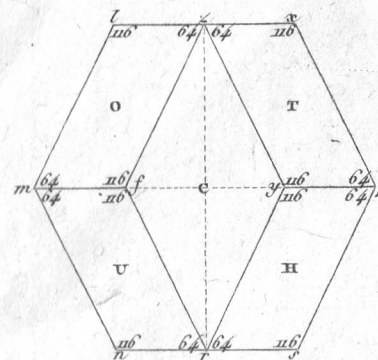
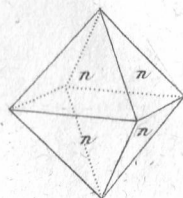
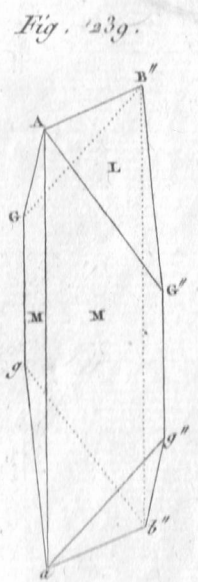
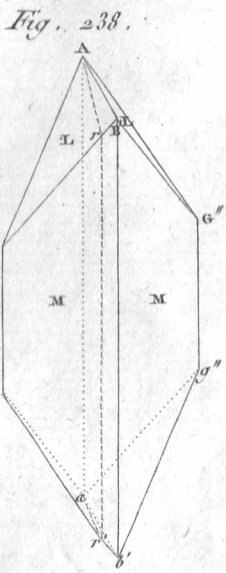
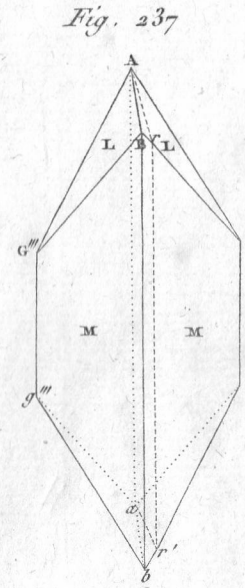
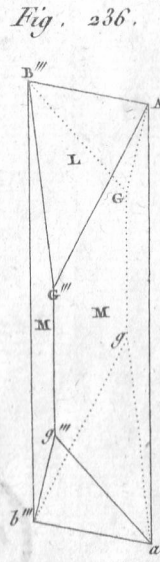
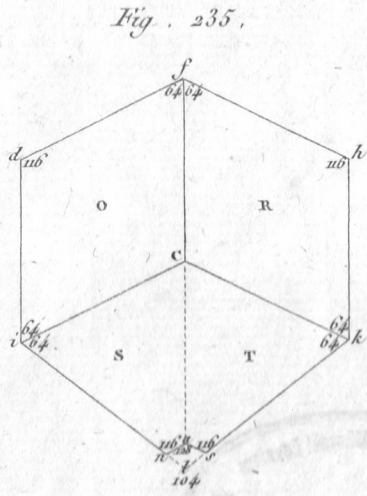
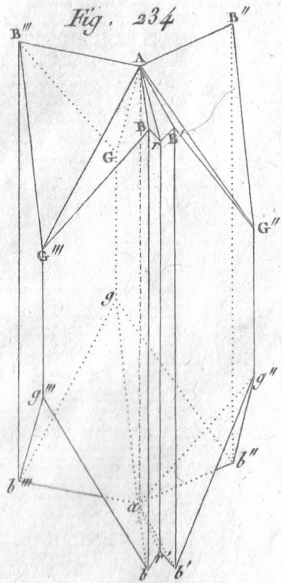


Fig. 231.



Suite de L'ARRAGONITE



SPINTHERE

