

N7 Heath-Mayfield Motorway Scheme:
Archaeological Resolution

FINAL REPORT

Excavation No.: 03E0679

SITE I, Jamestown or Ballyteigeduff Townland

Co. Laois

NGR 259962 207203 – 260284 207297

Site Director:	P. Lynch
Senior Archaeologist:	C. Duffy & C Flynn
Job No.:	1047-03-400
Client:	Kildare County Council
Date:	January 2012

Valerie J. Keeley Ltd.

SUMMARY

This report comprises the final results of the archaeological excavation of Site I, Jamestown or Ballyteigeduff townland, Co Laois as part of the N7 Heath-Mayfield Motorway Scheme. This excavation was undertaken as part of the archaeological programme for the construction of the Monasterevin Town By-Pass. The National Roads Authority through Kildare County Council financed the project. The excavation was conducted by Patricia Lynch under Licence No. 03E0679, for Valerie J. Keeley Ltd., during April 2003.

The excavated archaeological remains consisted of three hearths, Features (3, 5 & 6), a large pit Feature (13) that contained medieval pottery, and a modern furrow Feature (4), which were all situated in Trench 1 of Field One. Trench 2 of Field One contained a single hearth, Feature (7). Trench 3 of Field One contained a single hearth, Feature (9). Trench 4 of Field One contained a pair of conjoined hearths, Features (8 & 12). In Field Two a series of postholes, Features (11a-11c) and an area of burning Feature (15) were situated in Trench 5. Trench 6 of Field Two contained a single hearth Feature (10).

The results of this excavation indicate human settlement and possible metal working activity the early medieval period.

CONTENTS

SUMMARY	i
LIST OF PLATES	iii
LIST OF FIGURES	iii
LIST OF TABLES	iii
1.0 INTRODUCTION	1
2.0 THE SCOPE OF THE PROJECT	1
3.0 BACKGROUND	2
4.0 LOCATION	3
5.0 EXCAVATION	3
5.1 Introduction	3
5.2 Trench 1	4
5.3 Trench 2	6
5.4 Trench 3	7
5.5 Trench 4	7
5.6 Trench 5	8
5.7 Trench 6	8
6.0 SUMMARY	9
7.0 DISCUSSION: METAL WORKING	9
8.0 CONCLUSION	11
9.0 BIBLIOGRAPHY	12
10.0 ACKNOWLEDGEMENTS	12
Appendix 1: List of Contexts	14
Appendix 2: List of Finds	17
Appendix 3: Feature Catalogue	19
Appendix 4: Slag Report, by Dr Tim P. Young	21
Appendix 5: Pottery Report, by Patrick Hall	39
Appendix 6: Clay Pipe Report, by Joe Norton	46
Appendix 7: Site Matrix	48
Plates	
Figures	

LIST OF PLATES

Plate 1	Section of Feature 3, from south
Plate 2	Section of Feature 5, from east
Plate 3	Post - excavation of Feature 7, from northeast
Plate 4	Post - excavation of Feature 12 (left) and feature 8, from northeast
Plate 5	Section of Feature 9 from north
Plate 6	Section of Feature 10, from west
Plate 7	Post - excavation of Feature 11, from north
Plate 8	Section of Feature 13, from west

LIST OF FIGURES

Figure 1	Location of Site I on Discovery Map
Figure 2	Location of Site I in relation to new N7 route
Figure 3	Trench layout, Site I
Figure 4	Post - excavation of Trench 1
Figure 5	Post - excavation of Trench 2
Figure 6	Post - excavation of Trench 3
Figure 7	Post - excavation of Trench 4
Figure 8	Post – excavation of Trench 5
Figure 9	Post – excavation of Trench 6
Figure 10	Sections of Features from Trench 1
Figure 11	Sections of Features from Trench 2
Figure 12	Sections of Features from Trench 3
Figure 13	Sections of Features from Trench 4
Figure 14	Sections of Features from Trench 6

LIST OF TABLES

Table 1	List of Archaeological excavations prior to construction
Table 2	Records Inventory
Table 3	Comparison of smelting furnace dimensions with previous examples. Figures in grey boxes are site average.
Table 4	Comparison of average fragment weight and assemblage type for residues recovered from smelting furnaces.

1.0 INTRODUCTION

This report details the results of archaeological excavation carried out prior to the construction of the N7 Heath-Mayfield Motorway Scheme at Jamestown or Ballyteigeduff townland, on behalf of Kildare County Council and the National Roads Authority. This site was excavated as part of the resolution of archaeological sites on the route of the N7 Heath-Mayfield Motorway Scheme which extended from Mayfield townland in Co. Kildare westwards to Greatheath townland in Co. Laois. It had not been previously recorded and was discovered during archaeological test trenching along the road corridor. Site I was identified under the same contract during advanced centreline testing by Eoghan Moore under Licence No.03E0126. The project was funded by European Union Cohesion funds and by the National Development Plan fund with the National Roads Authority acting as the funding agency. Archaeological excavations were conducted by Patricia Lynch for Valerie J. Keeley Ltd. on behalf of Kildare County Council.

2.0 THE SCOPE OF THE PROJECT

The proposed N7 Heath-Mayfield Motorway Scheme extended from Mayfield townland at the western end of the N7 Kildare Town By-pass westwards to Greatheath townland at the eastern end of the N7 Portlaoise By-pass.

The works preserved by record, archaeological deposits and structures that could not be preserved *in situ* during the construction of this new road. Excavations were conducted in accordance with both the terms of the Contract between Kildare County Council and Valerie J Keeley Ltd. and the terms of the Code of Practice agreed between the National Roads Authority and the Minister of Arts, Heritage, Gaeltacht and the Islands, (Govt of Ireland 2000). The excavations complied with the Policy and Guidelines on Archaeological Excavation (Govt of Ireland 1999).

This report describes one of a series of excavations undertaken prior to road construction. The sites were identified following paper survey, field inspections and centreline testing.

Licence	Site name	Site #	Director	Site Type
03E 0151	Ballydavis	1	Grace Fegan	Prehistoric Burial Complex
03E 0151	Ballydavis	1 ext	Grace Fegan	Continuation of Site 1
03E 0966	Ballydavis	B	Ros O' Maolduin	Irregular shaped feature with large pieces of charcoal and a circular feature with occasional charcoal flecks
03E 0429	Morett	2	Eoghan Moore	Ancient Roadway
03E 0636	Morett	C	Eoghan Moore	Complex of features

Licence	Site name	Site #	Director	Site Type
03E 0461	Morett	D	Eamonn Cotter	Complex of features
03E 0804	Morett	E	Eoghan Moore	Fulacht Fiadh
03E 0633	Cappakeel	F (West)	Ros O' Maoldúin	Linear feature & 2 postholes
03E 0603	Cappakeel	F (East)	Audrey Gahan	Prehistoric Landscape
03E 0662	Ballyshaneduff or The Derries	G	Thaddeus C. Breen	Fulacht Fiadh
03E 0678	Ballyshaneduff or The Derries	H (west)	Gary Conboy	Complex of features
03E 0690	Ballyshaneduff or The Derries	H (east)	John Channing	Complex of features
03E 0679	Jamestown or Ballyteigeduff	I	Patricia Lynch	Complex of features
03E 0350	Kill	20 K	John Channing	Cillín, Hearth
03E 0602	Lughil	Site L	John Channing	Charcoal spread
03E 0571	Ballyfarsoon	Site M	Eamonn Cotter	Fulacht Fiadh
03E 0634	Lughil	Site N	John Channing	Charcoal spreads
03E 0635	Kill	Site O	John Channing	Unidentified feature & field boundary?
03E 0905	Ballydavis	Site P	Colum Hardy	Small Complex of Features
03E 0826	Morett	Site Q	Colum Hardy	Linear feature & 2 postholes

Table 1: List of Archaeological excavations prior to construction

3.0 BACKGROUND

Prior to the excavation that this report is concerned with, archaeological centre line investigations had been conducted by Eoghan Moore under the same contract (Licence No.03E0126). The centreline investigations identified several areas, deposits and features with archaeological potential. The excavation took place under archaeological supervision, in accordance with Licence No.03E0679. The site was excavated by a team consisting of a site director (the author), one supervisor, four assistants and two general operatives.

Six trenches that contained archaeological material were excavated. These trenches were situated in two fields at National Grid Co-ordinates 259962E 207203N and 260284E 207297E. The site was located on a slight slope (66.42m OD).

The primary records of these excavations consist of written and drawn records, photographs, survey data, finds and samples (Table 2). The stratigraphic record was primarily made on context logs and context sheets, of the standard type used by Valerie J. Keeley Ltd. (VJK). These are supplemented by information from the site diary and notebooks.

Form	Pages	Number issued or Taken
Context log	2	42
Feature Log	1	16

Photograph log (Rolls)	3	60
Plan Log	1	18
Sample Log	2	44
Context Sheets	52	

Table 2: Records Inventory

In the course of the excavation, forty-two context numbers were assigned to spreads and fills. Sixteen feature numbers were assigned to the sixteen cuts.

4.0 LOCATION

The site consists of a number of archaeological features, located in the townland of Jamestown or Ballyteigeduff (*Bhaile Thaidhg Dhuibh* – www.logainm.ie), Parish of Lea, Barony of Portnahinch, Co. Laois between Chainage 32+700 & 33+040 and at National grid co-ordinates between 259962E 207203N and 260284E 207297E. It was not previously recorded as a RMP site. It is not listed in 'Heath-Mayfield Scheme, Route S2 Alternative, Archaeological Assessment for EIS' Valerie J. Keeley Ltd, Archaeological Consultancy, April 1999.

The site was located in agricultural land which had been under pasture, and was bisected by a local road.

5.0 EXCAVATION

5.1 Introduction

Forty two context numbers and sixteen feature numbers were allocated during the course of the excavation and these numbers are cited in the text below in bold script and brackets thus: **(10)**.

5.1.1 Feature and Context description

Six trenches were investigated and the findings are listed below. Feature **(1)** was used to describe the topsoil that overlay the entire area of excavation and Feature **(2)** was used to describe the subsoil that underlay the entire site.

5.2 Trench 1

Trench 1 was the most western trench and located between NGR 259991E 207198N and NGR 259993E 207188N (figure 3), and contained four archaeological features, features **(3, 5, 6, 13)** and a modern field drain, feature **(4)** (figure 4).

Feature **(3a & 3b)** (66.42OD) consisted of a sub oval hearth **(3a)** and collapsed rabbit burrow **(3b)** and was orientated NW/SE. The hearth continued outside the eastern margin of the trench (balk) and

therefore the trench was widened to include the complete feature. Upon excavation by hand the entire feature measured maximum 2.45m in length and 1.33m in width and 0.2m in depth (figure 4). The hearth was dug directly into the subsoil and contained five distinct layers, Contexts (37 – 41). Context (40) measured 0.2m in depth and consisted of a loose, sandy light brown fill that contained inclusions of pebbles and charcoal. On its eastern extent, Context (40) abutted Context (38).. Context (38) was the central fill of the hearth and consisted of a loose charcoal enriched soil that measured 8cms in depth (figure 10, plate 1). Context (39), feature (3a) abutted Context (38) at its southern extent Context (39) measured 0.06m in depth, and consisted of a compact light brown fill with inclusions of charcoal and oxidised soil.

The uppermost layer of Feature (3a & 3b) was Context (37) which overlay Context (38). Context (37) measured 0.1m in depth and consisted of a loose charcoal enriched soil that contained 70% of charcoal inclusions. A collapsed rabbit burrow feature (3b) was located at the northwestern part of the feature. This contained one fill, Context (41) that consisted of a loose, grey/light brown fill that contained charcoal inclusions and measured 0.3m deep (figure 4).

Feature (4) (66.47 OD) consisted of the remains of a modern field drain that was located 2.2m to the southwest of feature (3) and 1m to the West of Feature (5). The feature measured 2.27m in length, 0.46m in width and 0.04m in depth, within the excavation area, and was dug into the subsoil (figure 4).

Feature (5) (66.42 OD) consisted of a hearth, and was sub-circular in plan. Upon excavation by hand the entire feature measured maximum 1.2m in length, 1m in width and 0.24m in depth (figure 4). The feature was dug directly into the sub soil and contained four distinct layers, contexts (19 – 22). The feature consisted of two central fills, Contexts (20 & 22). Context (22) was the basal layer and consisted of a loose, dark brown and red soil that indicated in-situ burning. The depth of the layer was 0.05m. The central/ uppermost layer, Context (20) measured 0.08m in depth and consisted of a mix of black charcoal enriched soil and red burnt soil. Context (19) abutted Contexts (20 & 22) to the west and consisted of a fill of charcoal enriched soil and burnt soil that measured 0.07m in depth. It also contained 10% inclusions of unburnt pebbles. Context (21) abutted Contexts (20 & 22) to the east and also consisted of a fill of charcoal enriched soil and burnt soil. It also contained 5% inclusions of unburnt pebbles and measured 0.12m in depth (figure 10, plate 2). Several depressions were located in the base of the heath. These possibly represent stone sockets, as there was no difference in the fill and possibly may represent human backfilling following the abandonment of the site.

Feature (13) (66.36OD) was the largest feature in Trench 1, and was located 0.7m to the south of Feature (5) and measured 2.96m in length, 2.52m in width and 0.30m in depth (figure 4, plate 8). The

feature contained a single layer, Context **(16)** that consisted of a loose, sandy grey fill with the occasional inclusion of charcoal (figure 10). Two fragments of medieval pottery (03E0679:5 & 03E0679:6) and one single bovine molar, Sample # 17 were recovered from within the context. Several large stones were at the base of the feature. The position of the stones did not suggest a deliberate pattern.

Feature **(6)** (66.31OD), was the most southern feature located 0.28m to the south of Feature **(13)**, and was orientated NW/SE (figure 4). Feature **(6)** consisted of a kidney shaped hearth that contained six distinct abutting layers, Contexts **(26 – 31)** (figure 10). Upon excavation by hand the feature measured 2.5m in width by 1.5m in length and 0.15m in depth.

Context **(26)** was the most western layer within Feature **(6)**, and overlay both Contexts **(27 & 28)**. It consisted of a clearly defined loose, large grained grey/brown soil that measured 0.15m in depth. Evidence of burning was present at the western margin of the context. Context **(27)** underlay Context **(26)** and overlay Context **(28)**. Context **(27)** consisted of compacted charcoal enriched soil (70% charcoal) and varied in depth between 0.04m – 0.14m. Context **(28)** underlay Context **(26)** and consisted of several possible stone sockets in the subsoil that was filled with a mix of charcoal enriched soil and red/orange burnt soil (figure 10).

Context **(29)** was abutted by Context **(27)** to the west and Context **(30)** to the east, and consisted of a charcoal enriched soil that contained inclusions of ash. The layer measured 0.1m in depth and overlay the subsoil. Context **(30)** was abutted by Context **(29)** to the west and Context **(31)** to the east. Context **(30)** consisted of a light brown compact sandy soil that contained inclusions of small, unburnt pebbles and measured 0.15m in depth. Context **(31)** consisted of a thin brown/grey sticky layer that contained no evidence of burning or charcoal inclusions. These contexts may represent human backfilling or refilling following the abandonment of the site.

5.3 Trench 2

Trench 2 was located between 260036E 207221N and 260040E 207212N and contained one archaeological feature, Feature **(7)** (figure 3 & 5).

Feature **(7)** (67.40 OD) was the only feature of archaeological significance in Trench 2. It was a hearth, and was sub-square in plan and contained seven distinct contexts, **(10 – 13, 34 – 36, 42)**. The feature continued outside the western margin of the trench (balk) and therefore the trench was widened to include the complete feature. Upon excavation by hand the entire feature measured maximum 2.85m in

length, 2.20m in width and 0.2m in depth. The feature was dug directly into the sub soil (figure 5, plate 3).

Feature (7), Context (10) consisted of a charcoal enriched soil that contained c. 50% charcoal and also contained inclusions of small pebbles. The depth of the Context (10) varied from 0.03m – 0.1m. Context (11) directly underlay Context (10), consisted of a mix of burnt soil and ash and measured 8cms in depth. Context (12) was the central context of Feature (7), and abutted Context (10), Context (11) and Context (13). Context (12) consisted of a mix of burnt soil, charcoal and ash. This was interspersed with small pebbles and measured maximum 0.16m. Context (13) consisted of loose dark brown/black charcoal enriched soil that measured 0.09m in depth (figure 11).

Along the northern edge of Feature (7) a possible pit, or dumping area was identified (7a). Feature (7) contained three distinct contexts (34-36). Context (34) was located at the side and base of the eastern edge of the feature and consisted of loose brown silt and measured 0.01 – 0.15m in depth. The main, and central fill of the feature, Context (35) overlay Context (34) and consisted of a loose brown silt and soil mix that contained occasional inclusions of charcoal (10%) with a maximum depth of 19.5cms. Context (36) was located in the northwest, of Feature (7), and abutted Context (35). Context (36) was similar to Context (34), consisting of brown silt that measured between 0.09 – 0.19m in depth (figure 11).

5.4 Trench 3

Trench 3 was located between NGR 260082E 207239N and 260086E 207229N and contained two adjoining archaeological features, Features (8 & 12) that were located towards the southern end of the trench (figure 3 & 6).

Feature (8) (67.70 OD) consisted of sub-circular iron smelting furnace, that was dug into the subsoil. Feature (8) measured 0.55m in width, 0.6m in length and 0.2m in depth and contained three different contexts (4, 5, 14) (figure 6 & 12, plate 4). The basal layer, Context (14) lined almost the entire feature and consisted of a compact layer of red burnt soil that measured 0.04 – 0.06m in depth. Context (5) overlay Context (14) to the south and lined the cut at the centre of the base of the feature. The fill consisted of a very loose charcoal enriched soil with some slag inclusions. It measured between 0.18m

– 0.20m in depth. Context **(4)** overlay Context **(14)** to the north and consisted of a mix of black charcoal enriched soil and red burnt soil that measured 0.05 – 0.1m in depth.

Feature **(12)** (67.93 OD), adjoined Feature **(8)** and consisted of an iron smelting furnace that contained two contexts, **(32 & 33)** and was dug into the subsoil (figure 6 & 12, plate 4). Upon excavation by hand the feature measured 0.7m in length, 0.45m wide and 0.10m deep. Context **(32)** was the main fill and consisted of a charcoal enriched soil (70%) with iron slag (Sample no. 23). Context **(23)** measured 0.08m in depth. Context **(33)** underlay context **(32)** and consisted of very red burnt subsoil that measured 0.02m in depth.

5.5 Trench 4

Trench 4 was located between 260140E 207234N and 260143E 207225N (figure 3) and contained a single archaeological feature, Feature **(9)** (figure 7). During the initial clean back of the trench an iron nail (Find no. 03E0679:1) and the fragment of an upper oyster shell (Find no. 03E0679:2) was recovered.

Feature **(9)** (67.79 OD) was a shallow oval hearth that was dug into the burnt subsoil Feature **(9)** measured 1.57m in width, 1.20m in length and 0.20m in depth, and contained a single fill Context **(17)**. Context **(17)** consisted of a charcoal enriched soil (60% charcoal) that also contained pieces of red/orange burnt soil. Upon removal of the context two possible postholes/stone sockets were identified. Their fill was also Context **(17)**. A large stone was present within the context, to the west of the feature (figure 13, plate 5).

5.6 Trench 5

Trench 5 was located in Field 2 and was located between 260237E 207285N and 260239E 207280N (figure 3 & 8) and contained two features of archaeological potential, Features **(11 a-b, 15)**.

Feature 11 consisted of two postholes, **(11a & 11b)** that were located in an area of burnt subsoil (figure 8, plate 7).

Feature **(11a)** (67.281 OD) consisted of 'V' shaped stake hole dug directly into the subsoil that measured 0.5m in length, 0.2m in width and 0.13m in depth and contained a single fill, Context **(2)**. This context consisted of a mix of charcoal enriched soil and subsoil and included charcoal inclusions (10%).

Feature **(11b)** was located 0.12m to the south east of feature **(11a)** and consisted of an sub-circular feature dug into the subsoil, possibly two postholes that contained a single fill, Context **(6)**. The fill consisted of a charcoal enriched soil that also contained subsoil.

Feature **(11c)** abutted feature **(11b)** on its southeastern side. It originally was considered to be part of a plough furrow filled with a single context **(3)**. Upon excavation by hand the feature was discovered to be a track mark of a tracked bulldozer, filled with topsoil. It was therefore considered to be of no archaeological significance.

Feature **(15)** was located 0.85m from feature **(11)** and consisted of a diamond/lozenge shaped area of burning, 0.35m long by 0.23m wide by 0.06m deep, with a single deposit, Context **(18)**. The deposit consisted of charcoal enriched soil mixed with ash and measured 6cms deep. This overlay the subsoil that was burnt, indicating the remains of a fire.

5.7 Trench 6

Trench 4 was located between 260261E 207286N and 260262E 207281N (figure 3) and contained a single hearth that was dug into the subsoil, Feature **(10)** (66.81OD) (figure 9).

Feature **(10)** consisted of three distinct layers, Contexts **(7 – 9)**.

The basal layer, Context **(9)** was the natural subsoil that had been turned red as a result of direct contact with heat and had a biscuit like texture. It is possible that this layer was a lining of subsoil for the hearth. Context **(8)** overlay this context and consisted of charcoal enriched soil that contained 70% charcoal and inclusions of burnt soil that was 0.02 – 0.04m in depth. The uppermost layer, Context **(7)** was between 0.04m and 0.07m in depth and consisted of a mix of charcoal enriched soil and ash (figure 14, plate 6).

6.0 SUMMARY

The excavated archaeological remains consisted from the west to the east of:

Field One

Trench 1, three hearths, Features **(3, 5 & 6)**, a large pit Feature **(13)** that contained medieval pottery and a modern furrow Feature **(4)**.

Trench 2, a single hearth, Feature **(7)** and a feature of no archaeological significance, Feature **(14)**.

Trench 3, a pair of iron smelting furnaces, Features **(8 & 12)**.

Trench 4, a single hearth, Feature **(9)**.

Field Two:

Trench 5, series of postholes, Features (11) and an area of burning, Feature (15).

Trench 6, a single hearth, Feature (10).

7.0 DISCUSSION: METAL WORKING

Iron working has been increasing in profile in recent years, with the influx of new sites excavated and significant analysis of iron working assemblages, but was poorly studied in the past (Edwards 1990, 86). In fact, the analysis of iron working materials from excavations has become far more widespread than previously was the case. Recent publications are challenging the traditional view of iron working in Ireland, in relation to Britain and Europe. New site types, artefacts and new analysis is advancing knowledge of the processes involved and date range of metal working technology in Ireland. Experimental and ethnological comparisons carried out by Tylecote (1986) and Crew (1991) and more recently by Young (*forthcoming*) have greatly advanced our knowledge of the processes and the archaeological signature that is left behind.

A total of eight sites from the N7 Heath - Mayfield Motorway Scheme, yielded evidence of iron working activity, mostly from *in situ* or adjacent iron working features in Counties Kildare and Laois. The assemblages represent various processes, date ranges and significance. Seven of the eight sites provided evidence for iron-smelting, with a wide range of provisional dates from Iron Age to Medieval. Two of those sites also provided evidence for iron-working (smithing), as did the eighth site. The slags indicate an essentially similar iron-smelting technology across these sites and periods, employing a slag-pit shaft furnace. The results of the analysis of these assemblages by Dr. T. Young contributes into a broader emerging study of archaeometallurgy and the activities related to iron and metal working general from the past (see Appendix 5).

The bloomery iron working process consisted of three constituent activities: smelting is a process whereby iron minerals or ores are reduced and broken up by reaction with burning fuel (charcoal), leading to the formation of an iron bloom (billet) and liquid slag waste and residues. The iron bloom has to be refined by hammering to drive out remaining slag particles and this part of the process is known as bloom or primary smithing. The bloom is forged into shape, often in an open hearth or forge, with a forced air supply, usually by bellows. Finally, the metal was worked into artefacts using various heating, hammering, cutting, and twisting techniques, in a process known as secondary smithing. Both smelting and smithing produce waste residues such as slag.

Limited evidence from a hand full of sites appears to now show that iron working may have been undertaken in Ireland as early as the 7th century BC, and possibly even the 8th century BC, which is more usually classified as the Bronze Age, however definitively by the 5th century BC (Carlin 2008, 104).

A possible bloom smithing hearth and charcoal production pit at Rossan 6, Co Meath, was radiocarbon dated to 820-780 cal BC (Beta- 177434; Carlin *et al* 2008, 104/137), whilst metallurgical residues from a pit with Late Bronze Age pottery (dated to c.800 BC) at Kinnegad 2, Co Meath, dated by associated charcoal, returned a radiocarbon date of 820-410 cal BC (Beta-177426; Carlin *et al* 2008, 104/136). However, a furnace from the same site returned at date of 400-210 cal BC (Carlin 2008, 101-2). An iron smithing site, with nails and other artefacts present, excavated at Parksgrove 1, Co. Kilkenny was radiocarbon dated by oak charcoal to 757–261 cal BC (GrN-25788; Stevens 2005). A possible smithing hearth was recorded at Moyvalley 1, Co. Kildare and dated to 360-60 BC (Beta-177437; Carlin *et al* 2008, 104, 136). Early iron smelting furnaces have also been excavated at Carrickmines Great, Co. Dublin, dated 360-100 cal BC (Ó Drisceoil 2007, 27); Cherryville 12, Co. Kildare, dated 320-200 cal BC (Young 2008a), Newrath Site 35, Co. Kilkenny, dated 400–200 cal BC / 350–40 cal BC (J. Eogan *pers comm*), Johnstown 3, Co Meath dated 420–230 cal BC (Beta-177442; Carlin *et al* 2008, 104, 136)

9.0 CONCLUSION

The archaeometallurgical evidence indicates that although the slag assemblage from this site was extremely limited, it clearly demonstrates that iron smelting was undertaken in the form of slag pit furnaces or more correctly a type of shaft furnace. The very basal part of these furnaces would accumulate deposits of ash and unburnt fuel fragments and fine residues. From time to time the furnaces were not thoroughly cleaned, and as a result this material might accumulate in the basal pit, giving rise to the apparently in-situ deposits recorded from Jamestown or Ballyteigeduff, Site I (see Appendix 4). Some sites, such as Celbridge 5 (Young 2003) have small furnaces with diameters of 0.3m, whereas the largest furnaces such as Jamestown or Ballyteigeduff Site I, (03E0679) have diameters of approximately 0.5m or slightly more. There is reasonable expectation that the furnaces from Ballydavis 2 (03E0151) are Iron Age, whereas some of the larger furnaces are interpreted as being medieval, but whether there is a general trend in the size of furnaces will not be revealed until further C14 dates are achieved. The large size of the slag pit furnaces may be unusual. Young points to a possible trend in the Iron Age from other sites such as Cloncollig, Co. Offaly and Adamstown 1, Co Waterford (Young 2008b, 2009). However, other Iron Age sites such as Derrinsallagh 4, Co. Laois, had an external working hollow arch, but had smaller diameter furnaces of approx 0.3m (Young 2008c). These smaller furnaces seem to appear from the 1st century BC and continue well into the first millennium AD. The smaller furnace pits fit both in terms of size and date with an emerging group of earlier Iron Age furnaces with slag pits between 0.4-0.5m diameter (Young 2009)

This site has a number of features of archaeological origin. The most common features being the number of hearths and areas of burning. Due to the nature of their discovery within individual test trenches it is difficult to ascertain the original nature, function and date of a number of these hearths, pits and postholes. It may have been the case that these other hearths and pits were associated with metalworking. The earliest phase of activity on site is represented by the metalworking evidence. Fragments of iron slag were recovered from Feature (8) and Feature (12), (slag pit furnaces) suggesting at least that metal working was taking place in the area. The latest phase of activity was represented by the large pit, Feature (13) which contained two fragments of medieval pottery classified as Dublin Glazed Ware: Fabric 002 (Find no. 03E0679:5) and Dublin Hand-Built Ware: Fabric 004 (Find no. 03E0679:6). These sherds suggest a date in the late 12th -13th centuries for Fabric 004 while it is thought that Fabric 002 is later, dating to the early 13th century perhaps continuing into the 16th century (see Appendix 6). The close proximity of this medieval pit to the three hearths may indicate some form of contemporary activity but without radiocarbon dating this will remain as speculation.

9.0 BIBLIOGRAPHY

- Beckett, J.K., 1979, *Planting Native Trees and Shrubs*. Jarrold & Sons Ltd, Norwich.
- Carlin, N. 2008 "Ironworking and production" in N. Carlin, L. Clarke & F. Walsh (eds) *The archaeology of life and death in the Boyne floodplain*. NRA Scheme Monographs Series 2 Bray: Wordwell P87-112
- Comerford, M (1883) *Collections relating to the Dioceses of Kildare and Leighlin*
- Crew, P 1991 'The experimental production of prehistoric bar iron', *Historical Metallurgy* 25, 21–36.
- Edwards, N. 1990 *The Archaeology of Early Medieval Ireland*.
- Ó Drisceoil, C. 2007 Life and death in the Iron Age at Carrickmines Great, Coounty Dublin in *Journal of the Royal Society of Antiquaries of Ireland* 137. 5-28
- Nelson E.C., 1993 *Trees of Ireland*. The Lilliput Press, Dublin.
- Schweingruber, F.H. 1990. *Microscopic Wood Anatomy*. 3rd edition. Birmensdorf: Swiss Federal Institute for Forest, Snow and Landscape Research
- Stevens, P. 2005 'New evidence for the Bronze and Iron Ages in County Kilkenny: the 1999 gas pipeline excavations' *Old Kilkenny Review* 57. 7-31
- Warner, R.B., 1987, "A proposed adjustment for the « Old-Wood Effect »", in Mook, W. & Waterbolk, H. (eds) *Proc. 2nd Symp of 14C & Archaeology*, Groningen 1987, 29, 159-172.
- Webb, D.A., 1977, *An Irish Flora*. Dundalgon Press Ltd, Dundalk.

Young, T.P. 2003. Evaluation of slag from Celbridge Site 5, County Kildare (01E0306). Geoarch Report 2003/07. 5pp.

Young, T.P. 2008a. Archaeometallurgical residues from Cherryville Site 12, Kildare Bypass. 01E0955 *GeoArch Report 2007/24*. 33pp

Young, T.P. 2008b. Evaluation of metallurgical residues from Cloncollig 2, Co. Offaly, NTB06, A033/E2850137. GeoArch Report 2008/09. 4pp

Young, T.P. 2008c. Evaluation of Archaeometallurgical residues from the M7/M8 Contract 2: Derrinsallagh 1 (E2177). *GeoArch Report 2008/21*.

Young, T.P. 2009 Evaluation of Archaeometallurgical residues from the M7/M8 Contract 1: Leap (E2131) GeoArch Report 2009/03

10.0 ACKNOWLEDGEMENTS

The excavation was facilitated by the Kildare County Council National Road Design Office, NRA, EU, Dúchas & National Museum.

The site crew deserve recognition for braving inclement weather conditions to ensure a speedy resolution to the site, while the support facilities of V. J. Keeley Ltd. ensured smooth progress.

APPENDIX 1
LIST OF CONTEXTS

LIST OF CONTEXTS

No.	Type	Trench/Field no.	Description
1	Site overburden	All	Site clearance
2	Subsoil	All	Subsoil
3	Fill	Five/One	Fill of F11
4	Fill	Three/Two	Fill of F8
5	Fill	Three/Two	Fill of F8
6	Deposit	Five/One	Fill of F11
7	Fill	Six/One	Fill of F10
8	Fill	Six/One	Fill of F10
9	Fill	Six/One	Fill of F10
10	Fill	Two/Two	Fill of F7
11	Fill	Two/Two	Fill of F7
12	Fill	Two/Two	Fill of F7
13	Fill	Two/Two	Fill of F7
14	Fill	Three/Two	Fill of F8
15	N/A	N/A	N/A
16	Fill	One/One	Fill of F13
17	Fill	Four/One	Fill of F9
18	Deposit	Five/Two	F15
19	Fill	One/One	Fill of F5
20	Fill	One/One	Fill of F5
21	Fill	One/One	Fill of F5
22	Fill	One/One	Fill of F5
23	N/A	N/A	N/A
24	Fill	Six/One	Fill of F12
25	Fill	Six/One	Fill of F12
26	Fill	One/One	Fill of F6
27	Fill	One/One	Fill of F6
28	Fill	One/One	Fill of F6
29	Fill	One/One	Fill of F6
30	Fill	One/One	Fill of F6
31	Fill	One/One	Fill of F6

No.	Type	Trench/Field no.	Description
32	Fill	Three/One	Fill of F12
33	Fill	Three/One	Fill of F12
34	Fill	Two/One	Fill of F7a
35	Fill	Two/One	Fill of F7a
36	Fill	Two/One	Fill of F7a
37	Fill	One/One	Fill of F3
38	Fill	One/One	Fill of F3
39	Fill	One/One	Fill of F3
40	Fill	One/One	Fill of F3
41	Fill	One/One	Fill of F3b
42	Fill	Two/One	Fill of F7b

APPENDIX 2
LIST OF FINDS

LIST OF FINDS

Find no	Feature	Description	Material	Number
03E0679:1	Trench 3, F1, #1	Clean back	Iron Slag	1
03E0679:2	Trench 4,F1,#2	Clean back	Nail & Oyster shell	2
03E0679:3	Trench 5, F1,#3	Clean back	Modern China	1
03E0679:4	Trench 2, #4	Clean back	Ceramic & China	11
03E0679:5	F13, #5	Context 16, Fill of F13	Medieval Pottery	1
03E0679:6	F13, #6	Context 16, Fill of F13	Medieval Pottery	1

APPENDIX 3 FEATURES CATALOGUE

FEATURE LOG

No.	Type	Trench/Field no.	Description
1	Topsoil	All	Overburden
2	Subsoil	All	Subsoil
3	Cut	One/One	Hearth
4	Cut	One/One	Furrow
5	Cut	One/One	Hearth
6	Cut	One/One	Hearth
7	Cut	Two/One	Pit
8	Cut	Three/One	Iron smelting furnace
9	Cut	Four/One	Hearth
10	Cut	Six/Two	Hearth
11	Cut	Five/Two	Posthole
12	Cut	Three/One	Iron smelting furnace
13	Cut	One/One	Pit
14	Cut	Two/One	Pit
15	Cut	Five/Two	Hearth
16	Cut	One/One	Hearth.

APPENDIX 4
SLAG REPORT

**Evaluation of Archaeometallurgical Residues from the N7 Heath-Mayfield Motorway Scheme:
Site I (03E0679), Jamestown or Ballyteigeduff, Co. Laois by Dr T.P. Young**

1.0 Abstract

This report evaluates the metallurgical residues from eight sites on the N7 Heath – Mayfield Motorway Scheme. Seven of the eight sites provided evidence for iron-smelting, with a wide range of provisional dates from Iron Age to Medieval. Two of those sites also provided evidence for iron-working (smithing), as did the eighth site. The slags indicate an essentially similar iron-smelting technology across these sites and periods, employing a slag-pit shaft furnace, but subtle differences emerge and these are explored as possibly representing temporal variation in technology. The wide distribution of iron smelting sites across the landscape suggests a dispersed “industry”. The iron smelting slags have great potential for advancing understanding of these sites and of the smelting technology and should be the subject of further detailed analysis.

This report also discusses the structural evidence for metallurgical processes, including smelting furnaces and charcoal-production pits. Two sites have produced slight evidence that the Irish slag-pit shaft furnaces may have had furnace arches, as recorded for somewhat similar non-slag tapping shaft furnaces elsewhere and the primary field evidence for this should be re-examined in detail. It is tentatively suggested that both the size of smelting furnaces and the size/shape of the charcoal pits may have some temporal significance.

2.0 Background

This report is an evaluation of archaeometallurgical residues, mainly slags, from sites on the N7 Heath – Mayfield Motorway Scheme excavated by various directors for Valerie J Keeley Ltd (VJK Ltd). In addition to the evaluation of the residues, comment is also made here on the significance of the associated structures.

The archaeometallurgical residues have been evaluated by brief visual inspection and the use of a lower-powered binocular microscope. Descriptions and interpretations of material are necessarily limited by this approach.

Site information is based on copies of interim reports supplied by Valerie J Keeley Ltd.

This report should not to be taken as a final interpretation of the materials described herein, but is a brief catalogue, description and interpretation of the materials, together with an evaluation of their

potential for further post-ex investigation with recommendations for the form those investigations should take.

This report makes extensive reference to a previous report written for Valerie J Keeley Ltd summarising the evidence for the nature of early Irish iron smelting furnaces (Young 2003c) based on finds from four sites evaluated for Valerie J Keeley Ltd (Young 2003a, 2003b, 2003d). It is recommended that this report be read alongside that earlier summary report.

3.0 Jamestown or Ballyteigeduff, Site I, 03E0679

The assemblage of material from this site comprised 128g from c5 (F8) and 126g from c24 (F12). F8 and F12 were a pair of adjoining pit-like features with strong evidence for in-situ burning. The slag pieces were small (average 6.8g).

Both contexts yielded slags, which appeared like sinters, but which probably comprised small slag particles, abundant fine charcoal and ash, cemented by a mixture of flown slag and corrosion. Such materials have been recovered from contexts on other sites on this project that are interpreted as the basal pits of iron smelting furnaces. In addition the assemblages both contained dense prilly slags, in some cases enclosing charcoal fragments, which are also indicative of an origin in such an iron-smelting furnace.

3.1 Interpretation

Given the small size of the assemblages and of the pieces comprising them, it is very likely that they are essentially in-situ, and the features should be interpreted as the remains of iron smelting furnaces.

3.2 Discussion

Although the slag assemblage from this site was extremely limited, it clearly demonstrates that iron smelting was undertaken. The excavations revealed many other burnt features on the site, and it is to be hoped that examination for micro-residues in soil samples might reveal whether more of these were associated with metalworking, and indeed whether there is any evidence to link the metalworking with the only dated feature on site, a medieval pit.

4.0 Summary

The sites on the N7 Heath – Mayfield Motorway Scheme add significantly to knowledge of iron-making in central Ireland. The full significance of the new data will only be fully realised once the sites involved are more securely dated.

4.1 Smelting Technology

All eight smelting sites (03E0151: Ballydavis Site 1; 03E0966: Ballydavis, Site B; 03E0461: Morrett, Site D; 03E0603: Cappakeel, Site F West; 03E0633: Cappakeel, Site F East; 03E0679: Jamestown or Ballyteigeduff, Site I; 03E0635: Kill, Site O, 03E0602: Lughil, Site L) excavated along the N7 Heath – Mayfield Motorway Scheme employed essentially similar furnaces, which fall within the category of non-slag tapping furnaces commonly known as slag-pit furnaces. The terminology and typology of these furnaces is muddled and obscured by local usage (see discussion in Pleiner, 2000), but a widespread use of this spectrum of furnace types seems to have occurred across Europe in the first millennium BC. However, it is clear that these slag-pit furnaces have given rise to many local interpretations of bowl furnaces, mainly because of poor- or non-preservation of evidence for superstructure. The persistent myth of bowl furnaces for smelting in Ireland has been attacked by Crew & Rehren (2002) and Young (2003c). These Irish furnaces are actually a type of shaft furnace, as so elegantly demonstrated by Crew for Iron Age examples from North Wales (1987, 1989, 1991) and argued for several Irish examples by Young (2003c).

The sites excavated change little in the basic understanding of the operation of the slag-pit smelting furnace as previously described (Young 2003c), but do add several significant details.

4.2 Furnace morphology

Finds of intensely vitrified furnace wall material (particularly those from Cappakeel Site F West, 03E0603; c291) indicate the existence of a substantial clay superstructure to the furnaces as previously proposed.

One of the most significant differences suggested by Young (2003c) between the non-slag tapping furnaces of the Iron Age of North Wales, studied by Crew, and the examples merging in Ireland, was the absence of evidence for a furnace arch in the Irish examples. The present study includes two examples which may provide evidence for such an arch in the Irish furnaces:

1. At Morrett Site D (03E0461), it is possible that c324 is a working hollow associated with furnace c172 rather than being a separate hearth/furnace. c324 is a shallow (0.02m feature) described as being 0.9m in diameter, but shown on the supplied plan as a pear-shaped feature, approximately 0.9m wide distally, narrowing to 0.3m near to c172, with a length of 1.3m. The contact between c324 and c172 was clearly difficult to interpret as two different accounts of their stratigraphic relationship were given. C324 is described as a pit, and does not appear to have evidence for in-situ burning, unlike c172.

2. A similar situation may exist with c341 and c345 at Cappakeel Site F West which are linked by a channel (c347). No plan was provided of these features, but the narrative in the interim report states

“feature [341] was sub-circular in plan with a maximum diameter of 0.5m and it was excavated to maximum depth of 0.13m”...“this feature did not exhibit signs of in-situ burning”; “feature [345] was sub-circular in plan with a maximum diameter of 0.35m and a maximum depth of 0.09m”...“subsoil in the immediate area surrounding the cut was oxidised to a reddish orange colour indicating probable burning in-situ. The features [341] and [345] were linked by the shallow cut [347] which was a maximum of 0.3m long and 0.22m wide and was excavated to a maximum depth of 0.1m”.

Crew's (1991) reconstruction of the North Welsh furnaces includes an arch 0.10-0.13 wide through the 0.20m thick furnace wall, with the floor of the channel in the arch sloping down into the furnace. It is possible that in the examples from this project, Morrett Site D(03E0461) c172 and Cappakeel Site F West (03E0603) c345 are the bases of smelting furnaces, outside which are working hollows (c324 and c341 respectively), into which slag could be raked, and access to the furnace gained, through an arch, the position of the floor of which is represented by the narrow elongation of c324 and channel c347 respectively.

The new data from the N7 Heath – Mayfield Motorway Scheme certainly does not prove the existence of arches in the Irish furnaces, but does provide some circumstantial evidence, which should mean that presence/absence of such evidence in future excavations should be actively sought.

The recorded diameter of the furnace pits is highly variable between, and within, sites. Although, as noted above, it is possible that part of this variation may be variations in the way furnaces are dug (whether excavators over dig and remove baked natural...) and in the way they are built (whether the internal furnace lining is carried down to line the pit, as described by Crew (1987), particularly in unconsolidated subsoils), there appears to be genuine variation in the volume of the slag pit. Some sites, such as Ballydavis Site B (03E0966) of this project and Celbridge 5 (Young 2003b) have small furnaces with diameters of 0.30m, whereas the largest furnaces (such as Morrett Site D, 03E0461, Jamestown or Ballyteigeduff Site I, 03E0679 and Tullyallen 6 (Young 2003d)) have diameters of approximately 0.50m or slightly more. There is reasonable expectation that the Ballydavis B (03E0966) furnaces are Iron Age, whereas some of the larger furnaces are interpreted as being medieval, but whether there is a general trend in the size of furnaces will not be revealed until all these sites are properly dated by C14.

Site	Feature	Diameter	Depth
N7 Heath - Mayfield			
Ballydavis, Site 1,	c1031	no dimensions given	

03E0151

c1062	no dimensions given
c298	no dimensions given
c257	no dimensions given

Ballydavis, Site B,

03E0966	c15	0.34	0.20
	c17	0.28	0.10
		0.31	

Morrett, Site D, 03E0461	c172	0.6	0.18
	c140	0.37	0.19
	c141	0.56	0.28
	c142	0.67	0.18
		0.55	

Cappakeel, Site F (west),

03E0603	c239	0.36	0.21
	c240	0.45	0.25
	c299	0.41	0.25
	c334	0.34	0.11
	c342	0.26	0.22
	c345	0.35	0.09
		0.36	

Jamestown or
 Ballyteigeduff, Site I,

03E0679	F8	0.55x0.60	0.20
	F12	0.70x0.45	0.10

Lughill, Site L, 03E0602	F7	no dimensions given
	F22	no dimensions given
	F18	no dimensions given

After Young 2003c

Celbridge 5			
01E0306	furnace 1	0.29	0.25
	furnace 2	0.29	0.16
	furnace 3	0.29	0.26
Carrickmines Great			
02E0272		0.37	0.09
Tullyallen 6			
00E0944		0.5	0.18

Table 3. Comparison of smelting furnace dimensions with previous examples. Figures in grey boxes are site average.

In parallel with the apparent variation in furnace size, there is a variation in the morphology of the slags retrieved from the basal deposits of the furnaces (the Type 1 assemblages, see below). In general, a comparison of the data in Tables 3 and 4, suggests that those assemblages from the smaller furnaces contain the smaller particle size of slag. This relationship is borne out in a simple way by the larger size of prills and basal flows from Morrett compared with material from Ballydavis or Cappakeel. This adds further circumstantial evidence for a genuine difference in the scale of process between sites.

4.3 Residue assemblage types

One interesting aspect of the smelting residue assemblages is that there appear to be a limited number of styles (composition and preservation) of assemblages. There are three broad categories of smelting slag assemblage recognised in this material:

1. dominantly (average usually less than 10g) small pieces of slag in various morphologies:
 - slag spheroids of 4-8mm diameter
 - sintery-appearing fine slags, with ash, charcoal debris and admixed sediment.
 - vertically descending prills
 - stalagmitic slag accumulations formed on the furnace floor beneath persistent slag drips
 - small cross-floor flows
2. large blocks of coalesced prilly slags with abundant charcoal inclusions, often rather friable. The proximal (blowing wall) side may show development of one or more burrs, down-wall flow, and

accumulation of stacked flow lobes at the wall foot. Massive slags developing near the wall foot may enclose large moulds of wood/charcoal often of sizes up to 40x60x200mm. These massive slags may grade laterally into cross-floor flow lobes. These slags blocks may be termed "furnace bottoms".

3. Fragments derived from the more massive, less friable parts of the "furnace bottoms" described above, particularly the dense slags associated with the blowing wall (burr, down-wall flows, stacked flow lobes, massive slags with very large wood/charcoal inclusions). Typically these assemblages also include large blocks of vitrified furnace lining.

During normal operation of the smelting furnace the basal pit would be cleared of slag after each smelt. The more distal parts of the "furnace bottom" are rather friable and would be likely to become very degraded during extraction and disposal. The dense slags associated with the proximal side of the furnace will become broken-up during extraction, but are physically strong and have a much higher preservation potential. Disposal of this material, together with disposal of material created during repair of the superstructure would create a Type 3 assemblage.

The very basal part of the furnace would accumulate deposits of ash and unburnt fuel fragments, but would also contain the fine residues described as Type 1 above. If the basal part of the furnace was thoroughly cleaned then these would need disposal, but this might be undertaken separately from the large blocks of "furnace bottom" which could be carried by hand. If the furnace was not thoroughly cleaned, then some of this material might accumulate in the basal pit, giving rise to the apparently in-situ deposits recorded from most smelting furnaces recorded on sites in this study (Ballydavis 2, Site A 03E0151; Ballydavis, Site B 03E0966; Morrett, Site D 03E0461; Cappakeel Site F West 03E0603; Jamestown or Ballyteigeduff, Site I 03E0679; Lughill, Site L 03E0602).

Type 2 assemblages, in which the furnace bottom is intact or largely so, have only been recorded so far in instances where the furnace bottom has been left in-situ, and not cleared from the furnace. In this study only furnace c141 at Morrett, Site D (03E0461), yielded a substantial part of a "furnace bottom" (approximately 5.6kg). But even here the denser, stronger, parts of the FB seemed to have been extracted. In this instance the finds of Type 1 from above the partial FB hint that it may have been left in the furnace base of an operational furnace. In contrast, the FB encountered at Tullyallen 6, Co. Louth (Young 2003c, 2003d) appears to have survived intact; presumably the furnace was simply abandoned after that smelt.

Site/context	Weight	No of pieces	Average weight	Assemblage type
Cappakeel West, Site F				
Furnace 239	532	70	7.6	1
Furnace 240	1562	71	22.0	1
Furnace 299	262	43	6.1	1
Furnace 334	2747	260	10.6	1
Furnace 342	2	1	2.0	1
Pit 268	19238	177	108.7	3
Morrett, Site D				
Furnace 140	1544	165	9.4	1
Furnace 141	6307	380	16.6	2 & 1
Furnace 172	1090	29	37.6	3
Pit? 324	1015	31	32.7	3
Furnace 142	2155	9	239.4	3
Spread 335	5561	84	66.2	3
Ballydavis 2, Site A				
1056	604	>242	<2.5	1

Table 4. Comparison of average fragment weight and assemblage type for residues recovered from smelting furnaces.

4.4 Charcoal Production

A close association between the location of iron smelting furnaces and of charcoal production pits has been noted for several sites, particularly Cappakeel and Morrett.

The charcoal production pits at Morrett may be distinguished from those of the other three sites on the basis of both dimensions and shape (Table 5 and Figure 1). The main body of pits from Ballydavis and Cappakeel forms a trend from small pits (L from 1.2 to 1.4m) with relatively equant shapes (L/I of 1.2 to 1.3) through to large (L from 3 to 3.5m) and elongate shape (L/I of 2.1 to 2.3). These pits are almost all rectangular with rounded corners.

Site	Context	L	l	d	L/l
Ballydavis B	12	1.30	1.10	0.10	1.2
Cappakeel East	82	2.40	1.60	0.41	1.5
	95	1.90	1.10	0.08	1.7
	5	1.80	0.80	0.07	2.3
	93	1.17	0.86	0.08	1.4
	296	1.34	1.08	0.15	1.2
Cappakeel West	267	1.25	0.95	1.00	1.3
	60	1.30	0.75	0.22	1.7
	115	1.35	0.83	0.25	1.6
	220	1.25	0.70	0.33	1.8
	205	2.30	1.39	0.40	1.7
	207	3.05	1.30	0.22	2.3
	234	1.45	1.09	0.39	1.3
	16	3.23	1.55	0.19	2.1
Morrett Site D	126	1.80	1.60	0.53	1.1
	37	1.90	1.60	0.45	1.2

Table 5. Long axes (L), short axes (l) and depths (d) recorded for charcoal production pits.

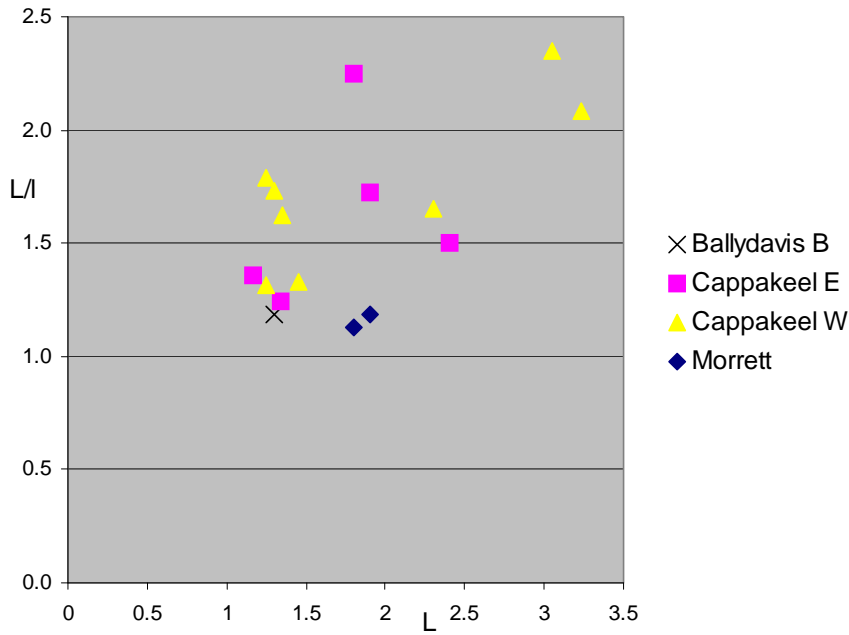

Figure 1. Graph of the ratio of the long to short axis of charcoal pits, plotted against the long axis dimension.

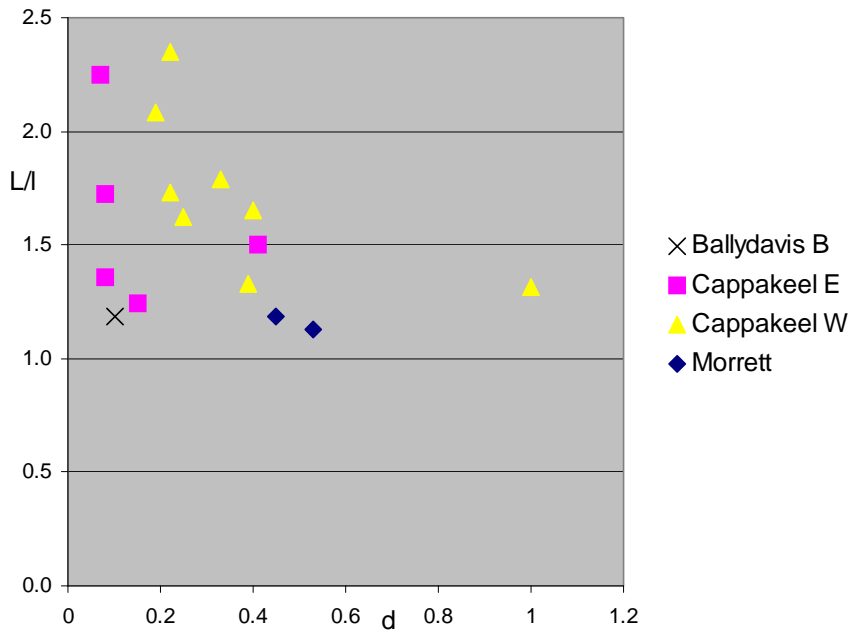

Figure 2. Graph of the ratio of the long to short axis of charcoal pits, plotted against their depth.

Cappakeel forms a trend from small pits (L from 1.2 to 1.4m) with relatively equant shapes (L/I of 1.2 to 1.3) through to large (L from 3 to 3.5m) and elongate shape (L/I of 2.1 to 2.3). These pits are almost all rectangular with rounded corners.

In contrast the pits at Morrett Site D are much more irregular in shape, more equant (L/I of 1.1 to 1.2) and medium sized (L of 1.8 to 1.9m).

The graph of the long/short axis ratio against the depth of the pits (Figure 2) also shows a segregation (with some overlap) between sites. Ballydavis B and Cappakeel Site F East show depths (with a single outlier) of 0.07 to 0.15m, Cappakeel Site F West (with one outlier) shows depths of 0.19 to 0.40m and Morrett Site D has depths of 0.45 to 0.53m. There is some suggestion that the more equant pits on each site are deeper.

These data for charcoal pit morphology should be compared with data from other comparable sites. They appear to emphasise that Morrett is slightly different in character from the Cappakeel and Ballydavis sites; a feature also noted in the characteristics of the iron smelting. It remains to be seen whether this has significance in terms of age of the site.

4.5 Smithing

This project produced surprisingly little residue from iron-working. Out of a total collection of some 54kg of slag from eight sites, only 7kg was attributable to smithing.

A small amount of material (approximately 1kg), presumably Iron Age in date, came from Ballydavis Site 1, (03E0151). This material is rather fragmentary, but includes one piece of probable SHC weighing 484g, suggesting the presence of a cake size which might possibly be attributable to bloomsmithing in the Iron Age (Crew & Rehren 2002).

Cappakeel Site F East (03E0633), produced a small amount of smithing debris (approximately 4kg) from a ditch which is likely to be earlier Medieval in date. The fragmentary SHCs included some material indicative of large examples (greater than 3kg), which seem likely to be indicative of bloomsmithing on early medieval sites.

Kill Site O (03E0635), produced just under 2kg of smithing slag from a ditch, which also seems likely to be Medieval. This material was very fragmentary, but appeared to contain a spread of SHC size, ranging up from a small 290g example (presumably from blacksmithing), up to small pieces of much larger cakes (possibly from bloomsmithing).

4.6 Organisation of the industry

The archaeometallurgical assemblages from this project are unusual. A large number of iron smelting furnaces were located, but in most cases these only contained a small assemblage of smaller slag

pieces which had escaped the cleaning of the furnace. In some cases dumps of coarse slag material from the main “furnace bottoms” were found, within abandoned furnaces or other features. However, it is clear that the main slag output of the located furnaces was not seen.

In a British Iron Age example of a similar smelting technology in East Yorkshire, large dumps of “furnace bottoms” survived as mounded landscape features (Halkon 1997). It is possible that a similar mode of disposal occurred with these sites, and subsequent agricultural activity has either degraded the mounds, or they became cleared into the field boundaries.

Equally striking is the relative lack of evidence for the working of the blooms produced in the furnaces. It is apparent that those locations where iron-working slags were retrieved are features associated with settlements (including the “ceremonial” enclosure at Ballydavis Site 1 and the Medieval boundary/defensive ditches at Cappakeel Site F East and Kill Site O).

Such a differentiation between dispersed smelting and focused bloomsmithing/smithing is a frequent feature of early iron making in the British Isles. It becomes strongly enhanced in the later medieval period when the bloomsmithy often became water-powered, but this functional differentiation is also seen earlier. In part it may have its origins in the large quantities of charcoal required for smelting. The smelting furnace tended to be a clay-built ephemeral structure, so it was relatively straightforward to locate the smelting activity at the point of manufacture of the charcoal. Such ephemeral smelting, following the coppicing or even clear-felling of timber has been described for Coed y brenin, North Wales, for the fourteenth century (Smith 1995). It may lie behind the use of the term “fabricam arrantem” in the thirteenth century in the Forest of Dean.

5.0 Assessment of Potential

The material described in this report has great potential for both increasing the understanding of the individual sites and as an enormous contribution to Irish archaeometallurgy.

The post-ex investigative programme should try to address the unresolved questions raised in this report concerning some of local details of stratigraphy and furnace morphology, establishing for instance the size of the true furnace pit, and examining further the primary field evidence for the presence of a furnace arch.

Detailed compositional studies of the smelting slags should be undertaken to improve understanding of the technology of the slag-pit furnaces and their yield. The examples of iron smelting all derive from fairly small area (16km separates Ballydavis, Site 1 (03E0151) and Kill Site O (03E0635)) and are

therefore likely to be exploiting very similar resources of bog iron ore (Co. Laois has outcrops of rock ores, but these are some distance from the sites in question). They thus may well form a suitable database on which to model chemical composition and mass balance, in order to determine iron yields (following the approach of Thomas and Young, 1999a and 1999b). Production of mass balance models for the various sites will require a substantial number of chemical analyses from as many different slag types within each site as possible. Understanding mass balance variation between sites will help to illuminate changing technology through time. Although the fundamental technology of the smelting furnace appears not to vary greatly between sites, it appears that the scale of each smelt did vary, based on variations of the slag-pit diameter and of the size of slag prills and flows found within them.

The residues from iron-working encountered in this project are rather less significant, and are less likely to add further to present understanding.

One key factor in the potential of this material is the spread of likely dates for the assemblages. It is absolutely crucial therefore, that before publication all the metallurgical data should be reviewed in the light of C14 dating results.

6.0 References

CLOGG, P. 1999. The Welham Bridge Slag. pp 81-96 In P. Halkon and M. Millett, Rural settlement and Industry: Studies in the Iron Age and Roman Archaeology of Lowland East Yorkshire. Yorkshire Archaeological Society.

CREW, P. 1987. Bryn y Castell Hillfort – a Late Prehistoric Iron Working settlement in north-west Wales. In: SCOTT, B.G. & CLEERE, H. (eds) The Crafts of the Blacksmith. 91-100.

CREW, P. 1989. Crawcwellt West excavations 1986-1989. A late prehistoric ironworking settlement. Archaeology in Wales, 29, 11-16.

CREW, P. 1991. The Experimental Production of Prehistoric Bar Iron, Historical Metallurgy, 25, 21-36

CREW, P. 1995. Bloomery iron smelting, slags and other residues. Historical Metallurgy Society, Archaeology Datasheet No. 5.

CREW, P. 1996. Bloom refining and smithing, slags and other residues. Historical Metallurgy Society, Archaeology Datasheet No. 6.

- CREW, P. 1998. Excavations at Crawcwellt West, Merioneth, 1990-98: A late prehistoric upland iron-working settlement. *Archaeology in Wales*, 38, 22-35.
- CREW, P. & REHREN, T. 2002. Appendix 1: High-temperature workshop residues from Tara: iron, bronze and glass. Pp. 83-102 In: ROCHE, H. Excavations at Ráith na Ríg, Tara, Co. Meath, 1997. *Discovery Programme Reports*, 6, 19-165.
- HALKON, P. 1997. Fieldwork on early iron working sites in East Yorkshire. *Historical Metallurgy*, 31, 12-16
- PLEINER, R. 2000. *Iron in Archaeology: The European bloomery smelters*, Prague.
- SCOTT, B.G. 1990. *Early Irish Ironworking*. Ulster Museum Publication 266, Belfast, 238pp.
- SMITH, K. 1995. Iron-working in North-West Wales in the Late Fourteenth Century. *Archaeological Journal*, 152, 246-290.
- THOMAS, G.R. & YOUNG, T.P. 1999a. A graphical method to determine furnace efficiency and lining contribution to Romano-British bloomery iron-making slags (Bristol Channel Orefield, UK). In: YOUNG, S.M.M., BUDD, P.D., IXER, R.A. and POLLARD, A.M. (eds). *Metals in Antiquity*, British Archaeological Reports International Series, 792, 223-226. Archaeopress, Oxford.
- THOMAS G.R. & YOUNG, T.P. 1999b. Bloomery furnace mass balance and efficiency. In: POLLARD, A.M. (ed) *Geoarchaeology: exploration, environments, resources*, Geological Society of London, Special Publication, 165, 155-164.
- TYLECOTE, R.F. 1986. *The Prehistory of Metallurgy in the British Isles*. The Institute of Metals. 257pp.
- YOUNG, T.P. 2003a. Evaluation of slag from the SE Motorway, Co. Dublin (02E0428, 02E0272, 02E0074 and 02E0076). *Geoarch Report 2003/02*. 3pp.
- YOUNG, T.P. 2003b. Evaluation of slag from Celbridge Site 5, County Kildare (01E0306). *Geoarch Report 2003/07*. 5pp.

YOUNG, T.P. 2003c. Is the Irish iron-smelting bowl furnace a myth? A discussion of new evidence for Irish bloomery iron making. Geotech Report 2003/09. 4pp.

YOUNG, T.P. 2003d. Evaluation of slag from Tullyallen 6, Co. Louth (00E00944). Geotech Report 2003/10. 2pp. + 2 figs.

YOUNG, T.P. 2005. Metallurgical Residues from Clonmacnoise, Part 1: Evaluation of material from the waste water treatment works (02E1407). GeoArch Report 2005/06. 29pp.

Appendix 1: Catalogue of material by context and bag

Site: Jamestown or Ballyteigeduff,
 Site I, 03E0679
 Director: Patricia Lynch

Summary

context	sample	find	find note	total wt	description	Deposit
5	14		F8	128	Sparse smelting assemblage – see below	Hearth
24	23		F12	126	Sparse smelting assemblage – see below	Hearth
				254 total (g)		

Details

context	find	No. of pieces	weight	description
5		4	24	Pieces of dense prill
		1	6	Irregular vesicular slag bleb
		1	20	Very small dense slag fragment
		1	54	Bleb with attached sintery rough material, rather amorphous
		6	24	Sintery material. Rough looking but actually mainly a rather granular slag with adhering charcoal etc.
				128 total (g)
24		15	46	Finely organic-rich sintery slag – but actually this does not look to be a true sinter – it is fine slag with lots of fine scale charcoal
		1	24	Amorphous dense slag rub

8 56 Prilly slag belbs surrounding charcoal fragments
126 total (g) Fines checked for scale but none found

APPENDIX 5
POTTERY REPORT

**Post Medieval Pottery Report N7 Heath Mayfield Motorway Scheme, Co. Laois. Incorporating:
Site G; Ballyshaneduff or The Derries Townland 03E0662, Site I; Jamestown or Ballyteigeduff
Townland 03E0679 and Site E; Morett Townland 03E0804 by Patrick Hall BSc. BA (Hons.)**

1.0 Introduction

A total of 16 ceramic finds were presented for analysis from 3 different resolved sites. Two of the sites, 03E0662 & 03E0804, comprised of fulacht fiadh and associated features. These yielded mainly post medieval modern pottery from the 17th-19th Centuries; with two pieces of late medieval / early post medieval period 15th/16thC. The third site, Site I, 03E0679 comprised hearths, pit, postholes, area of burning & a modern furrow. This yielded 2 pieces of medieval sherds from the fill of F13; Feature (13) was the largest feature in Trench 1, and measured 2.96cms in length, 252cms in width and 0.3m in depth. The feature contained a single layer, Context (16) that consisted of a loose, sandy grey fill with the occasional inclusion of charcoal. Medieval pottery, (Find no. 03E0679:5 & Find no. 03E0679:6) were recovered from within the context. One piece of late medieval / early post medieval 15th / 16thC; 2 pieces of 18th/19thC modern and 2 pieces of building material were found during the clean back.

2.0 Methodology

The sherds have been identified visually, with the aid of a 10X magnification microscope. This information is presented in Table 1.

Composition and condition of assemblage

The assemblage is fragmented with only a small portion of each vessel remaining. No joining sherds were identified and no reconstruction possible. Many sherds in the assemblage are abraded having been recovered from: ploughsoil & upper deposit of fulacht fiadh; 5No. post med. (37.5%) 1No. medieval (6.25%); clean back or natural deposit: 4No. post med. (25%), 2No. building material (12.5%), 1No. late med. /early post med. (6.25%) Total (87.5%).

12.5% of the material is Medieval in date. Dublin Glazed Ware: Fabric 002/ Dublin Hand-Built Ware: Fabric 004 or local imitation. Evidence from excavation elsewhere would suggest a date in the late 12th -13th centuries for Fabric 004 (McMahon 2002, 97; Papazian 2000, 114) while it is thought that Fabric 002 is later, dating to the early 13th century perhaps continuing into the 16th century (Papazian 2000, 115).

Post-medieval sherds, 43.75%, comprising Industrial Slipcast Ware, Creamware, Brownware or Dairyware, Brown Pattern Transfer Ware and Slipcast China from Tea/Dinner services were also recovered.

3.0 Medieval Pottery

Dublin Glazed Ware: Fabric 002/ Dublin Hand-Built Ware: Fabric 004

The sherds in this group are orange-grey in colour, usually with orange outer surfaces and grey cores, although fully oxidised examples also exist. The sherds are well tempered with small (<1mm) inclusions, including quartz and mica. The exterior surfaces are inconsistently 'splash' glazed to a green colour, using a copper and lead preparation, with some having no glaze, others partially glazed and some examples well covered. The fabric compares well with that known as Dublin Glazed Ware: Fabric 002 as well as Dublin Hand-Built Ware: Fabric 004. Differentiation between these two fabrics relies largely on analysis of construction, typology and decoration (Papazian 1989, 175). The fragmented and abraded nature of the material from Heath Mayfield has meant that this has not been possible.

Find #	Context#	Area	Description	Weight	Fits with#	Weight Totals
Site G ; Ballyshaneduff or The Derries Townland 03E0662						
Not Given	144: Dark wash from mound B	Site G	Earthenware, quartz and feldspar inclusions, light orange fabric, hand thrown base sherd with lead/iron glaze to inside, remnant of handle at base indicative of original usage as jug. Carbon deposit on external surface suggests kitchenware use for cooking. Locally produced. Late Medieval/early post Med 15 th /16 th C. 7.50x4.00x2.00cm	31.9g		
2-5 No specific #	1: Ploughsoil /sod layer	Site G	White earthenware Industrial slipware, transparent glaze, body sherd, post Med. English 18 th /19 th C 5.00x4.00x0.80cm	20.3g		
2-5 No specific #	1: Ploughsoil /sod layer	Site G	Slipcast earthenware with china clay base sherd, Creamware saucer/side plate, brown transfer type décor to one side, transparent lead glaze both sides. English 18 th /19 th C 3.00x3.00x0.30cm	4.8g		
2-5 No specific #	1: Ploughsoil /sod layer	Site G	Creamware, slipcast earthenware with china clay rim sherd, hand banded brown rim décor with hand painted orange & brown feathered type décor to outside, probably from teacup or similar, transparent lead glaze both sides. English 18 th /19 th C 2.20x1.20x0.30cm	1.5g		
2-5 No specific #	1: Ploughsoil /sod layer	Site G	Brownware, temper free red earthenware body sherd, oxidised orange fabric, thrown, quartz and silica inclusions. Lead/iron brown glaze both sides, probably locally produced 18 th /19 th C 4.70x2.60x0.30cm	6.00g		
6-8 No specific #	3: Upper deposit, fulacht A; F1	Site G	Brownware, Temper free red earthenware rim sherd with ribbed detail, oxidised orange fabric, thrown, quartz and silica inclusions. Iron/lead brown/black glaze inside and outside, Lancashire/N Wales or locally produced Dairyware 17 th /18 th C 4.30x3.50x0.70cm	14.3g		
6-8 No specific #	3: Upper deposit, fulacht A; F1	Site G	Earthenware, quartz and feldspar inclusions, temper free, light orange fabric, hand thrown body sherd with lead/iron glaze to inside and spots outside, Locally produced. Late Medieval/early post Med 15 th /16 th C. 5.00x3.40x0.50cm	8.0g		

Find #	Context#	Area	Description	Weight	Fits with#	Weight Totals
			Site G's 7 No. pottery finds. Weighing 86.6g in total.			
Site I ; Jamestown or Ballyteigeduff Townland 03E0679						
03E0679:3	Clean back	Site I	Slipcast, vitrified white stoneware fabric, body sherd, probably from dinner ware item, clear transparent glaze, English 18 th /19 th C 3.20x3.20x0.20cm	4.0g		
03E0679:4a	Clean back	Site I	Earthenware base sherd, quartz & feldspar inclusions, highly abraded oxidised light orange fabric, wheel thrown, occasional voids left by burnt out organic matter. Iron/copper/lead green/brown glaze inside, specks transparent other side probably locally produced late medieval/early post Med. 15 th /16 th C 4.40x3.00x0.60cm	8.3g		
03E0679:4b	Clean back	Site I	Highly abraded white earthenware sherd, sliver of modern china pottery with white glaze to both sides, probably English 18 th /19 th C 2.10x1.70x0.10cm	0.5g		
03E0679:4c	Clean back	Site I	Earthenware fired clay brick or architectural detail fragment, abraded, partially oxidised orange/tan fabric, no glaze, quartz, feldspar & iron inclusions. 3.00x2.20x1.40cm	3.7g		
03E0679:4d	Clean back	Site I	Earthenware fired clay brick or architectural detail fragment, partially oxidised orange/tan fabric, no glaze fired >1000C quartz, feldspar & iron inclusions 1.60x1.30x1.00cm	1.6g		

Find #	Context#	Area	Description	Weight	Fits with#	Weight Totals
03E0679:5	16: Fill of F13	Site I	Earthenware rim sherd, mica, quartz, and feldspar inclusions green, lead/copper glaze splashed to outside only, spots of glaze inside. Abraded orange oxidised grey core fabric with incised line decor. Probably from a pot but possibly from pulled strap handle. Evidence from excavation elsewhere would suggest a date in the late 12th -13th centuries for Fabric 004 (McMahon 2002, 97; Papazian 2000, 114) while it is thought that Fabric 002 is later, dating to the early 13th century perhaps continuing into the 16th century (Papazian 2000, 115). Dublin Glazed Ware: Fabric 002/ Dublin Hand-Built Ware: Fabric 004 or local imitation. 3.70x3.60x0.90cm	10.1g		
03E0679:6	16: Fill of F13	Site I	Earthenware body sherd, mica, quartz, and feldspar inclusions green, lead/copper to outside only. Abraded orange oxidised fabric. Evidence from excavation elsewhere would suggest a date in the late 12th -13th centuries for Fabric 004 (McMahon 2002, 97; Papazian 2000, 114) while it is thought that Fabric 002 is later, dating to the early 13th century perhaps continuing into the 16th century (Papazian 2000, 115). Dublin Glazed Ware: Fabric 002/ Dublin Hand-Built Ware: Fabric 004 or local imitation. 2.00x1.70x0.70cm	0.9g		
			Site I's 7 No. pottery finds. Weighing 29.1g in total.			29.1g
Site E ; Morett Townland 03E0804						
1	3: natural deposit.	Site E	Brownware, Temper free red earthenware abraded body sherd, oxidised orange fabric, thrown, quartz and silica inclusions. Iron/lead brown/black glaze inside, Lancashire/N Wales or locally produced Dairyware 17th/18thC 2.30x2.10x0.50cm	3.1g		
2	3: natural deposit.	Site E	Red earthenware oxidised orange fabric rim sherd. Lead/copper green glaze to inside, locally produced 17 th /18 th C 5.00x3.50x1.20cm .	16.9g		
			Site E's 2 No. pottery finds. Weighing 20.0g in total.			20.0g

4.0 Bibliography:

Papazian, C. (1989) *The Medieval Pottery from Dublin Castle Excavations*. MA Thesis, NUI.

Papazian, C. (1997) 'Medieval and Later Pottery from Site G', in *Archaeological Excavations at Patrick, Nicholas and Winetavern Streets, Dublin*, Walsh, C., Dublin, 124-128.

Papazian, C. (2000) 'The Medieval Pottery', in *The Port of Medieval Dublin. Archaeological Excavations at the Civic Offices, Winetavern Street, Dublin 1993*, Halpin, A., Dublin, 103-117.

APPENDIX 6
CLAY PIPE REPORT

1.0 Results

Project: N7 Heath Mayfield Motorway Scheme

Site Name: Jamestown or Ballyteigeduff: Site I

Ex. No.: 03E0679

Director: Patricia Lynch

Find no. 4, Context -

Part of pipe bowl and stem junction, not enough remains to be certain of a date.

APPENDIX 7
SITE MATRIX

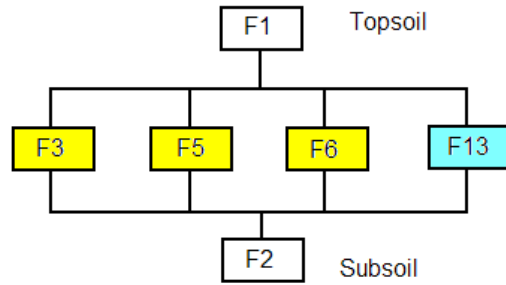

 : Hearth

 : Pit

Trench 1

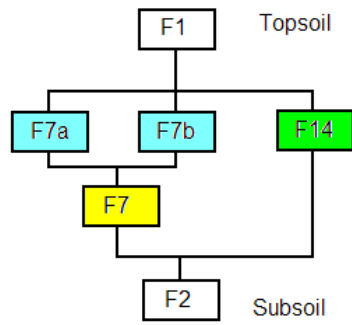



 : Non Archaeological

 : Hearth

 : Pit

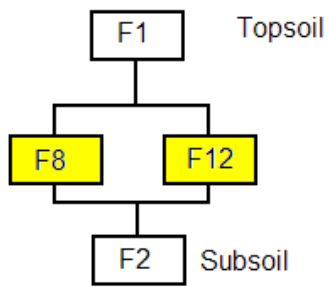
Trench 2



 : Iron smelting furnace

Trench 3

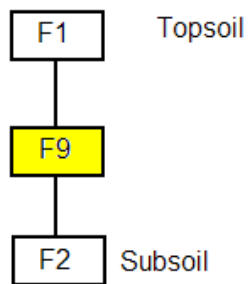

 : Hearth

Trench 4

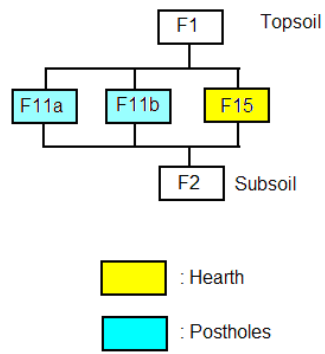

Trench 5

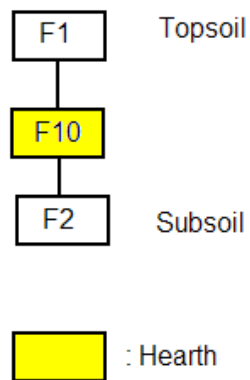

Trench 6

Plates



Plate 1: Section of Feature 3, from south



Plate 2: Section of Feature 5, from east



Plate 3: Post - excavation of Feature 7, from northeast



Plate 4: Post - excavation of Feature 12 (left) and Feature 8, from northeast



Plate 5: Section of Feature 9, from north



Plate 6: Section of Feature 10, from west



Plate 7: Post - excavation of Feature 11, from north



Plate 8: Section of Feature 13, from west

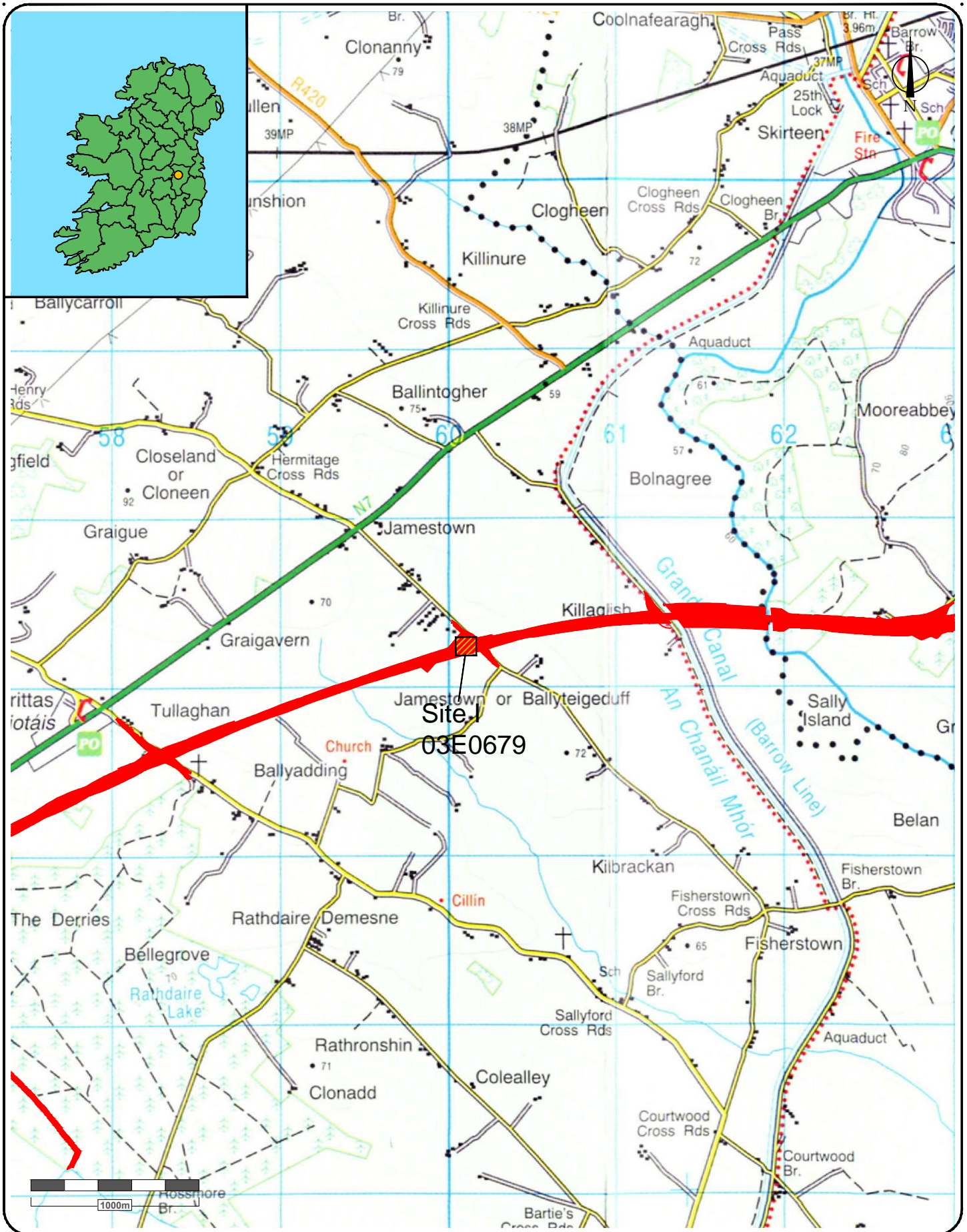

Title Location of 03E0679 Site I on Ordnance Survey Discovery Map, sheet 55 extract		Notes				Brehon House Kilkenny Road Castlecomer Co. Kilkenny.	Tel: (+353) 056 4440236 Fax: (+353) 056 4440237 Email: vjk@vjk.ie Website: www.vjk.ie
Client Kildare County Council	Job No. 03E0679	Drawn by GW	CAD reference 1047-03-400/Tera3	Date January 12	Scale 1:30000	Drawing No. Figure 1	Project N7 Heath-Mayfield Motorway Scheme

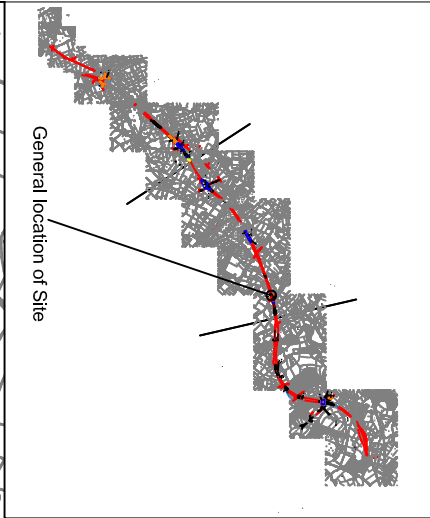

Title		Notes	
Location of 03E0679 Site 1 on N7 Heath-Mayfield Motorway Scheme			
Job/Exc No.	Completed by	CAD reference	Client
03E0679	GW	1047-03-400/Tera3	Kildare County Council
Date	Scale	Drawing No.	Project
January 12	1:20000	Figure 2	N7 Heath-Mayfield Motorway Scheme
Brehon House Kilkenny Road Castlecorner Co. Kilkenny.		Tel: (+353) 056 4440236 Fax: (+353) 056 4440237 Email: vk@vk.ie Website: www.vk.ie	

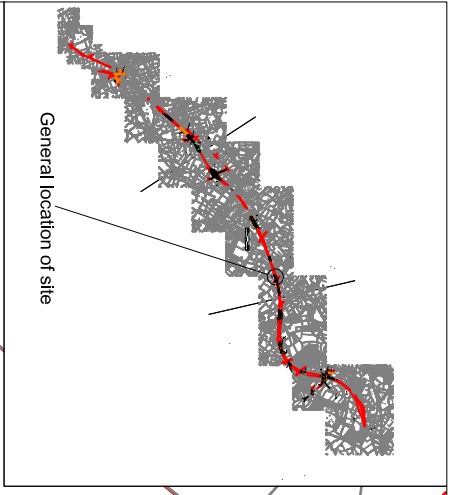

Title		Notes		Client	
Trench Layout Site I				Kildare County Council	
Job/Exc No.		Completed by		Project	
03E0679		DE		N7 Health-Mayfield Motorway Scheme	
Date		CAD reference		Architectural Consultancy	
January 12		1047-03-400/Tera3		 Brethon House Kilkenny Road Castlecorner Co. Kilkenny.	
Scale		Drawing No.		Contact	
1:1100		Figure 3		Tel: (+353) 056 4440236 Fax: (+353) 056 4440237 Email: vk@vk.ie Website: www.vk.ie	

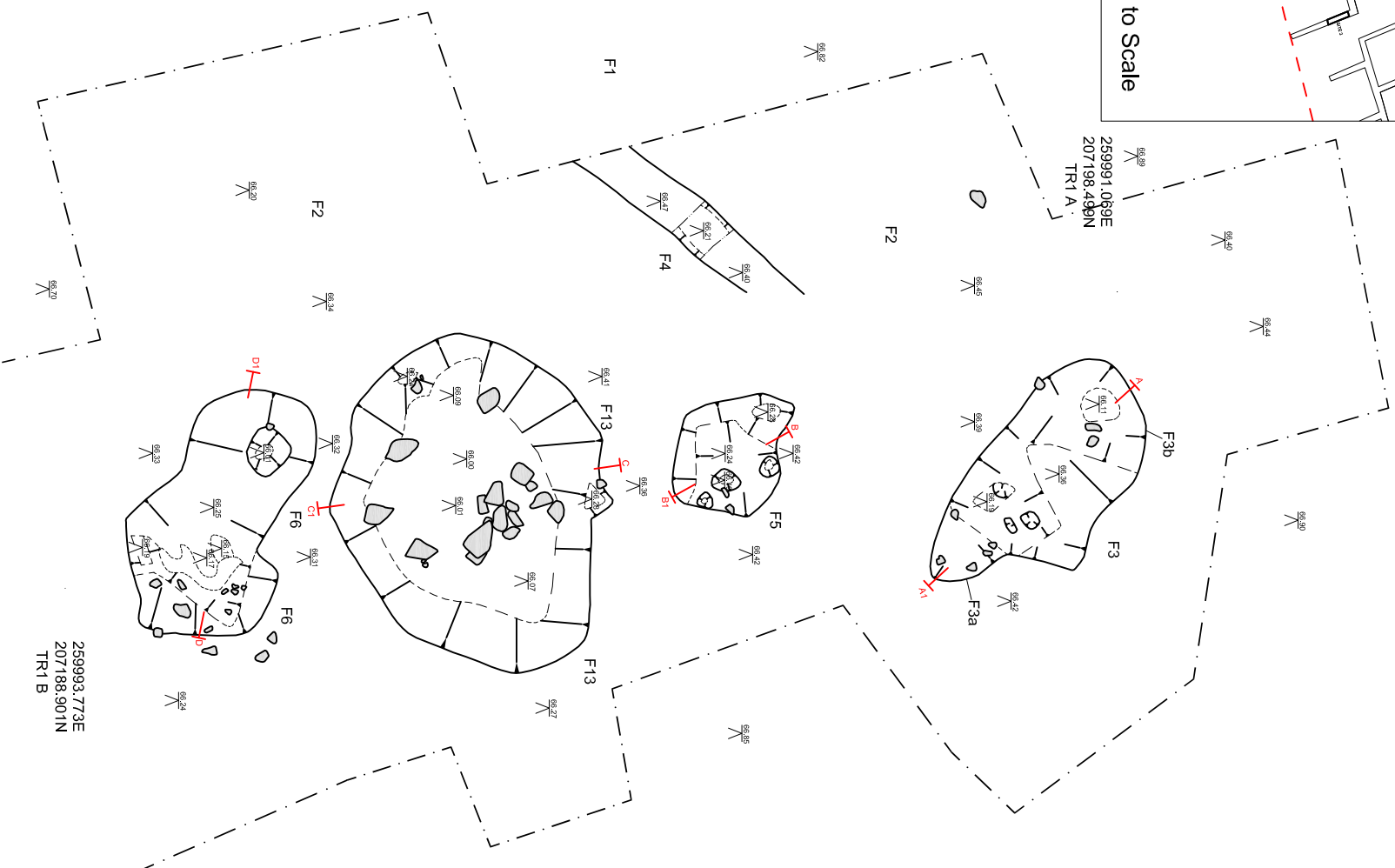
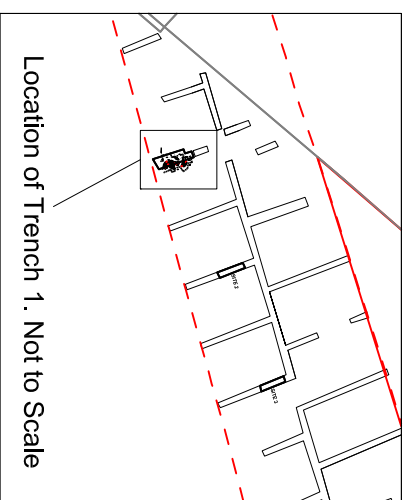

Plan. Scale 1:60

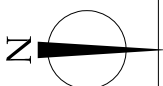

Sections. Scale 1:20

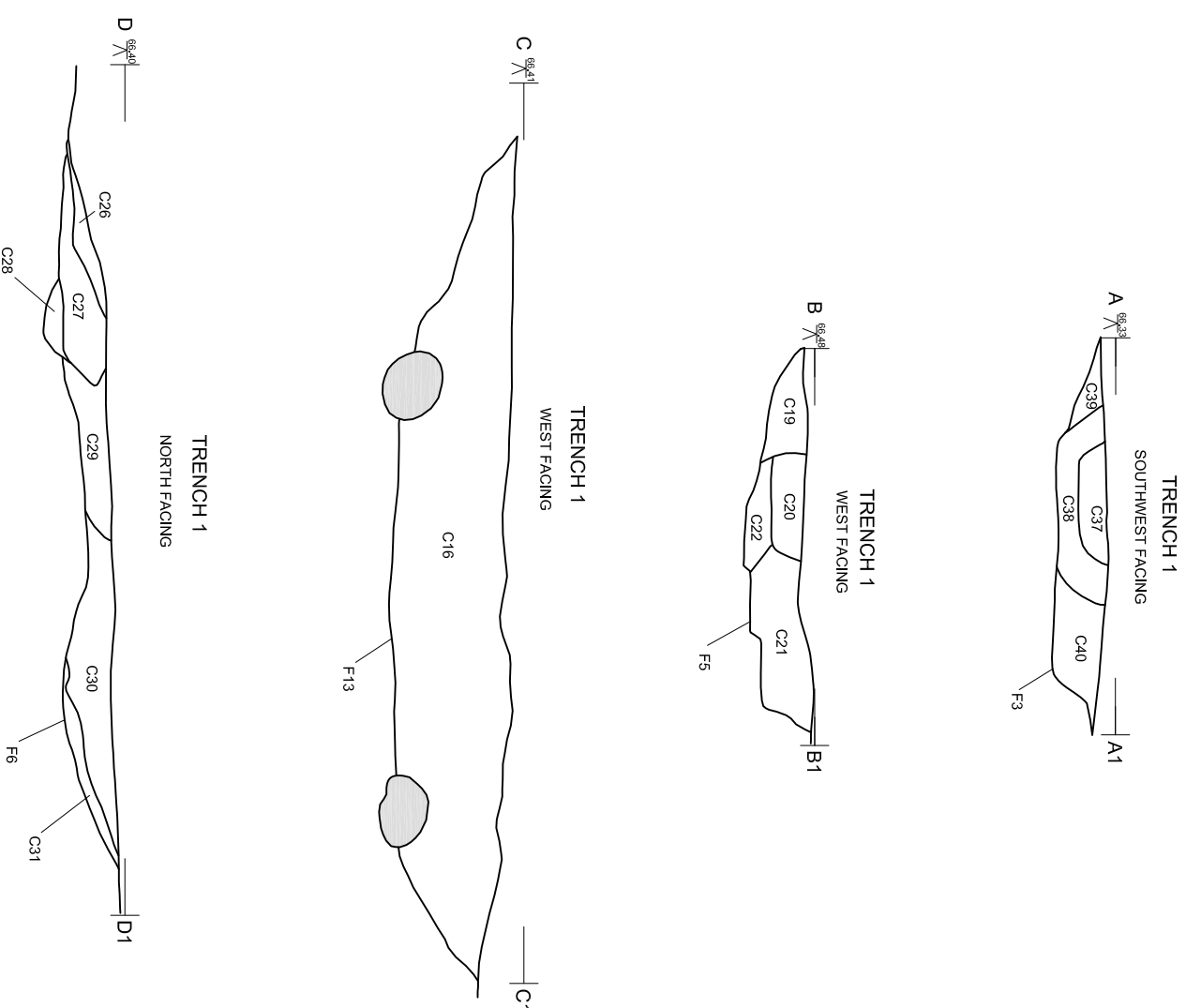

Title
Post excavation plan and sections
for Trench 1, Site I, 03E0679

Notes
 Stone

Job/Exc No.
03E0679

Completed by
GW

CAD reference
1047-03-400/Tera3

Client
Kildare County Council

Date
January 12

Scale
As Shown

Drawing No.
Figure 4

Project
N7 Heath-Mayfield Motorway Scheme



Brethon House
Kilkenny Road
Castlecomer
Co. Kilkenny.
Tel: (+353) 056 4440236
Fax: (+353) 056 4440237
Email: vjk@vjk.ie
Website: www.vjk.ie

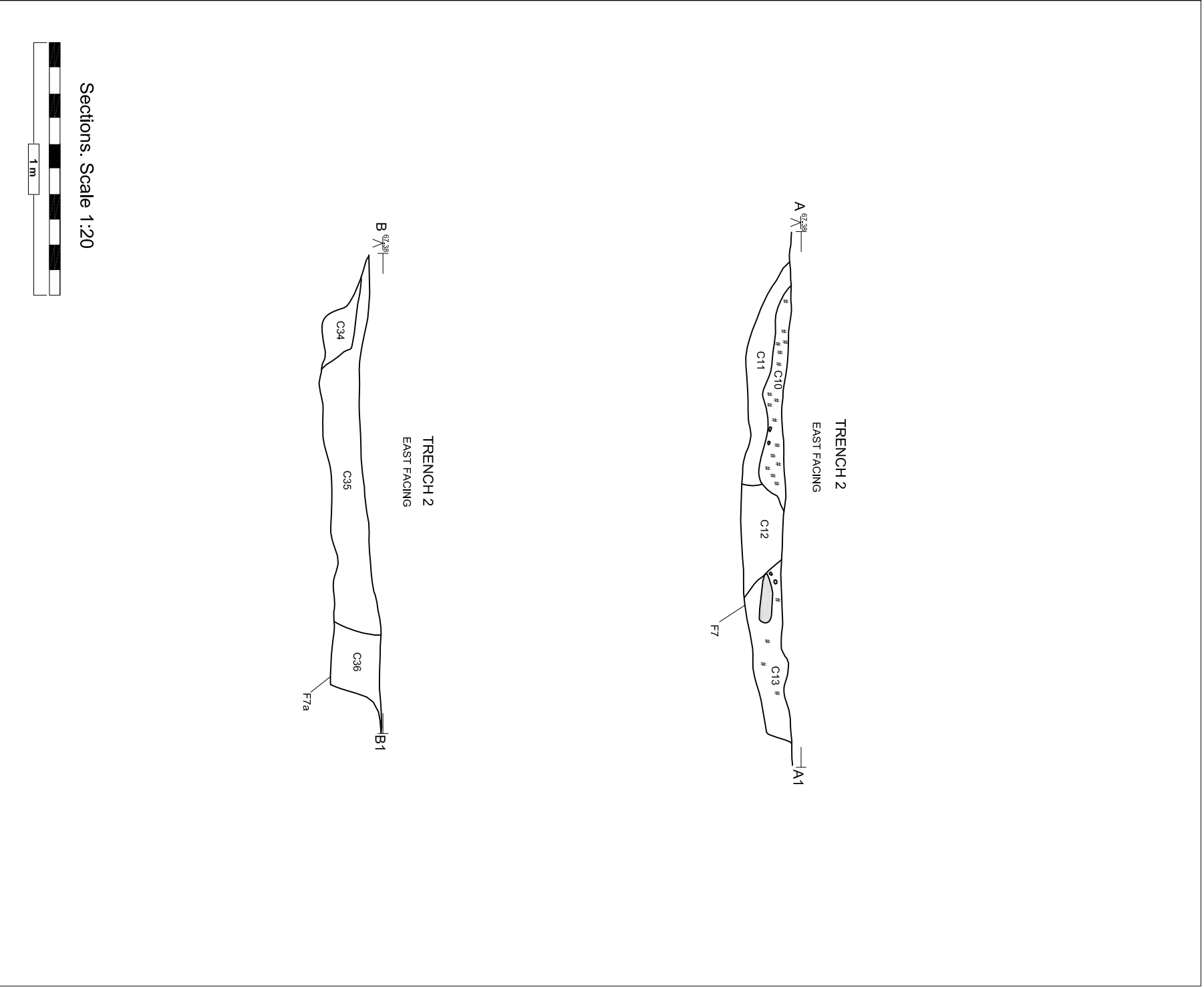
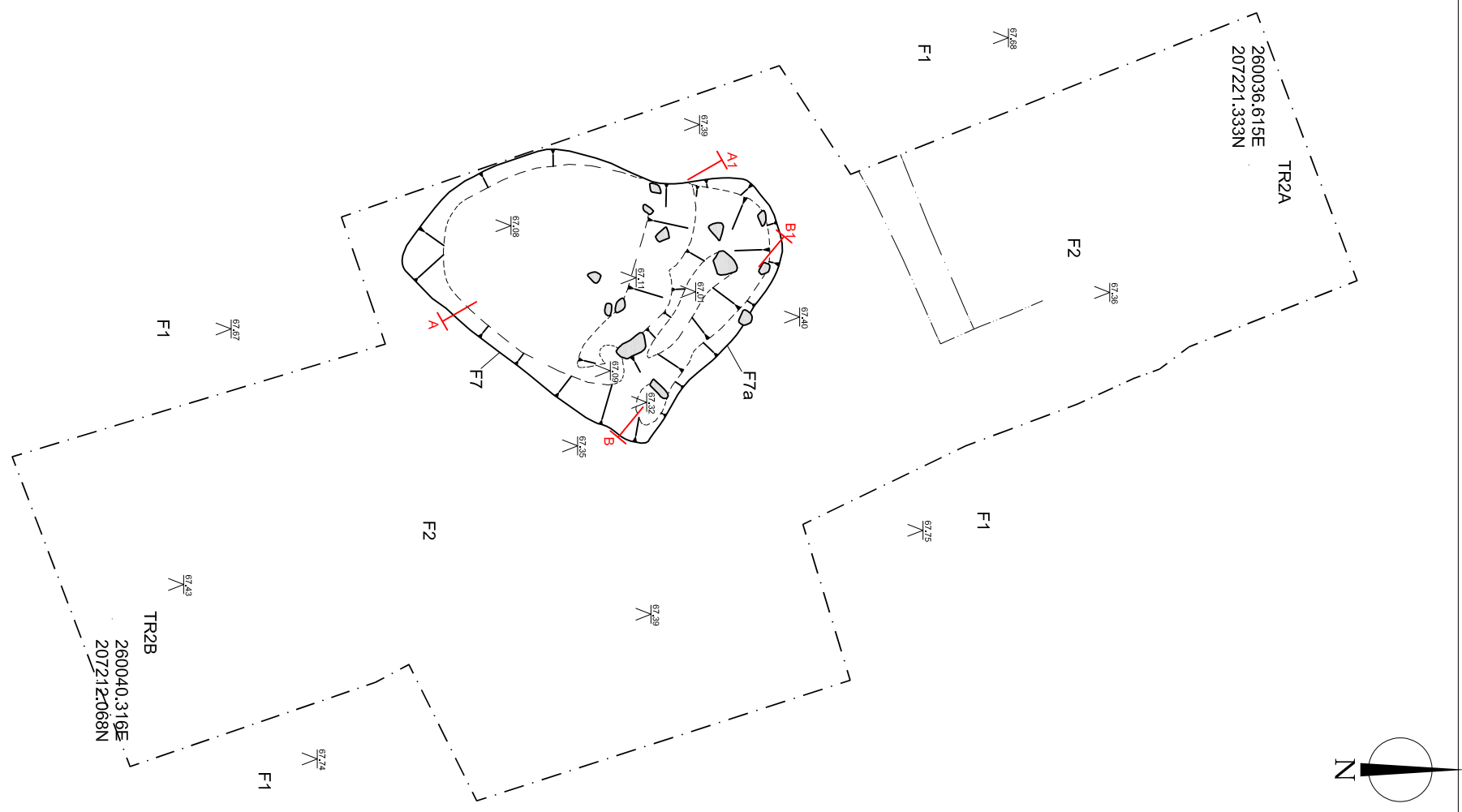
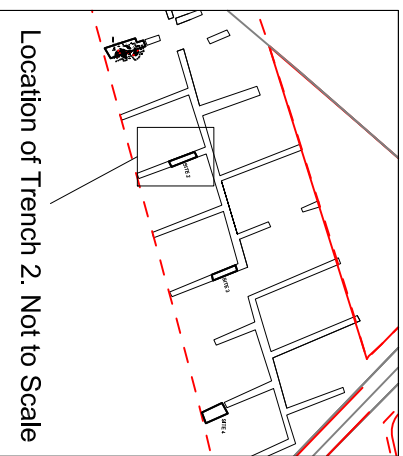

Title
 Post excavation plan and sections
 for Trench 2, Site I, 03E0679

Notes
 # Charcoal
 Stone

Job/Exc No.
 03E0679
Date
 January 12

Completed by
 GW
Scale
 As Shown

CAD reference
 1047-03-400/Tera3
Drawing No.
 Figure 5

Client
 Kildare County Council
Project
 N7 Heath-Mayfield Motorway Scheme

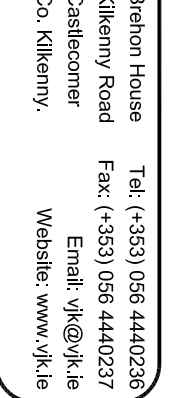

Brehon House
 Kilkenny Road
 Castlecomer
 Co. Kilkenny.
 Tel: (+353) 056 4440236
 Fax: (+353) 056 4440237
 Email: vjk@vjk.ie
 Website: www.vjk.ie

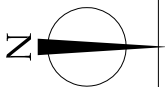
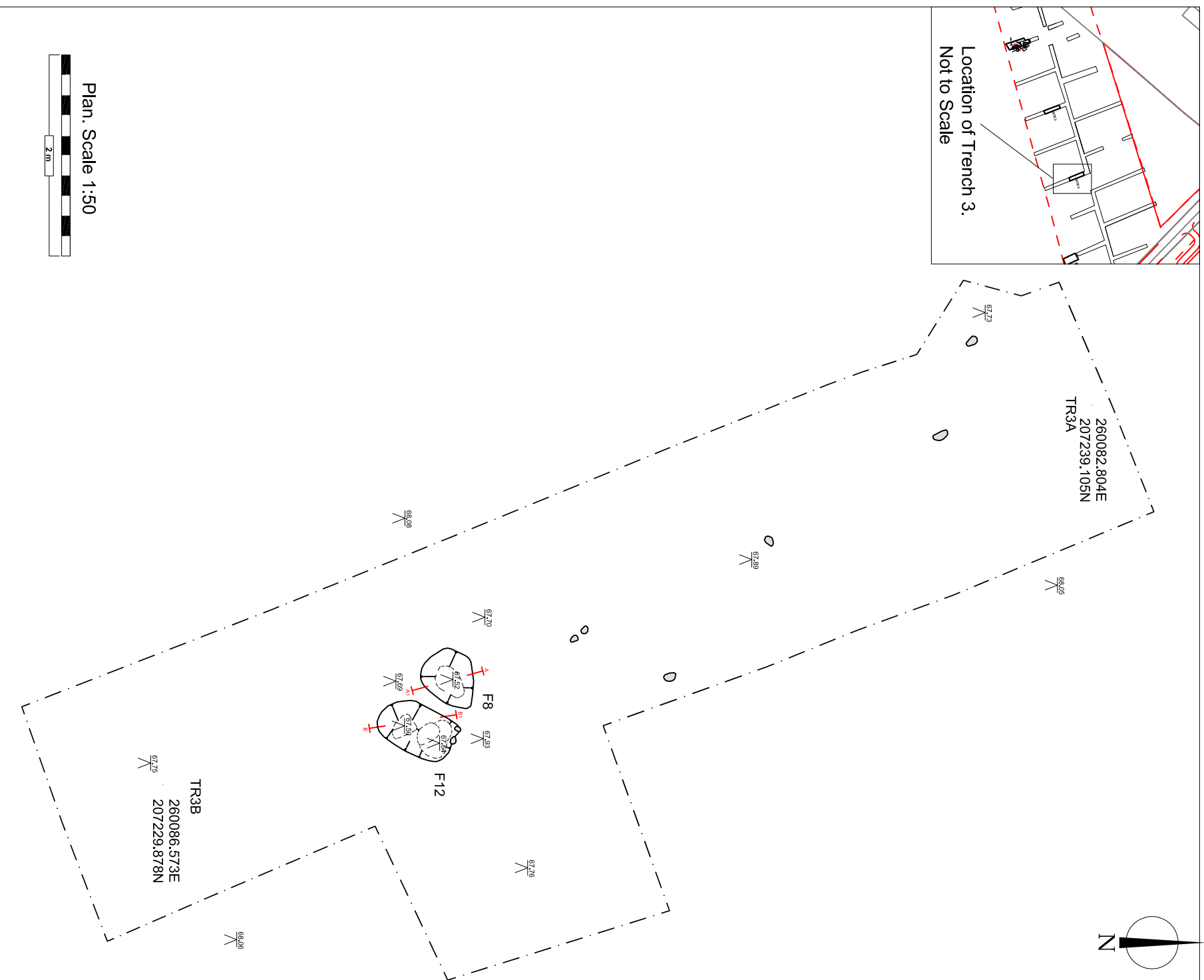
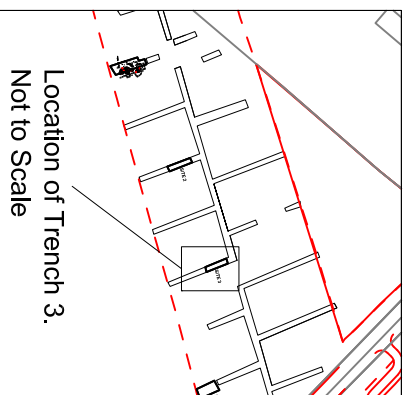

Plan. Scale 1:50

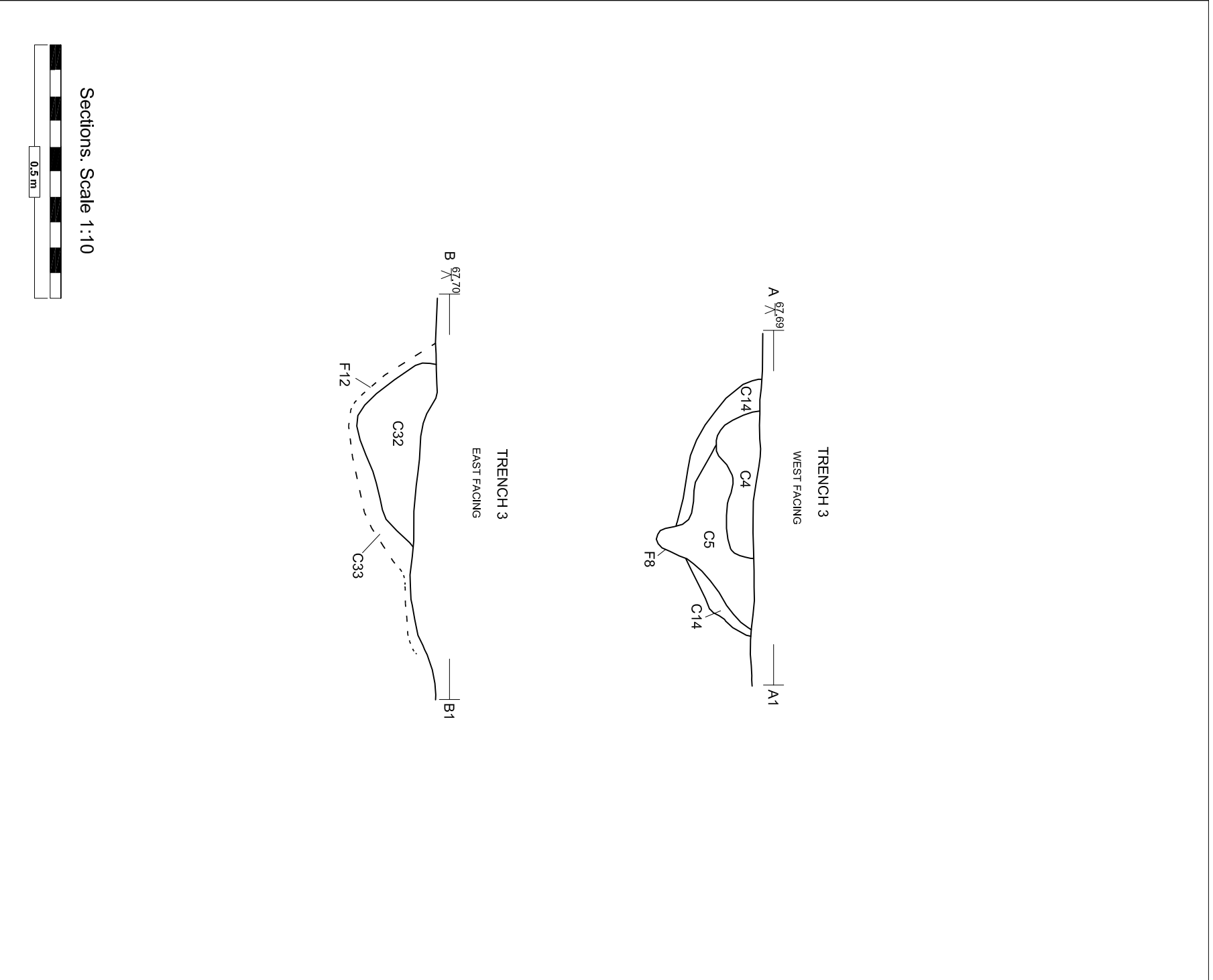

Sections. Scale 1:10



Notes
Stone



Title
Post excavation plan and sections
for Trench 3, Site I, 03E0679

Job/Exc No.
03E0679

Completed by
GW

CAD reference
1047-03-400/Tera3

Client
Kildare County Council

Project
N7 Heath-Mayfield Motorway Scheme



Brethon House
Kilkenny Road
Castlecormer
Co. Kilkenny.

Tel: (+353) 056 4440236
Fax: (+353) 056 4440237
Email: vjk@vjk.ie
Website: www.vjk.ie

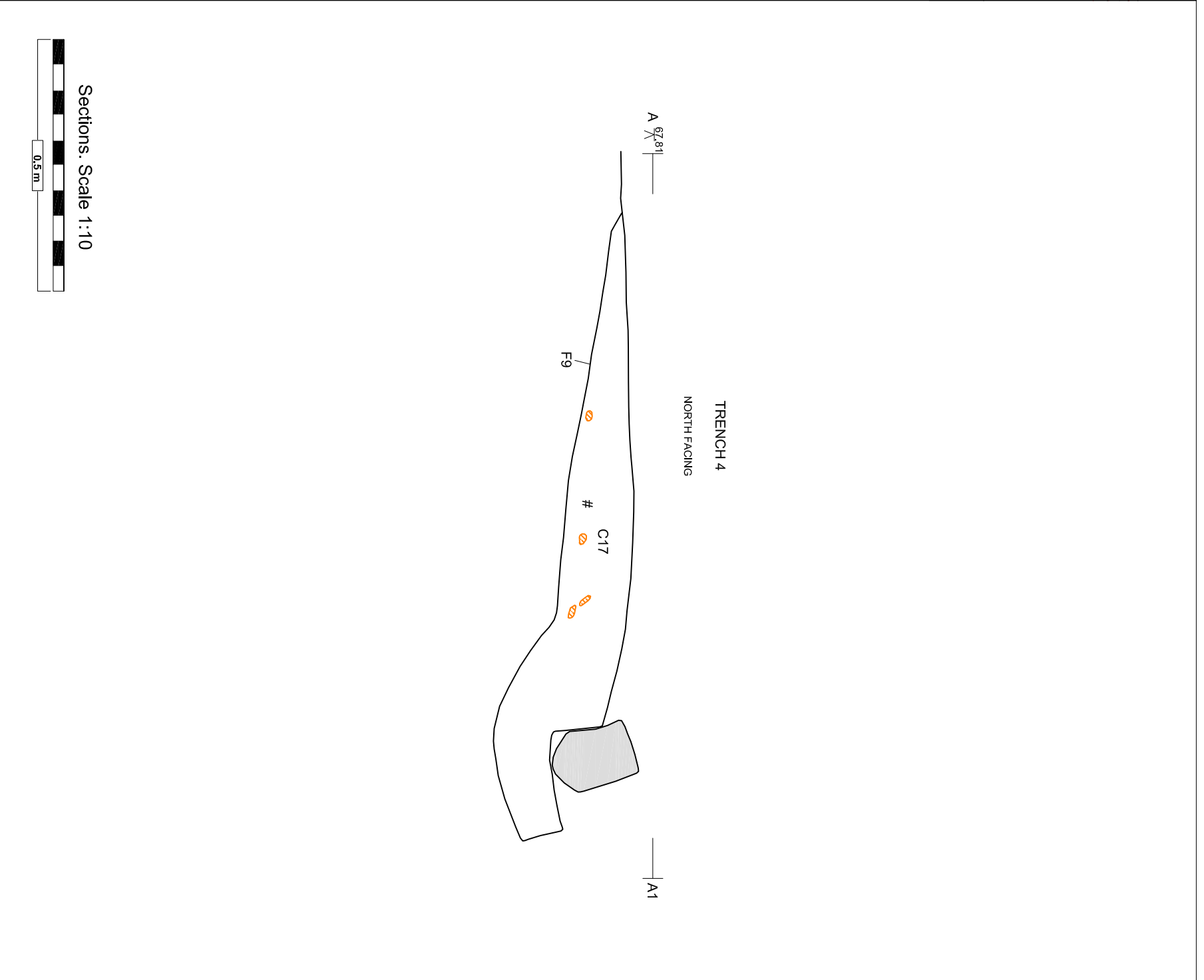
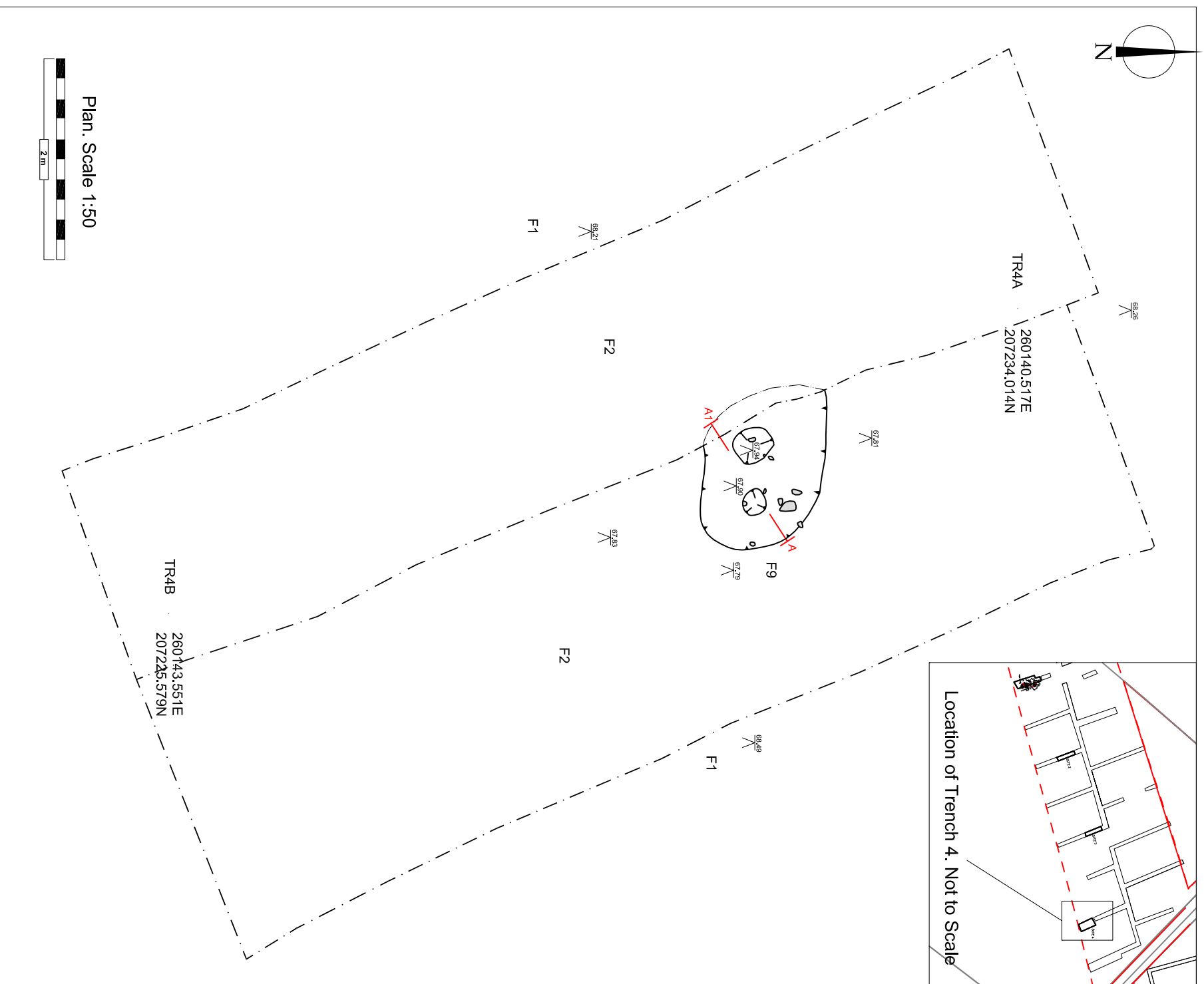

Title
Post excavation plan and sections
for Trench 4, Site I, 03E0679

Notes

Charcoal
 Burnt Soil
 Stone

Job/Exc No.
03E0679

Date
January 12

Completed by
GW

Scale
As Shown

CAD reference
1047-03-400/Tera3

Drawing No.
Figure 7

Client
Kildare County Council



Project
N7 Heath-Mayfield Motorway Scheme

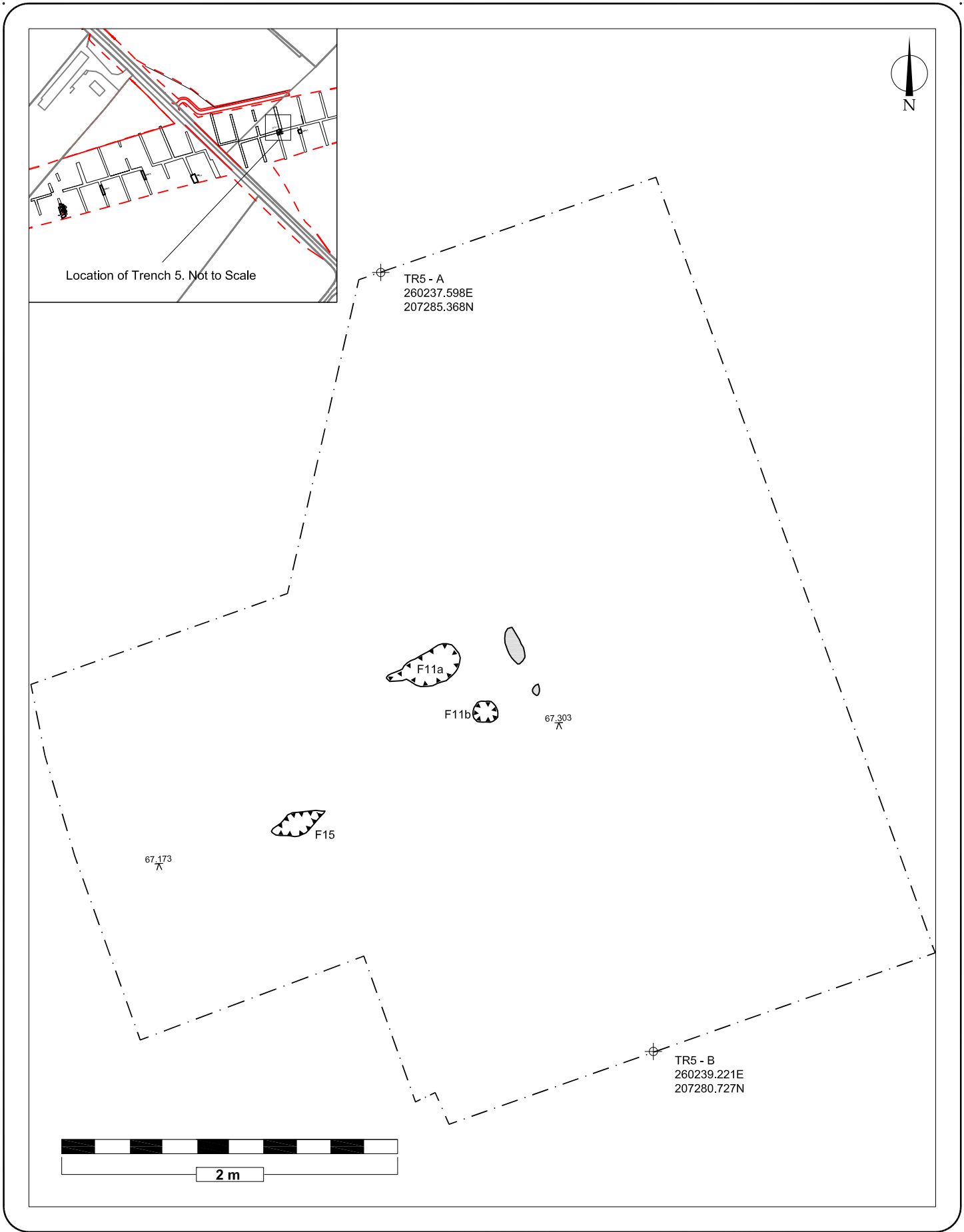

Brehon House
Kilkenny Road
Castlecomer
Co. Kilkenny.

Tel: (+353) 056 4440236
Fax: (+353) 056 4440237
Email: vjk@vjk.ie
Website: www.vjk.ie



Title Post excavation plan of Trench 5			Notes  Stone			 Brehon House Kilkenny Road Castletomer Co. Kilkenny. Tel: (+353) 056 4440236 Fax: (+353) 056 4440237 Email: vjk@vjk.ie Website: www.vjk.ie		
Job No. 03E0679	Drawn by DE	CAD reference 1047-03-400/Tera3	Date January 12	Scale 1:30	Drawing No. Figure 8	Client Kildare County Council		
Project N7 Heath-Mayfield Motorway Scheme								

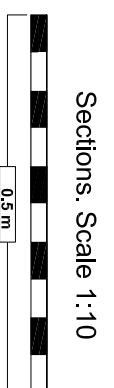
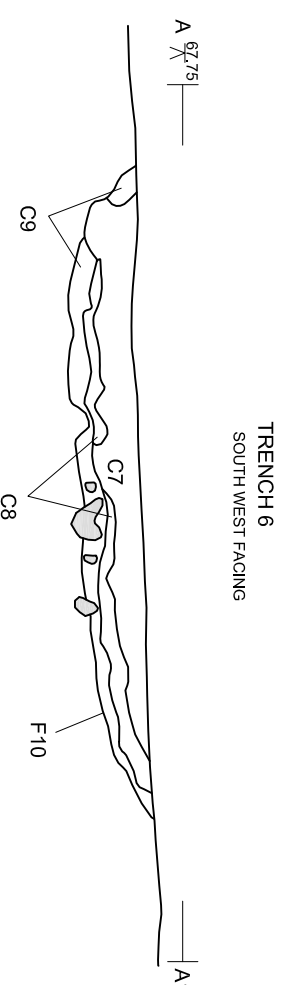
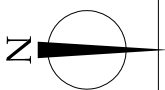
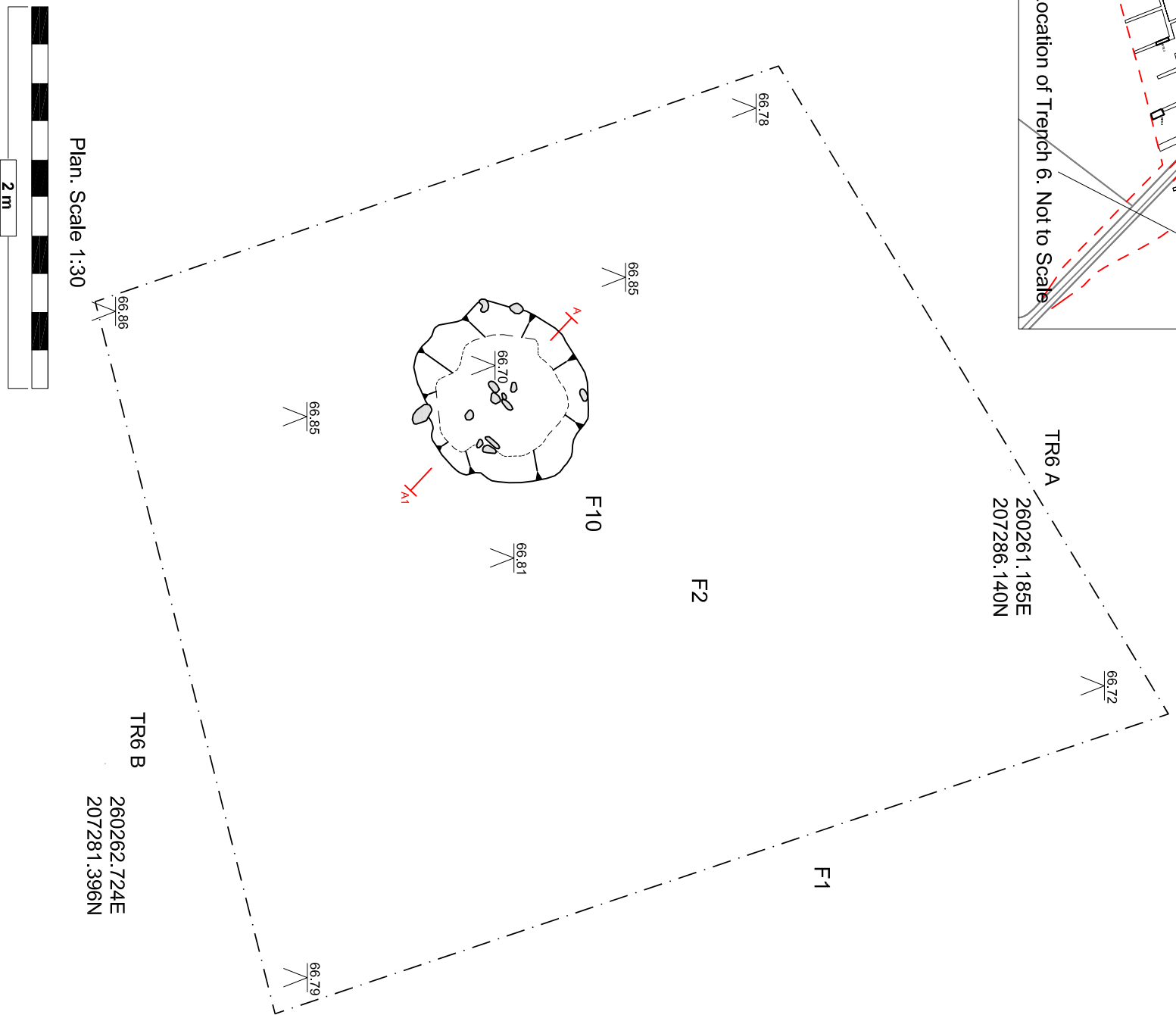
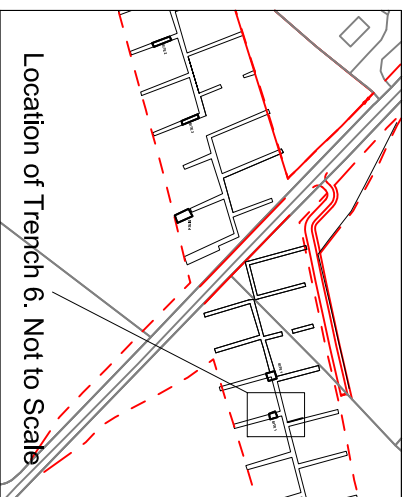

Title
Post excavation plan and sections
for Trench 6, Site I, 03E0679

Notes
 Stone

Job/Exc. No.
03E0679

Completed by
GW

CAD reference
1047-03-400/Tera3

Client
Kildare County Council

Date
January 12

Scale
As Shown

Drawing No.
Figure 9

Project
N7 Heath-Mayfield Motorway Scheme



Brethon House
Kilkenny Road
Castlecomer
Co. Kilkenny.

Tel: (+353) 056 4440236
Fax: (+353) 056 4440237
Email: vjk@vjk.ie
Website: www.vjk.ie