



Bodleian Libraries

UNIVERSITY OF OXFORD

This book is part of the collection held by the Bodleian Libraries and scanned by Google, Inc. for the Google Books Library Project.

For more information see:

<http://www.bodleian.ox.ac.uk/dbooks>



This work is licensed under a Creative Commons Attribution-NonCommercial-ShareAlike 2.0 UK: England & Wales (CC BY-NC-SA 2.0) licence.

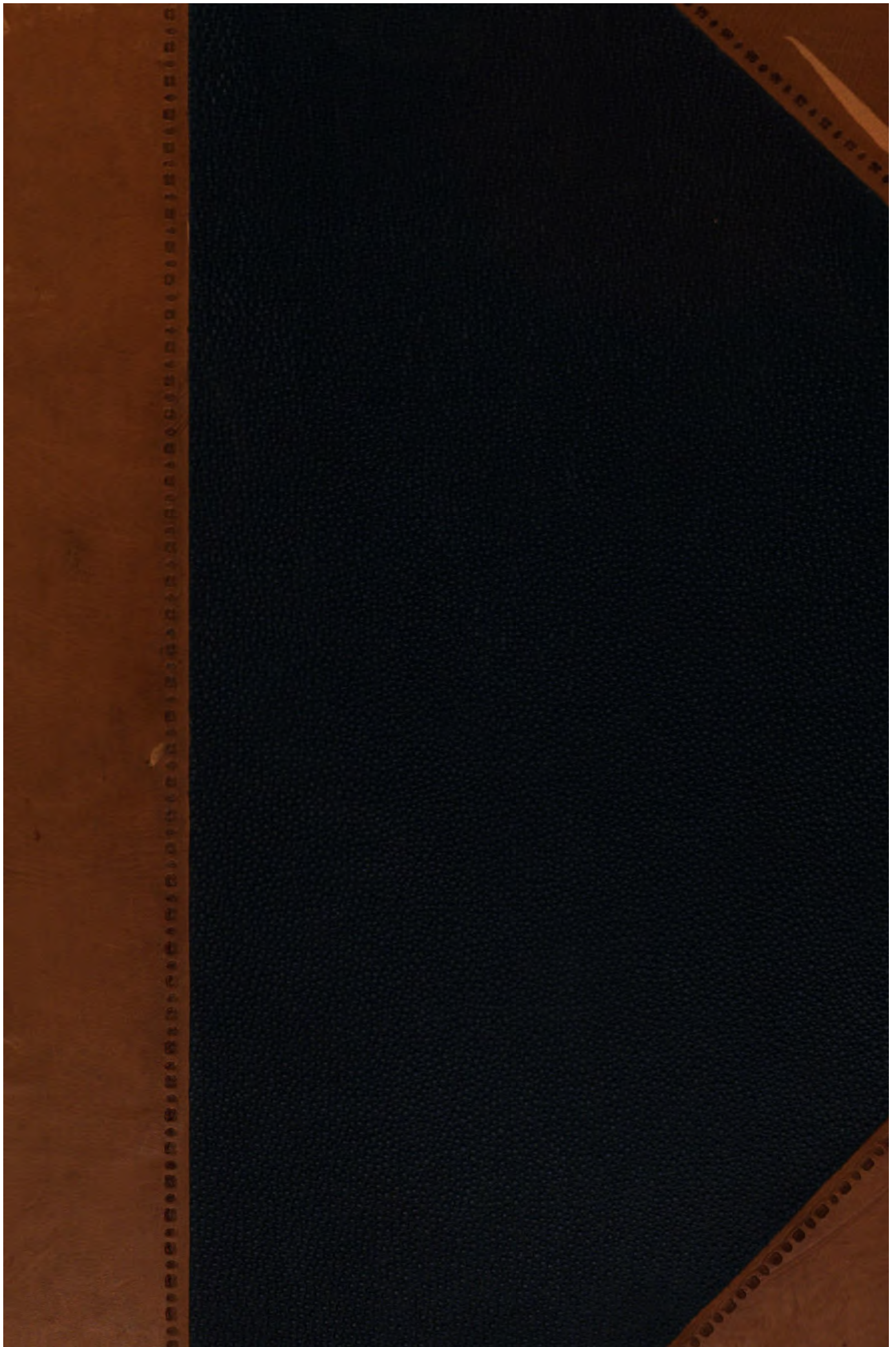



600026738W

PRESS	G. 12.
SHELF	V.
Nº	6

1986 d. $\frac{105}{1}$



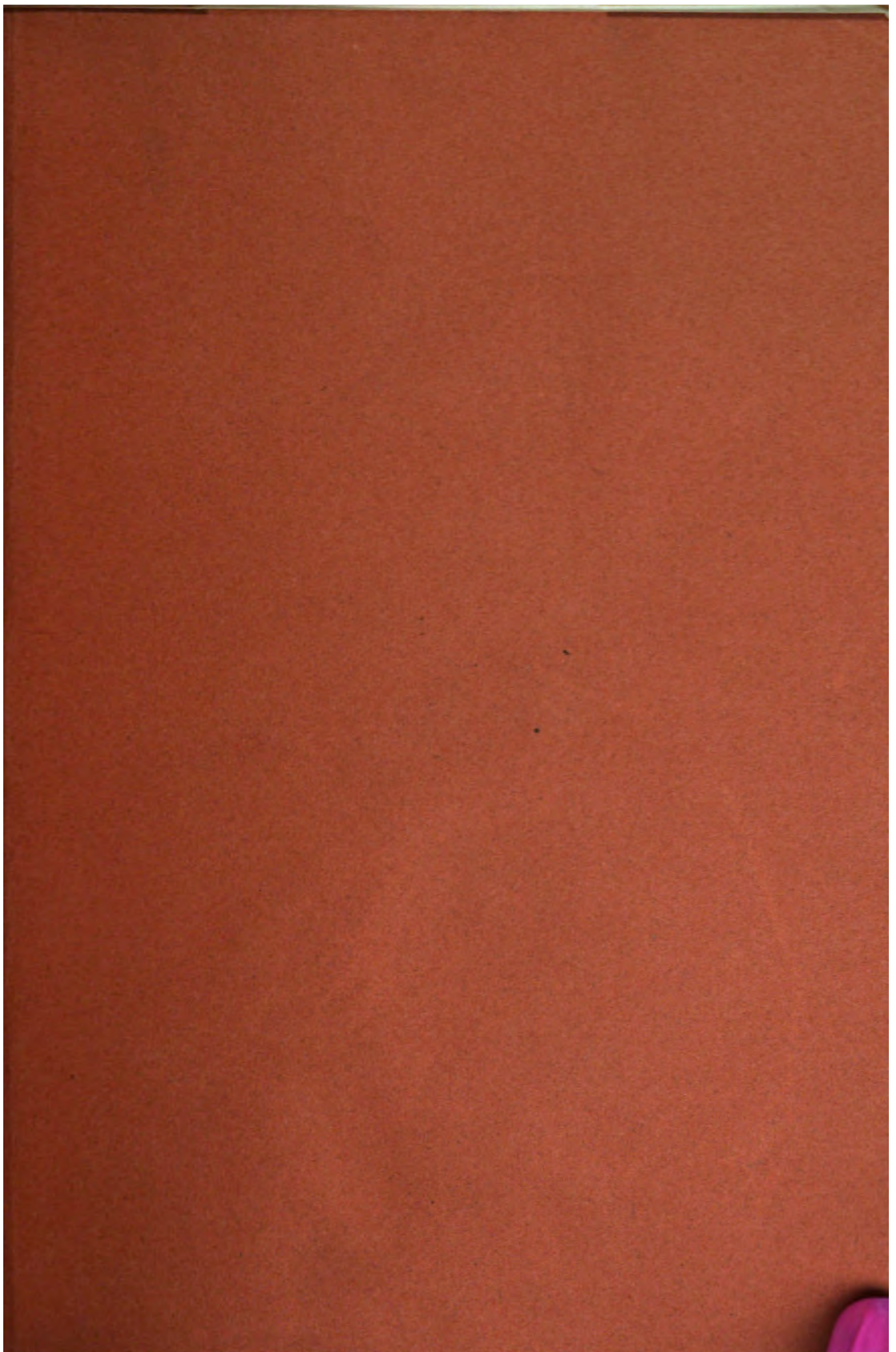

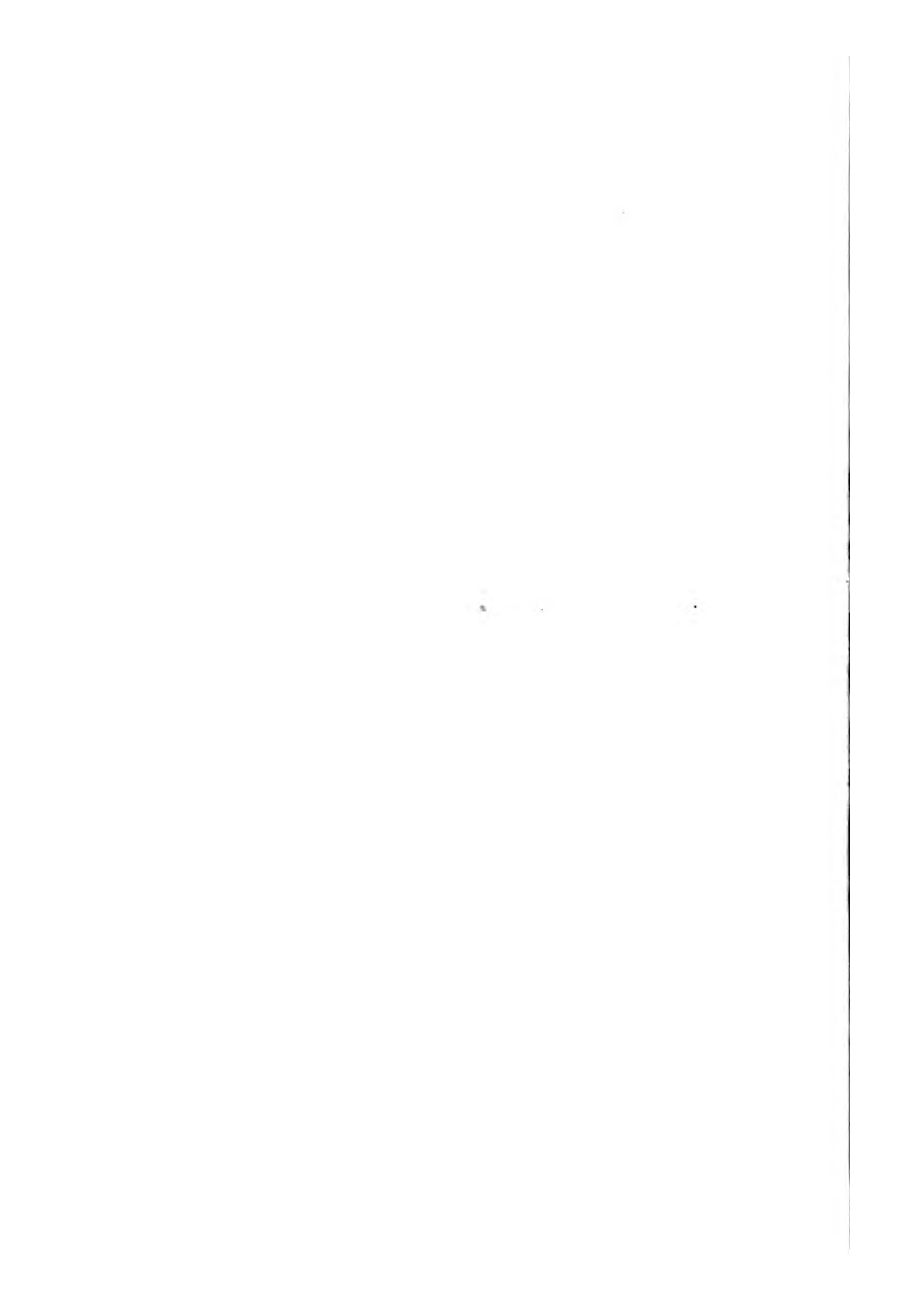

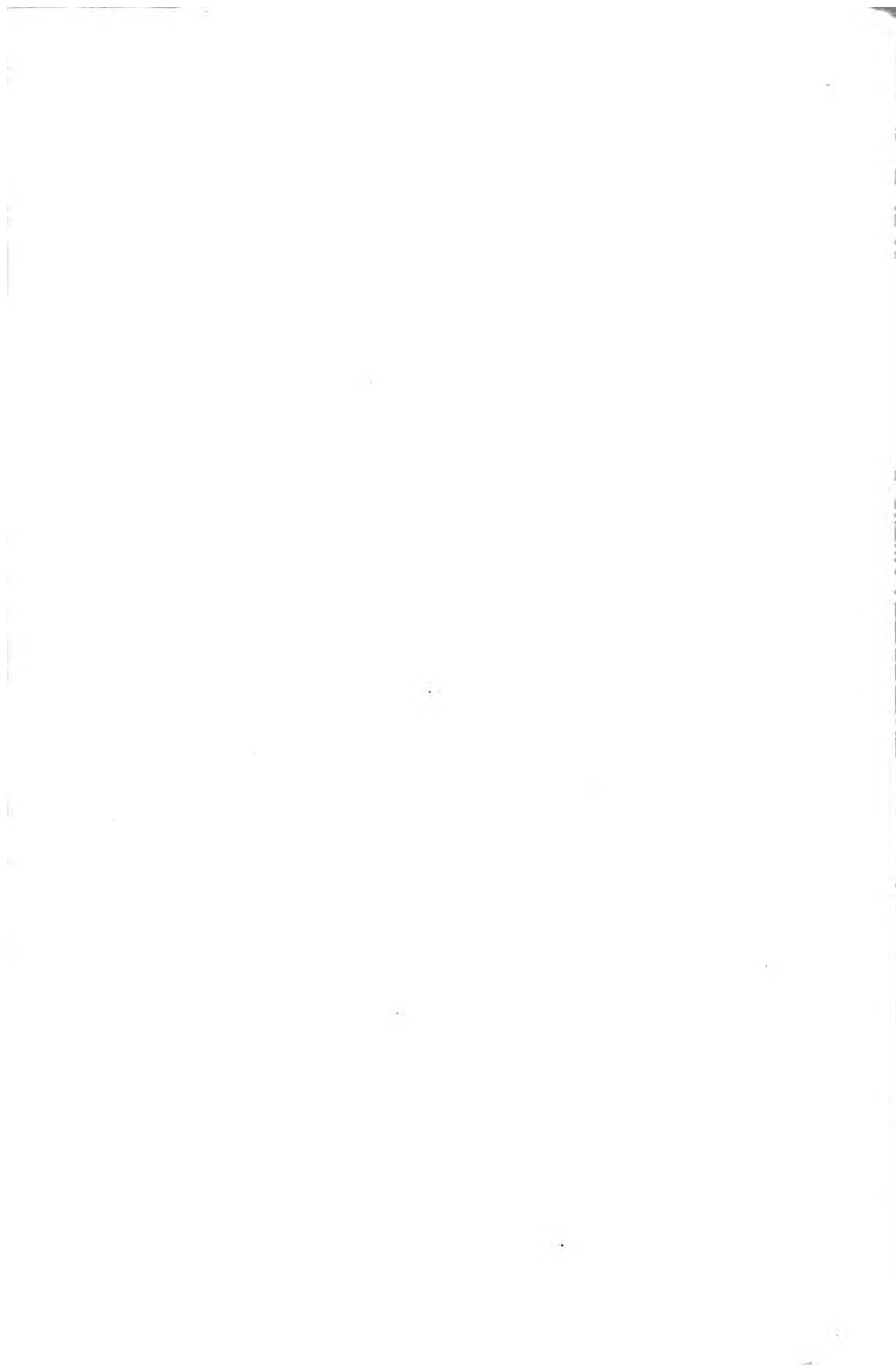

THE
COMPLETE WORKS
OF
COUNT RUMFORD.

PUBLISHED BY THE AMERICAN ACADEMY OF
ARTS AND SCIENCES.



VOL. I.

BOSTON.

1870.

UNIVERSITY PRESS : WELCH, BIGELOW, & Co.,
CAMBRIDGE.



P R E F A C E .

THE American Academy of Arts and Sciences, at a meeting held June 9, 1868, resolved to publish a complete edition of Count Rumford's Works, and made an appropriation of money for that purpose. In accordance with this resolution, the "Rumford Committee" of the Academy undertook to collect the writings of Count Rumford, which are scattered through various scientific Journals and Transactions. No complete edition of these writings has ever been published, although many of them were collected by their author and reprinted under his direction at various times, with the titles of "Essays, Political, Economical, and Philosophical," and of "Philosophical Papers." Of the latter work only one volume was ever published, though, according to Count Rumford's design, there were to have been two. There are also German and French editions of the Essays.

The Committee first prepared as complete a list of Rumford's works as possible, arranging them in chronological order. In selecting the papers for publication it was decided to arrange them according to the order of the list, as far as this could be done without unduly separating papers which relate to the same subject. It has been thought best, after mature deliberation, to publish the papers in their original form, without reference to their relations either to the history or to the subsequent progress of the sciences of which they treat. The papers originally written or first printed in French or German have been carefully translated. The writings of Rumford will probably fill four volumes: the life of their author, by Dr. George E. Ellis, will form an additional volume.

JOSEPH WINLOCK, *Chairman.*

JOSIAH P. COOKE, JR.

FRANK H. STORER.

JAMES B. FRANCIS.

MORRILL WYMAN.

EDWARD C. PICKERING.

WOLCOTT GIBBS.

CONTENTS.

	PAGE
AN ACCOUNT OF SOME EXPERIMENTS UPON GUNPOWDER	I
EXPERIMENTS TO DETERMINE THE FORCE OF FIRED GUN- POWDER	98
A SHORT ACCOUNT OF SOME EXPERIMENTS MADE WITH CAN- NON, AND ALSO OF SOME ATTEMPTS TO IMPROVE FIELD ARTILLERY	173
EXPERIMENTS ON THE PRODUCTION OF AIR FROM WATER, EXPOSED WITH VARIOUS SUBSTANCES TO THE ACTION OF LIGHT	191
AN ACCOUNT OF SOME EXPERIMENTS MADE TO DETERMINE THE QUANTITIES OF MOISTURE ABSORBED FROM THE AT- MOSPHERE BY VARIOUS SUBSTANCES	232
OF THE PROPAGATION OF HEAT IN FLUIDS.	
PART I. — Of a Remarkable Law which has been found to obtain in the Condensation of Water with Cold, when it is near the Temperature at which it freezes; and of the Wonderful Effects which are produced by the Opera- tion of that Law in the Economy of Nature. Together with Conjectures respecting the final Cause of the Salt- ness of the Sea	239
PART II. — An Account of several new Experiments, with occasional Remarks and Observations, and Conjectures respecting Chemical Affinity and Solution, and the Me- chanical Principle of Animal Life	337
OF THE PROPAGATION OF HEAT IN VARIOUS SUBSTANCES	401
AN EXPERIMENTAL INQUIRY CONCERNING THE SOURCE OF THE HEAT WHICH IS EXCITED BY FRICTION	469



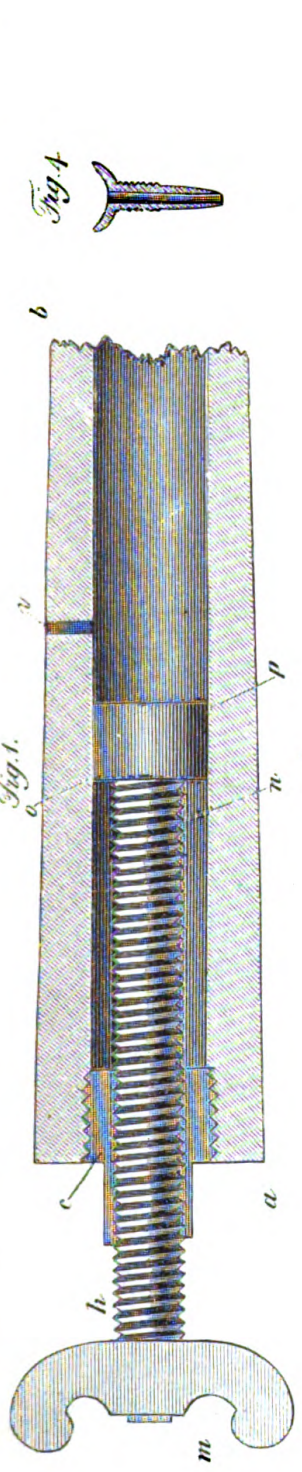

Fig. 1.

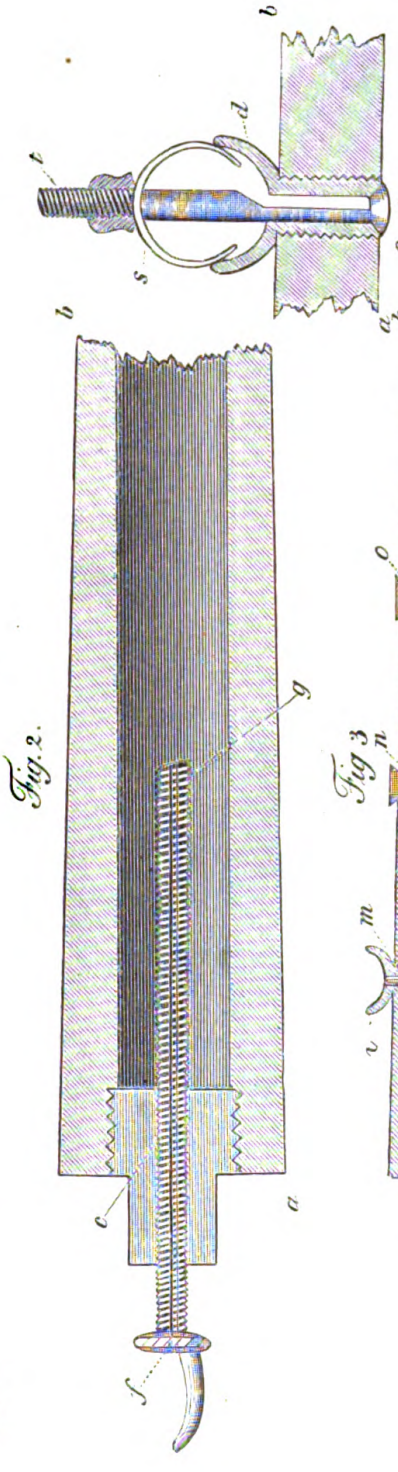

Fig. 2.

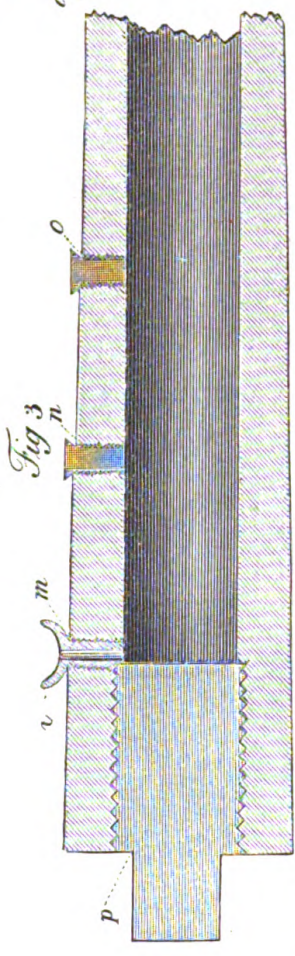

Fig. 3.



Fig. 4.

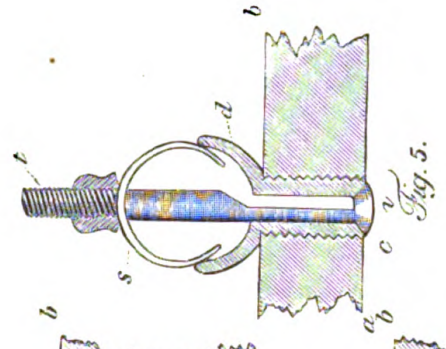

Fig. 5.

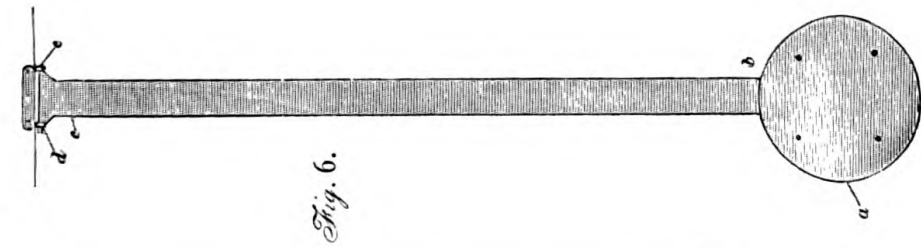

Fig. 6.

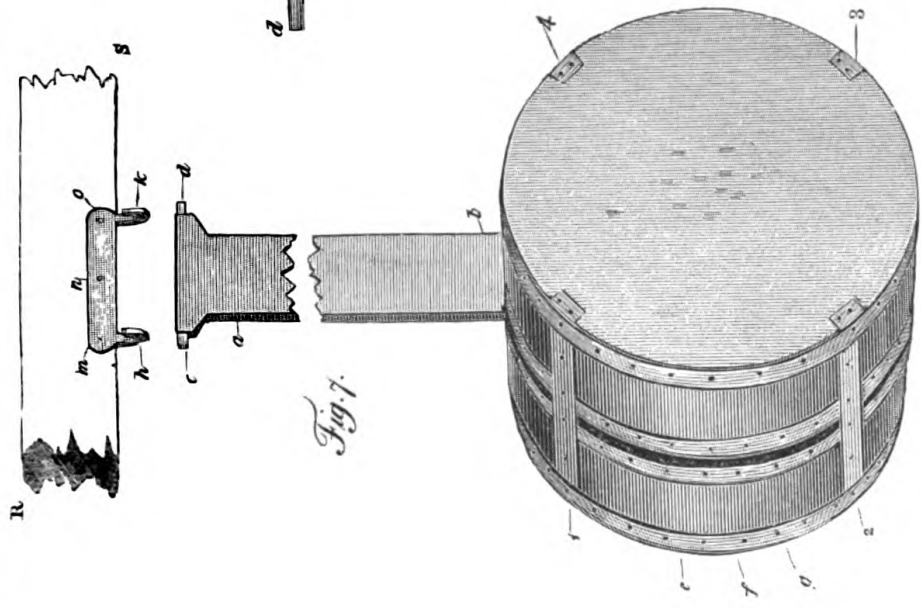

Fig. 7.

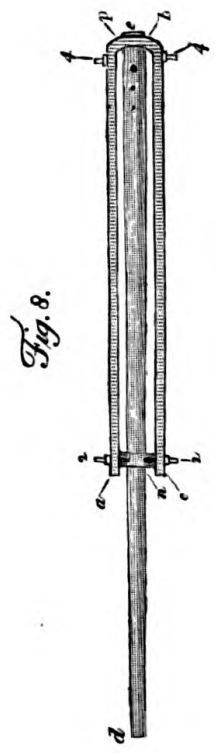

Fig. 8.

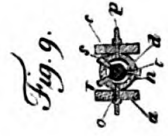

Fig. 9.



Fig. 10.

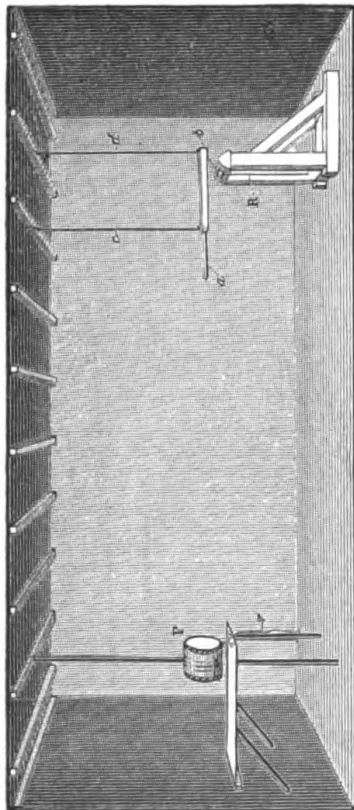
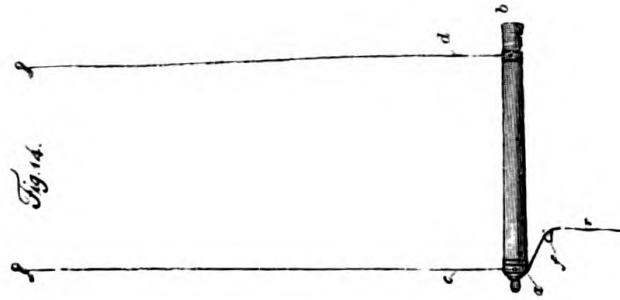
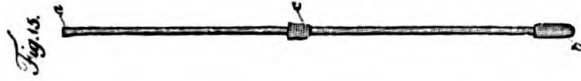
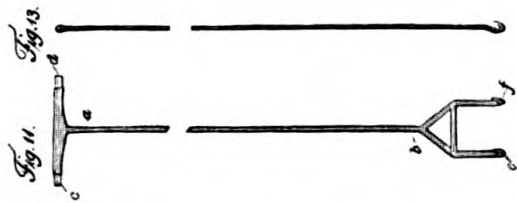
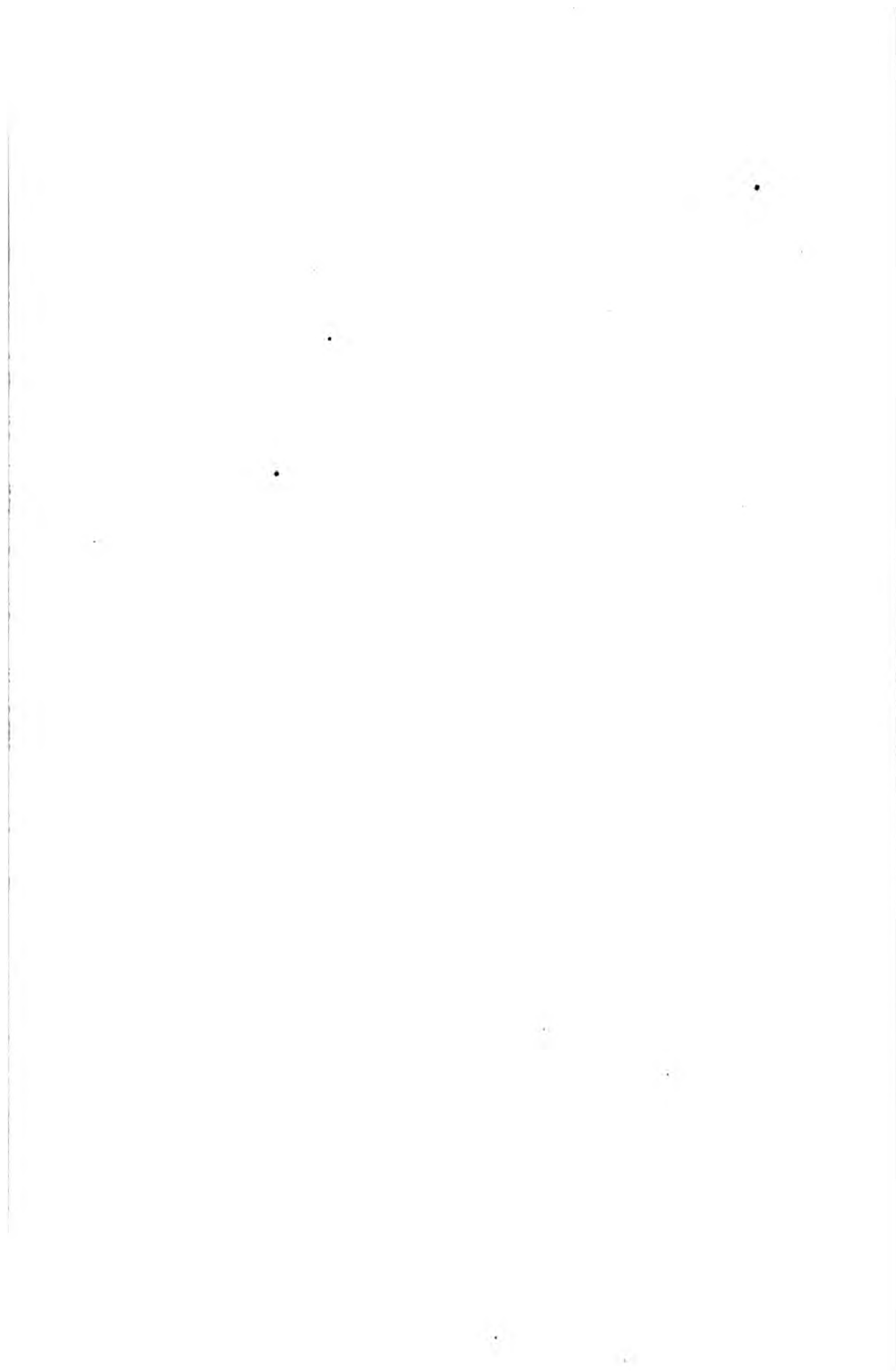
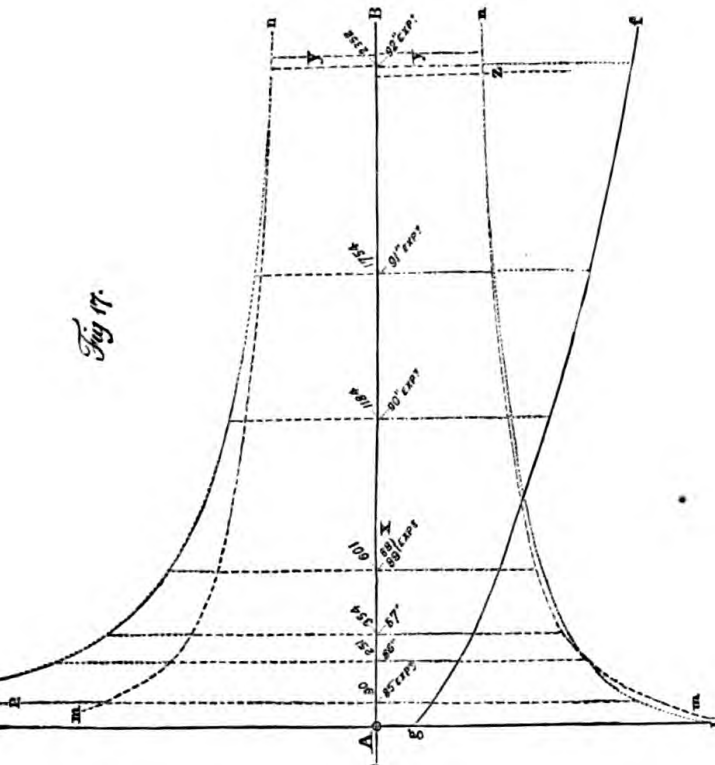
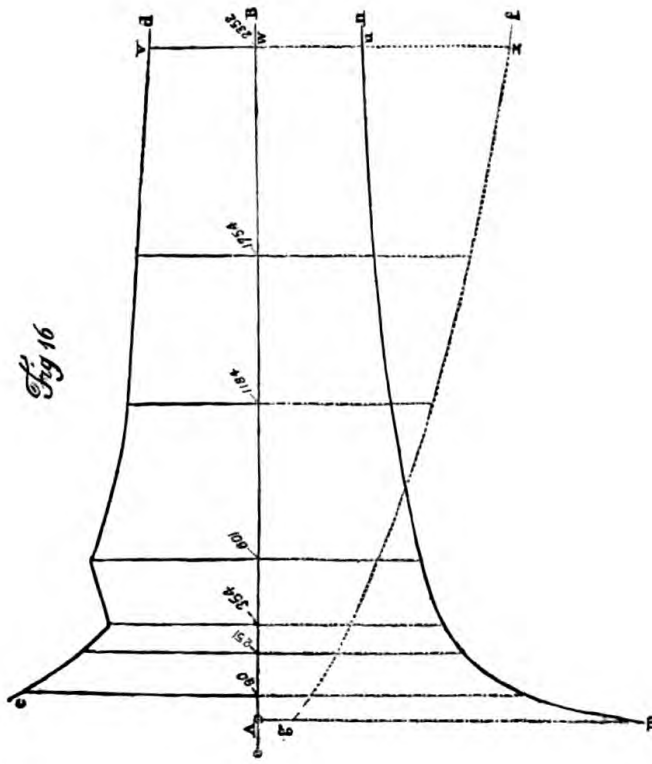
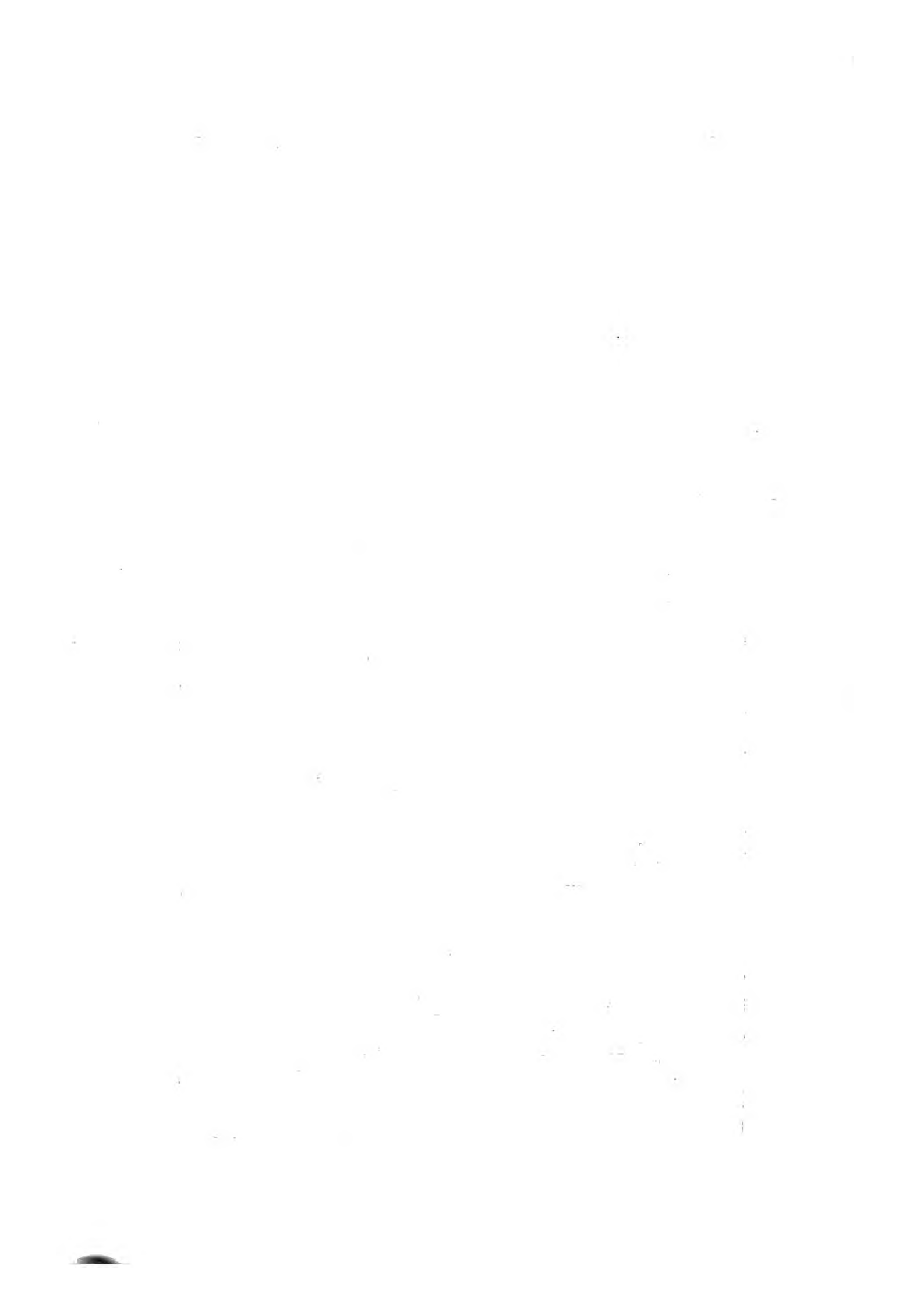

Fig. 12.









AN ACCOUNT

OF

SOME EXPERIMENTS UPON GUNPOWDER,

*With occasional Observations and practical Inferences,
to which are added an Account of a new Method of
determining the Velocities of all Kinds of Military
Projectiles, and the Description of a very accurate
Epreuve for Gunpowder.*

THESE experiments were undertaken principally with a view to determine the most advantageous situation for the vent in fire-arms, and to measure the velocities of bullets, and the recoil under various circumstances. I had hopes, also, of being able to find out the velocity of the inflammation of gunpowder, and to measure its force more accurately than had hitherto been done. They were begun in the month of July, in the year 1778, at Stoneland Lodge, a country seat belonging to Lord George Germain; and I was assisted by the Reverend Mr. Bale, rector of Withyham, who lives in the neighbourhood.

The weather proved remarkably favourable for our experiments, being settled and serene, so that the course of them was never interrupted for a whole day by rain or by any accident. The mercury in the barometer stood, in general, pretty high, and the temperature of the atmosphere was very equal and

moderately warm for the season. In order that each experiment might, as nearly as possible, be made under similar circumstances, they were all made between the hours of ten in the morning and five in the afternoon; and after each experiment the piece was wiped out with tow till the inside of its bore was perfectly clean, and as bright as if it had just come out of the hands of the maker; and great care was taken to allow as much time to elapse between the firings as was necessary to render the heat of the barrel nearly the same in every experiment.

A Description of the Apparatus.

The barrel principally used in these experiments was made by Wogdon, one of the most famous gunsmiths in London; and nothing can exceed the accuracy with which it is bored, or the fineness of the polish on the inside. It is made of the very best iron, and, agreeably to Mr. Robins's advice, I took care to have it well fortified in every part, that there might be no danger of its bursting. Its weight and dimensions may be seen in the table of the weight and dimensions of the apparatus, p. 14.

Fig. 1 represents a longitudinal section of a part of the barrel, with the apparatus first made use of for shifting the vent from one part of the chamber to another, or rather for moving the bottom of the chamber further from, or bringing it nearer to, the vent, in order that the fire might be communicated to the powder in different parts of the charge.

a, b, represent the lower part of the barrel. *c* is the breech-pin, which is perforated with a hole four tenths

of an inch in diameter, the axis of which perforation coincides with the axis of the bore.

Into this hole the screw *h, n*, about four inches in length, is fitted; to the end of which, *n*, that passes up into the bore, is fixed a piston, *o, p*, which, by means of collars of oiled leather, is made to fit the bore of the piece very exactly. The end of the piston *p*, nearest the muzzle, is of brass, and forms a moveable bottom to the bore, which by turning the screw *h, n*, by means of the handle *m*, is brought nearer to, or removed further from, the fixed vent *v*, by which means the powder is lighted at any assignable distance from the bottom of the charge.

But the length of the bore being altered by moving the piston, which occasioned a small inaccuracy, and some inconvenience attending the apparatus, it was laid aside, and another, represented by Fig. 2, was substituted in the room of it.

a, b, is a section of part of the barrel as before, and *c* is the breech-pin, which, being perforated with a small hole through its center, receives the screw *f, g*, which is about two tenths of an inch in diameter, and four inches long. This screw, being perforated with a very small hole, serves to convey the fire into the chamber of the piece, and by screwing it further up into the bore, or drawing it backwards, the fire is communicated to different parts of the charge.

But, this method being found to be not entirely free from inaccuracies and inconveniences, a third was substituted in the room of it, which was found to answer much better than either of the preceding.

The end of the bore was now firmly closed by a solid breech-pin, *p*, Fig. 3, and three vent-holes, *m, n*, and *o*,

were made in the barrel ; one of them, *m*, even with the bottom of the bore, and the other two at different distances from it. Any two of these vent-holes, as *n* and *o*, for instance, being closed up by solid screws, a perforated screw, or vent-tube, *v*, was screwed into the third, which served to contain the priming, and to convey the fire to the powder lodged in the bore of the piece.

Sometimes a longer vent-tube, represented by Fig. 4, was made use of, which, passing through the powder in the chamber of the piece, communicated the fire immediately to that part of the charge that lay in the axis of the bore.

Another vent-tube, also, was used occasionally, which differs in many respects from both those that have been described. It is so constructed as to convey the fire to the charge ; but as soon as the powder in the chamber of the piece begins to kindle, and the elastic fluid to be generated, the vent is firmly closed by a valve, and no part of the generated fluid is permitted to escape. This I shall call the *valve-vent*, and it is represented by Fig. 5, upon an enlarged scale, that the parts of it may appear more distinct.

a, b, is a longitudinal section of a small portion of the solid side of the barrel.

c, d, is the vent-tube, which is in all respects like the short vent-tube commonly made use of, except only that in this the end of the vent-hole (*c*), which goes into the chamber, is enlarged in the form of the wide end of a trumpet or funnel.

To this enlarged aperture the valve, *v*, is accurately fitted, and by means of the small stem or tail, *t*, which is fixed to the valve, and which passes up through the vent-hole, and is connected with the spring, *s*, the valve

is pressed, or rather drawn into its place, and the vent is closed. The stem of the valve was at first made cylindrical; but in order to make way for the priming to pass down to the valve, one half of its substance was taken away, as is represented in the figure.

When this vent is primed, the space between the vent-hole and the stem of the valve is filled with fine-grained powder, and the valve is gently opened, by pressing upon the end of the stem till one or more grains of powder lodge themselves between the valve and the aperture; which preventing the valve from closing again, a small opening is left for the passage of the flame into the chamber of the piece; when the priming is lighted, the fire passing down the vent, and entering the chamber, inflames the charge, and the small grains of powder that were lodged between the valve and the aperture being destroyed by the flame in its passage through the vent, the valve immediately closes, and prevents the escape of any part of the elastic fluid generated by the inflammation of the powder in the chamber of the piece. The pressure of this fluid upon the valve assists the action of the spring, by which means the valve is more expeditiously and more effectually closed.

The valve was very accurately fitted to the aperture by grinding them together with powdered emery and afterwards polishing them one upon the other. And it is very certain that no part of the elastic fluid made its escape by this vent; for, upon firing the piece, there was only a simple flash from the explosion of the priming, and no stream of fire was to be seen issuing from the vent, as is always to be observed when a common vent is made use of, and in all other cases where this fluid finds a passage.

In order that every part of the apparatus employed in these experiments might be as perfect as possible, all the more delicate parts of it were executed by Mr. Frazer, mathematical instrument maker in Duke's Court, St. Martin's Lane, and, among the rest, all the contrivances just described relative to the vent.

The velocities of the bullets were determined by means of a pendulum, according to the method invented by Mr. Robins.

The pendulum I made use of (Fig. 6) is composed of a circular plate of hammered iron (*a*) 13 inches in diameter and 0.65 of an inch thick, to which is firmly fastened a bar of iron (*b, c,*) 56.5 inches in length, 2.6 inches broad, and half an inch in thickness, by which it is suspended, by means of two pivots (*d, e*), at the end of the bar (*c*) and at right angles to its length. These pivots being very accurately finished, and moving on polished grooves, which were kept constantly oiled to lessen the friction, the vibration of the pendulum was very free, as appeared by the great length of time its vibrations continued after it had been put in motion, and was left to itself. To the circular plate of the pendulum, targets of circular pieces of wood of different thicknesses were fixed, which in the course of the experiments were often spoiled and replaced; and in order to mark the weight and dimensions of the pendulum in each experiment, the pendulums are numbered according to the different targets that were made use of; and the weight and dimensions of each pendulum are set down in a table at the end of the description of the apparatus.

The target of the pendulum No. 1 was made of a circular piece of elm-plank, $3\frac{1}{2}$ inches thick, and equal in diameter to the iron plate of the pendulum to which

it was fixed ; but this target, being too thin, was very soon ruined.

The pendulum No. 2 was furnished with two targets, which were circular pieces of very tough oak-plank, near five inches thick, placed on opposite sides of the plate of the pendulum, and firmly fixed to it by screws, and to each other by iron straps. When one of these targets was ruined the pendulum was turned about and the other was made use of. This pendulum lasted from experiment No. 9 to experiment No. 39, when it was so much shattered as to be rendered unfit for further service.

The pendulum No. 3 was like No. 2 ; only, instead of oak, elm-plank, near seven inches in thickness, was made use of for the targets. This pendulum served from experiment No. 40 to experiment No. 101, inclusively.

But finding that targets made of planks of the toughest wood were very soon shattered to pieces by the bullets, I composed the pendulum No. 4 in a different manner. Instead of circular pieces of plank, solid cylinders of elm-timber were made use of for the targets, so that the bullets now entered the wood in the direction of its fibres. These cylinders are 13 inches in diameter, and about $5\frac{1}{2}$ inches in length, hooped with iron at both their ends, to prevent their splitting, and they are firmly fastened to the plate of the pendulum and to each other by four iron straps. This pendulum lasted till the experiments were finished. It is still in being, and appears to be very little the worse for the service it has undergone.

Fig. 7 shows the two ends of the pendulum upon a large scale, together with the hooks by which it was suspended.

a, b, is the bar of the pendulum which is seen broken off, as there is not room to shew the whole of its length.

c, d, are the pivots by which it was suspended. *e* is the circular plate of the pendulum, to which *f, g*, two circular targets, are fastened by screws, and by means of the iron straps 1, 2, 3, 4, which are nailed to the edges of the targets. *h, k*, are the hooks which served to receive the pivots *c, d*, of the pendulum.

The hooks were firmly fixed to the horizontal beam R, S, which supported the whole apparatus by means of three screws, *m, n, o*, which passed through three holes in the plate that connects the two hooks. When the hooks are fastened to the beam, the middle screw, *n*, was first put into its place, and the pendulum was allowed to settle itself in a position truly vertical, after which the hooks were immoveably fixed by means of the screws *m, o*.

The chord of the arc through which the pendulum ascended in each experiment was measured by a ribbon, according to the method invented and described by Mr. Robins.

The recoil was measured in the following manner: The barrel was suspended in an horizontal position (and nearly in a line with the center of the target) by two small pendulous rods 64 inches in length, and 25.6 inches asunder; which, being parallel to each other, and moving freely upon polished pivots, about the axes of their suspension, and upon two pair of trunnions that were fixed to the barrel, formed, together with the barrel, a compound pendulum; and from the lengths of the vibrations of this pendulum, the velocity with which the barrel began to recoil, or rather its greatest velocity, was determined.

But in order that the velocity of the recoil might not be too great, so as to endanger the apparatus, when large charges were made use of, it was found necessary to load the barrel with an additional weight of more than 40 lbs. of iron.

This additional weight of iron, which I shall call the *gun-carriage*, as it was so constructed as to serve as a carriage to the barrel, is composed of a bar of hammered iron 28 inches in length, 2.6 inches broad, and half an inch in thickness, which is bent in the middle of its length, in such a manner that its two flat sides or ends are parallel to each other, and distant asunder two inches. In the middle of this bar, where it is bent, is a hole in the form of an oblong square, which, receiving the end of the breech-pin, supports the lower end or breech of the barrel. The other end of the barrel is supported and confined in the following manner: A ring or hoop of iron, near half an inch thick, and two inches in diameter, is placed in a vertical position between the parallel sides of the bar and near its two ends, and firmly fixed to them by screws. The barrel, passing through the middle of this ring, is supported upon the ends of three screws, which, passing through the ring in different parts of its circumference, all point towards its center.

The carriage, together with the barrel, was suspended by the pendulous rods by means of two pair of polished trunnions, that are fixed to the outside of the carriage. They are placed in an horizontal line perpendicular to, and passing through, the axis of the bore.

Fig. 8 represents the barrel fixed to the carriage. *a*, *b*, *c*, is the bar of iron seen edgewise which forms the carriage.

2, 2, 4, 4, are the trunnions by which it was suspended.

d, e, is the barrel in its proper place.

p is the breech-pin, which, passing through a hole in the middle of the bar, *a, b, c*, supports the end *e* of the barrel; and

n is the ring that supports the end *d* of the barrel.

Fig. 9 represents a perpendicular section through the line 2, 2, Fig. 8, and in a line perpendicular to the length of the barrel.

This figure is designed to shew the manner in which the muzzle of the piece was supported and confined in the ring *n*, Fig. 8.

a, c, are the two ends of the bar that are seen cut off.

n is the ring, and

o, p, are the screws by which it is fastened to the two parallel sides of the bar, the ends of which screws form the trunnions 2, 2, Fig. 8.

d is a transverse section of the barrel, and

r, s, t, are the three screws by which the barrel is supported and confined in the center of the ring.

Fig. 10 is the same as Fig. 9, but upon a larger scale, and without the letters of reference.

Fig. 11 represents the two ends of one of the pendulous rods by which the barrel was suspended; and Fig. 13 shews the same seen sideways.

a, b, is the rod which is seen broken off.

c, d, are the pivots by which it was suspended by a pair of hooks that were fastened to an horizontal beam, in the same manner as the pendulum for measuring the velocities of the bullets was suspended.

e, f, are the hooks which receive the trunnions that are fixed to the carriage.

The dimensions of every part of this apparatus may be seen in the table, page 14.

The chord of the arc through which the barrel ascended in its recoil was measured by a ribbon, and the lengths of those chords, expressed in inches and decimal parts of an inch, are set down in the tables. The method of computing the velocity of the recoil from the chord of the arc through which the barrel ascended is too well known to require an explanation; and it is also well known that the velocities are to each other as the chords of those arcs. The lengths of those chords, therefore, as they are set down in the tables, are in all cases as the velocities of the recoil.

The powder made use of in these experiments was of the best kind, such as is used in proving great guns at Woolwich. A cartridge containing 12 lbs. of this powder was given to me by the late General Desaguliers, of the Royal Artillery, and Inspector of Brass and Iron Ordnance; who also, in the politest manner, offered me every other assistance in his power, towards completing the experiments I had projected, or in making any others I should propose, that might be useful in the prosecution of my inquiries.

This powder was immediately taken out of the cartridge and put into glass bottles, which were previously made very clean and dry; and in these it was kept carefully sealed up till it was opened for use. When it was wanted for the experiments, it was weighed out in a very exact balance, with so much attention, that there could not possibly be an error in any instance greater than one quarter part of a grain. The bottles were never opened but in fine weather, and in a room that was free from damp, and no more charges of powder than were neces-

sary for the experiments of the day were weighed out at a time. Each charge was carefully put up in a cartridge of very fine paper, and these filled cartridges were kept in a turned wooden box, that was varnished on the inside as well as the outside, to prevent its imbibing moisture from the air.

The paper of which these cartridges were made was so fine and thin, that 1,280 sheets of it made no more than an inch in thickness, and a cartridge capable of containing half an ounce of powder weighed but three quarters of a grain.

The cartridges were formed upon a wooden cylinder, and accurately fitted to the bore of the piece, and the edges of the paper were fastened together with paste made of flour and water.

When a cartridge was filled, the powder was gently shaken together, and its mouth was tied up and secured with a piece of fine thread; and when it was made use of, it was put intire into the piece, and gently pushed down into its place with the ram-rod, and afterwards it was pricked with a priming-wire thrust through the vent, and the piece was primed; so that no part of the powder of the charge was lost in the act of loading, as is always the case when the powder is put loose into the barrel; nor was any part of it expended in priming; but the whole quantity was safely lodged in the bottom of the bore or chamber of the piece, and the bullet was put down immediately upon it, without any wadding either between the cartridge and the bullet, or over the bullet.

The bullets were all cast in the same mould, and, consequently, could not vary in their weights above two or three grains at most, especially as I took care to bring the mould to a proper temperature as to heat, before I

began casting; and when leather was put about them, or other bullets than those of lead were made use of, the weight was determined very exactly before they were put into the piece.

The diameter of the bullet was determined by measurement, and also by computation, from its weight, and the specific gravity of the metal of which it was formed; and both these methods gave the same dimensions very nearly.

The apparatus was put up for making the experiments in a coach-house, which was found very convenient for the purpose, as the joists upon which the floor overhead was laid afforded a firm and commodious support for suspending the pendulum and the barrel, and the walls and roofs of the building served to screen the apparatus, which otherwise might have been disturbed by the wind, and injured by the rain and dews. A pair of very large doors, which formed the whole of one end of the room, were kept constantly open during the time the experiments were making, in order to preserve the purity of the air within the house, which otherwise would have been much injured by the smoke of the gunpowder, which might, possibly, have had some effect in lessening the force of the powder, and vitiating the experiments. In order still further to guard against this evil, the barrel was placed as near as possible to the door, and the pendulum was hung up at the bottom of the room.

Fig. 12 represents the apparatus as it was put up for making the experiments.

a, b, is the barrel with its carriage, suspended by the pendulous rods *c, d*, and

R is the ribbon which served to measure the ascending arc of its recoil.

P is the pendulum, and

r the ribbon that measured the arc of its vibration.

The distance from the mouth of the piece to the pendulum was just 12 feet.

A TABLE SHEWING THE WEIGHTS AND DIMENSIONS OF
ALL THE PRINCIPAL PARTS OF THE APPARATUS.

Of the Barrel.

	Inches.
Length	44.7
Length of the bore from the muzzle to the breech-pin	43.45
Diameter of the bore	0.78
Thickness of metal at the lower vent	0.36
Thickness of metal at the muzzle	0.1
Weight of the barrel, together with the solid breech-pin and the vent-screws and vent-tube, 6 lbs. 6 oz.	

Of the Gun-Carriage.

	Inches.
Length	28.4
Distance between the two pair of trunnions	25.6
Diameter of each trunnion	0.25
Weight, 40 lbs. 14 oz.	

Of the Rods by which the Carriage was suspended.

Length from the axis of suspension or center of the pivots, to the center of the trunnions of the gun-carriage	Inches. 64
Weight of each rod, 1 lb. 4 oz.	

Total weight of the barrel and its carriage, together with the allowance that was made for the weight of the rods by which it was suspended, 48 lbs.

N. B. — This was its weight from experiment No. 3 to experiment No. 123, inclusive.

Of the Bullet.

Diameter, 0.75 of an inch.
 Weight in lead, 580 grains.

Of the Pendulum.

Inches.

Total length of the pendulum from the axis of suspension to the bottom of the circular plate 69.5
 Diameter of the circular plate to which the targets were fastened 13.
 Distance between the shoulders of the pivots 3.8
 Diameter of the pivots27
 Weight of the iron part of the pendulum, 47 lbs. 4 oz.

Of the Pendulum with the Targets fixed to it, as it was prepared for making the Experiments.

		Distance from the Axis of Suspension.			Total Weight of Iron and Wood.	
		Total Length to the Ribbon.	To the Center of Gravity.	To the Center of Oscillation.	lbs.	oz.
		Inches.	Inches.	Inches.		
Pendulum	No. 1	69.25	50.25	58.45	57	0
"	No. 2	69.5	54.4	59.15	82	4
"	No. 3	55.62	60.23	100	12
"	No. 4	54.6	59.18	88	4

N. B. — The measure is English feet and inches, and the weight is avoirdupois.

Having now gone through with the description of all the principal parts of the apparatus, I shall proceed to give an account of the experiments; and as it may be satisfactory to see the method of conducting these en-

quiries as well as the result of them, I shall first give a table of the experiments in the exact order in which they were made, together with my original remarks; I shall then make such general observations as may occur; and afterwards I shall select, combine, and compare them, in the manner which may best answer the different purposes to which I shall apply them.

General Table of the Experiments.

In the two first experiments the barrel was fixed to a carriage (that has not been described), which, together with the barrel and rods by which it was suspended, weighed only $23\frac{1}{2}$ lbs.

Length of the bore of the piece, 43.5 inches.

Weight of the bullet, 580 grains.

The Pendulum No. 1.

Order of Experiments.	The Charge of Powder.		Vent from the Bottom of the Charge.	Chord of the ascending Arc of the Pendulum.	The Bullet struck the Target below the Axis of the Pendulum.	Chord of the Arc of the Recoil.	Velocity of the Bullet.	Remarks.
	Weight.	Height.						
No.	Grains.	Inches.	Inches.	Inches.	Inches.	Inches.	Feet in Seconds.	
1	208	1.8	0.	13.2	64.5	33.5	1267	<i>First day.</i>
25	14.5	...	36.5	1399	

This gun-carriage being found to be too light, the other, described above, and represented Fig. 8, was substituted in the room of it.

Order of Experiments.	The Charge of Powder.		Vent from the Bottom of the Charge.	Chord of the ascending Arc of the Pendulum.	The Bullet struck the Target below the Axis of the Pendulum.	Chord of the Arc of the Recoil.	Velocity of the Bullet.	Remarks.
	Weight.	Height.						
No.	Grains.	Inches.	Inches.	Inches.	Inches.	Inches.	Feet in Seconds.	
3	208	1.8	0.0	12.6	65.0	17.8	1213	<i>Second day.</i> { The pendulum gave way. { 4 bullets were fired at once. Ditto. Without any bullet. Ditto. { Pendulum No. 2 very fair third day. The powder was lighted by the long vent-tube (Fig. 4). { The barrel very much heated. { The short vent-tube (v, Fig. 3) was made use of.
4	0.5	18.5	...	
5	0.0	38.68	...	
6	0.5	38.48	...	
7	0.0	6.1	...	
8	416	3.6	16.5	...	
9	208	1.8	0.0	8.5	65.0	17.69	1281	
10	104	0.9	..	5.2	65.25	10.18	782	
11	310	2.7	0.0	9.6	64.6	24.69	1459	
12	1.22	10.1	65.0	24.95	1527	
13	2.65	11.85	64.75	24.9	1801	
14	10.9	65.25	..	1646	
15	330	2.9	2.65	10.9	61.5	26.2	1748	
16	13.25	63.5	..	2060	
17	330	2.7	2.65	12.7	...	
18	...	2.9	0.0	10.4	63.5	26.3	1619	
19	63.0	26.4	1633	
20	165	1.45	0.0	6.8	62.2	14.73	1084	
21	6.85	..	14.2	1093	
22	1.32	6.7	..	14.8	1071	
23	6.3	60.6	14.58	1035	
24	7.5	61.5	14.68	1142	

In order to determine how much of the force of the powder was lost by *windage*, and by the *vent*, oiled leather was fastened round the bullet, so that it now accurately fitted the bore of the piece; and in the five experiments, from No. 35 to No. 39, inclusive, the valve-vent was made use of.

Weight of the bullet, together with the leather in which it was enveloped, 603 grains.

Order of Experiments.	The Charge of Powder.		Vent from the Bottom of the Charge.	Chord of the ascending Arc of the Pendulum.	The Bullet struck the Target below the Axis of the Pendulum.	Chord of the Arc of the Recoil.	Velocity of the Bullet.	Remarks.
	Weight.	Height.						
No.	Grains.	Inches.	Inches.	Inches.	Inches.	Inches.	Feet in Seconds	
25	165	1.45	0.0	6.8	65.0	14.95	1004	<i>Fourth day.</i>
26	7.8	..	15.6	1153	
27	8.05	..	16.15	1192	
28	330	2.9	..	10.2	63.0	26.0	1559	
29	2.6	..	64.0	28.1	1536	
30	165	3.2	..	5.9	62.4	13.2	914	
31	...	1.45	1.3	6.65	62.6	15.15	1027	

Finding that the blast of the powder always reached as far as the pendulum, when large charges were used, and suspecting that this circumstance, together with the impulse of the unfired grains, might, in a great measure, occasion the apparent irregularity in the velocities of the bullets; to remedy these inconveniences, a large sheet of paper of a moderate thickness was stretched upon a square frame of wood, and interposed as a screen before the pendulum, at the distance of two feet from the surface of the target.

Two reasons conspired to induce me to prefer this method of preventing the impulse of the flame upon the pendulum, to the obvious one of removing the pendulum further from the mouth of the piece; the first was, that I was unwilling to increase the distance between the barrel and the pendulum, lest the resistance of the air might affect the velocities of the bullets; and the second, which I confess did not operate less strongly than the first, was that the length of the house did not

admit of a greater distance, and I was unwilling to expose any part of the apparatus in the open air.

But the screen was found to answer perfectly well the purpose for which it was designed, and it was continued during the remainder of the experiments; the paper being replaced every third or fourth experiment.

The Experiments continued.

Order of Experiments.	The Charge of Powder.		Vent from the Bottom of the Charge.	Chord of the ascending Arc of the Pendulum.	The Bullet struck the Target below the Axis of the Pendulum.	Chord of the Arc of the Recoil.	Velocity of the Bullet.	Remarks.
	Weight.	Height.						
No.	Grains.	Inches.	Inches.	Inches.	Inches.	Inches.	Feet in Seconds.	
32	165	1.45	0	5.45	63.	15.45	839	Not leathered: weight of the bullet and wad 603 grs. In exp. No. 32 no less than 40 grains of unfired powder were driven through the screen.
33	12.65	839	
34	7.9	..	15.45	1217	In these 6 experiments the bullets were leathered and the powder was lighted by the valve-vent.
35	7.	60.25	15.25	1129	
36	7.4	62.	16.3	1161	
37	1.3	8.	61.	17.9	1277	
38	290	2.6	2.6	9.	58.6	23.5	1497	
39	24.8	..	

The bullets were now put naked into the piece, and the powder was lighted by the short vent-tube (*v*, Fig. 3), and some little improvement was made in the steel edges between which the ribbons passed that served to measure the ascending arcs of the pendulum and of the recoil, by which means the friction was lessened, and the ribbon was prevented from twisting or entangling itself as it was drawn out.

Apparatus.

The barrel with its carriage as before. The pendulum No. 3, and leaden bullets weighing 580 grains each.

Experiments upon Gunpowder.

Order of Experiments.	The Charge of Powder.		Vent from the Bottom of the Charge.	Chord of the ascending Arc of the Pendulum.	The Bullet struck the Target below the Axis of the Pendulum.	Chord of the Arc of the Recoil.	Velocity of the Bullet.	Remarks.
	Weight.	Height.						
No.	Grains.	Inches.	Inches.	Inches.	Inches.	Inches.	Feet in Seconds.	
40	218	1.9	0	6.45	64.6	18.	1236	<i>Fifth Day.</i> Mean velocity in these experiments and No. 47, 1225. Mean velocity 1276. Mean velocity 1427. Mean velocity 1493. Mean velocity 1460. In these 4 experiments the piece was fired with powder alone, and the screen was taken away from before the pend.
41	6.31	65.3	17.71	1197	
42	6.45	65.	17.91	1230	
43	1.3	6.5	64.6	18.3	1248	
44	6.75	64.5	18.35	1299	
45	6.6	64.9	..	1265	
46	6.4	61.6	..	1293	
47	0	6.3	62.	18.1	1266	
48	290	2.6	0	7.2	63.5	22.58	1414	
49	7.4	..	22.92	1455	
50	7.3	64.6	22.38	1412	
51	290	2.6	1.3	7.4	63.	23.21	1476	
52	7.6	64.	23.76	1520	
53	7.25	61.	23.6	1483	
54	2.6	7.5	62.3	..	1502	
55	7.4	64.	23.26	1450	
56	7.1	62.2	..	1433	
57	7.4	64.	23.56	1454	
58	1.31	..	11.12	—	
59	1.2	..	11.62	—	
60	0	1.16	..	9.62	—	
61	1.3	0.6	..	11.33	—	
62	330	2.9	1.3	8.	63.	26.4	1599	<i>Sixth Day.</i> Mean velocity 1625. Mean velocity 1528. Mean velocity 1594. Powder was ram'd very hard. Ditto much harder. Ditto as hard as in No. 68. Ditto, Ditto. Gov. pow. no bullet. Best double battle powder. Government powder. Double battle pow.
63	8.5	65.	..	1652	
64	2.6	7.2	59.5	25.3	1562	
65	7.7	65.	..	1495	
66	0	8.4	..	26.35	1633	
67	8.	..	25.8	1556	
68	218	1.9	0	6.82	64.	19.56	1349	
69	6.6	64.6	18.2	1294	
70	6.85	..	19.12	1345	
71	1.3	5.5	..	16.33	1080	
72	0	—	—	8.72	—	
73	—	—	8.44	—	
74	1.3	—	—	8.47	—	
75	—	—	9.3	—	

The following experiments, Nos. 78, 79, 80, and 81, were made in hopes of being able to discover a method of adding to the force of gunpowder. *Twenty grains* of the substances mentioned in the remarks upon each experiment were intimately mixed with the powder of the charge. In the experiment No. 82 a large wad of tow, well soaked in ethereal spirit of turpentine, was put into the piece immediately upon the bullet; and in the experiment No. 83 a wad, soaked in alcohol, was put into the piece in like manner.

Order of Experiments.	The Charge of Powder.		Vent from the Bottom of the Charge.	Chord of the ascending Arc of the Pendulum.	The Bullet struck the Target below the Axis of the Pendulum.	Chord of the Arc of the Recoil.	Velocity of the Bullet.	Remarks.
	Weight.	Height.						
No.	Grains.	Inches.	Inches.	Inches.	Inches.	Inches.	Feet in Seconds.	
76	145	1.3	0	5.3	65.	13.25	1037	<i>Seventh Day.</i> } Medium vel. 1040. { 20 grs. best alkaline salt of tartar. { 20 grains æthiops mineral. { 20 grs. sal. ammon. { 20 grs. fine brass dust.
77	64.6	13.25	1044	
78	3.2	..	8.92		
79	4.35	..	11.68		
80	3.3	63.6	9.83		
81	4.2	63.4	11.45		
82	—	—	15.25	—	{ The screws which held the hooks by which the pendulum was suspended gave way, and the pendulum came down.
83	—	—	14.35	—	

In the nine following experiments, *viz.* from No. 84 to No. 92, inclusive, the valve-vent was made use of, and the bullets were made to fit the bore of the piece very exactly by means of oiled leather, which was so firmly fastened about them that in each experiment it entered the target with the bullet.

The bullet made use of in experiment No. 85 was of wood.

Those used in the experiments No. 86 and No. 87 were formed in the following manner: a small bullet was cast of plaister of Paris, which, being thoroughly dried and well heated at the fire, was fixed in the center of the mould that served for casting all the leaden bullets used in these experiments; and melted lead being poured into this mould, the cavity that surrounded the small plaister bullet was intirely filled up, and a bullet was produced, which to the eye had every appearance of solidity, but was as much lighter than a solid leaden bullet of the same diameter as the small plaister bullet was lighter than a leaden bullet of the same size.

In the experiments No. 88 and No. 89 solid leaden bullets were made use of. In the experiment No. 90 *two* bullets were discharged at once; in the experiment No. 91 *three*, and in the experiment No. 92 *four* were used.

In each of these experiments a fresh sheet of paper was made use of as a screen to the pendulum, in order that the velocities of the bullets might be measured more accurately; and also that the quantity of unfired powder might be estimated with greater precision.

Order of Experiments.	The Charge of Powder.		Vent from the Bottom of the Charge.	Weight of the Bullet.	Chord of the ascending Arc of the Pendulum.	The Bullet struck the Target below the Axis of the Pendulum.	Chord of the Arc of the Recoil.	Velocity of the Bullet.	Remarks.
	Weight.	Height.							
No.	Grains.	Inches.	Inches.	Grains.	Inches.	Inches.	Inches.	Feet in Seconds.	
84	145	1.3	0	—	—	—	4.5	—	<i>Eighth Day.</i> In each of these 4 experiments from 50 to 70 granulae or particles of unfired powder were driven through the screen. Very few unfired grains of powder struck the screen. There were no marks of any unfired powder having reached the screen.
85	90	1.33	62.2	7.16	1763	
86	251	2.82	63.2	9.62	1317	
87	354	3.32	61.2	11.3	1136	
88	600	6.5	65.4	15.22	1229	
89	603	6.3	64.6	15.13	1229	
90	1184	10.12	65.	21.92	978	
91	1754	13.65	63.4	27.18	916	
92	2352	16.55	63.3	32.25	833	

In the seven following experiments the piece was fired with powder only.

Order of Experiments.	The Charge of Powder.		Vent from the Bottom of the Charge.	Chord of the ascending Arc of the Pendulum.	Chord of the Arc of the Recoil.	Remarks.
	Weight.	Height.				
No.	Grains.	Inches.	Inches.	Inches.	Inches.	
93	145	1.3	0	—	4.3	{ The screen was taken away. { The whole surface of the target was bespattered with unfired grs. of powder. { The pendulum was not observed.
94	165	1.45	..	—	5.5	
95	—	5.6	
96	290	2.6	..	—	11.70	
97	437½	3.9	..	1.68	17.5	
98	6.7	15.88	
99	—	17.9	

In the following experiments, No. 100 and No. 101, the bullets were not put down into the bore, but were supported by three wires, which being fastened to the end of the barrel projected beyond it, and confined the bullet in such a situation that its center was in a line with the axis of the bore, and its hinder-part was one twentieth of an inch without or beyond the mouth of the piece.

In experiment No. 102 the bullet was just stuck into the barrel in such a manner that near one half of it was without the bore.

Order of Experiments.	The Charge of Powder.		Vent from the Bottom of the Charge.	Chord of the ascending Arc of the Pendulum.	The Bullet struck the Target below the Axis of the Pendulum.	Chord of the Arc of the Recoil.	Velocity of the Bullet.	Remarks.
	Weight.	Height.						
No.	Grains.	Inches.	Inches.	Inches.	Inches.	Inches.	Feet in Seconds	
100	165	1.45	0	.65	60.5	4.9	138	In each of these experiments near one-tenth part of the substance of the bullet was melted and blown away by the impulse of the flame.
10143	Uncertain.	4.8	92	
10286	63.	5.6	180	

All that part of the bullet which lay towards the bore of the piece appeared to be quite flat from the loss of substance it had sustained; and its surface was full of small indents, which, probably, were occasioned by the unfired grains of powder that impinged against it.

The following experiments were made with the pendulum No. 4. The rest of the apparatus as before.

Order of Experiments.	The Charge of Powder.		Vent from the Bottom of the Charge.	Chord of the ascending Arc of the Pendulum.	The Bullet struck the Target below the Axis of the Pendulum.	Chord of the Arc of the Recoil.	Velocity of the Bullet.	Remarks.
	Weight.	Height.						
No.	Grains.	Inches.	Inches.	Inches.	Inches.	Inches.	Feet in Seconds.	
103	104	.9	0	4.51	65.	10.6	732	<i>Ninth Day.</i> { About 40 grains of powder were driven through the screen. { About 40 unfired grains of powder. { Mean velocity 894. { 40 unfired grains. { Double proof battle powder; no unfired grains. { Ditto, Ditto. { Government powder, bulletleathered; weight 602 grains. { Bullet naked; { very few unfired gr. { Mean velocity 1444. { Medium veloc. 1413. { Double proof battle powder. { Gov. } { No unfired { pow. } { grs. through { } { the screen { } { Mean vel. 1764. { Mean velocity 1751. { Without any bullet.
104	145	1.3	..	5.4	..	12.92	877	
105	5.6	..	13.28	910	
106	..	1.14	..	6.18	65.8	14.3	990	
107	218	1.8	..	8.48	65.	19.68	1380	
108	290	2.6	..	9.45	65.6	23.9	1526	
109	8.73	65.2	22.8	1419	
110	9.3	65.6	23.4	1460	
111	1462	
112	8.85	65.5	22.94	1436	
113	2.6	8.65	64.	23.7	1438	
114	8.5	63.6	24.1	1423	
115	8.4	65.	23.8	1378	
116	..	2.28	..	9.15	64.	24.6	1525	
117	437½	3.9	..	10.55	64.9	33.	1738	
118	11.	64.5	33.3	1824	
119	10.5	65.	33.6	1729	
120	2.6	10.35	..	32.5	1706	
121	10.65	..	33.2	1757	
122	10.6	63.6	32.9	1789	
123	0	—	—	17.9	—	

Of the Method made Use of for computing the Velocities of the Bullets.

As the method of computing the velocity of a bullet from the arc of the vibration of a pendulum into which it is fired is so well known, I shall not enlarge upon it in this place, but shall just give the theorems that have been proposed by different authors, and shall refer those

who wish to see more on the subject to Mr. Robins's *New Principles of Gunnery*; to Professor Euler's *Observations upon Mr. Robins's Book*; and lastly, to Dr. Hutton's Paper on the initial Velocities of Cannon Balls, published in the *Transactions of the Royal Society*, for the year 1778.

If a denote the length from the axis of the pendulum to the ribbon which measures the chord of the arc of its vibration;

g the distance of the center of gravity below the axis of the pendulum;

f the distance of the center of oscillation; and

h the distance of the point struck by the bullet from that axis;

c the chord of the ascending arc of the pendulum;

P the weight of the pendulum;

b the weight of the bullet, and

v the original velocity of the bullet;

$$v = \frac{c}{a} \times \frac{Pg}{bh} + \frac{h}{f} \times \frac{f}{\sqrt{2h}}$$

is a theorem for finding the velocity upon Mr. Robins's principles.

$$* v = \frac{c}{a} \times \frac{Pg}{bh} + \frac{f+h}{2f} \times \sqrt{\frac{f}{2}}$$

is the theorem proposed by Professor Euler, who has corrected a small error in Mr. Robins's method; and

$$v = 5.672 \ cg \ \sqrt{f} \times \frac{P+b}{bha}$$

* Put the rational part $\frac{c}{a} \times \frac{Pg}{bh} + \frac{f+h}{2f} = n$ and express f in thousandth parts of a Rhymland foot; then the velocity with which the ball strikes the pendulum will be $= \frac{n}{4} \sqrt{\frac{f}{2}}$ Rhymland feet in a second.

is Dr. Hutton's theorem, which is sufficiently accurate, and far more simple and expeditious than either of the preceding. It is to be remembered that g , h , and c may be expressed in any measure; but f must be English feet, and v will be the velocity of the bullet in English feet in a second.

The velocities of the bullets in most of the foregoing experiments were first computed by Euler's method, as I had not then seen Dr. Hutton's paper; but in going over the calculations a second time, I made use of Dr. Hutton's theorem. Both these methods gave the same velocity very nearly, but the Doctor's method is by much the easiest in practice.

In these computations care was taken to make a proper allowance for the bullets that were lodged in the pendulum, and also for the velocity lost by the bullet in passing through the screen.

The corrections necessary on account of the bullets lodged in the pendulum were made in the following manner: —

b was continually added to the value of P ,

$\frac{h-g}{P} \times b$	“	“	“	to the value of g , and
$\frac{f-h}{P} \times b$	“	“	“	to the value of f .

Of the Spaces occupied by the different Charges of Powder.

The heights of the charges of powder, or the lengths of the spaces which they occupied in the bore, were determined by measurement; and in order that this might be done with greater accuracy, inches and tenths of inches were marked upon the ramrod, and the charge

was gently forced down till it occupied the same space in each experiment.

The following table shews the heights of the charges as they were determined by measurement, and also their heights computed from the diameter of the bore of the piece, and the specific gravity of the powder that was used.

N. B. — By an experiment, of which I shall give an account hereafter, I found the specific gravity of this powder, shaken well together, to be to that of rain-water as 0.937 is to 1.000.

Weight of the Powder.	Height of the Charge.	
	Measured.	Computed.
Grains.	Inches.	Inches.
104	.9	0.8957
145	1.3	1.2490
165	1.45	1.4211
208	1.8	1.7914
218	1.9	1.8775
290	2.6	2.4980
310	2.7	2.6700
330	2.9	2.8422
416	3.6	3.5828
437½	3.9	3.7680

In the experiment No. 30 the powder was put into a cartridge so much smaller than the bore of the piece that the charge, instead of occupying 1.45 inches, extended 3.2 inches. By this disposition of the powder, its action upon the bullet appears to have been very much diminished.

Of the Effect that the Heat which Pieces acquire in being fired produces upon the Force of Powder.

It is very probable that the excess of the velocity of the bullet in the second experiment over that of the

first was occasioned more by the heat which the barrel had acquired in the first experiment than by the position of the vent, or any other circumstance; for I have since found, upon repeated trials, that the force of any given charge of powder is considerably greater when it is fired in a piece that has been previously heated by firing, or by any other means, than when the piece has not been heated. Everybody that is acquainted with artillery knows that the recoil of great guns is much more violent after the second or third discharge than it is at first; and on shipboard, where it is necessary to attend to the recoil of the guns, in order to prevent very dangerous accidents that might be occasioned by it, the constant practice has been in our navy, and I believe on board the ships of all other nations, to lessen the quantity of powder after the first four or five rounds; our 32 pounders, for instance, are commonly fired with 14 lbs. of powder at the beginning of an action, but the charge is very soon reduced to 11 lbs., and afterwards to 9 lbs., and the filled cartridges are prepared accordingly.

By the recoil, it should seem that the powder exerted a greater force also in the fourth experiment, being the second upon the second day, than it did upon the third, or the first upon that day; but, the pendulum giving way, it was not possible to compare the velocities of the bullets in the manner we did in the two experiments mentioned above.

This augmentation of the force of powder, when it is fired in a piece that is warm, may be accounted for in the following manner. There is no substance we are acquainted with that does not require to be heated before it will burn; even gunpowder is not inflammable

when it is cold. Great numbers of sparks, or red-hot particles from the flint and steel are frequently seen to light upon the priming of a musket, without setting fire to the powder, and grains of powder may be made to pass through the flame of a candle without taking fire; and what is still more extraordinary, if large grains of powder are let fall from the height of two or three feet upon a red-hot plate of iron, laid at an angle of about 45° with the plane of the horizon, they will rebound intire, without being burnt, or in the least altered by the experiment. In all these cases the fire is too feeble, or the duration of its action is not sufficiently long to heat the powder to that degree which is necessary in order to its being rendered inflammable.

Now as gunpowder, as well as all other bodies, acquires heat by degrees, and as some space of time is taken up in this, as well as in all other operations, it follows that powder which has been warmed by being put into a piece made hot by repeated firing is much nearer that state in which it will burn, or, I may say, is more inflammable, than powder which is cold; consequently, more of it will take fire in a given short space of time, and its action upon the bullet and upon the gun will, of course, be greater.

The heat of the piece will also serve to dry the air in the bore, and to clear the inside of the gun of the moisture that collects there when it has not been fired for some time; and these circumstances doubtless contribute something to the quickness of the inflammation of the powder, and consequently to its force.

As it takes a longer time to heat a large body than a small one, it follows that meal-powder is more inflammable than that which is grained; and the smaller the

particles are, the quicker they will take fire. Sailors bruise the priming after they have put it to their guns, as they find it very difficult, without this precaution, to fire them off with a match; and if those who are fond of sporting would make use of a similar artifice, and prime their pieces with meal-powder, they would miss fire less often, — the springs of the lock might be made more tender, and its size considerably reduced without any risque, and, the violence of the blow of the flint and steel in striking fire being lessened, the piece might be fired with greater precision.

Concluding from the results of the four experiments mentioned above, as well as from the reasons just cited, that the temperature of the piece has a considerable effect upon the force of the powder, I afterwards took care to bring the barrel to a proper degree of heat by firing it once or oftener with powder, each time I recommenced the experiments after the piece had been left to cool.

Of the Manner in which Pieces acquire Heat in firing.

I was much surprised upon taking hold of the barrel immediately after the experiment No. 17, when it was fired with 330 grains of powder without any bullet, to find it so very hot that I could scarcely bear it in my hand, evidently much hotter than I had ever observed it before, notwithstanding the same charge of powder had been made use of in the two preceding experiments, and in both these experiments the piece was loaded with a bullet, which, one would naturally imagine, by confining the flame and prolonging the time of its action, would heat the barrel much more than when it was fired with powder alone.

I was convinced that I could not be mistaken in the fact, for it had been my constant practice to take hold of the piece to wipe it out as soon as an experiment was finished, and I never before had found any inconvenience from the heat in holding it. But in order to put the matter beyond all doubt, after letting the barrel cool down to the proper temperature, I repeated the experiment twice, with the same charge of powder and a bullet; and in both these trials (experiments No. 18 and No. 19), the heat of the piece was evidently much less than what it was in the experiment above mentioned (No. 17).

I now regretted exceedingly the loss of a small pocket thermometer, which I had provided on purpose to measure the heat of the barrel, but it was accidentally broken by a fall the day before I began my experiments; and, being so far from London, I had it not in my power to procure another; I was, therefore, obliged to content myself with determining the heat of the barrel as well as I could by the touch.

Being much struck with this accidental discovery of the great degree of heat that pieces acquire when they are fired with powder without any bullet, and being desirous of finding out whether it is a circumstance that obtains universally, I was very attentive to the heat of the barrel after each of the succeeding experiments; and I constantly found the heat sensibly greater when the piece was fired with powder only than when the same charge was made to impel one or more bullets.

Though the result of these experiments was totally unexpected, and even contrary to what I should have foretold, if I had been asked an opinion upon the subject previous to making them, yet, after mature con-

sideration, I am now convinced that it is what ought to happen, and that it may be accounted for very well, upon principles that are clearly admissible.

It is certain that a very small part only of the heat that a piece of ordnance acquires in being fired is communicated to it by the flame of the powder, for the time of its action is so short (not being, perhaps, in general, longer than about $\frac{1}{200}$ th or $\frac{1}{150}$ th part of a second) that if its heat, instead of being 4 times, as Mr. Robins supposes, was 400 times hotter than red-hot iron, it could not sensibly warm so great a mass of metal as goes to form one of our large pieces of cannon. And besides, if the heat of the flame were sufficiently intense to produce so great an effect in so short a time, it would certainly be sufficient, not only to burn up all inflammable bodies that it came near, but also to melt the shot that it surrounded and impelled, especially when they were small, and composed of lead, or any other fusible metal; but so far from this being the case, we frequently see the finest paper come out of the mouth of a piece uninflamed, after it has sustained the action of the fire through the whole of the bore, and the smallest lead shot is discharged without being melted.

But it may be objected here, that the bullets are always found to be very hot, if they are taken up immediately after they come out of a gun; and that this circumstance is a proof of the intensity of the heat of the flame of powder, and of its great power of communicating heat to the densest bodies. But to this I answer, I have always observed the same thing of bullets discharged from wind-guns and cross-bows, especially when they have impinged against any hard body,

and are much flattened ; and bullets from muskets are always found to be hotter in proportion to the hardness of the body against which they are fired. If a musket-ball be fired into a very soft body, as (for instance) into water, it will not be found to be sensibly warmed ; but if it is fired against a thick plate of iron, or any other body that it cannot penetrate, the bullet will be demolished by the blow, and the pieces of it that are dispersed about will be found to be in a state very little short of fusion, as I have often found by experience. It is not by *the flame*, therefore, that bullets are heated, but by percussion. They may indeed receive some small degree of warmth from the flame, and still more perhaps by friction against the sides of the bore, but it is in striking against hard bodies, and from the resistance they meet with in penetrating those that are softer, that they acquire by far the greater part of the heat we find in them as soon as they come to be at rest, after having been discharged from a gun.

There is another circumstance that may possibly be brought as an objection to this opinion, and that is, the running of the metal in brass guns upon repeatedly firing them, by which means the vent is often so far enlarged as to render the piece intirely useless. But this, I think, proves nothing but that brass is very easily corroded and destroyed by the flame of the gunpowder ; for it cannot be supposed that in these cases the metal is ever fairly melted. The vent of a musket is very soon enlarged by firing, and after a long course of service, it is found necessary to stop it up with a solid screw, through the center of which a new vent is made of the proper dimensions. This operation is called bushing, or rather bouching, the piece ; but in

all the better kind of fowling-pieces the vent is lined or bouched with gold, and they are found to stand fire for any length of time without receiving the least injury. But everybody knows that gold will run with a less heat than is required to melt iron; but gold is not liable to be corroded by anything that can be produced in the combustion of gunpowder; but this is not the case with iron, and that I take to be the only reason why a vent that is lined with gold is so much more durable than one that is made in iron. But it seems that iron is more durable than brass; and perhaps steel or some other cheap metal may be found that will supply the place of gold, and by that means the great expence that attends bouching pieces with that precious metal may be spared, and this improvement may be introduced into common use.

This leads us to a very easy and effectual remedy for that defect so long complained of in all kinds of brass ordnance, *the running of the vent*; for if these pieces were bouched with iron, there is no doubt but they would stand fire as well as iron guns; and if steel, or any other metal, either simple or compounded, should, upon trial, be found to answer for that purpose better than iron, it might be used instead of it; and even if gold were made use of for lining the vent, I imagine it might be done in such a manner as that the expence would not be very considerable, at the same time that the thickness of the gold should be sufficient to withstand the force of the flame for a very great length of time.

But to return to the heat acquired by guns in firing. It being pretty evident that it is not *all* communicated by the flame, there is but one other cause to which it

can be attributed, and that is the *motion* and *friction* of the internal parts of the metal among themselves, occasioned by the sudden and violent effort of the powder upon the inside of the bore, and to this cause I imagine the heat is principally, if not almost intirely, owing. It is well known that a very great degree of heat may be generated in any hard and dense body in a short time by friction, and in a still shorter time by collision. "For if two dense, hard, elastic bodies be struck against each other with great force and velocity, all the parts of such bodies will every moment be closely compressed, and, being rigid, will react with equal force. Hence, a quick and powerful contraction and expansion will arise in every part, resembling that swift kind of vibration observed in stretched strings; how great these vibrations are may be learnt from the instance of a bell when struck with a single blow, by which the whole bulk, however vast, will for a long time expand and contract itself in infinite ellipses. And when the attrition above described is produced, with what force and velocity are all the particles of the rubbed body compressed, shaken, and loosened to their very intimate substance!"* And in proportion to the swiftness of this vibration, and the violence of the attrition and friction, will be the heat that is produced.

A piece of iron that would sustain the pressure of any weight, however large, without being warmed, may be made quite hot by the blow of a hammer; and even soft and un-elastic bodies may be warmed by percussion, provided the velocity with which their parts are made to give way to the blow is sufficiently rapid. If a leaden bullet be laid upon an anvil, or on any other hard body,

* Vide Shaw's Translation of Boerhave's Chemistry, vol. i. p. 249.

and in that situation be struck with a smart blow of the hammer, it will be found to be much heated; but the same bullet, in the same situation, may be much more flattened by pressure, or by the stroke of a very heavy body moving with a small velocity, without being sensibly warmed.

To generate heat, therefore, the action of the powder on the inside of the piece must not only be sufficient to *strain the metal*, and produce a motion in its parts, but this effect must be *extremely rapid*; and the heat will be much augmented if the exertion of the force and the duration of its action are momentaneous; for in that case the fibres of the metal (if I may use the expression) that are violently stretched will return with their full force and velocity, and the swift, vibratory motion and attrition before described will be produced.

The heat generated in a piece by firing is, therefore, as the force by which the particles of the metal are strained and compressed, the suddenness with which this force is exerted, and the shortness of the time of its action; that is to say, as the strength of the powder and the quantity of the charge, the quickness of its inflammation, and the velocity with which the generated fluid makes its escape.

Now the effort of any given charge of powder upon the gun is very nearly the same, whether it be fired with a bullet or without a bullet; but the velocity with which the generated elastic fluid makes its escape is much greater when the powder is fired alone than when it is made to impel one or more bullets; the *heat* ought, therefore, to be greater in the former case than in the latter, as I found it to be by experiment.

But to make this matter still plainer, we will suppose

any given quantity of powder to be confined in a space that is just capable of containing it, and that, in this situation, it is by any means set on fire. Let us suppose this space to be the chamber of a piece of ordnance of any kind, and that a bullet or any other solid body is so firmly fixed in the bore, immediately upon the charge, that the whole effort of the powder shall not be able to remove it. As the powder goes on to be inflamed, and the elastic fluid is generated, the pressure upon the inside of the chamber will be increased, till at length, all the powder being burnt, the strain upon the metal will be at its greatest height, and in this situation things will remain, the cohesion or elasticity of the particles of metal counterbalancing the pressure of the fluid.

Under these circumstances very little heat would be generated; for the continued effort of the elastic fluid would approach to the nature of the pressure of a weight; and that *concussion*, *vibration*, and *friction* among the particles of the metal, which in the collision of elastic bodies is the cause of the heat that is produced, would scarcely take effect.

But, instead of being firmly fixed in its place, let the bullet now be moveable, but let it give way with great difficulty, and by slow degrees. In this case the elastic fluid will be generated as before, and will exert its whole force upon the chamber of the piece; but as the bullet gives way to the pressure, and moves on in the bore, the fluid will expand itself and grow weaker, and the particles of the metal will gradually return to their former situations; but the velocity with which the metal restores itself being but small, the *vibration* that remains in the metal, after the elastic fluid has made its

escape, will be very languid, as will be the *heat* that is generated by it.

But if, instead of giving way with so much difficulty, the bullet be much lighter, so as to afford but little resistance to the elastic fluid in making its escape, or if the powder be fired without any bullet at all, then, there being little or nothing to oppose the flame in its passage through the bore, it will expand itself with an amazing velocity, and its action upon the gun will cease almost in an instant, the strained metal will restore itself with a very rapid motion, and a sharp vibration will ensue, by which the piece will be *much heated*.

Of the Effect of ramming the Powder in the Chamber of the Piece.

The charge, consisting of 218 grains of powder, being put gently into the bore of the piece in a cartridge of very fine paper without being rammed, the velocity of the bullets at a mean of the 40th, 41st, 42d, and 47th experiments was at the rate of 1225 feet in a second; but in the 68th, 69th, and 70th experiments, when the same quantity of powder was rammed down with five or six hard strokes of the ramrod, the mean velocity was 1329 feet in a second. Now the total force or pressure exerted by the charge upon the bullet is as the square of its velocity, and 1329^2 is to 1225^2 as 1.1776 is to 1, or nearly as 6 is to 5; and in that proportion was the force of the given charge of powder increased by being rammed.

In the 71st experiment the powder was also rammed, but the vent, instead of being at the bottom of the bore, was at 1.3, and the velocity of the bullet was very considerably diminished, being only at the rate of 1080

feet in a second, instead of 1276 feet in a second, which was the mean velocity with this charge and with the vent in this situation when the powder was rammed. See the experiments No. 43, 44, 45, and 46.

When, instead of ramming the powder or pressing it gently together in the bore, it is put into a space larger than it is capable of filling, the force of the charge is thereby very sensibly lessened, as Mr. Robins and others have found by repeated trials. In my 30th experiment the charge, consisting of no more than 165 grains of powder, was made to occupy 3.2 inches of the bore, instead of 1.45 inches, which space it just filled when it was gently pushed into its place without being rammed; the consequence was, the velocity of the bullet, instead of being 1100 feet in a second, or upwards, was only at the rate of 914 feet in a second, and the recoil was lessened in nearly the same proportion.

And from hence we may draw this practical inference, that the powder with which a piece of ordnance or a fire arm is charged ought always to be pressed together in the bore; and if it be rammed to a certain degree, the velocity of the bullet will be still farther increased. It is well known that the recoil of a musket is greater when its charge is rammed than when it is not; and there cannot be a stronger proof that ramming increases the force of the powder.

Of the Relation of the Velocities of Bullets to the Charges of Powder by which they are impelled.

It appears by all the experiments that have hitherto been made upon the initial velocities of bullets, that when the weights and dimensions of the bullets are the same, and they are discharged from the same piece by

different quantities of powder, the velocities are nearly in the sub-duplicate ratio of the weights of the charges.

The following table will shew how accurately this law obtained in the foregoing experiments : —

Charges.	Velocities.		Difference.	No. of Exp.
	Computed.	Actual.		
437½	1764	1764	0	3
330	1533	1594	+ 61	2
310	1486	1459	— 27	1
290	1436	1436	0	7
218	1232	1225	— 7	4
208	1216	1256	+ 40	3
165	1083	1087	+ 4	2
145	1018	1040	+ 22	2
104	860	757	—103	2

The computed velocities as they are set down in this table were determined from the ratio of the square root of 437½—the weight, in grains, of the largest charge of powder—to the mean velocity of the bullet with that charge and the vent at 0, *viz.*, 1764 feet in a second, and the square root of the other charges expressed in grains. And the *actual* velocities are means of all experiments that were made under similar circumstances with the given charges.

The fourth column shews the difference of the computed and actual velocities, or the number of feet in a second by which the actual velocity exceeds or falls short of the computed; and in the fifth column is set down the number of experiments with each charge from the mean of which the actual velocity was determined.

The agreement of the computed and actual velocities will appear more striking if we take the sum and differ-

ence of those velocities with all the charges except the first, thus : —

Sum of the Velocities — 1764.		Difference.	No. of Exp.
Computed.	Actual.		
9864	9854	— 10	23

So that it appears that the difference or the actual velocity was smaller than the computed by $\frac{1}{985}$ part only, at a mean of 23 experiments.

But as by far the greater number of the experiments were made with the following charges, *viz.*, 290, 218, 208, 165, and 145 grains of powder, let us take the sum and difference of the computed and actual velocities of those charges, thus : —

Sum of the Velocities.		Difference.	No. of Exp.
Computed.	Actual.		
5985	6044	+ 59	18

Here the agreement of the theory with the experiments is so very remarkable that we must suppose it was in some measure accidental; for the difference of the velocities in repeating the same experiment is, in general, much greater than the difference of the computed and actual velocities in this instance; but I think we may fairly conclude, from the result of all these trials, that the velocities of like *musket*-bullets, when they are discharged from the same piece by different quantities of the same kind of powder, are very nearly in the sub-duplicate ratio of the weights of the charges. Whether this law will hold good when applied to cannon-balls, and bomb-shells of large dimensions, I dare not at present take upon me to decide; but for several reasons that might be mentioned, I am rather of opinion that it will not; at least not with that degree of accuracy which obtained in these experiments.

Of the Effect of placing the Vent in different Parts of the Charge.

There have been two opinions with respect to the manner in which gunpowder takes fire. Mr. Robins supposes that the progress of its inflammation is so extremely rapid "that all the powder of the charge is fired and converted into an elastic fluid before the bullet is sensibly moved from its place"; while others have been of opinion that the progress of the inflammation is much slower, and that the charge is seldom or never completely inflamed before the bullet is out of the gun.

The large quantities of powder that are frequently blown out of fire-arms uninflamed seem to favour the opinion of the advocates for the gradual inflammation; but Mr. Robins endeavors to account for that circumstance upon different principles; and supports his opinion by shewing that every increase of the charge, within the limits of practice, produces a proportional increase of the velocity of the bullet; and that when the powder is confined by a great additional weight, by firing two or more bullets at a time, instead of one, the velocity is not sensibly greater than it ought to be, according to his theory.

If this were a question merely speculative, it might not be worth while to spend much time in the discussion of it; but as it is a matter upon the knowledge of which depends the determination of many important points respecting artillery, and from which many useful improvements may be derived, too much pains cannot be taken to come at the truth. Till the manner in which powder takes fire and the velocity with which the inflammation is propagated are known, nothing can with

certainly be determined with respect to the best form for the chambers of pieces of ordnance, or the most advantageous situation for the vent; nor can the force of powder, or the strength that is required in different parts of the gun, be ascertained with any degree of precision.

As it would be easy to determine the best situation for the vent from the velocity of the inflammation of powder being known, so, on the other hand, I had hopes of being able to come at that velocity by determining the effect of placing the vent in different parts of the charge; for which purpose the following experiments were made:—

A Table of Experiments shewing the Effect of placing the Vent in different Parts of the Charge.

Weight of the Charge of Powder.	Space occupied by the Powder.	Vent from the Bottom of the Bore.	Velocity of the Bullet at a Medium.	Recoil measured upon the Ribbon at a Medium.	No. of Exp.
Grains.	Inches.	Inches.	Feet in a Sec.	Inches.	
165	1.45	0	1087	14.465	2
...	...	1.32	1082	14.31	3
218	1.9	0	1225	17.93	4
...	...	1.3	1276	18.34	4
290	2.6	0	1427	22.626	3
...	...	1.3	1493	23.34	3
...	...	2.6	1460	23.286	4
...	...	0	1444	23.135	4
...	...	2.6	1413	24.5	3
310	2.7	0	—	24.69	1
...	...	1.32	—	24.95	1
...	...	2.65	—	24.9	1
330	2.9	0	1594	26.075	2
...	...	1.3	1625	26.4	2
...	...	2.6	1525	25.3	2
437½	3.9	0	1764	33.3	3
...	...	2.6	1751	32.866	3

By the foregoing experiments it appears that the difference in the force of any given charge of powder

which arises from the particular situation of the vent is extremely small.

With 165 grains of powder, and the vent at 0, the velocity of the bullet, at a mean of two experiments (*viz.* the 20th and 21st), was 1087 feet in a second; and with the same charge, and the vent at 1.32 inches, the velocity, at a mean of the 22d, 23d, and 24th experiments, was 1082 feet in a second; the difference (equal to five feet in a second) is less than what frequently occurred in a repetition of the same experiment.

With 218 grains of powder, and the vent at 0, the velocity, at a mean in the 40th, 41st, 42d, and 47th experiments, was at the rate of 1225 feet in a second; and with the same charge, and the vent at 1.3, the velocity was 1276 feet in a second, at a mean of four experiments, *viz.* the 43d, 44th, 45th, and 46th.

In the first set of experiments, with 290 grains of powder, the velocities were,

	Vent at 0.	Vent at 1.3.	Vent at 2.6.
	1414	1476	1502
	1455	1520	1450
	1412	1483	1433
	<hr style="width: 50%; margin: 0 auto;"/>	<hr style="width: 50%; margin: 0 auto;"/>	<hr style="width: 50%; margin: 0 auto;"/>
	3)4281	3)4479	4)5839
Means,	1427	1493	1460

See the experiments from No. 48 to No. 57, inclusive.

In the second set the velocities were,

	Vent at 0.	Vent at 2.6.
	1419	1438
	1460	1423
	1462	1378
	<hr style="width: 50%; margin: 0 auto;"/>	<hr style="width: 50%; margin: 0 auto;"/>
	4)5777	3)4239
Means,	1444	1413

See the experiments from No. 109 to No. 115, inclusive.

And taking the means of all the velocities in both sets in each position of the vent, it will be,

	Vent at o	Vent at 1.3.	Vent at 2.6.
Mean Velocity,	1436	1493	1437

The mean recoils in these experiments were,

Vent at o.	Vent at 1.3.	Vent at 2.6.
22.88	23.34	23.61

In the experiments with 310 grains of powder, the velocities of the bullets were not determined with sufficient accuracy to be depended on; but the recoils, which were measured with great nicety, were as follows, *viz.*

Vent at o.	Vent at 1.3.	Vent at 2.6.
24.69	24.95	24.9

With 330 grains of powder, the mean velocities and recoils were,

	Vent at o.	Vent at 1.3.	Vent at 2.6.
Velocities,	1594	1625	1525
Recoils,	26.075	26.4	25.3

In the experiments with $437\frac{1}{2}$ grains (an ounce avoirdupois) of powder, the velocities and recoils were,

	Vent at o.		Vent at 2.6.	
	Velocity.	Recoil.	Velocity.	Recoil.
	1738	33.	1707	32.5
	1824	33.3	1757	33.2
	1728	33.6	1789	32.9
	<u>3)5291</u>	<u>3)99.9</u>	<u>3)5253</u>	<u>3)98.6</u>
Means,	1764	33.3	1751	32.866

From the result of these experiments it appears that the effect of placing the vent in different positions with respect to the bottom of the chamber is different in different charges; thus, with 165 grains of powder, the

velocity of the bullet was rather diminished by removing the vent from 0, or the bottom of the bore, to 1.32; but with 218 grains of powder, the velocity was a little increased, as was also the recoil. With 290 grains of powder, the velocity was greatest when the powder was lighted at the vent 1.3, which was near the middle of the charge, and rather greater when it was lighted at the top, or immediately behind the bullet, than when it was lighted at the bottom. And by the recoil it would seem that the velocities of the bullets varied nearly in the same manner when the charge consisted of 310 grains of powder.

With 330 grains of powder, both the velocity and the recoil were greater when the powder was lighted at the middle of the charge than when it was lighted at the bottom; but they were least of all when it was lighted near the top. And when *an ounce* of powder was made use of for the charge, its force was greatest when it was lighted at the bottom. But the difference in the force exerted by the powder, which arose from the particular position of the vent, was in all cases so inconsiderable (being, as I have before observed, less than what frequently occurred in repeating the same experiment) that no conclusion can be drawn from the experiments except only this, that any given charge of powder exerts nearly the same force, whatever is the position of the vent.

And hence the following practical inference naturally occurs, *viz.* that in the construction of fire-arms no regard need be had to any supposed advantages that gunsmiths and others have hitherto imagined were to be derived from particular situations for the vent, such as diminishing the recoil, increasing the force of the charge,

&c.; but the vent may be indifferently in any part of the chamber where it will best answer upon other accounts; and there is little doubt but the same thing will hold good in great guns, and all kinds of heavy artillery.

Almost every workman who is at all curious in fire-arms has a particular fancy with regard to the best form for the bottom of the chamber, and the proper position of the vent. They, in general, agree that the vent should be as low or far back as possible, in order, as they pretend, to lessen the recoil; but no two of them make it exactly in the same manner. Some make the bottom of the chamber flat, and bring the vent out even with the end of the breech-pin. Others make the vent slanting through the breech-pin, in such a manner as to enter the bore just in its axis. Others again make the bottom of the chamber conical; and there are those who make a little cylindric cavity in the breech-pin of about two tenths of an inch in diameter, and near half an inch in length, coinciding with the axis of the bore, and bring out the vent even with the bottom of this little cavity.

The objection to the first method is, the vent is apt to be stopped up by the foul matter that adheres to the piece after firing, and which is apt to accumulate, especially in damp weather. The same inconvenience, in a still greater degree, attends the other methods, with the addition of another, arising from the increased length of the vent; for, the vent being longer, it is not only more liable to be obstructed, but it takes a longer time for the flame to pass through it into the chamber, in consequence of which the piece is slower in going off, or, as sportsmen term it, is apt to hang fire.

The form I would recommend for the bottom of the bore is that of a hemisphere, and the vent should be brought out directly through the side of the barrel, in a line perpendicular to its axis, and pointing to the center of the hemispheric concavity of the chamber. In this case the vent would be the shortest possible; it would be the least liable to be obstructed, and the piece would be more easily cleaned than if the bottom of the bore was of any other form. All these advantages, and several others not less important, would probably be gained by making the bottom of the bore and vent of great guns in the same manner.

A new Method of determining the Velocities of Bullets.

From the equality of *action* and *reaction*, it appears that the *momentum* of a gun must be precisely equal to the momentum of its charge; or that the weight of the gun, multiplied into the velocity of its recoil, must be in all cases just equal to the weights of the bullet and of the powder (or the elastic fluid that is generated from it), multiplied into their respective velocities: for every particle of matter, whether solid or fluid, that issues out of the mouth of a piece must be impelled by the action of some power, which power must *react* with equal force against the bottom of the bore.

Even the fine, invisible, elastic fluid that is generated from the powder in its inflammation cannot put itself in motion without reacting against the gun at the same time. Thus we see pieces, when they are fired with powder alone, recoil, as well as when their charges are made to impel a weight of shot, though the recoil is not in the same degree in both cases.

It is easy to determine the velocity of the recoil in

any given case by suspending the gun in an horizontal position by two pendulous rods, and measuring the arc of its ascent by means of a ribbon, according to the method already described; and this will give the momentum of the gun (its weight being known), and consequently the momentum of its charge. But in order to determine the velocity of the bullet from the recoil, it will be necessary to find out how much the weight and velocity of the elastic fluid contributes to produce that recoil.

That part of the recoil which arises from the expansion of this fluid is always very nearly the same, whether the powder is fired alone, or whether the charge is made to impel one or more bullets, as I have found by a great variety of experiments.

If therefore a gun, suspended according to the method prescribed, be fired with any given charge of powder, but without any bullet or wad, and the recoil be observed, and if the same piece be afterwards fired with the same quantity of powder and a bullet of a known weight, the excess of the velocity of the recoil in the latter case over that in the former will be proportional to the velocity of the bullet; for the difference of these velocities, multiplied into the weight of the gun, will be equal to the weight of the bullet multiplied into its velocity.

Thus, if W be put equal to the weight of the gun,

U = the velocity of its recoil, when it is fired with any given charge of powder, without any bullet,

V = the velocity of the recoil, when the same charge is made to impel a bullet,

B = the weight of the bullet, and

v = its velocity,

It will be
$$v = \frac{V - U + W}{B}.$$

Let us see how this method of determining the velocities of bullets will answer in practice.

In the 94th experiment, the recoil, with 165 grains of powder without a bullet, was 5.5 inches, and in the 95th experiment, with the same charge, the recoil was 5.6 inches. The mean is 5.55 inches, and the length of the rods by which the barrel was suspended being 64 inches, the velocity of the recoil ($= U$), answering to 5.55 inches measured upon the ribbon, is that of 1.1358 feet in a second.

In five experiments with the same charge of powder, and a bullet weighing 580 grains, the recoil was as follows, *viz.* : —

The 20th experiment	14.73 inches.
21st	“ 14.2
22d	“ 14.8
23d	“ 14.58
24th	“ 14.68
	5)73. (= 14.6 inches at a mean.

And the velocity of the recoil ($= V$) answering to this length (14.6 inches) is that of 2.9880 feet in a second; consequently $V - U$, or $2.9880 - 1.1358$ is equal to 1.8522 feet in a second.

But as the velocities of the recoil are known to be as the chords of the arcs through which the barrel ascends, it is not necessary, in order to determine the velocity of the bullet, to compute the velocities V and U ; but the quantity $\overline{V - U}$, or the difference of the velocities of the recoil when the given charge is fired with and without a bullet, may be computed from the value of the difference of the chords by one operation. Thus the velocity answering to the chord $9.05 = 14.6 - 5.55$ is that of 1.8522 feet in a second, which is just equal to $\overline{V - U}$, as was before found.

The weight of the barrel, together with its carriage, was $47\frac{1}{4}$ pounds, to which three quarters of a pound is to be added on account of the weight of the rods by which it was suspended, which makes $W = 48$ pounds, or 336,000 grains; and the weight of the bullet was 580 grains. B is, therefore, to W as 580 is to 336,000, that is, as 1 is 579.31 very nearly; and v ($= \frac{V-U}{B} \times W$) is equal to $V-U + 579.31$.

The value of $V-U$ answering to the experiments before mentioned was found to be 1.8522, consequently the velocity of the bullets ($= v$) was $1.8522 \times 579.31 = 1073$ feet in a second, which is extremely near 1083 feet in a second, the mean of the velocities, as they were determined by the pendulum.

But the computation for determining the velocity of a bullet upon these principles may be rendered still more simple and easy in practice; for the velocities of the recoil being as the chords measured upon the ribbon, if

c be put equal to the end of the chord of the recoil, expressed in English inches, when the piece is fired with powder only,

and $C =$ the chord when a bullet is discharged by the same charge,

then $C - c$ will be as $V - U$, and consequently as $\frac{V-U}{B} \times W$, which measures the velocity of the bullet; the ratio of W to B remaining the same.

If, therefore, we suppose a case in which $C - c$ is equal to one inch, and the velocity of the bullet be computed from that chord, the velocity in any other case in which $C - c$ is greater or less than one inch, will be found by multiplying the difference of the chords C

and c by the velocity that answers to a difference of one inch.

The length of the parallel rods by which the barrel was suspended being 64 inches, the velocity of the recoil answering to $C - c = 1$ inch, measured upon the ribbon, is 0.204655 parts of a foot in a second; and this is also, in this case, the value of $V - U$; the velocity of the bullet is therefore $v = 0.204655 \times 579.31 = 118.35$ feet in a second.

Consequently the velocity of the bullet, expressed in feet *per* second, may, in all cases, be found by multiplying the difference of the chords C and c by 118.35, the weight of the barrel, the length of the rods by which it is suspended, and the weight of the bullet remaining the same; and this, whatever the charge of powder may be that is made use of, and however it may differ in strength or goodness.

According to this rule, the velocities of the bullets in the following experiments have been computed from the recoil; and by comparing them with the velocities shewn by the pendulum, we shall be enabled to judge of the accuracy of this new method of determining the velocities of bullets.

In the 76th and 77th experiments, when the piece was fired with 145 grains of powder and a bullet, the recoil was 13.25 and 13.15, or 13.2 at a mean; and with the same charge of powder, without a bullet, the recoil was 4.5 and 4.3, or 4.4 at a mean (see the 84th and 93d experiments).

$C - c$ is therefore $13.2 - 4.4 = 8.8$ inches, and the velocity of the bullets $= 8.8 \times 118.35 = 1045$ feet in a second. The mean of the velocities as they were determined by the pendulum is that of 1040 feet in a

second. In the 104th and 105th experiments, the recoil was 12.92 and 13.28, and the velocity computed from the mean of those chords is 1030 feet in a second; but the velocity shewn by the pendulum was no more than about 900 feet in a second. As the recoil was so nearly equal to what it was in the 76th and 77th experiments before mentioned, when the velocities shewn by the recoil and by the pendulum were almost exactly the same, I am inclined to believe that there must have been some mistake in determining the velocities by the pendulum in these last experiments, and that the velocity shewn by the recoil is most to be depended on.

With 290 grains, or half the weight of the bullet in powder, in the 48th, 49th, and 50th experiments, the recoil was 22.58, 22.92, and 22.38; and the recoil with the same charge of powder, without a bullet, at a mean of the 60th and 96th experiments, was 10.66. The mean of the velocities of the bullets computed from the recoil is therefore 1416 feet in a second, and the velocity shewn by the pendulum was 1427 feet in a second; the difference is not considerable. The mean of the velocities in the 109th, 110th, 111th, 112th experiments is by the recoil 1464, and by the pendulum 1444 feet in a second.

With 330 grains of powder the velocities of the bullets appear to have been as follows, *viz.* : —

	Vent at 0.	Vent at 1.3.	Vent at 2.6.
By the Recoil,	1543	1620	1610
By the Pendulum,	1594	1625	1528

See the 62d, 63d, 64th, 65th, 66th, 67th, and 17th experiments.

The *uniformity of the recoil* was in all cases very remarkable. Thus, in the first set of experiments with

290 grains of powder (from the 48th to the 57th experiment inclusive), the recoil was,

Vent at 0.	Vent at 1.3	Vent at 2.6.
22.58	23.21	23.06
22.92	23.76	23.26
22.38	23.06	23.26
		23.56
3)67.88	3)70.03	4)93.14
Means = 22.626	23.343	and 23.285

If now we take a mean of the 60th and 96th experiments, and call the recoil, without a bullet, 10.66, as before, the velocities will turn out,

	Vent at 0.	Vent at 1.3.	Vent at 2.6.
By the recoil,	1416	1501	1494
And by the pendulum they were	1427	1493	1460
The difference is only	- 11	+ 8	+ 34

The recoil was equally regular in the 117th and five succeeding experiments, when the charge was no less than $437\frac{1}{2}$ grs. = 1 ounce avoirdupois in powder; and the velocities of the bullets determined from the recoil are very nearly the same as they were shewn by the pendulum. Thus, in the 117th, 118th, and 119th experiments the mean recoil was 33.3: and in the 120th, 121st, and 122d experiments it was 32.866. And if the recoil without a bullet be called 17.9, as it was determined by the 123d experiment, which was made immediately after the experiments before mentioned, then will the velocities be,

	Vent at 0.	Vent at 2.6.
By the recoil,	1822	1771
And by the pendulum they were	1764	1751
The difference is only	+ 58	+ 20 feet

in a second, which is less than what frequently occurs in repeating the same experiment.

In the 11th, 12th, 13th, and 14th experiments, when the piece was fired with 310 grains of powder and a bullet, the recoil was 24.69, 24.95, 24.9, and 24.9: and in the 15th, 16th, 18th, and 19th experiments, with 330 grains of powder, the recoil was 26.2, 26.2, 26.3, and 26.4. The regularity of these numbers is very striking; and though we cannot compare the velocities of the bullets determined by the two methods, as we have done in other cases (as there are reasons to believe that the velocities, as they are set down in the tables, are not much to be depended on, and as the recoil, with the given charge of 310 grains of powder, without a bullet, is not known), yet the regularity of the recoil in these experiments affords good grounds to conclude that the method of determining the velocities of bullets founded upon it must be very accurate.

But of all the experiments those numbered from 84 to 92, inclusive, afford the strongest proof of the accuracy of this method. In those, every possible precaution was taken to prevent errors arising from adventitious circumstances; and the weights of the bullets and their velocities were so various that the uniform agreement of the two methods of determining the velocities, in those trials, amounts almost to a demonstration of the truth of the principles upon which this new method is founded.

By the following table the result of these experiments may be seen at one view.

The Experiments.	Weight of the Bullets. Grs.	The Barrel heavier than the Bullet. $\frac{W}{B} =$	The Recoil. C =	Velocity of the Bullet.		Difference.
				By the Recoil. $v =$	By the Pendulum. $v =$	
84th and 93d	—	—	($c = 4.4$)	—	—	—
85th	90	3733.3	7.16	2109	1763	+346
86th	251	1338.6	9.62	1430	1317	+113
87th	354	949.15	11.03	1288	1136	+152
88th	600	560.	15.22	1240	1229	+ 11
89th	603	557.22	15.13	1224	1229	— 5
90th	1184	283.78	21.92	1017	978	+ 39
91st	1754	191.56	27.18	893	916	— 23
92d	2352	141.86	32.25	812	833	— 21

The charge of powder consisted of 145 grains in weight in each experiment.

In order to shew in a more striking manner the result of these experiments and the comparison of the two methods of ascertaining the velocities of bullets, I have drawn the Fig. 16 where the numbers that are marked upon the line AB are taken from A towards B, in proportion to the weights of the bullets; while the lines drawn from those numbers, perpendicular from AB (as w, v , for instance at the number 2352) and ending at the curve c, d , express their velocities as shown by the pendulum. The continuations of those lines on the opposite side of the line AB shew the recoil, and also the velocities of the bullets as determined from it: thus w, r , and the (dotted) lines parallel to it, which end at the line g, f , express the recoil; and the portion of each of those lines that is comprehended between the line AB and the curve m, n , (as w, u ,) is as the velocity of the bullet in the several experiments. The line A, e , denotes the weight of the charge of powder; and the line A, m , the velocity with which the elastic fluid escapes out of the piece, when the powder is fired without any bullet.

Upon an inspection of this figure, as well as from an examination of the foregoing table, it appears that the velocities determined by the two methods agree with great nicety in all the experiments after the 87th; but in the 87th experiment and also in the 86th, but particularly in the 85th, the difference in the result of these different methods is very considerable: and it is remarkable that in those experiments, where they disagree most, the velocities of the bullets, as determined by the pendulum, are extremely irregular; while, on the other hand, the gradual increase of the recoil as the bullets were heavier, and the great regularity of the corresponding velocities, afford good grounds to conclude that this disagreement is not owing to any inaccuracy in the new method of ascertaining the velocities, but to some other cause, which remains to be investigated.

But before we proceed in this inquiry, let us separate the five last experiments in the foregoing table; and summing up the velocities determined by the two methods, we shall see by their difference how those methods agreed, upon the whole, in this instance.

Experiments.	Weight of the Bullets. Grs.	Velocity.		Difference.
		By the Recoil.	By the Pendulum.	
88th	600	1240	1229	+ 11
89th	603	1224	1229	— 5
90th	1184	1017	978	+ 39
91st	1754	893	916	— 23
92d	2352	812	833	— 21
Sums & diff. of the Velocities,		5186	5185	+ 1

Here the difference in the result of the two methods does not amount to $\frac{1}{5000}$ th part of the whole velocity; but I lay no stress upon this extraordinary argument. I am sensible that it must in some degree have been

accidental; but as the difference in the velocities, computed by these different methods, was in no instance considerable, not being in any case so great as what frequently occurred in the most careful repetition of the same experiment, and as the velocities, as determined by the recoil, were much more regular than those shewn by the pendulum, as appears by comparing the curves, *g, f,* and *m, n,* (Fig. 16) with the crooked line *c, d,* I think we may fairly conclude that this new method may with safety be relied on in practice.

The greatest difference in the velocities, as ascertained by the two methods, appears in the instance of the 85th experiment, where the velocity, determined from the recoil, exceeds that shewn by the pendulum, by 346 feet in a second, the former velocity being that of 2109 feet in a second, the latter only 1763 feet in a second; and in the two succeeding experiments, the velocities shewn by the pendulum are likewise deficient, though not in so great a degree.

This apparent deficiency remains now to be accounted for; and first, it cannot be supposed that it arose from any imperfection in Mr. Robins's method of determining the velocities of bullets, for that method is founded upon such principles as leave no room to doubt of its accuracy; and the practical errors that occur in making the experiments, and which cannot be entirely prevented, or exactly compensated, are in general so small that the difference of the velocities in question cannot be attributed to them. It is true the effect of those errors is more likely to appear in experiments made under such circumstances as those under which the experiments we are now speaking of were made, than in any other case; for the bullets being very light, the arc of the ascent of

the pendulum was but small, and a small mistake in measuring the chord upon the ribbon would have produced a very considerable error in computing the velocity of the bullet; thus, a difference of one tenth of an inch, more or less, upon the ribbon in the 85th experiment would have made a difference in the velocity of more than 120 feet in a second. But independent of the pains that were taken to prevent mistakes, the striking agreement of the velocities determined by the two methods in the experiments which immediately follow, as also in all other cases where they could be compared, affords abundant reason to conclude that the errors arising from those causes were in no instance very considerable.

But if both methods of ascertaining the velocities of bullets are to be relied on, then the difference of the velocities, as determined by them, in these experiments, can only be accounted for by supposing that it arose from their having been diminished by the resistance of the air in the passage of the bullets from the mouth of the piece to the pendulum; and this suspicion will be much strengthened when we consider how great the resistance is that the air opposes to bodies that move very swiftly in it, and that the bullets in these experiments were not only projected with great velocities, but were also very light, and consequently more liable to be retarded by the resistance on that account.

To put the matter beyond all doubt, let us see what the resistance was that these bullets met with, and how much their velocities were diminished by it. The weight of the bullet (in the 85th experiment) was 90 grains; its diameter was 0.78 of an inch, and it was projected with a velocity of 2109 feet in a second.

If now a computation be made according to the method laid down by Sir Isaac Newton for compressed fluids, it will be found that the resistance to this bullet was not less than $8\frac{1}{2}$ lbs. avoirdupois, which is something more than 660 times its weight. But Mr. Robins has shewn, by experiment, that the resistance of the air to bodies moving in it with very great velocity is near three times greater than Sir Isaac has determined it, and as the velocity with which this bullet was impelled is considerably greater than any in Mr. Robins's experiments, it is highly probable that the resistance in this instance was at least 2000 times greater than the weight of the bullet.

The distance from the mouth of the piece to the pendulum, as we have before observed, was 12 feet; but, as there is reason to think that the blast of the powder, which always follows the bullet, continues to act upon it for some sensible portion of time after it is out of the bore, and by urging it on counterbalances, or at least counteracts, in a great measure the resistance of the air, we will suppose that the resistance does not begin, or rather that the motion of the bullet does not begin to be retarded, till it has got to the distance of two feet from the muzzle. The distance, therefore, between the barrel and the pendulum, instead of 12 feet, is to be estimated at 10 feet; and as the bullet took up about $\frac{1}{192}$ part of a second in running over that space, it must, in that time, have lost a velocity of about 335 feet in a second, as will appear upon making the computation, and this will very exactly account for the apparent diminution of the velocity in the experiment; for the difference of the velocities, as determined by the recoil and by the pendulum, = $2109 - 1763 = 346$ feet

in a second, is extremely near 335 feet in a second, — the diminution of the velocity by the resistance as here determined.

If the diminution of the velocities of the bullets in the two subsequent experiments be computed in like manner, it will turn out in the 86th experiment = 65 feet in a second, and in the 87th experiment = 33 feet in a second; and making these corrections, the comparison of the two methods of ascertaining the velocities will stand thus: —

	85th Exp.	86th Exp.	87th Exp.
Velocities shown by the pendulum,	1763	1317	1136
Add the diminution of the velocity } by the resistance of the air, }	335	65	33
Making together	2098	1382	1169
Velocity by the recoil,	2109	1430	1288
The difference =	+11	+48	+119

So that it appears, notwithstanding these corrections, that the velocities in the 86th and 87th experiments, and particularly in the last, as they were determined by the pendulum, are still considerably deficient. But the manifest irregularity of the velocities in those instances affords abundant reason to conclude that it must have arisen from some extraordinary accidental cause, and, therefore, that little dependence is to be put upon the result of those experiments. I cannot take upon me to determine positively what the cause was which produced this irregularity; but I strongly suspect that it arose from the breaking of the bullets in the barrel by the force of the explosion; for these bullets, as has already been mentioned, were formed of lead, inclosing lesser bullets of plaster of Paris; and I well remember to have observed at the time several small fragments of the plaster, which had fallen down by the side of the

pendulum. I confess I did not then pay much attention to this circumstance, as I naturally concluded that it arose from the breaking of the bullet in penetrating the target of the pendulum, and that the small pieces of plaster I saw upon the ground had fallen out of the hole by which the bullet entered. But if the bullets were not absolutely broken in pieces in the firing, yet if they were considerably bruised, and the plaster, or a part of it, were separated from the lead, such a change in their form might produce a great increase of the resistance, and even their initial velocities might be affected by it; for their form being changed from that of a globe to some other figure, they might not fit the bore, and a part of the force of the charge might be lost by the windage.

That this actually happened in the 87th experiment seems very probable, as the velocity with which the bullet was projected, even as it was determined by the recoil, is considerably less, in proportion, in that experiment, than in either of those that precede it in that set, or in those which follow it, as will appear upon inspecting the curvature of the line *m, n*, Fig. 16. But I forbear to insist further upon this matter.

As I have made an allowance for the resistance of the air in these experiments, it may be expected that I should do it in all other cases; but I think it will appear, upon inquiry, that the diminution of the velocities of the bullets on that account was, in general, so inconsiderable that it might safely be neglected; thus, for instance, in the experiments with an ounce of powder, when the velocity of the bullet was more than 1750 feet in a second, the diminution turns out no more than about 25 or 30 feet in a second, though we sup-

pose the full resistance to have begun so near as two feet from the mouth of the piece; and in all cases where the velocities were less, the effect of the resistance was less in a much greater proportion; and even in this instance there is reason to think that the diminution of the velocity, as we have determined it, is too great; for the flame of gunpowder expands with such an amazing rapidity that it is scarcely to be supposed but that it follows the bullet and continues to act upon it more than two feet, or even four feet, from the gun, and when the velocity of the bullet is less, its action upon it must be sensible at a still greater distance.

With 218 grains of powder, the recoil appears to have been very uniform; but if the velocities of the bullets are determined from the recoil in the 40th and seven following experiments, when this charge was made use of, and from the recoil without a bullet in the 72d and 73d experiments, the velocities will turn out considerably too small, as we shall see by making the computation.

		Vent at 0.			Vent at 1.3.
The recoil in the	{	40th exp. was	18.	and in the	43d exp. it was
		41st	17.71	44th	18.35
		42d	17.91	45th	18.35
		47th	18.1	46th	18.35
		4)71.72			4)73.35
Means =		17.93	and		18.34

And in the 72d and 73d experiments the recoil, with the same charge without a bullet, was 8.72 and 8.47 = 8.595 at a medium; the velocities therefore turn out,

	Vent at 0.	Vent at 1.3.
By the recoil	1105	1153
instead of	1225	1276

and as they were shown by the pend.

The diff. 120 and 123 feet in a second amounts to near one twelfth part of the whole velocity.

This difference is undoubtedly owing to the recoil without a bullet being taken too great, for it is not only greater than it ought to be, in order that the velocities of the bullets may come out right, but it is considerably greater in proportion than the recoil with any other charge.

Thus, with 145 grains of powder	the recoil was	4.4
with 165 grains	it was	5.55
290 grains		10.66
330 grains		12.7
and with 437½ grains	it was	17.9

And if the recoil with 218 grains is determined from these numbers by interpolation, it comes out 7.5; and with that value for C, the velocities of the bullets in the before-mentioned experiments appear to be,

	Vent at 0.	and	Vent at 1.3.	by the recoil
	1243		1283	
which is extremely near	1225	and	1276	the velocities
shown by the pendulum.				

It is to be remembered, that the 72d and 73d experiments, from which we before determined the recoil with the given charge of powder without a bullet, were not made upon the same day with the experiments before mentioned; and it is well known that the force of powder is different upon different days. And it is worthy of remark, that in those two experiments the strength of government powder appeared to be considerably the greatest. I mention these circumstances to shew the probability there is that the recoil in those experiments, from some unknown cause, was greater than it ought to have been, or rather than it would have been had the experiments been made at the same time when the experiments with the bullets were made, or at any other time under the same circumstances.

As this method of determining the velocities of the bullets did not occur to me till after I had finished the course of my experiments, and had taken down my apparatus, I have not had an opportunity of ascertaining the recoil with and without a bullet with that degree of precision that I could wish. If I had thought of it sooner, or if I had recollected that passage in Mr. Robins's new Principles of Gunnery where he says, "The part of the recoil arising from the expansion of the powder alone is found to be no greater when it impels a leaden bullet before it than when the same quantity is fired without any wad to confine it,"—I say, if that passage had occurred to me before it had been too late, I certainly should have taken some pains to have ascertained the fact; but as it is, I think enough has been done to shew that there is the greatest probability that the velocities of bullets may, in all cases, be determined by the recoil with great accuracy; and I hope soon to have it in my power to put the matter out of all doubt, and to verify this new method by a course of conclusive experiments, which I am preparing for that purpose.

In the mean time I would just observe, that if this method should be found to answer when applied to musket bullets, it cannot fail to answer equally well when it is applied to cannon balls and bomb shells of the largest dimensions; and it is apprehended that it will be much preferable to any method hitherto made public; not only as it may be applied indifferently to all kinds of military projectiles, and that with very little trouble and expence in making the experiment; but also, because by it the velocities with which bullets are *actually projected* are determined; whereas by the pendulum

their velocities can only be ascertained at some distance from the gun, and after they have lost a part of their initial velocities by the resistance of the air through which they are obliged to pass to arrive at the pendulum.

At the trifling expence of ten or fifteen pounds, an apparatus might be constructed that would answer for making the experiments with all the different kinds of ordnance in the British service. The advantages that might be derived from such a set of experiments are too obvious to require being mentioned.

Of a very accurate Method of proving Gunpowder.

All the *éprouvettes*, or powder-triers, in common use are defective in many respects. Neither the absolute force of gunpowder can be determined by means of them, nor the comparative force of different kinds of it, but under circumstances very different from those in which the powder is made use of in service.

As the force of powder arises from the action of an elastic fluid that is generated from it in its inflammation, the quicker the charge takes fire, the more of this fluid will be generated in any given short space of time, and the greater of course will be its effect upon the bullet. But in the common method of proving gunpowder, the weight by which the powder is confined is so great in proportion to the quantity of the charge, that there is time quite sufficient for the charge to be all inflamed, even when the powder is of the slowest composition, before the body to be put in motion can be sensibly removed from its place. The experiment, therefore, may shew which of two kinds of powder is the strongest when equal quantities of both are confined in

equal spaces, and *completely inflamed*; but the degree of inflammability, which is a property essential to the goodness of the powder, cannot by these means be ascertained.

Hence it appears how powder may answer to the proof, such as is commonly required, and may nevertheless turn out very indifferent when it comes to be used in service. And this, I believe, frequently happens; at least I know that complaints from officers of the badness of our powder are very common; and I would suppose that no powder is ever received by the Board of Ordnance but such as has gone through the established examination, and has answered to the usual test of its being of the standard degree of strength.

But though the common powder-tryers may shew powder to be better than it really is, they never can make it appear to be worse than it is. It will therefore always be the interest of those who manufacture that commodity to adhere to the old method of proving it; but the purchaser will find his account in having it examined in a manner by which its goodness may be ascertained with greater precision.

The method I would recommend is as follows. A quantity of powder being provided, which from any previous examination or trial is known to be of a proper degree of strength to serve as a standard for the proof of other powder, a given charge of it is to be fired, with a fit bullet, in a barrel suspended by two pendulous rods, according to the method before described, and the recoil is to be carefully measured upon the ribbon; and this experiment being repeated three or four times, or oftener, if there should be any considerable difference in the recoil, the mean and the extremes of the chords may be

marked upon the ribbon, by black lines drawn across it, and the word *proof* may be written upon the middle line; or if the recoil be uniform (which it will be, to a sufficient degree of accuracy, if care is taken to make the experiments under the same circumstances), then the *proof mark* is to be made in that part of the ribbon to which it was constantly drawn out by the recoil in the different trials.

The recoil with a known charge of standard powder being thus ascertained, and marked upon the ribbon, let an equal quantity of any other powder (that is to be proved) be fired in the same barrel, with a bullet of the same weight, and every other circumstance alike, and if the ribbon is drawn out as far or farther than the proof mark, the powder is as good or better than the standard; but if it falls short of that distance, it is worse than the standard, and is to be rejected.

For the greater the velocity is with which the bullet is impelled, the greater will be the recoil; and when the recoil is the same, the velocities of the bullets are equal, and the powder is of the same degree of strength if the quantity of the charge is the same. And if care is taken in proportioning the charge to the weight of the bullet, to come as near as possible to the medium proportion that obtains in practice, the determination of the goodness of gunpowder from the result of this experiment cannot fail to hold good in actual service.

Fig. 14 represents the proposed apparatus drawn to a scale of one foot to the inch. *a, b*, is the barrel suspended by the pendulous rods *c, d*; and *r* is the ribbon for measuring the recoil.

The length of the bore is 30 inches, and its diameter is one inch, consequently it is just 30 calibres in length, and will carry a leaden bullet of about 3 ounces.

The barrel may be made of gun-metal, or of cast-iron, as that is a cheaper commodity; but great care must be taken, in boring it, to make the cylinder perfectly straight and smooth, as well as to preserve the proper dimensions. Of whatever metal the barrel is made, it ought to weigh at least 50 lbs., in order that the velocity of the recoil may not be too great; and the rods by which it is suspended should be five feet in length. The vent may be about one twentieth of an inch in diameter; and it should be *bouched* or lined with gold, in the same manner as the touchhole is made in the better kind of fowling-pieces, in order that its dimensions may not be increased by repeated firing.

The bullets should be made to fit the bore with very little windage; and it would be better if they were all cast in the same mould and of the same parcel of lead, as in that case their weights and dimensions would be more accurately the same, and the experiments would of course be more conclusive.

The stated charge of powder may be half an ounce, and it should always be put up in a cartridge of very fine paper; and after the piece is loaded it should be primed with other powder, first taking care to prick the cartridge by thrusting a priming-wire down the vent.

As it appears, from several experiments made on purpose to ascertain the fact, that ramming the powder more or less has a very sensible effect to increase or diminish the force of the charge, to prevent any inaccuracies that might arise from that cause, a ramrod such as is represented Fig. 15 may be made use of. It is to be made of a cylindrical piece of wood in the same manner as ramrods in general are made, but with the addition of a ring, C, about one inch and a half or two inches in

diameter, which, being placed at a proper distance from the end (*a*) of the ramrod that goes up into the bore, will prevent its being thrust up too far. This ring may be made of wood or of any kind of metal, as shall be found most convenient. The other end of the ramrod (*b*) may be 31 or 32 inches in length from the ring, and the extremity of it being covered with a proper substance, it may be made use of for wiping out the barrel after each experiment.

The machine (*f*) for the tape to slide through may be the same as that described by Dr. Hutton in his account of his experiments on the initial velocities of cannon balls, as his method is much better calculated to answer the purpose than that proposed and made use of by Mr. Robins. It will also be better for the axis of each of the pendulous rods to rest upon level pieces of wood or iron, than for them to move in circular grooves; care must however be taken to confine them by staples, or by some other contrivance, to prevent their slipping out of their places.

The trunnions, by means of which the barrel is connected with the pendulous rods and upon which it is supported, should be as small as possible, in order to lessen the friction; and for the same reason they should be well polished, as well as the grooves which receive them. They need not be cast upon the barrel, but may be screwed into it after it is finished.

In making the experiments, regard must be had to the heat of the barrel as well as to the temperature and state of the atmosphere; for heat and cold, dryness and moisture, have very sensible effects upon gunpowder, to increase or diminish its force. If therefore a very great degree of accuracy is at any time required, it will

be best to begin by firing the piece two or three times, merely to warm it; after which three or four experiments may be made with standard powder, to determine anew the proof mark (for the strength of the same powder is different upon different days); and when this is done, the experiments with the powder that is to be proved are to be made, taking care to preserve the same interval of time between the firings, that the heat of the piece may be the same in each trial.

If all these precautions are taken, and if the bullets are of the same weight and dimensions, powder may be proved by this method with much greater accuracy than has hitherto been done by any of the methods hitherto used for that purpose.

Of the comparative Goodness, or Value, of Powder' of different Degrees of Strength.

Let V denote the velocity of the bullet with the stronger powder, and put v equal to the velocity with the weaker, when the charges are equal, and the weight and dimensions of the bullets are the same, and when they are discharged from the same piece. If the charge is augmented when the weaker powder is made use of, till the velocity of the bullet is increased from v to V , or till it becomes equal to the velocity with the given charge of the stronger powder, the *value* of the charges may then be said to be equal; and consequently the weaker powder is as much worse than the stronger — or is of less value — in proportion as the quantity of it, by the pound, required to produce the given effect is greater.

But we have seen that the velocities, with different quantities of the same kind of powder, are in the *subduplicate ratio* of the weights of the charges. The

charges, therefore, must be as the squares of the velocities, and consequently the charge of the weaker powder must be to that of the stronger, when the velocities are equal, as VV is to vv . The weaker powder is therefore as much worse than the stronger as VV is greater than vv ; or the comparative goodness of powder of different degrees of strength is as the squares of the velocities of the bullets, when the charges are equal.

The mean velocity of the bullets, as shewn by the pendulum, in the 104th and 105th experiments, when the piece was fired with 145 grains of government powder, was 894 feet in a second; and with the same quantity of *double proof** battle powder (experiment No. 106), the velocity was 990 feet in a second. Now the squares of these velocities (which, as we just observed, measure the goodness of the powder) are to each other as 1 is to 1.2263, or nearly as 5 is to 6.

With 218 grains of government powder, the mean velocity in four experiments (*viz.* the 40th, 41st, 42d, and 43d) was 1225 feet in a second; and in the experiment No. 107, when the same quantity of *double proof* battle powder was made use of, the velocity was 1380 feet in a second; and 1225^2 is to 1380^2 as 1 is to 1.2691.

With 290 grains, or half the weight of the bullet in government powder in the 109th, 110th, 111th, and 112th experiments, the mean velocity of the bullet was 1444 feet in a second; but with the same quantity of the battle powder (experiment No. 116), the velocity was 1525 feet in a second; 1444^2 is to 1525^2 as 1 is to 1.1153.

By taking a medium of these trials it appears that double proof battle powder is better than government

* This is called *battle* powder, not because it is used in battle or in war, but from *Battle*, the name of a village in Kent, where that kind of powder is made.

powder, in proportion as 1.2036 is to 1, or nearly as 6 is to 5.

But if, instead of weighing the powder, we estimate the quantity of the charge by measurement, or the space it occupies in the bore of the piece, the comparative strength of battle powder will appear to be considerably greater, or its strength will be to that of government powder nearly as 4 is to 3; for the grains of this better kind of powder being more compact, and nearly of a spherical form, a greater weight of it will lie in any given space than of government powder, which is formed more loosely, and of various and of very irregular figures.

Now the common price of double proof battle powder, as it is sold by the wholesale dealers in that commodity, is at the rate of £10 *per* cwt. net, which is just two shillings by the pound; while government is sold at £5 5s. *per* hundred, or one shilling and $\frac{6}{10}$ th of a penny *per* pound; but battle powder is better than government powder only in the proportion of 1.2036 to 1, or of one shilling and two pence to one shilling and $\frac{6}{10}$ th of a penny; battle powder is therefore sold at the rate of ten pence by the pound, or $41\frac{2}{3}$ *per cent.* dearer than it ought to be; or those who make use of it in preference to government powder do it at a certain loss of $41\frac{2}{3}$ *per cent.* of the money that the powder costs them.

Of the Relation of the Velocities of Bullets to their Weights.

According to Mr. Robins's theory, when bullets of the same diameter but different weights are discharged from the same piece, by the same quantity of powder, their *velocities* should be in the *reciprocal sub-duplicate ratio of their weights*; but as this theory is founded upon

a supposition that the action of the elastic fluid generated from the powder, is always the same in any and every given part of the bore, when the charge is the same, whatever may be the weight of the bullet, and as no allowance is made for the expenditure of force required to put the fluid itself in motion or for the loss of it by the vent, it is plain that the theory is defective. It is true, Dr. Hutton in his experiments found this law to obtain without any great error, and possibly it may hold good with sufficient accuracy in many cases; for it sometimes happens that a number of errors, or actions, whose operations have contrary tendencies, so compensate each other that their effects, when united, are not sensible. But when this is the case, if any one of the causes of error be removed, those which remain will be detected.

When any given charge is loaded with a heavy bullet, more of the powder is inflamed in any very short space of time than when the bullet is lighter, and the action of the powder ought, of course, to be greater on that account; but then, a heavy bullet takes up more time in passing through the bore than a light one, and consequently more of the elastic fluid generated from the powder escapes by the vent and by windage. It may happen that the augmentation of the force on account of one of these circumstances may exactly counterbalance the diminution of it arising from the other; and if it should be found upon trial that this is the case in general, in pieces as they are now constructed, and with all the variety of shot that are made use of in practice, it would be of great use to know the fact: and possibly it might answer as well, as far as it relates to the art of gunnery, as if we were perfectly acquainted with, and were

able to appreciate, the effect of each varying circumstance, under which an experiment can be made. But when, concluding too hastily from the result of a partial experiment, we suppose, with Mr. Robins, that, because the sum total of the action or pressure of the elastic fluid upon the bullet, during the time of its passage through the bore, happens to be the same when bullets of different weights are made use of (which collective pressure is in all cases proportional to, and is accurately measured by, the velocity, or rather motion, communicated to the bullet), that, *therefore*, the pressure in any given part is always exactly the same when the quantity of powder is the same with which the piece is fired; and from thence endeavour to prove that the inflammation of gunpowder is instantaneous, or that the whole charge is, in all cases, inflamed and “converted into an elastic fluid before the bullet is sensibly moved from its place,” — such reasonings and conclusions may lead to very dangerous errors.

It is undoubtedly true, that if the principles assumed by Mr. Robins, with respect to the manner in which gunpowder takes fire, and the relation of the elasticity of the generated fluid to its density, or the intensity of its pressure upon the bullet, as it expands in the barrel, were just, and if the loss of force by the vent and by windage were in all cases inconsiderable, or if it were prevented, the deductions from the theory respecting the velocities of bullets of different weights would always hold good. But if, on the contrary, it should be found upon making the experiments carefully, and in such a manner as entirely to prevent inaccuracies arising from adventitious circumstances, that the velocities observe a law different from that which the theory supposes, we

may fairly conclude that the principles upon which the theory is founded are erroneous.

Let us now see how far these experiments differ from the theory. Those numbered from 84 to 92 inclusive were made in such a manner that no part of the force of the powder was lost by the vent or by windage, as has already been mentioned, and all possible attention was paid to every circumstance that could contribute to render them perfect and conclusive.

A particular account has already been given of them, and notice has been taken of the means that were used for forming the bullets and making them fit the bore, and of the contrivance for preventing the escape of the elastic fluid by the vent. The following table shews the results of them.

N. B. The charge of powder was the same in each experiment, and consisted of 145 grains in weight.

Experiment.	Weight of the Bullet. Grs.	Velocity of the Bullet.		Difference.
		Actual.	Computed.	
85	90	2109	2109	—
86	251	1430	1262	+168
87	354	1288	1063	+225
88	600	1240	817	+423
89	603	1224	815	+409
90	1184	1017	581	+436
91	1754	893	478	+415
92	2352	812	413	+399

The computed velocities, as they are set down in this table, were determined from the actual velocity of the bullet, as determined by the recoil, in the 85th experiment, and the reciprocal sub-duplicate ratio of its weight to the weight of the bullet in each subsequent experiment; and in the last column is marked the difference

between the experiment and the theory, or the number of feet in a second by which the actual velocity exceeded the computed.

But in order that we may see this matter in different points of view, let the order of the experiments be now inverted, and let the computed velocities be determined from the actual velocity in the 92d experiment; and assuming the total or collective pressure exerted by the power upon the bullet in that experiment equal to unity, let the collective pressure in the other experiments be computed from the ratio of the actual to the computed velocities, and the table will stand thus:—

Experiment.	Weight of the Bullet. Grs.	Velocity of the Bullet.		Difference.	Collective Pressure.
		Actual.	Computed.		
92	2352	812	812	—	1.0000
91	1754	893	940	— 47	0.9020
90	1184	1017	1145	— 128	0.7897
89	603	1224	1604	— 380	0.5825
88	600	1240	1608	— 368	0.5949
87	354	1288	2093	— 805	0.3778
86	251	1430	2486	—1056	0.3310
85	90	2109	4151	—2042	0.2581

In the following figure let A B represent the axis of the piece, and A P the length of the space filled with powder; and at the point P let the perpendicular P H be erected, upon which let P L and P M be taken from P towards H of such magnitudes that while P L expounds the uniform force of gravity, or the weight of the bullet, P M shall be as the force exerted by the powder upon the bullet, at the moment of the explosion. If now we suppose that while the bullet moves on from P towards B, the line P M or *p m* goes along with it, and that the point *m* is always taken in such a manner that

the line pm shall be to pl or PL as the force acting upon the bullet in the point p is to its weight, till pm co-

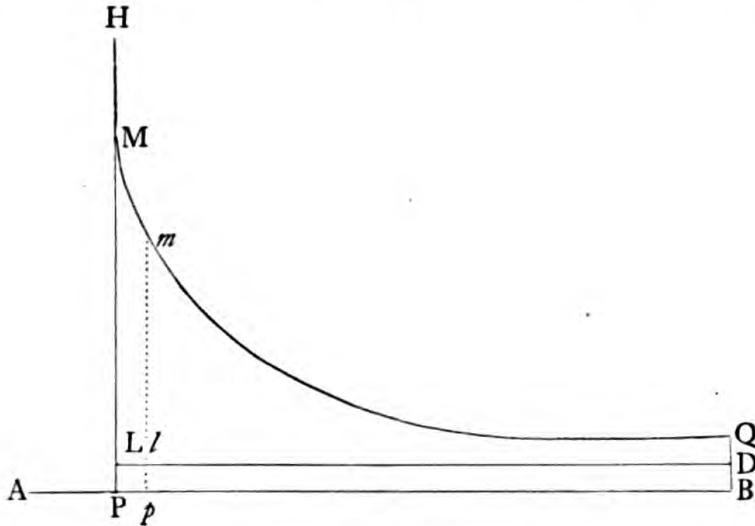

incides with QB , then will the area $PMQB$ be to the area $PLDB$ in the duplicate proportion of the velocities which the bullet would acquire when acted on by its own gravity through the space PB , and when impelled through the same space by the force of the powder, as may be seen demonstrated by Sir Isaac Newton in his *Mathematical Principles of Natural Philosophy*, Book I., prop. 39.

Now what I call the collective pressure, or sum total of the action of the powder upon the bullet, is the measure of the area $PMQB$; and it is plain, from what has been said above, that its measure may in all cases be accurately determined, when the weight and velocity of the bullet are known.

If all the powder of the charge were inflamed at once, or before the bullet sensibly moved from its place, and if the pressure of the generated fluid were always as its density, or inversely as the space it occupies, then would

the line M Q be an hyperbola, the area P M Q B would always be the same when the charge was the same, and consequently the velocities of the bullets would be as the square roots of their weights inversely. But it appears, from the before-mentioned experiments, that when the weight of the bullet was increased four times, the action of the powder, or area P M Q B, was nearly doubled; for in the 92d experiment, when four bullets were discharged at once, the collective pressure was as 1; but in the 89th experiment, when a single bullet was made use of, the collective pressure was only as 0.5825; and in the 85th, 86th, and 87th experiments, when the bullets were much lighter, the action of the charge on them was still less.

But though we can determine with great certainty, from these experiments, *the ratio in which the action of the powder upon the bullet was increased or diminished*, by making use of bullets of greater or less weight, yet we cannot from thence ascertain the relation of the elasticity of the generated fluid to its density, nor the quantity of powder that is inflamed at different periods before and after the bullet begins to move in the bore.

But assuming Mr. Robins's principles, as far as relates to the elasticity of the fluid, and supposing that in all the experiments except the 92d, a part only of the charge took fire, and that that part was inflamed and converted into an elastic fluid before the bullet began to move, upon that supposition we can determine the quantity of powder that took fire in each experiment, for the quantity of powder in that case would be as the collective pressure.

Thus if the whole charge, = 145 grains in weight, is supposed to have been inflamed in the 92d experiment,

the quantity inflamed in each of the other experiments will appear to have been as follows, viz. : —

Experiment.	Weight of the Bullet. Grs.	Velocity of the Bullet.	Collective Pressure.	Powder Inflamed. Grs.
85	90	2109	0.2581	37
86	251	1430	0.3310	48
87	354	1288	0.3778	55
88	600	1240	0.5949	86
89	603	1224	0.5825	84
90	1184	1017	0.7897	114
91	1754	893	0.9020	131

But there are many reasons to suppose that the diminution of the action of the powder upon the bullet when it is lighter is not so much owing to the smallness of the quantity of powder that takes fire in that case, as to the *vis inertiae* of the generated fluid. It is true that a greater portion of the charge takes fire and burns when the bullet is heavy than when it is light, as I found in the very experiments of which I am now speaking; but then, the quantity of unfired powder in any case was much too small to account for the apparent diminution of the force when light bullets were made use of.

If the elastic fluid, in the action of which the force of powder consists, were infinitely rare, or if its weight bore no proportion to that of the powder that generated it, and if the gross matter, or *caput mortuum* of the powder, remained in the bottom of the bore after the explosion, then, and upon no other supposition, would the pressure upon the bullet be inversely as the space occupied by the fluid; but it is evident that this can never be the case.

A curious subject for speculation here occurs: How

far would it be advantageous, were it possible, to diminish the specific gravity of gunpowder, and the fluid generated from it, without lessening its elastic force? It would certainly act upon very light bullets with greater force; but when heavy ones came to be made use of, there is reason to think that, except extraordinary precaution was taken to prevent it, the greatest part of the force would be lost by the vent and by windage.

The velocity with which elastic fluids rush into a void space is as the elasticity of the fluid directly, and inversely as its density; if, therefore, the density of the fluid generated from powder were four times less than it is, its elasticity remaining the same, it would issue out at the vent, and escape by the side of the bullet in the bore, with nearly four times as great a velocity as it does at present; but we know from experiment that the loss of force on those accounts is now very considerable.

In the experiments Nos. 76 and 77, when the piece was fired with 145 grains of powder, the velocity of the bullets at a medium was 1040 feet in a second; but in the 88th and 89th experiments, when the bullets were even heavier, and the piece was fired with the same quantity of powder, the mean velocity was 1232 feet in a second. The difference, = 192 feet in a second, answers to a difference of force, greater in the last experiments than in the first in the proportion of 14 to 10.

I know of no way to account for this difference but by supposing that it was owing entirely to the escape of the elastic fluid by the vent and by windage, in those experiments where the vent was open, and the bullets were put naked into the piece.

An elastic bow, made of very light wood, will throw an arrow, and especially a light one, with greater velocity

than a bow of steel of the same degree of stiffness; but for practice I think it is plain that gunpowder may *be supposed* to be so light as to be rendered entirely useless, and for some purposes it seems probable that it would not be the worse for being even heavier than it is now made. Vents are absolutely necessary in fire-arms, and in large pieces of ordnance the windage must be considerable, in order that the bullets, which are not always so round as they should be, may not stick in the bore; and those who have been present at the firing of heavy artillery and large mortars with shot and shells must have observed that there is a sensible space of time elapses between the lighting of the prime and the explosion; and that during that interval, the flame is continually issuing out at the vent with a hissing noise, and with a prodigious velocity, as appears by the height to which the stream of fire mounts up in the air. It is plain that this loss must be greater in proportion as the shot that is discharged is heavier; and I have often fancied that I perceived a sensible difference in the time that elapsed between the firing of the prime and the explosion when bullets were discharged, and when the piece has been fired with powder only; the time being apparently longer in the former case than the latter.

Almost all the writers upon gunpowder, and particularly those of the last century, gave different *recipes* for powder that is designed for different uses. Thus the French authors mention *poudre a mousquet*, *poudre ordinaire de guerre*, *poudre de chasse*, and *poudre d'artifice*; all of which are composed of nitre, sulphur, and charcoal, taken in different proportions. Is it not probable that this variety in the composition of powder was originally introduced, in consequence of observation that one kind

of powder was better adapted for particular purposes than another, or from experiments made on purpose to ascertain the fact? There is one circumstance that would lead us to suppose that that was the case. That kind of powder which was designed for great guns and mortars was weaker than those which were intended to be used in smaller pieces; for if there is any foundation for these conjectures, it is certain that the weakest powder, or the heaviest in proportion to its elastic force, ought to be used to impel the heaviest bullets, and particularly in guns that are imperfectly formed, where the vent is large and the windage very great.

I am perfectly aware that an objection may here be made, viz. that the elastic fluid which is generated from gunpowder must be supposed to have the same properties very nearly, whatever may be the proportion of the several ingredients, and that therefore the only difference there can be in powder is, that one kind may generate more of this fluid and another less; and that when it is generated, it acts in the same manner, and will alike escape, and with the same velocity, by any passage it can find. But to this I answer, though the fluid may be the same, as undoubtedly it is, and though its density and elasticity may be the same in all cases, at the instant of its generation, yet, in the explosion, the elastic and unelastic parts are so mixed and blended, that I imagine the fluid cannot expand without taking the gross matter along with it, and the velocity with which the flame issues out at the vent is to be computed from the elasticity of the fluid and the density or weight of the fluid and the gross matter taken together, and not simply from the elasticity and density of the fluid. If antimony in an impalpable powder, or any other heavy body,

were intimately mixed with water in a vessel of any kind, and kept in suspension by shaking or stirring them about; and if a hole were opened in the side or bottom of the vessel, the water would not run out without taking the particles of the solid body along with it. And in the same manner I conceive the solid particles that remain after the explosion of gunpowder to be carried forward with the generated elastic fluid, and, being carried forward, to retard its motion. But to return from this digression.

As it appears from these experiments that the relation of the velocities of bullets to their weights is different from that which Mr. Robins's theory supposes, it remains to inquire *what the law is which actually obtains*. And first, as the velocities bear a greater proportion to each other than the reciprocal sub-duplicate ratio of the weights of the bullets, let us see how near they come to the reciprocal sub-triplicate ratio of their weights.

Experiment.	Weight of the Bullet.	Velocity of the Bullet.				
		Computed. Recip. sub- dup. ratio.	Error of the Theory.	Actual.	Error of the Theory.	Computed. Recip. sub- trip. ratio.
92	2352	812	—	812	—	812
91	1754	940	+ 47	893	+ 2	895
90	1184	1145	+ 128	1017	+ 4	1021
89	603	1604	+ 380	1224	+ 54	1278
88	600	1608	+ 368	1240	+ 40	1280
87	354	2093	+ 805	1288	+ 239	1527
86	251	2486	+ 1056	1430	+ 282	1712
85	90	4151	+ 2042	2109	+ 301	2410

Here the velocities computed upon the last supposition appear to agree much better with the experiments than those computed upon Mr. Robins's principles; but still there is a considerable difference between the actual and the computed velocities in the three last experiments in the table.

As the powder itself is heavy, it may be considered as a weight that is put in motion along with the bullet; and if we suppose the density of the generated fluid is always uniform from the bullet to the breech, the velocity of the center of gravity of the powder, or (which amounts to the same thing) of the elastic fluid, and the gross matter generated from it will be just half as great as the velocity of the bullet. If therefore we put P to denote the weight of the powder, B the weight of the bullet, and v its initial velocity: then $B v + \frac{1}{2} P v = B + \frac{1}{2} P \times v$ will express the *momentum* of the charge at the instant when the bullet quits the bore.

If now, instead of ascertaining the relation of the velocities to the weights of the bullets, we add half the weight of the powder to the weight of the bullet and compute the velocities from the reciprocal sub-triplicate ratio of the quantity $B + \frac{1}{2} P$ in each experiment, the table will stand thus:—

Experiment.	Weight of the Bullet and half the Powder. $B + \frac{1}{2} P =$	Velocity of the Bullet.		Error of the Theory.
		Actual.	Computed.	
92	$2352 + 72\frac{1}{2}$	812	812	—
91	$1754 + 72\frac{1}{2}$	893	892	— 1
90	$1184 + 72\frac{1}{2}$	1017	1011	— 6
89	$603 + 72\frac{1}{2}$	1224	1243	+ 19
88	$600 + 72\frac{1}{2}$	1240	1245	+ 5
87	$354 + 72\frac{1}{2}$	1288	1449	+161
86	$251 + 72\frac{1}{2}$	1430	1589	+159
85	$90 + 72\frac{1}{2}$	2109	1999	—110

The agreement between the actual and computed velocities is here very remarkable, and particularly in the five first experiments, which are certainly those upon which the greatest dependence may be placed.

And hence we are enabled to determine the natures of the curves mn and gf (Fig. 16); for since B (which expresses the weight of the bullet) is as the length taken from A towards B in the several experiments, and as the velocities are as the lines drawn perpendicular to the line AB from the places where those lengths terminate, as w, u , &c. ending at the curve m, n ; if we put $a = \frac{1}{2} P$, $x = B$, and $y = wu$, then will the relation of x and y be defined by this equation $\frac{1}{\sqrt{a+x^3}} = y$. And if z be put to denote the line wr , and b the recoil when the given charge is fired without any bullet, it will be $\frac{x}{\sqrt{a+x^3}} + b = z$ in the curve gf , x being the abscissa, and z the corresponding ordinate to the curve.

In the 92d experiment half the weight of the powder ($= a$) was $72\frac{1}{2}$ grains; the weight of the bullet was 2352 grains ($= x$); the recoil ($= z$) was 32.25 inches, and with the given charge without any bullet the recoil ($= b$) was 4.4 inches; if now from these *data*, and the known weight of the bullet in each of the other experiments in this set, the recoil be computed by means of the theorem $\frac{x}{\sqrt{a+x^3}} + b = z$ we shall see how the result of those experiments agrees with this theory, thus:

Experiment.	Weight of the Bullet.	Recoil.		Difference.
		Actual.	Computed.	
92	2352	32.25	32.25	—
91	1754	27.18	27.22	+0.04
90	1184	21.92	21.85	-0.07
89	603	15.13	15.33	+0.20
88	600	15.22	15.29	+0.07
87	354	11.03	11.87	+0.84
86	251	9.62	10.21	+0.59
85	90	7.16	7.02	-0.14
84 and 93	0	4.40	4.40	—

Here the agreement of the actual and computed recoils is as remarkable as that of the actual and computed velocities in the foregoing table.

By the Figure 17 may be seen at one view the result of all these experiments and computations. The numbers upon the line *A B* (as in the Fig. 16) represent the weights of the bullets, while the lines drawn from those numbers perpendicular to *A B* on each side, and ending at the curves *m, n*, are as the velocities of the bullets in the several experiments; the line *A B* being the axis of the curves, the lengths taken from *A* to the different numbers towards *B* ($= x$) the abscissas, and the perpendiculars ($= y$) the corresponding ordinates. The ordinates to the curve *h n* are as the velocities computed from the theorem, $\frac{1}{\sqrt{a+x^3}} = y$, and the ordinates to the curve *p, n* (which is the logarithmic curve, as it is $\frac{1}{\sqrt{x}} = y$) shew the velocities computed upon Mr. Robins's principles. The curve *g f* is drawn from the theorem $\frac{x}{\sqrt{a+x^3}} + b = z$; and the actual recoil is marked upon the ordinates to this curve by large round dots, which in all the experiments except the 86th and 87th very nearly coincide with the curve.

In the Fig. 18, the numbers upon the line *A B*, taken from *A*, denote the different charges of powder used in the course of the experiments, while the ordinates to the curve *c d* express the velocities of the bullets with the vent at *o*. The lines drawn perpendicular from the line *A B* to the line *e f* represent the recoil with the several charges of powder and a leaden bullet, and the portion of those lines that is comprehended between the line *A B* and the line *g h* denotes the recoil when the given charge was fired without any bullet.

Having now shewn by experiment the relation of the velocities of bullets to their weights when care is taken to prevent entirely the loss of force by the escape of the elastic fluid through the vent, and by the windage, I shall leave it to mathematicians to determine from these *data* the properties of that fluid, or the relation of its elasticity to its density.

But before I take my leave of this subject, I would just observe that Mr. Robins is not only mistaken in the principle he assumes, respecting the relation of the elasticity of the fluid generated from gunpowder to its density, or rather the law of its action upon the bullet as it expands in the bore, but his determination of the force of gunpowder is also erroneous, even upon his own principles; for he determines its force to be 1000 times greater than the mean pressure of the atmosphere; whereas it appears, from the result of the 92d experiment, that its force is at least 1308 times greater than the mean pressure of the atmosphere, as will be evident to those who will take the trouble to make the computation.

Of an Attempt to determine the explosive Force of Aurum Fulminans, or a Comparison between its Force and that of Gunpowder.

Having provided myself with a small quantity of this wonderful powder, upon the goodness of which I could depend, I endeavored to ascertain its explosive force, by making use of it, instead of gunpowder, for discharging a bullet, and measuring, by means of the pendulum, the velocity which the bullet acquired; and concluding, from the tremendous report with which this substance explodes, that its elastic force was vastly greater than that of gunpowder, I took care to have a barrel

provided of uncommon strength, on purpose for the experiment. Its length in the bore is 13.25 inches, the diameter of the bore is 0.55 of an inch, and its weight 7 lbs. 2 oz. It is of the best iron, and was made by Wogdon; and the accuracy with which it is finished does credit to the workman.

This barrel being charged with one sixteenth of an ounce (= 27.34 grains) of *aurum fulminans*, and two leaden bullets, which, together with the leather that was put about them to make them fit the bore without windage, weighed 427 grains, it was laid upon a chaffing-dish of live coals, at the distance of about 10 feet from the pendulum, and against the center of the target of the pendulum the piece was directed.

Having secured the barrel in such a manner that its direction should not alter, I retired to a little distance, in order to be out of danger in case of an accident, where I waited, in anxious expectation, the event of the explosion.

I had remained in this situation some minutes, and almost despaired of the experiment's succeeding, when the powder exploded, but with a report infinitely less than what I expected; the noise not greatly exceeding the report of a well-charged wind-gun; and it was not till I saw the pendulum in motion, that I could be persuaded that the bullets had been discharged. I found, however, upon examination, that nothing was left in the barrel, and from the great number of small particles of revived metal that were dispersed about, I had reason to think that all the powder had exploded.

The bullets struck the pendulum nearly in the center of the target, and both of them remained in the wood; and I found, upon making the calculation, that they had

impinged against it with a velocity of 428 feet in a second.

If we now suppose that the force of *aurum fulminans* arises from the action of an elastic fluid, that is generated from it in the moment of its explosion, and that the elasticity of this fluid, or rather the force it exerts upon the bullet as it goes on to expand, is always as its density, or inversely as the space it occupies; then from the known dimensions of the barrel, — the length of the space occupied by the charge (which in this experiment was 0.47 of an inch), — and the weight and velocity of the bullets, the elastic force of this fluid, at the instant of its generation, may be determined: and I find, upon making the calculation upon these principles, that its force turns out 307 times greater than the mean elastic force of common air.

According to Mr. Robins's theory, the elastic force of the fluid generated from gunpowder in its combustion is 1000 times greater than the mean pressure of the atmosphere; the force of *aurum fulminans*, therefore, appears to be to that of gunpowder as 307 is to 1000, or as 4 is to 13 very nearly.

Of the Specific Gravity of Gunpowder.

To determine the specific gravity of gunpowder, I made use of the following method. A large glass bucket with a narrow mouth being suspended to one of the arms of a very nice balance, and counterpoised by weights put in the opposite scale, it was filled first with government powder poured in lightly, then with the same powder shaken well together, afterwards with powder and water together, and lastly with water alone, and in each case the contents of the bucket were very exactly weighed.

The specific gravity of gunpowder, as determined from these experiments, is as follows: —

Specific gravity of rain water	1.000
Government powder as it lies in a heap mixed with air	0.836
Government powder well shaken together	0.937
The solid substance of the powder	1.745.

Hence it appears that a cubic inch of government powder shaken well together weighs just 243 grains; that a cubic inch of solid powder would weigh 422 grains; and consequently, that the interstices between the particles of the powder, as it is grained for use, are nearly as great as the spaces which those particles occupy.

MISCELLANEOUS EXPERIMENTS.

Of some unsuccessful Attempts to increase the Force of Gunpowder.

It has been supposed by many, that the force of steam is even greater than that of gunpowder; and that if a quantity of water, confined in the chamber of a gun, could at once be rarefied into steam, it would impel a bullet with prodigious velocity. Several attempts have been made to shoot bullets in this manner; but I know of none that have succeeded; at least so far as to render it probable that water can ever be substituted in the room of gunpowder, for military purposes, as some have imagined.

The great difficulty that attends making these experiments lies in finding out a method by which the water can at once be rarefied and converted into elastic steam; and it occurred to me that possibly that might be effect-

ed by means of gunpowder, by confining a small quantity of water in some very thin substance, and surrounding and inclosing it with powder, and afterwards setting fire to the charge. The method I took to do this was as follows. Having procured a number of air-bladders of very small fishes, I put different quantities of water into them, from the size of a small pea to that of a small pistol bullet, and tying them up close, with some very fine thread, I hung up these little globules in the open air till they were quite dry on the outside. I then provided a number of cartridges, made of fine paper, and filled them with a known quantity of powder, equal to the customary charge for a common horseman's pistol, and having loaded such a pistol with one of them, and a fit bullet, I laid it down upon the ground, and directing it against an oaken plank, that was placed about six feet from the muzzle, I fired it off by a train, and carefully observed the recoil, and also the penetration of the bullet. I then took several of the filled cartridges that remained, and pouring out part of the powder, I put one or more of the little bladders filled with water in the center of the cartridge, and afterwards, pouring back the remaining part of the charge, confined the water in the midst of the powder.

With these cartridges and a fit bullet, the pistol was successively loaded, and being placed on the ground as before, and fired by a train, the recoil and the penetration of the bullets were observed, and I constantly found that the force of the charge was very sensibly diminished by the addition of the globule of water, and the larger the quantity of water was that was thus confined, the less was the effect of the charge; neither the recoil of the pistol, nor the penetration of the bullet, being near

equal to what they were when the given quantity of powder was fired without the water; and the report of the explosion appeared to be lessened in a still greater proportion than the recoil or penetration.

Concluding that this diminution of the force of the charge arose from the bursting of the little bladder, and the dispersion of the water among the powder before it was all inflamed, by which a great part of it was prevented from taking fire, I repeated the experiments with highly rectified spirits of wine, instead of water; but the result was nearly the same as before; the force of the charge was constantly and very sensibly diminished. I afterwards made use of ethereal oil of turpentine, and then of small quantities of quicksilver; but still with no better success. Everything I mixed with the powder, instead of increasing, served to lessen the force of the charge.

These trials were all made several months before I began the course of my experiments upon gunpowder, of which I have here given an account, and though they were altogether unsuccessful, yet I resumed the inquiry at that time, and made several new experiments, with a view to find out something that should be stronger than gunpowder, or which, when mixed with it, should increase its force.

It is well known that the elastic force of quicksilver converted into vapour is very great; this substance I made use of in my former trials, as I have just observed, but without success. I thought, however, that the failure of that attempt might possibly be owing to the quicksilver being too much in a body, by which means the fire could not act upon it to the greatest advantage; but that if it could be divided into exceeding small particles,

and so ordered that each particle might be completely surrounded by, and exposed to, the action of the flame of the powder, it would be very soon heated, and possibly might be converted into an elastic steam, or vapour, before the bullet could be sensibly removed from its place. To determine this point, I mixed 20 grains of æthiops mineral very intimately with 145 grains of powder, and charging the piece with this compound, it was loaded with a fit bullet and fired: but the force of the charge was less than that which the powder alone would have exerted, as appears by comparing the 76th and 77th experiments with the 79th.

Common *pulvis fulminans* is made of one part of sulphur, two parts of salt of tartar, and three parts of nitre; and if we may judge by the report of the explosion, the elastic force of this compound is considerably greater than that of gunpowder. I was willing to see the effect of mixing salt of tartar with gunpowder, and accordingly, having provided some of this alkaline salt in its purest state, thoroughly dry, and in a fine powder, I mixed 20 grains of it with 145 grains of gunpowder; and upon discharging the bullet with the mixture, I found that the alkaline salt had considerably lessened the force of the powder. See experiment No. 78.

I next made use of *sal ammoniacum*. That salt has been found to produce a very large quantity of gas, or elastic vapour, when exposed to heat under certain circumstances; but when 20 grains of it were mixed with a charge of gunpowder, instead of adding to its force, it diminished it very sensibly. See the 80th experiment.

Most, if not all, the metals, when they are dissolved in proper *menstrua*, cause large quantities of gas to be produced, or set at liberty; and particularly brass,

when it is dissolved in nitrous acid. Desirous of seeing if this could be done by the flame, or acid vapour of fired gunpowder, I mixed 20 grains of brass, in a very fine powder, commonly called brass dust (being the small particles of this metal that fly off from the wheel in sharpening pins), with 145 grains of powder, and with this compound and a fit bullet I loaded my barrel, and discharged it; but the experiment (No. 81) shewed that the force of the powder was not increased by the addition of the brass dust, but the contrary.

It seems probable, however, that neither brass dust nor æthiops mineral are of themselves capable of diminishing the force of gunpowder in any considerable degree, otherwise than by filling up the interstices between the grains, and obstructing the passage of the flame, and so impeding the progress of the inflammation. And hence it appears how earthy particles and impurities of all kinds are so very detrimental to gunpowder. It is not that they destroy or alter the properties of any of the bodies of which the powder is composed, but simply by obstructing the progress of the inflammation, that they lessen its force, and render it of little or no value. Too much care, therefore, cannot be taken in manufacturing gunpowder, to free the materials from all heterogeneous matter.

Of an Attempt to shoot Flame instead of Bullets.

Having often observed paper and other light bodies to come out of great guns and small-arms inflamed, I was led to try if other inflammable bodies might not be set on fire in like manner, and particularly inflammable fluids; and I thought, if this could be effected, it might be possible to project such ignited bodies by the force

of the explosion, and by that means communicate the fire to other bodies at some considerable distance ; but in this attempt I failed totally. I never could set dry tow on fire at the distance of five yards from the muzzle of my barrel. I repeatedly discharged large wads of tow and paper, thoroughly soaked in the most inflammable fluids, such as *alkohol*, *ethereal spirit of turpentine*, *balsam of sulphur*, &c., but none of them were ever set on fire by the explosion. Sometimes I discharged three or four spoonfuls of the inflammable fluid, by interposing a very thin wad of cork over the powder, and another over the fluid, but still with no better success. The fluid was projected against the wall as before, and left a mark where it hit it, but it never could be made to take fire ; so I gave up the attempt.

EXPERIMENTS

TO DETERMINE

THE FORCE OF FIRED GUNPOWDER.

NO human invention of which we have any authentic records, except, perhaps, the art of printing, has produced such important changes in civil society as the invention of *gunpowder*. Yet, notwithstanding the uses to which this wonderful agent is applied are so extensive, and though its operations are as surprising as they are important, it seems not to have hitherto been examined with that care and perseverance which it deserves. The explosion of gunpowder is certainly one of the most surprising phænomena we are acquainted with, and I am persuaded it would much oftener have been the subject of the investigations of speculative philosophers, as well as of professional men, in this age of inquiry, were it not for the danger attending the experiments; but the force of gunpowder is so great, and its effects so sudden and so terrible, that, notwithstanding all the precautions possible, there is ever a considerable degree of danger attending the management of it, as I have more than once found to my cost.

Several eminent philosophers and mathematicians, it is true, have, from time to time, employed their attention upon this curious subject; and the modern improvements in chemistry have given us a considerable insight into the cause and the nature of the explosion

which takes place in the inflammation of gunpowder, and the nature and properties of the elastic fluids generated in its combustion. But the great desideratum, — the real measure of the initial expansive force of inflamed gunpowder, — so far from being known, has hitherto been rather guessed at than determined; and no argument can be more convincing to shew our total ignorance upon that subject, than the difference in the opinions of the greatest mathematicians of the age, who have undertaken its investigation.

The ingenious Mr. Robins, who made a great number of very curious experiments upon gunpowder, and who, I believe, has done more towards perfecting the art of gunnery than any other individual, concluded, as the result of all his inquiries and computations, that the force of the elastic fluid generated in the combustion of gunpowder is 1000 times greater than the mean pressure of the atmosphere. But the celebrated mathematician Daniel Bernouilli determines its force to be not less than 10,000 times that pressure, or ten times greater than Mr. Robins made it.

Struck with this great difference in the results of the computations of these two able mathematicians, as well as with the subject itself, which appeared to me to be both curious and important, I many years ago set about making experiments upon gunpowder, with a view principally of determining the point in question, namely, *its initial expansive force* when fired; and I have ever since occasionally, from time to time, as I have found leisure and convenient opportunities, continued these inquiries.

In a paper printed in the year 1781, in the LXXI. Volume of the Philosophical Transactions, I gave an account of an experiment (No. 92), by which it ap-

peared that, calculating even upon Mr. Robins's own principles, the force of gunpowder, instead of being 1000 times, must at least be 1308 times greater than the mean pressure of the atmosphere. However, not only that experiment, but many others, mentioned in the same paper, had given me abundant reason to conclude that the principles assumed by Mr. Robins, in his treatise upon gunnery, were erroneous, and I saw no possibility of ever being able to determine the initial force of gunpowder by the methods he had proposed, and which I had till then followed in my experiments. Unwilling to abandon a pursuit which had already cost me much pains, I came to a resolution to strike out a new road, and to endeavour to ascertain the force of gunpowder by *actual measurement*, in a direct and decisive experiment.

I shall not here give a detail of the numerous difficulties and disappointments I met with in the course of these dangerous pursuits; it will be sufficient briefly to mention the plan of operations I formed, in order to obtain the end I proposed, and to give a cursory view of the train of unsuccessful experiments by which I was at length led to the discovery of the truly astonishing force of gunpowder,—a force at least *fifty thousand* times greater than the mean pressure of the atmosphere!

My first attempts were to fire gunpowder in a confined space, thinking, that when I had accomplished this, I should find means, without much difficulty, to measure its elastic force. To this end, I caused a short gun-barrel to be made, of the best wrought iron, and of uncommon strength; the diameter of its bore was $\frac{3}{4}$ of an inch, its length 5 inches, and the thickness of the metal was equal to the diameter of the bore, so that its ex-

ternal diameter was $2\frac{1}{4}$ inches. It was closed at both ends by two long screws, like the breech-pin of a musket; each of which entered two inches into the bore, leaving only a vacuity of 1 inch in length for the charge.

The powder was introduced into this cavity by taking out one of the screws or breech-pins; which being afterwards screwed into its place again, and both ends of the barrel closed up, fire was communicated to the powder by a very narrow vent, made in the axis of one of the breech-pins for that purpose. The chamber, which was 1 inch in length, and $\frac{3}{4}$ of an inch in diameter, being about half filled with powder, I expected that when the powder should be fired, the generated elastic fluid being obliged to issue out at so small an opening as the vent, which was no more than $\frac{1}{20}$ of an inch in diameter, instead of giving a smart report, would come out with something like a hissing noise; and I intended, in a future experiment, to confine the generated elastic fluid entirely by adding a valve to the vent, as I had done in some of my experiments mentioned in the preceding paper. But when I set fire to the charge (which I took the precaution to do by means of a train), instead of a hissing noise, I was surprised by a very sharp and a very loud report; and, upon examining the barrel, I found the vent augmented to at least four times its former dimensions, and both the screws loosened.

Finding, by the result of this experiment, that I had to do with an agent much more troublesome to manage than I had imagined, I redoubled my precautions.

As the barrel was not essentially injured, its ends were now closed up by two new screws, which were firmly fixed in their places by solder, and a new vent was opened in the barrel itself. As both ends of the barrel

were now closed up, it was necessary, in order to introduce the powder into the chamber, to make it pass through the vent, or to convey it through some other aperture made for that purpose. The method I employed was as follows: a hole being made in the barrel, about $\frac{2}{10}$ of an inch in diameter, a plug of steel was screwed into this hole; and it was in the center or axis of the plug that the vent was made. To introduce the powder into the chamber the plug was taken away. The vent was made conical, its largest diameter being inwards, or opening into the chamber; and a conical pin of hardened steel was fitted into it, which pin was intended to serve as a valve for closing up the vent, as soon as the powder in the chamber should be inflamed. To give a passage to the fire through the vent in entering the chamber, this pin was pushed a little inwards, so as to leave a small vacuity between its surface and the concave surface of the bore of the vent.

But notwithstanding all possible care was taken in the construction of this instrument to render it perfect in all its parts, the experiment was as unsuccessful as the former: upon firing the powder in the chamber (though it did not fill more than half its cavity), the generated elastic fluid not only forced its way through the vent, notwithstanding the valve (which appeared not to have had time to close), but it issued with such an astonishing velocity from this small aperture, that instead of coming out with a hissing noise, it gave a report nearly as sharp and as loud as a common musket. Upon examining the vent-plug and the pin, they were both found to be much corroded and damaged; though I had taken the precaution to harden them both before I made the experiment.

I afterwards repeated the experiment with a simple vent, made very narrow, and lined with gold to prevent its being corroded by the acid vapour generated in the combustion of the gunpowder; but this vent was found, upon trial, to be as little able to withstand the amazing force of the inflamed gunpowder as the others. It was so much and so irregularly corroded by the explosion, in the first experiment, as to be rendered quite unserviceable; and, what is still more extraordinary, the barrel itself, notwithstanding its amazing strength, was blown out into the form of a cask; and though it was cracked, it was not burst quite asunder, nor did it appear that any of the generated elastic fluid had escaped through the crack. The barrel in the state it was found after this experiment is still in my possession.

These unsuccessful attempts, and many others of a similar nature, of which it is not necessary to give a particular account, as they all tended to shew that the force of fired gunpowder is in fact much greater than has generally been imagined, instead of discouraging me from pursuing these inquiries, served only to excite my curiosity still more, and to stimulate me to further exertions.

These researches did not by any means appear to me as being merely speculative; on the contrary, I considered the determination of the real force of the elastic fluid generated in the combustion of gunpowder as a matter of great importance.

The use of gunpowder is become so extensive that very important mechanical improvements can hardly fail to result from any new discoveries relative to its force and the law of its action. Most of the computations that have hitherto been made relative to the action of

gunpowder have been founded upon the supposition that the elasticity of the generated fluid is, in all cases, as its density; but if this supposition should prove false, all those computations, with all the practical rules founded on them, must necessarily be erroneous; and the influence of these errors must be as extensive as the uses to which gunpowder is applied.

Having found by experience how difficult it is to confine the elastic vapour generated in the combustion of gunpowder, when the smallest opening is left by which any part of it can escape, it occurred to me that I might perhaps succeed better by closing up the powder entirely, in such a manner as to leave no opening whatever, by which it could communicate with the external air; and by setting the powder on fire, by causing the heat employed for that purpose to pass through the solid substance of the iron barrel used for confining it.

In order to make this experiment, I caused a new barrel to be constructed for that purpose; its length was 3.45 inches, and the diameter of its bore $\frac{7}{10}$ of an inch; its ends were closed up by two screws, each 1 inch in length, which were firmly and immoveably fixed in their places by solder; a vacuity being left between them in the barrel 1.45 inch in length, which constituted the chamber of the piece, and whose capacity was nearly $\frac{6}{10}$ of a cubic inch. An hole 0.37 of an inch in diameter being bored through both sides of the barrel, through the center of the chamber, and at right angles to its axis, two tubes of iron, 0.37 of an inch in diameter, the diameter of whose bore was $\frac{1}{10}$ of an inch, were firmly fixed in this hole with solder, in such a manner that while their internal openings were exactly opposite to each other, and on opposite sides of the chamber, the axes of their bores were in the same right line.

The shortest of these tubes, which projected 1.3 inch beyond the external surface of the barrel, was closed at its projecting end, or rather it was not bored quite through its whole length, $\frac{3}{10}$ of an inch of solid metal being left at its end, which was rounded off in the form of a blunt point. The longer tube, which projected 2.7 inches beyond the surface of the barrel, on the other side, and which served for introducing the powder into the chamber, was open; but it could occasionally be closed by a strong screw, furnished with a collar of oiled leather, which was provided for that purpose. The method of making use of this instrument was as follows. The barrel being laid down, or held, in an horizontal position, with the long tube upwards, the charge, which was of the very best fine-grained glazed powder, was poured through this tube into the chamber.

In doing this, care must be taken that the cavity of the short tube be completely filled with powder, and this can best be done by pouring in only a small quantity of powder at first, and then, by striking the barrel with a hammer, cause the powder to descend into the short tube. When, by introducing a priming wire, through the long tube, it is found that the short tube is full, it ought to be gently pressed together, or rammed down, by means of the priming wire, in order to prevent its falling back into the chamber upon moving the barrel out of the horizontal position. The short tube being properly filled, the rest of the charge may be introduced into the chamber, and the end of the long tube closed up by its screw.

More effectually to prevent the elastic fluid generated in the combustion of the charge from finding a passage to escape by this opening, after the charge was intro-

duced into the chamber, the cavity of the long tube was filled up with cold tallow, and the screw that closed up its end (which was $\frac{1}{2}$ an inch long, and but a little more than $\frac{1}{10}$ of an inch in diameter) was pressed down against its leather collar with the utmost force.

The manner of setting fire to the charge was as follows: a block of wrought iron about $1\frac{1}{2}$ inch square, with a hole in it, capable of receiving nearly the whole of that part of the *short tube* which projects beyond the barrel, being heated red-hot, the end of the short tube was introduced into this hole, where it was suffered to remain till the heat, having penetrated the tube, set fire to the powder it contained, and the inflammation was *from thence* communicated to the powder in the chamber.

The result of this experiment fully answered my expectations. The generated elastic fluid was so completely confined that no part of it could make its escape. The report of the explosion was so very feeble as hardly to be audible; indeed, it did not by any means deserve the name of a report, and certainly could not have been heard at the distance of twenty paces; it resembled the noise which is occasioned by the breaking of a very small glass tube.

I imagined at first that the powder had not all taken fire, but the heat of the barrel soon convinced me that the explosion must have taken place, and after waiting near half an hour, upon loosening the screw which closed the end of the long vent-tube, the confined elastic vapours rushed out with considerable force, and with a noise like that attending the discharge of an air-gun. The quantity of powder made use of in the experiment was indeed very small, not amounting to more than $\frac{1}{8}$ part of what the chamber was capable of contain-

ing; but having so often had my machinery destroyed in experiments of this sort, I began now to be more cautious.

Having found means to confine the elastic vapour generated in the combustion of gunpowder, my next attempts were to measure its force; but here again I met with new and almost insurmountable difficulties.

To measure the expansive force of the vapour, it was necessary to bring it to act upon a moveable body of known dimensions, and whose resistance to the efforts of the fluid could be accurately determined; but this was found to be extremely difficult. I attempted it in various ways, but without success. I caused a hole to be bored in the axis of one of the screws, or breech-pins, which closed up the ends of the barrel just described, and fitting a piston of hardened steel into this hole (which was $\frac{2}{10}$ of an inch in diameter), and causing the end of the piston which projected beyond the end of the barrel to act upon a heavy weight, suspended as a pendulum to a long iron rod, I hoped, by knowing the velocity acquired by the weight, from the length of the arc described by it in its ascent, to be able to calculate the pressure of the elastic vapour by which it was put in motion; but this contrivance was not found to answer, nor did any of the various alterations and improvements I afterwards made in the machinery render the results of the experiment at all satisfactory.

It was not only found almost impossible to prevent the escape of the elastic fluid by the sides of the piston, but the results of apparently similar experiments were so very different, and so uncertain, that I was often totally at a loss to account for these extraordinary variations. I was, however, at length led to suspect, what I after-

wards found abundant reason to conclude, was the real cause of these variations, and of all the principal difficulties which attended the ascertaining the force of fired gunpowder by the methods I had hitherto pursued.

It has generally been believed, after Mr. Robins, that the force of fired gunpowder consists in the action of a permanently elastic fluid, similar in many respects to common atmospheric air; which, being generated from the powder in combustion, in great abundance, and being moreover in a very compressed state, and its elasticity being much augmented by the heat (which is likewise generated in the combustion), it escapes with great violence by every avenue, and produces that loud report, and all those terrible effects, which attend the explosion of gunpowder.

But though this theory is very plausible, and seems upon a cursory view of the subject to account in a satisfactory manner for all the phænomena, yet a more careful examination will shew it to be defective. There is no doubt but the permanently elastic fluids, generated in the combustion of gunpowder, *assist* in producing those effects which result from its explosion; but it will be found, I believe, upon ascertaining the real expansive force of fired gunpowder, that this cause alone is quite inadequate to the effects actually produced; and that, therefore, the agency of some other power must necessarily be called in to its assistance.

Mr. Robins has shewn that if all the permanently elastic fluid generated in the combustion of gunpowder be compressed in the space originally occupied by the powder, and if this fluid, so compressed, be supposed to be heated to the intense heat of red-hot iron, its elastic force *in that case* will be 1000 times greater than the

mean pressure of the atmosphere ; and this, according to his theory, is the real measure of the force of gunpowder *fired in a cavity which it exactly fills.*

But what will become of this theory, and of all the suppositions upon which it is founded, if I shall be able to prove, as I hope to do in the most satisfactory manner, that the force of fired gunpowder, instead of being 1000 times, is at least 50,000 greater than the mean pressure of the atmosphere ?

For my part, I know of no way of accounting for this enormous force, but by supposing it to arise principally from the elasticity of the *aqueous vapour* generated from the powder in its combustion. The brilliant discoveries of modern chemists have taught us, that both the constituent parts of which water is composed, and even water itself, exist in the materials which are combined to make gunpowder ; and there is much reason to believe that aqueous vapour, or steam, is actually formed in its combustion. M. Lavoisier, I know, imagined that the force of fired gunpowder depends in a great measure upon the expansive force of uncombined *caloric* supposed to be let loose in great abundance during the combustion or deflagration of the powder ; but it is not only dangerous to admit the action of an agent whose *existence* is not yet clearly demonstrated, but it appears to me that this supposition is quite unnecessary, the elastic force of the heated aqueous vapour, whose existence can hardly be doubted, being quite sufficient to account for all the phænomena.

It is well known that the elasticity of aqueous vapour is considerably more augmented by any given augmentation of temperature, than that of any permanently elastic fluid whatever ; and those who are acquainted

with the amazing force of steam, when heated only to a few degrees above the boiling point, can easily perceive that its elasticity must be almost infinite, when greatly condensed and heated to the temperature of red-hot iron; and this heat it must certainly acquire in the explosion of gunpowder. But if the force of fired gunpowder arises *principally* from the elastic force of heated aqueous vapour, a cannon is nothing more than a *steam-engine* upon a peculiar construction; and upon determining the ratio of the elasticity of this vapour to its density, and to its temperature, a law will be found to obtain, very different from that assumed by Mr. Robins, in his Treatise on Gunnery. What this law really is, I do not pretend to have determined with that degree of precision which I wished; but the experiments of which I am about to give an account will, I think, demonstrate in the most satisfactory manner, not only that the force of fired gunpowder is in fact much greater than has been imagined, but also that its force consists principally in the temporary action of a fluid not permanently elastic, and consequently that all the theories hitherto proposed for the elucidation of this subject must be essentially erroneous.

The first step towards acquiring knowledge is undoubtedly that which leads us to a discovery of the falsehood of received opinions. To a diligent inquirer every common operation, performed in the usual course of practice, is an experiment, from which he endeavours to discover some new fact, or to confirm the result of former inquiries.

Having been engaged many years in the investigation of the force of gunpowder, I occasionally found many opportunities of observing, under a variety of circum-

stances, the various effects produced by its explosion; and as a long habit of meditating upon this subject rendered everything relating to it highly interesting to me, I seized these opportunities with avidity, and examined all the various phænomena with steady and indefatigable attention.

During a cruise which I made, as a volunteer, in the *Victory*, with the British fleet, under the command of my late worthy friend Sir Charles Hardy, in the year 1779, I had many opportunities of attending to the firing of heavy cannon; for though we were not fortunate enough to come to a general action with the enemy, as is well known, yet, as the men were frequently exercised at the great guns and in firing at marks, and as some of my friends in the fleet, then captains, (since made admirals,) as the Honourable Keith Stewart, who commanded the *Berwick* of 74 guns, — Sir Charles Douglas, who commanded the *Duke* of 98 guns, — and Admiral Macbride, who was then captain of the *Bien-faisant* of 64 guns, were kind enough, at my request, to make a number of experiments, and particularly by firing a greater number of bullets at once from their heavy guns than ever had been done before, and observing the distances at which they fell in the sea; I had opportunities of making several very interesting observations, which gave me much new light relative to the action of fired gunpowder. And afterwards, when I went out to America, to command a regiment of cavalry which I had raised in that country for the King's service, his Majesty having been graciously pleased to permit me to take out with me from England four pieces of light artillery, constructed under the direction of the late Lieutenant-General Desaguliers, with a large propor-

tion of ammunition, I made a great number of interesting experiments with these guns, and also with the ship guns on board the ships of war in which I made my passage to and from America.

It would take up too much time, and draw out this paper to too great a length, to give an account in detail of all these experiments, and of the various observations I have had opportunities of making from time to time, relative to this subject. I shall, therefore, only observe, at present, that the result of all my inquiries tended to confirm me more and more in the opinion, that the theory generally adopted relative to the explosion of gunpowder was extremely erroneous, and that its force is in fact much greater than is generally imagined. That the position of Mr. Robins, which supposes the inflammation and combustion of gunpowder to be so instantaneous "that the whole of the charge of a piece of ordnance is actually inflamed and converted into an elastic vapour before the bullet is sensibly moved from its place," is very far from being true; and that the ratio of the elasticity of the generated fluid to its density, or to the space it occupies as it expands, is very different from that assumed by Mr. Robins.

The rules laid down by Mr. Robins for computing the velocities of bullets from their weight, the known dimensions of the gun, and the quantities of powder made use of for the charge, may, and certainly do, very often give the velocities very near the truth; but this is no proof that the principles upon which these computations are made are just; for it may easily happen that a complication of erroneous suppositions may be so balanced that the result of a calculation founded on

them may, nevertheless, be very near the truth; and this is never so likely to happen as when, from known effects, the action of the powers which produce them are computed. For it is not in general very difficult to assume such principles as, when taken together, may in the most common known cases answer completely all the conditions required. But in such cases, if the truth be discovered with regard to any one of the assumed principles, and it be substituted in the place of the erroneous supposition, the fallacy of the whole hypothesis will immediately become evident.

As I have mentioned the experiments made with heavy artillery, as having been led by their results to form important conjectures relative to the nature of the expansion of the fluid generated in the combustion of gunpowder; it may perhaps be asked, and indeed with some appearance of reason, what the circumstances were which attended the experiments in question, which could justify so important a conclusion as that of the fallacy of the commonly received theory relative to that subject. To this I answer briefly, that in regard to the supposed instantaneous inflammation of the powder, upon which the whole fabric of this theory is built, or rather of all the computations which are grounded upon it, a careful attention to the phænomena which take place upon firing off cannon led me to suspect, or rather confirmed me in my former suspicions, that, however rapid the inflammation of gunpowder may be, its *total combustion* is by no means so sudden as this theory supposes. When a heavy cannon is fired in the common way, that is, when the vent is filled with loose powder, and the piece is fired off with a match, the time employed in the passage of the inflammation through the vent into the chamber of

the piece is perfectly sensible, and this time is evidently shorter after the piece has been heated by repeated firing. With the same charge, the recoil of a gun (and consequently the velocity of its bullet) is greater after the gun has been heated by repeated firing than when it is cold. The velocity of the bullet is considerably greater when the cannon is fired off with a vent tube, or by firing a pistol charged with powder into the open vent, than when the vent is filled with loose powder. The velocity of two, three, or more fit bullets discharged at once from a piece of ordnance, compared to the velocity of one single bullet discharged by the same quantity of powder from the same cannon, is greater than it ought to be according to the theory. Considerable quantities of powder are frequently driven out of cannon and other fire-arms *unconsumed*. The manner in which the smoke of gunpowder rises in the air, and is gradually dissolved and rendered invisible, shews it to partake of the nature of steam. But not to take up too much time with these general observations, I shall proceed to give an account of experiments, the results of which will be considered as more conclusive.

Having found it impossible to measure the elastic force of fired gunpowder with any degree of precision by any of the methods before mentioned, I totally changed my plan of operations, and instead of endeavouring to determine its force by causing the generated elastic fluid to act upon a moveable body through a determined space, I set about contriving an apparatus in which this fluid should be made to act, by a determined surface, against a weight, which, by being increased at pleasure, should at last be such as would just be able to confine it, and which in that case would just counterbalance, and consequently *measure*, its elastic force.

The idea of this method of determining the force of fired gunpowder occurred to me many years ago ; but a very expensive and troublesome apparatus being necessary in order to put it in execution, it was not till the year 1792, when, being charged with the arrangement of the army of his most Serene Highness the ELECTOR PALATINE, reigning Duke of Bavaria, and having all the resources of the military arsenal, and a number of very ingenious workmen at my command, with the permission and approbation of his most Serene Electoral Highness, I set about making the experiments which I shall now describe ; and as they are not only important in themselves and in their results, but as they are, I believe, the first of the kind that have been made, I shall be very particular in my account of them, and also of the apparatus used in making them.

One difficulty being got over, that of setting fire to the powder without any communication with the external air, by causing the heat employed for that purpose to pass through the solid substance of the barrel, it only remained to apply such a weight to an opening made in the barrel as the whole force of the generated elastic fluid should not be able to lift or displace ; but in doing this many precautions were necessary. For, first, as the force of gunpowder is so very great, it was necessary to employ an enormous weight to confine it ; for although by diminishing the size of the opening the weight would be lessened in the same proportion, yet it was necessary to make this opening of a certain size, otherwise the experiments would not have been satisfactory ; and it was necessary to make the support or base upon which the barrel was placed very massy and solid, to prevent the errors which would unavoidably have arisen from its want of solidity or from its elasticity.

The annexed drawings will give a complete idea of the whole apparatus made use of in these experiments. A (Fig. 1) is a solid block of very hard stone, 4 feet 4 inches square, placed upon a bed of solid masonry, which descended 6 feet below the surface of the earth. Upon this block of stone, which served as a base to the whole machinery, was placed the barrel B of hammered iron, upon its support C, which is of cast brass, or rather of gun-metal; which support was again placed upon a circular plate of hammered iron D, 8 inches in diameter, and $\frac{3}{4}$ of an inch thick, which last rested upon the block of stone. The opening of the bore of the barrel (which was placed in a vertical position, and which was just $\frac{1}{4}$ of an inch in diameter) was closed by a solid hemisphere E of hardened steel, whose diameter was 1.16 inch; and upon this hemisphere the weight F, made use of for confining the elastic fluid generated from the powder in its combustion, reposed. This weight (which in some of the most interesting experiments was a brass cannon, a heavy twenty-four pounder, placed vertically upon its cascabel), being fixed to the timbers G G which formed a kind of carriage for it, was moveable up and down; the ends of these timbers being moveable in grooves cut in the vertical timbers K K, which being fixed below in holes made to receive them in the block of stone, and above by a cross-piece L, were supported by braces and iron clamps made fast to the thick walls of the building of the arsenal.

This weight was occasionally raised and lowered in the course of the experiments (in placing and removing the barrel), by means of a very strong lever, which is omitted in the drawing to make it less complicated. The barrel, a section of which is represented in Fig. 2 of

its natural size, is 2.78 inches long, and 2.82 inches in diameter at its lower extremity, where it reposes upon its supporter, but something less above, being somewhat diminished and rounded off at its upper extremity. Its bore, which, as I have already observed, is $\frac{1}{4}$ of an inch in diameter, is 2.13 inches long, and it ends in a very narrow opening below, not more than 0.07 of an inch in diameter, and 1.715 inch long, which forms the vent (if I may be permitted to apply that name to a passage which is not open at both ends), by which the fire is communicated to the charge. From the center of the bottom of the barrel there is a projection of about 0.45 of an inch in diameter, and 1.3 inch long, which forms the vent tube V. Fig. 3 is a view of an iron ball W, which, being heated red-hot, and being applied to the vent tube by means of an hole O, made in it for that purpose, fire is communicated through the solid substance of the vent tube to the powder it contains, and from thence to the charge.

Fig. 4, which is drawn on a scale of two inches to the inch, or half the real size of the machinery, shews how the barrel B was placed upon its support C, how this last was placed upon its circular plate of iron D, and how the red-hot iron ball W was applied to the vent tube V. This ball is managed by means of a long handle *h*, of iron, and being introduced through a circular opening *g*, in the support, and applied to the vent tube V, is kept in its place by means of a wedge, or rather lever *l*, whose external end is represented in the drawing as being broken off, to save room. The circular opening in front of the support is seen in front, and consequently more distinctly, in the drawing, Fig. 1. In this drawing the end of the vent tube may be likewise discovered through

this opening ; but as it was necessary, in order to introduce all the parts of this machinery, to make the drawing upon a very small scale, it was not possible to express all the smaller parts with that distinctness which I wished. The other figures which are added, in which the parts are expressed separately, and upon a larger scale, will, it is hoped, supply this defect.

The stand, or support, as I have called it, upon which the barrel was placed, is circular, and in order that it might be united more firmly to the plate of iron upon which it reposes, this plate is furnished with a cylindrical projection *p*, 1 inch long and $1\frac{1}{2}$ in diameter, which enters a hole made in the bottom of the stand to receive it.

Fig. 5 is a view of the barrel from above, in which the projecting screws, or rather cylinders, are seen, by which the hemisphere E, Fig. 2, which closed the end of the barrel, was kept in its place. Two of these screws 1, 2, are seen in the figures 2 and 4. The smaller circle *a b*, Fig. 5, shews the diameter of a circular plate of gold, which was let into the end of the barrel, being firmly fixed to the iron with solder ; and the larger circle *c d* represents a circular piece of oiled leather, which was placed between the end of the barrel and the hemisphere which rested upon it.

The end of the barrel was covered with gold, in order to prevent, as much as possible, its being corroded by the elastic vapour, which, when the weight is not heavy enough to confine it, escapes between the end of the barrel and the flat surface of the hemisphere ; but even this precaution was not found to be sufficient to defend the apparatus from injury. The sharp edge of the barrel, at the mouth of the bore, was worn away almost

immediately, and even the flat surface of the hemisphere, notwithstanding it was of hardened steel and very highly polished, was sensibly corroded. This corrosion of the mouth of the bore, by which the dimensions of the surface upon which the generated elastic fluid acted were rendered very uncertain, would alone have been sufficient to have rendered all my attempts to determine the force of fired gunpowder abortive, had I not found means to remedy the evil. The method I employed for this purpose was as follows. Having provided some pieces of very good compact sole-leather, I caused them to be beaten upon an anvil with a heavy hammer to render them still more compact; and then, by means of a machine made for that purpose, cylindric stoppers, of the same diameter precisely as the bore of the barrel, and 0.13 of an inch in length (that is to say, equal in length to the thickness of the leather), were formed of it; and one of these stoppers, which had previously been greased with tallow, being put into the mouth of the piece after the powder had been introduced, and being forced into the bore till its upper end coincided with the end of the barrel, upon the explosion taking place, this stopper (being pressed on the one side by the generated elastic fluid, and on the other by the hemisphere, loaded with the whole weight employed to confine the powder) so completely closed the bore that when the force of the powder was not sufficient to raise the weight to such a height that the stopper was actually blown out of the piece, not a particle of the elastic fluid could make its escape. And in those cases in which the weight was actually raised, and the generated elastic fluid made its escape, as it did not corrode the barrel in any other part but just *at the very extremity of the bore*, the

.

-

experiment by which the weight was ascertained, which was just able to counterbalance the pressure of the generated elastic fluid, was in no wise vitiated, either by the increased diameter of the bore at its extremity or by any corrosion of the hemisphere itself; for as long as the bore retained its form and its dimensions in that part to which the efforts of the elastic fluid were confined, that is, in that part of the bore immediately in contact with the lower part of the stopper, the experiment could not be affected by any imperfection of the bore either above or below.

In the figures 2 and 4 this stopper is represented in its place, and Fig. 6 shews the plan, and Fig. 7 the profile of one of these stoppers of its full size. Fig. 8 shews a small, but very useful instrument, employed in introducing these stoppers into the bore, and more especially in occasionally extracting them; it resembles a common cork-screw, only it is much smaller.

In the figure (where it is shewn in its full size) it is represented screwed into a stopper. Fig. 9 shews the plan, and Fig. 10 a side view, of the full size, of the hemisphere of hardened steel, by which the end of the barrel was closed. In the figures 2 and 4 the barrel is represented as being about half filled with powder.

Presuming that what has been already said, together with the assistance of the annexed drawings, will be sufficient to give a perfect idea of all the different parts of this apparatus, I shall now proceed to give an account of the experiments, which, from time to time, have been made with it. And in order to render these details as intelligible as possible, and to shew the results of all these inquiries in a clear and satisfactory manner, I shall first give a brief account of the manner in

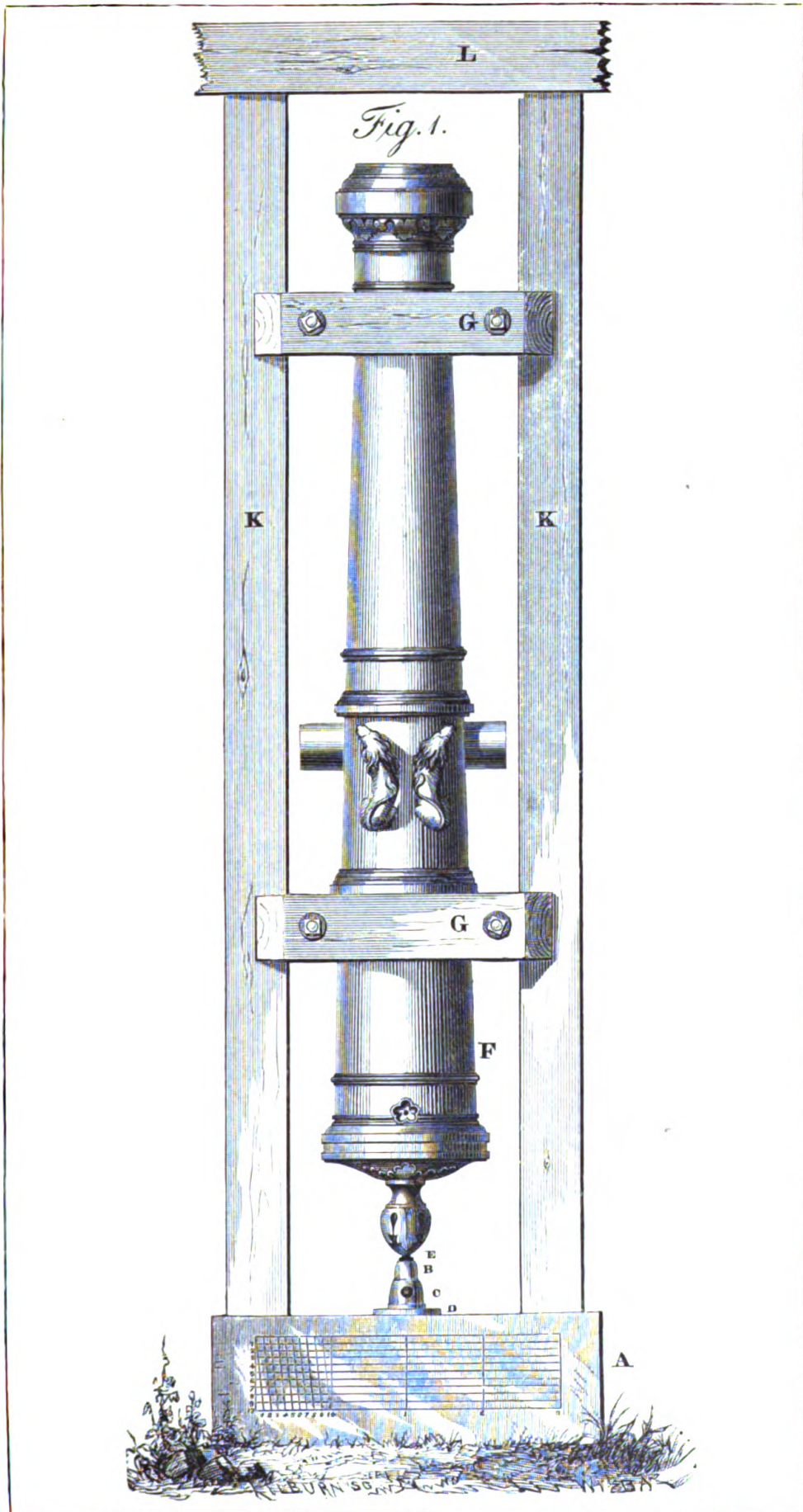



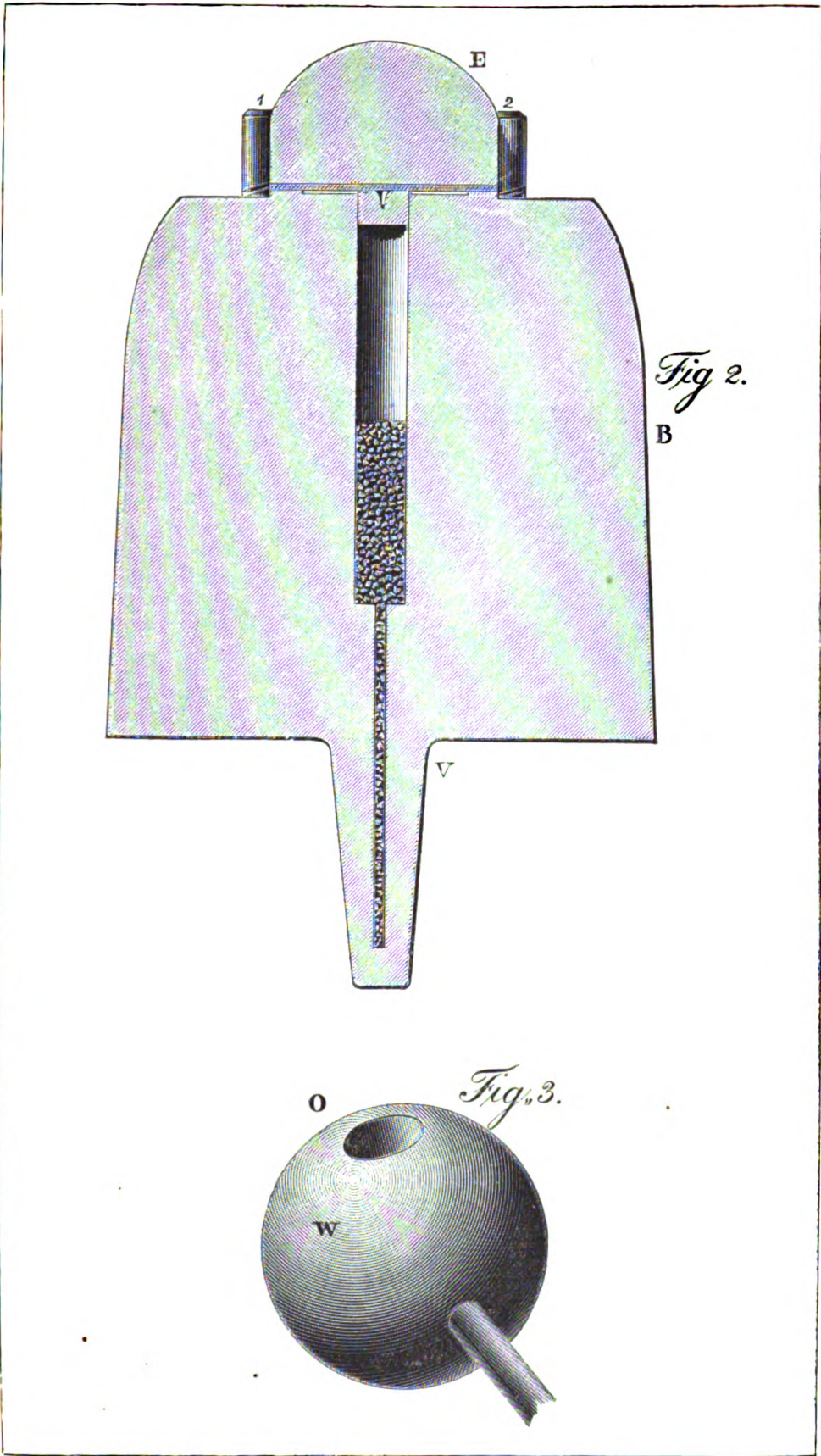



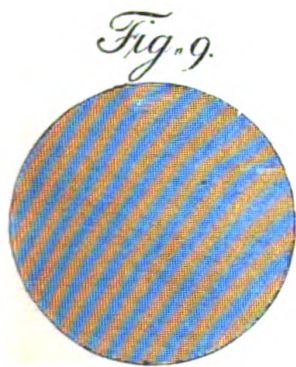
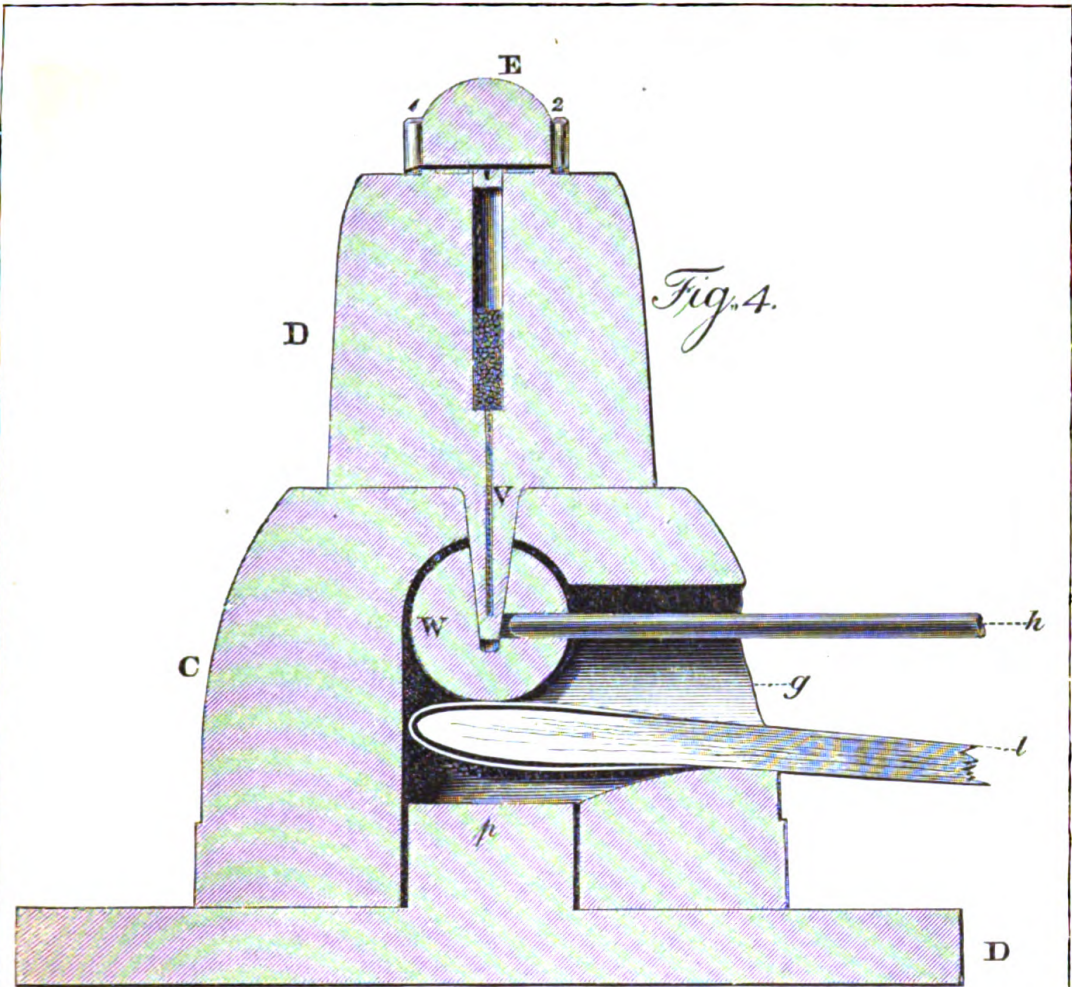



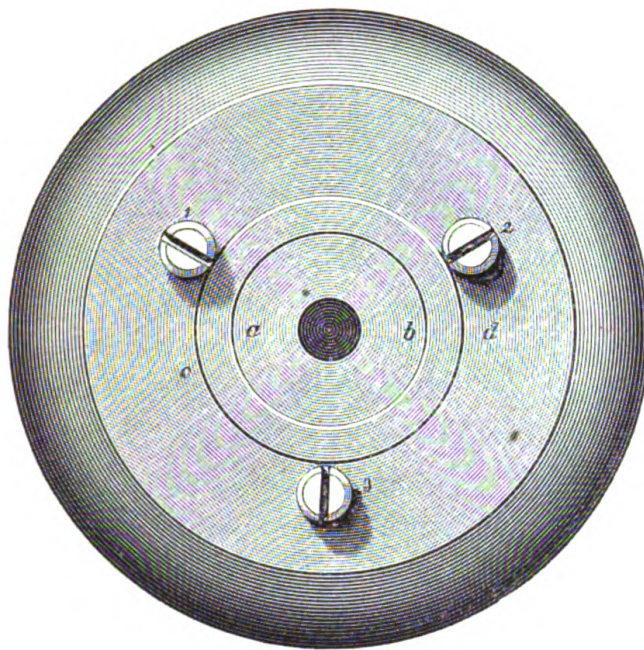

Fig. 5.

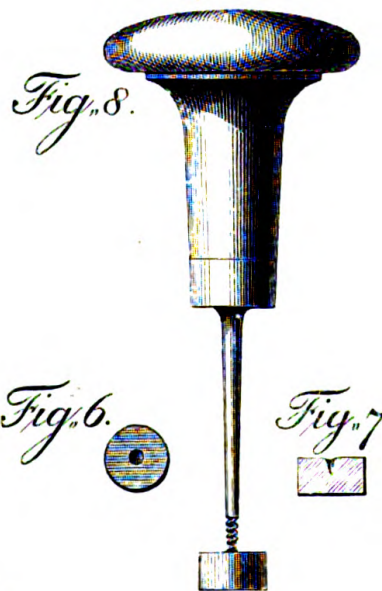

Fig. 8.



Fig. 6.



Fig. 7.



which the experiments were made ; of the various precautions used ; and the particular appearances which were observed in the prosecution of them.

The powder made use of in these experiments was of the best quality, being that kind called *poudre de chasse* by the French, and very fine grained ; and it was all taken from the same parcel. Care was taken to dry it very thoroughly, and the air of the room in which it was weighed out for use was very dry. The weights employed for weighing the powder were German apothecary's grains, 104.8 of which make 100 grains Troy. I have reduced the weights employed to confine the elastic vapour generated in the combustion of the powder from Bavarian pounds, in which they were originally expressed, to pounds avoirdupois. The measures of length were all taken in English feet and inches. The experiments were all made in the open air, in the court-yard of the arsenal at Munich ; and they were all made in fair weather, and between the hours of nine and twelve in the forenoon, and two and five in the afternoon ; but the barrel was always charged, and the extremity of the bore closed by its leather stopper, in the room where the powder was weighed. In placing the barrel upon the block of stone, great care was taken to put it exactly under the center of gravity of the weight employed to confine the generated elastic vapour. Upon applying the red-hot ball to the vent tube, and fixing it in its place by its lever which supported it, the explosion very soon followed.

When the force of the generated elastic vapour was sufficient to raise the weight, the explosion was attended by a very sharp and surprisingly loud report ; but when the weight was not raised, as also when it was only a

little moved, but not sufficiently to permit the leather stopper to be driven quite out of the bore, and the elastic fluid to make its escape, the report was scarcely audible at the distance of a few paces, and did not at all resemble the report which commonly attends the explosion of gunpowder. It was more like the noise which attends the breaking of a small glass tube than anything else to which I can compare it.

In many of the experiments in which the elastic vapour was confined, this feeble report attending the explosion of the powder was immediately followed by another noise, totally different from it, which appeared to be occasioned by the falling back of the weight upon the end of the barrel, after it had been a little raised, but not sufficiently to permit the leather stopper to be driven quite out of the bore. In some of these experiments, a very small part only of the generated elastic fluid made its escape; in these cases the report was of a peculiar kind, and though perfectly audible at some considerable distance, yet not at all resembling the report of a musket. It was rather a very strong, sudden hissing, than a clear, distinct, and sharp report.

Though it could be determined with the utmost certainty, by the report of the explosion, whether any part of the generated elastic fluid had made its escape, yet for still greater precaution a light collar of very clean cotton wool was placed around the edge of the steel hemisphere, where it reposed upon the end of the barrel, which could not fail to indicate, by the black color it acquired, the escape of the elastic fluid, whenever it was strong enough to raise the weight by which it was confined sufficiently to force its way out of the barrel.

Though the end of the barrel, at the mouth of the

bore, was covered with a circular plate of gold, in order the better to defend the mouth of the bore against the effects of the corrosive vapour, yet this plate being damaged in the course of the experiments (a piece of it being blown away), the remainder of it was removed; and it was never after thought necessary to replace it by another.

When this plate of gold was taken away, the length of the barrel was of course diminished as much as the thickness of this plate amounted to, which was about $\frac{1}{400}$ part of an inch; but in order that even this small diminution of the length of the barrel might have no effect on the result of the experiments, its bore was deepened $\frac{1}{400}$ of an inch when this plate was removed, so that the capacity of the bore remained the same as before.

After making use of a great variety of expedients, the best and most convenient method of closing the end of the bore, and defending the flat surface of the steel hemisphere from the corroding vapours, was found to be this: first, to cover the end of the bore with a circular plate of thin oiled leather, then to lay upon this a very thin circular plate of hammered brass, and upon this brass plate the flat surface of the hemisphere. When the elastic fluid made its escape, a part of the leather was constantly found to have been torn away, but never in more places than one, that is to say, always on one side only.

What was very remarkable in all those experiments in which the generated elastic vapour was completely confined, was the small degree of expansive force which this vapour appeared to possess after it had been suffered to remain a few minutes, or even only a few seconds, con-

fined in the barrel; for, upon raising the weight by means of its lever, and suffering this vapour to escape, instead of escaping with a loud report, it rushed out with a hissing noise hardly so loud or so sharp as the report of a common air gun; and its efforts against the leathern stopper, by which it assisted in raising the weight, were so very feeble as not to be sensible. Upon examining the barrel, however, this diminution of the force of the generated elastic fluid was easily explained; for what was undoubtedly in the moment of the explosion in the form of an elastic fluid was now found transformed into a *solid body* as hard as a stone! It may easily be imagined how much this unexpected appearance excited my curiosity; but, intent on the prosecution of the main design of these experiments, the ascertaining the force of fired gunpowder, I was determined not to permit myself to be enticed away from it by any extraordinary or unexpected appearances, or accidental discoveries, however alluring they might be; and, faithful to this resolution, I postponed the examination of this curious phænomenon to a future period; and since that time I have not found leisure to engage in it. I think it right, however, to mention in this place such cursory observations as I was able, in the midst of my other pursuits, to make upon this subject; and it will afford me sincere pleasure, if what I have to offer should so far excite the curiosity of philosophers as to induce some one who has leisure, and the means of pursuing such inquiries with effect, to precede me in the investigation of this interesting phænomenon; and as the subject is certainly not only extremely curious in itself, but bids fair to lead to other and very important discoveries, I cannot help flattering myself that some attention will be paid to it.

I have said that the solid substance into which the elastic vapour generated in the combustion of gunpowder was transformed was *as hard as a stone*. This I am sensible is but a vague expression; but the fact is, that it was very hard, and so firmly attached to the inside of the barrel, and particularly to the inside of the upper part of the vent tube, that it was always necessary, in order to remove it, to make use of a drill, and frequently to apply a considerable degree of force. This substance, which was of a black colour, or rather of a dirty grey, which changed to black upon being exposed to the air, had a pungent, acrid, alkaline taste, and smelt like liver of sulphur. It attracted moisture from the air with great avidity. Being moistened with water, and spirit of nitre being poured upon it, a strong effervescence ensued, attended by a very offensive and penetrating smell. Nearly the whole quantity of matter of which the powder was composed seemed to have been transformed into this substance; for the quantity of elastic fluid which escaped upon removing the weight was very inconsiderable; but this substance was *no longer gunpowder*; it was not even inflammable. What change had it undergone? what could it have lost? It is very certain that the barrel was considerably heated in these experiments. Was this occasioned by the *caloric*, disengaged from the powder in its combustion, making its escape through the iron? And is this a proof of the existence of *caloric*, considered as a fluid *sui generis*; and that it actually enters into the composition of inflammable bodies, or of pure air, and is necessary to their combustion? I dare not take upon me to decide upon such important questions. I once thought that the heat acquired by a piece of ordnance in being fired arose

from the vibration or friction of its parts, occasioned by the violent blow it received in the explosion of the powder; but I acknowledge fairly, that it does not seem to be possible to account in a satisfactory manner for the very considerable degree of heat which the barrel acquired in these experiments, merely on that supposition.

That this hard substance, found in the barrel after an experiment in which the generated elastic vapour had been completely confined, was actually in a fluid or elastic state in the moment of the explosion, is evident from hence, that in all those cases in which the weight was raised, and the stopper blown out of the bore, nothing was found remaining in the barrel. It was very remarkable that this hard substance was not found distributed about in all parts of the barrel indifferently, but there was always found to be more of it near the middle of the length of the bore, than at either of its extremities; and the upper part of the vent tube in particular was always found quite filled with it. It should seem from hence, that it attached itself to those parts of the barrel which were soonest cooled; and hence the reason, most probably, why none of it was ever found in the lower part of the vent tube, where it was kept hot by the red-hot ball by which the powder was set on fire.

I found by a particular experiment, that the gunpowder made use of, when it was well shaken together, occupied rather less space in any given measure than the same weight of water; consequently, when gunpowder is fired in a confined space which it fills, the density of the generated elastic fluid must be at least equal to the density of water. The real specific gravity of the solid

grains of gunpowder, determined by weighing them in air, and in water, is to the specific gravity of water as 1.868 to 1.000. But if a measure whose capacity is one cubic foot hold 1000 ounces of water, the same measure will hold just 1077 ounces of fine grained gunpowder, such as I made use of in my experiments; that is to say, when it is well shaken together. When it was moderately shaken together, I found its weight to be exactly equal to that of an equal volume, or rather measure, of water. But it is evident that the weight of any given measure of gunpowder must depend much upon the forms and sizes of its grains.

I shall add only one observation more, relative to the particular appearances which attended the experiments in which the elastic vapour generated in the combustion of gunpowder was confined, and that is with regard to a curious effect produced upon the inferior flat surface of the leathern stopper, where it was in contact with the generated elastic vapour. Upon removing the stopper, its lower flat surface appeared entirely covered with an extremely white powder, resembling very light white ashes, but which almost instantaneously changed to the most perfect black colour upon being exposed to the air.

The sudden change of colour in this substance, upon its being exposed to the air, has led me to suspect that the solid matter found in the barrel was not originally black, but that it became black merely in consequence of its being exposed to the air. The dirty gray colour it appeared to have immediately on its being drilled out of the cavity of the bore, where it had fixed itself, seems to confirm this suspicion. An experiment made with a very strong glass barrel would not only decide this

question, but would most probably render the experiment peculiarly beautiful and interesting on other accounts; and I have no doubt but a barrel of glass might be made sufficiently strong to withstand the force of the explosion. Whether it would be able to withstand the sudden effects of the heat, I own I am more doubtful; but as the subject is so very interesting, I think it would be worth while to try the experiment. Perhaps the apparatus might be so contrived as to set fire to the powder by the solar rays, by means of a common burning glass; but even if that method should fail, there are others equally unexceptionable, which might certainly be employed with success; and it is hardly possible to imagine anything more curious than an experiment of this kind would be if it were successful.

But to proceed to the experiments by which I endeavoured to ascertain the force of fired gunpowder. All the parts of the apparatus being ready, it was in the autumn of the year 1792 that the first experiment was made.

The barrel being charged with 10 grains of powder (its contents when quite full amounting to about 28 grains), and the end of the barrel being covered by a circular piece of oiled leather, and the flat side of the hemisphere being laid down upon this leather, and a heavy cannon, a twenty-four pounder, weighing 8081 lbs. avoirdupois, being placed upon its cascabel in a vertical position, upon this hemisphere, in order to confine by its weight the generated elastic fluid, the heated iron ball was applied to the end of the vent tube; and I had waited but a very few moments in anxious expectation of the event, when I had the satisfaction of observing that the experiment had succeeded.

The report of the explosion was extremely feeble, and so little resembling the usual report of the explosion of gunpowder, that the by-standers could not be persuaded that it was anything more than the cracking of the barrel, occasioned merely by its being heated by the red-hot ball; yet, as I had been taught by the result of former experiments not to expect any other report, and as I found upon putting my hand upon the barrel that it began to be sensibly warm, I was soon convinced that the powder must have taken fire; and after waiting four or five minutes, upon causing the weight which rested upon the hemisphere to be raised, the confined elastic vapour rushed out of the barrel. Upon removing the barrel and examining it, its bore was found to be choked up by the solid substance which I have already described, and from which it was with some difficulty that it was freed, and rendered fit for another experiment.

The extreme feebleness of the report of the explosion, and the small degree of force with which the generated elastic fluid rushed out of the barrel upon removing the weight which had confined it, had inspired my assistants with no very favourable idea of the importance of these experiments. I had seen, indeed, from the beginning, by their looks, that they thought the precautions I took to confine so inconsiderable a quantity of gunpowder as the barrel could contain perfectly ridiculous; but the result of the following experiment taught them more respect for an agent, of whose real force they had conceived so very inadequate an idea.

In this second experiment, instead of 10 grains of powder, the former charge, the barrel was now quite filled with powder, and the steel hemisphere, with its

oiled leather under it, was pressed down upon the end of the barrel by the same weight which was employed for that purpose in the first experiment, namely, a cannon, weighing 8081 lbs.

In order to give a more perfect idea of the result of this important experiment, it may not be amiss to describe more particularly one of the principal parts of the apparatus employed in it, I mean the barrel. This barrel (which though similar to it in all respects, was not the same that has already been described) was made of the best hammered iron, and was of uncommon strength. Its length was $2\frac{3}{4}$ inches; and though its diameter was also $2\frac{3}{4}$ inches, the diameter of its bore was no more than $\frac{1}{4}$ of an inch, or less than the diameter of a common goose quill. The length of its bore was 2.5 inches. Its diameter being $2\frac{3}{4}$ inches, and the diameter of its bore only $\frac{1}{4}$ of an inch, the thickness of the metal was $1\frac{1}{4}$ inch; or it was 5 times as thick as the diameter of its bore.

The charge of powder was extremely small, amounting to but little more than $\frac{1}{10}$ of a cubic inch; not so much as would be required to load a small pocket pistol, and not *one-tenth part* of the quantity frequently made use of for the charge of a common musket.

I should be afraid to relate the result of this experiment, had I not the most indisputable evidence to produce in support of the facts. This inconsiderable quantity of gunpowder, when it was set on fire by the application of the red-hot ball to the vent tube, exploded with such inconceivable force as to *burst the barrel asunder* in which it was confined, notwithstanding its enormous strength; and with such a loud report as to alarm the whole neighbourhood.

It is impossible to describe the surprise of those who were spectators of this phænomenon. — They literally turned pale with affright and astonishment, and it was some time before they could recover themselves.

The barrel was not only completely burst asunder, but the two halves of it were thrown upon the ground in different directions : one of them fell close by my feet, as I was standing near the machinery to observe more accurately the result of the experiment. Though I thought it possible that the weight might be raised, and that the generated elastic vapour would make its escape, yet the bursting of the barrel was totally unexpected by me. It was a new lesson to teach me caution in these dangerous pursuits.

It affords me peculiar satisfaction in laying these accounts before the Public to be able to produce the most respectable testimony of their authenticity.

My friend, Sir Charles Blagden, formerly Secretary of the Royal Society, visited Munich in the summer of the year 1793, in his return from Italy ; and though I was then absent (travelling for the recovery of my health), yet, by my directions, he was not only shewn every part of the apparatus made use of in these experiments, but several experiments were actually repeated in his presence ; and he was kind enough to take with him to England one half of the barrel which was burst in the experiment just mentioned, which, at my request, he has deposited in the Museum of the Society, and which, I flatter myself, will be looked upon as an unequivocal proof of my discoveries relative to the amazing force of the elastic vapour generated in the combustion of gunpowder.

When the amazing strength of this barrel is con-

sidered, and the smallness of the capacity of its bore, it appears almost incredible, that so small a quantity of powder as that which was employed in the experiment could burst it asunder.

But without insisting on the testimony of several persons of respectable character, who were eye witnesses of the fact, and from whom Sir Charles Blagden received a verbal account, in detail, of all the circumstances attending the experiment, I fancy I may very safely rest my reputation upon the silent testimony which this broken instrument will bear in my favour; much doubting whether it be in the power of art to burst asunder such a mass of solid iron by any other means than those I employed.

Before I proceed to give an account of my subsequent experiments upon this subject, I shall stop here, for a moment, to make an estimate — from the known strength of *iron*, and the area of the fracture of the barrel — of the real force employed by the elastic vapour to burst it.

In a course of experiments upon the strength of various bodies, which I began many years ago, and an account of which I intend at some future period to lay before the Public,* I found, by taking the mean of the results of several experiments, that a cylinder of good

* Since writing the above, I have met with a misfortune which has put it out of my power to fulfil this promise. On my return to England from Germany in October, 1795, after an absence of eleven years, I was stopped in my post-chaise, in St. Paul's church-yard, in London, at six o'clock in the evening, and robbed of a trunk which was behind my carriage, containing all my private papers, and my original notes and observations on philosophical subjects. By this cruel robbery I have been deprived of the fruits of the labours of my whole life; and have lost all that I held most valuable. This most severe blow has left an impression on my mind, which I feel that nothing will ever be able entirely to remove.

It is the more painful to me, as it has clouded my mind with suspicions that never can be cleared up.

tough hammered iron, the area of whose transverse section was only $\frac{3}{1600}$ of an inch, was able to sustain a weight of 119 lbs. avoirdupois without breaking. This gives 63,466 lbs. for the weight which a cylinder of the same iron whose transverse section is one inch would be able to sustain without being broken.

The area of the fracture of the barrel before mentioned was measured with the greatest care, and was found to measure very exactly $6\frac{1}{2}$ superficial inches. If now we suppose the iron of which this barrel was formed to be as strong as that whose strength I determined (and I have no reason to suspect it to be of an inferior quality), in that case the force actually employed in bursting the barrel must have been equal to the pressure of a weight of 412,529 lbs. For the resistance or cohesion of one inch is to 63,466 lbs. as that of $6\frac{1}{2}$ inches to 412,529 lbs.; and this force, so astonishingly great, was exerted by a body which weighed less than 26 grains Troy, and which acted in a space that hardly amounted to $\frac{1}{10}$ of a cubic inch.

To compare this force exerted by the elastic vapour generated in the combustion of gunpowder, and by which the barrel was burst, to the pressure of the atmosphere, it is necessary to determine the area of a longitudinal section of the bore of the piece. Now the diameter of the bore being $\frac{1}{4}$ of an inch, and its length (after deducting 0.15 of an inch for the length of the leathern stoppers) 2 inches, the area of its longitudinal section turns out to have been $\frac{1}{2}$ an inch. And if now we assume the mean pressure of the atmosphere = 15 lbs. avoirdupois for each superficial inch, this will give $7\frac{1}{2}$ lbs. for that upon a surface = $\frac{1}{2}$ inch, equal to the area of a longitudinal section of the bore of the barrel.

But we have just found that the force actually exerted by the elastic vapour in bursting the barrel, amounted to 412,529 lbs.; this force was therefore 55,004 times greater than the mean pressure of the atmosphere. For it is as $7\frac{1}{2}$ lbs. to 1 atmosphere, so 412,529 lbs. to 55,004 atmospheres.

Thinking it might perhaps be more satisfactory to know the *real strength* of the identical iron of which the barrel used in the before-mentioned experiment was constructed, rather than to rest the determination of the strength of the barrel upon the decision of the strength of iron taken from another parcel, and which very possibly might be of a different quality, since writing the above, I have taken the trouble to ascertain the strength of the iron of which the barrel was made, which was done in the following manner. Having the one half of the barrel still in my possession, I caused small pieces, 2 inches long, and about $\frac{1}{8}$ of an inch square, to be cut out of the solid block of metal, in the direction of its length, with a fine saw; and these pieces being first made round in their middle by filing, and then by turning in a lathe with a very sharp instrument, were reduced to such a size as was necessary, in order to their being pulled asunder in my machine for measuring the strength of bodies. In this machine the body to be pulled asunder is held fast by two strong vices, the one fastened to the floor, and the other suspended to the short arm of a Roman balance, or common steel-yard; and, in order that the bodies so suspended may not be injured by the jaws of the vices, so as to be weakened and to vitiate the experiments, they are not made cylindrical, but they are made larger at their two ends where they are held by the vices, and from thence their

diameters were gradually diminished toward the middle of their lengths, where their measures were taken, and where they never failed to break.

As I had found by the results of many experiments, which I had before made upon the strength of the various metals, that iron, as well as all other metals, is rendered much stronger by hammering, I caused those pieces of the barrel which were prepared for these experiments to be separated from the solid block of metal, and reduced to their proper sizes, by sawing, filing, and turning, and without ever receiving a single blow of a hammer ; so that there is every reason to believe that the strength of the iron, as determined by the experiments, may safely be depended on. The results of the experiments were as follows : —

Exp.	Diameter of the Cylinder at the Fracture.	Area of a transverse section of the Cylinder at the Fracture.	Weight required to break it.	Weight required to break 1 inch of this Iron.
	Inch.	Inch.	Lbs. avoirdupois.	Lbs. avoirdupois.
1	$\frac{50}{1000}$	$\frac{1}{509.29}$	123.18	62,737
2	$\frac{60}{1000}$	$\frac{1}{353.68}$	182.00	64,366
3	$\frac{66}{1000}$	$\frac{1}{292.03}$	220.75	64,526
4	$\frac{76}{1000}$	$\frac{1}{220.07}$	277.01	61,063
(Number of Experiments = 4.)				252,692
Mean				63,173

If now we take the strength of the iron of which the barrel was composed, as here determined by actual experiments, and compute the force required to burst the barrel, it will be found equal to the pressure of a weight of $410,624\frac{1}{2}$ lbs. instead of 436,800 lbs. as before determined. For it is the resistance or force of cohesion of 1 inch of this iron to 63,173 lbs., as that of $6\frac{1}{2}$ inches (the area of the fracture of the barrel) to $410,624\frac{1}{2}$ lbs.

And this weight turned into atmospheres, in the manner above described, gives 54,750 atmospheres for the measure of the force which must have been exerted by the elastic fluid in bursting the barrel. But this force, enormous as it may appear, must still fall short of the real initial force of the elastic fluid generated in the combustion of gunpowder, before it has begun to expand; for it is more than probable that the barrel was in fact burst before the generated elastic fluid had exerted all its force, or that this fluid would have been able to have burst a barrel still stronger than that used in the experiment. But I wave these speculations in order to hasten to more interesting and more satisfactory investigations.

Passing over in silence a considerable number of promiscuous experiments, which, having nothing particularly remarkable in their results, could throw no new light upon the subject, I shall proceed immediately to give an account of a regular set of experiments, undertaken with a view to the discovery of certain determined facts, and prosecuted with unremitting perseverance.

These experiments were made by my directions, under the immediate care of Mr. Reichenbach, commandant of the corps of artificers in the Elector's military service, and of Count Spreti, first lieutenant in the regiment of artillery.

Though I was prevented, by ill-health, from being actually present at all these experiments, yet being at hand, and having every day, and almost every hour, regular reports of the progress that was made in them, and of everything extraordinary that happened, the experiments may be said, with great truth, to have been made under my immediate direction; and as the two gentlemen by whom I was assisted were not only every

way qualified for such an undertaking, but had been present, and had assisted me in a number of similar experiments, which I had myself made, they had acquired all that readiness and dexterity in the various manipulations which are so useful and necessary in experimental inquiries; and I think I can safely venture to say that the experiments may be depended on.

It would have afforded me great satisfaction to have been able to say that the experiments were all made by myself; and I had resolved to repeat them before I made them public, particularly as there appear to have been some very extraordinary and quite unaccountable differences in the results of those made in different seasons of the year; but having hitherto been prevented by ill-health, and by various avocations, from engaging in these laborious researches, I have thought it right not to delay any longer the publication of facts which appear to me to be both new and interesting, as their being known may perhaps excite others to engage in their farther investigation.

The principal objects I had in view in the following set of experiments were, first, to determine the expansive force of the elastic vapour generated in the combustion of gunpowder, in its various states of condensation, and to ascertain the ratio of its elasticity to its density: and secondly, to measure, by one decisive experiment, the utmost force of this fluid in its most dense state; that is to say, when the powder completely fills the space in which it is fired, and in which the generated fluid is confined. As these experiments were very numerous, and as it will be more satisfactory to be able to see all their results at one cursory view, I have brought them into the form of a general table.

In this table, which does not stand in need of any particular explanation, may be seen the results of all these investigations.

The dimensions of the barrel made use of in the experiments mentioned in this table were as follows : —

Diameter of the bore at its muzzle = 0.25 of an inch.

Joint capacities of the bore, and of its vent tube, exclusive of the space occupied by the leathern stopper = 0.08974 of a cubic inch.

Quantity of powder contained by the barrel and its vent tube when both were quite full (exclusive of the space occupied by the leathern stopper), 25.641 German apothecary's grains, = $24\frac{1}{2}$ grains Troy.

The capacities of the barrel and of its vent tube were determined by filling them with mercury, and then weighing in the air, and in water, the quantity of mercury required to fill them ; and the quantity of powder required to fill the barrel and its vent tube was determined by computation, from the known joint capacities of the barrel and its vent tube in parts of a cubic inch, and from the known specific gravity of the powder used in the experiments.

Thus the contents of the barrel and its vent tube having been found to amount to 0.08974 of a cubic inch, and it having been found that 1 cubic inch of the gunpowder in question, well shaken together, weighed just 272.68 grains Troy, this gives 24.47 grains Troy (= 25.641 grains German apothecary's weight) for the contents of the barrel and its vent tube.

The numbers expressing the charges of powder in *thousandth parts* of the joint capacities of the barrel and of its vent tube were determined from the known quantities of powder used in the different experiments, ex-

pressed in German apothecary's grains, and the relation of these quantities to the quantity required to fill the barrel and its vent tube completely.

Thus, as the barrel and its vent tube were capable of containing 25.641 apothecary's grains of powder, if we suppose this quantity to be divided into 1000 equal parts, this will give 39 of those parts for 1 grain; 78 parts for 2 grains; 390 for 10 grains, &c. For it is 25.641 to 1000, as 1 to 39, very nearly.

As this method of expressing the quantities of powder shows at the same time the relative density of the generated elastic fluid, it is the more satisfactory on that account: it will also considerably facilitate the computations necessary, in order to ascertain the ratio of the elasticity of this fluid to its density.

The elastic force of the fluid generated in the combustion of the charge of powder is measured by the weight by which it was confined, or rather by that which it was just able to move, but which it could not raise sufficiently to blow the leathern stopper quite out of the mouth of the bore of the barrel.

This weight, in all the experiments, except those which were made with very small charges of powder, was a piece of ordnance of greater or less dimensions or greater or less weight, according to the force of the charge, placed vertically upon its cascabel, upon the steel hemisphere which closed the end of the barrel; and the same piece of ordnance, by having its bore filled with a greater or smaller number of bullets, as the occasion required, was made to serve for several experiments.

The weight employed for confining the generated elastic fluid is expressed in the following table in *pounds avoirdupois*; but in order that a clearer and more perfect

idea may be formed of the real force of this elastic fluid, I have added a column in which its force, answering to each charge of powder, is expressed in *atmospheres*.

The numbers in this column were computed in the following manner. The diameter of the bore of the barrel at its muzzle being just $\frac{1}{4}$ of an inch, the area of its transverse section is 0.049088 of a superficial inch; and, assuming the mean pressure of the atmosphere upon 1 superficial inch equal to 15 lbs. avoirdupois, this will give 0.73631 of a pound avoirdupois, for that pressure upon 0.049088 of a superficial inch, or upon a surface equal to the area by which the generated elastic fluid acted on the weight employed to confine it; consequently the weight expressed in *pounds avoirdupois* which measured the force of the generated elastic fluid in any given experiment, being divided by 0.73631, will show how many times the pressure exerted by the fluid was greater than the mean pressure of the atmosphere. Thus in the experiment No. 6, where the weight which measured the elastic force of the generated fluid was = 504.8 lbs. avoirdupois, it is $\frac{504.8}{0.73631} = 685.6$ atmospheres. And so of the rest.

I have said that the diameter of the bore of the barrel made use of in the following experiments was just $\frac{1}{4}$ of an inch *at its muzzle*, and this is strictly true, as I found upon measuring it with the greatest care; but its diameter is not perfectly the same throughout its whole length, being rather narrower towards its lower end; yet the *capacity* of the barrel being known, and also *the diameter of the bore of its muzzle*, any small inequalities of the bore in any other part can in no wise affect the results of the experiments, as will be evident to those who will take the trouble to consider the matter for a mo-

ment with attention. I should not indeed have thought it necessary to mention this circumstance, had I not been afraid that some one who should calculate the joint capacities of the bore and of the vent tube from their lengths and diameters, finding their calculation not to agree with my determination of those capacities, as ascertained by filling them with mercury, might suspect me of having committed an error. The *mean* diameter of the bore of barrel, as determined from its length and its capacity, turns out to be just 0.2281 of an inch; the diameter of the vent tube being taken equal to 0.07 of an inch, and its length 1.715 inch.

TABLE I.

Experiments on the Force of Fired Gunpowder.

Number of the Experiment.	Time when the Experiment was made.	State of the Atmosphere.		The Charge of Powder.		Weight employed to confine the Elastic Fluid.		General Remarks.
		Thermometer.	Barometer.	In Apothecary's Gr.	In 1000 parts of the capacity of the Bore.	In lbs. avoirdupois.	In Atmospheres.	
1	1793. h. m. 23d Feb. 9 0	F. 31	Eng. In. 28.58	Gr.	Parts.	Lbs.		{ The generated elastic fluid was completely confined, the weight not being raised. { Ditto. { Ditto, weight not raised. { Ditto, ditto. { Weight just moved. { In these three experiments the weight was raised with a report as loud as that of a pistol. { Just raised, report much weaker. { Weight hardly moved. { Not raised. { Raised with a loud report. { Ditto, the report weaker. { Ditto, the report still weaker.
2	9 30	—	—	2	78	—	—	
3	25th 9 0	37	28.56	3	117	—	—	
4	10 15	—	—	4	156	—	—	
5	10 30	—	—	5	195	—	—	
6	11 0	—	—	6	234	—	685.60	
7	P. M. 3 0	57	28.37	1	39	14.16	—	
8	3 15	—	—	—	—	26.50	—	
9	3 30	—	—	—	—	38.90	—	
10	3 45	—	—	—	—	51.30	—	
11	4 0	—	—	—	—	57.40	77.86	
12	26th 9 0	34	28.10	2	78	163.50	—	
13	9 15	—	—	—	—	124.00	—	
14	9 30	—	—	—	—	130.50	—	
15	9 45	—	—	—	—	133.00	—	

TABLE I.—Continued.

Number of the Experiment.	Time when the Experiment was made.		State of the Atmosphere.		The Charge of Powder.		Weight employed to confine the Elastic Fluid.		General Remarks.
			Thermometer.	Barometer.	In Apothecary's Gr.	In 1000 parts of the capacity of the Bore.	In lbs. avoirdupois.	In Atmospheres.	
	1793.	h. m.	F.	Eng. In.	Gr.	Parts.	Lbs.		
16	26th Feb.	10 0	34	28.10	2	78	134.20	182.30	Weight but just moved.
17		3 0	48	28.31	3	117	186.30	—	Raised with a loud report.
18		3 15	—	—	—	—	198.70	—	Ditto, ditto.
19		3 30	—	—	—	—	204.80	—	Ditto, report weaker.
20		3 45	—	—	—	—	208.50	—	Raised, report weaker.
21		4 0	—	—	—	—	212.24	288.20	{ The weight hardly moved, { no report.
22	27th	3 0	50	28.36	4	156	269.20	—	Raised with a loud report.
23		3 15	—	—	—	—	274.13	—	Ditto, ditto.
24		3 30	—	—	—	—	277.90	—	Ditto, report less loud.
25		3 45	—	—	—	—	281.57	382.40	{ Weight hardly moved and { no report.
26	28th	9 0	34	28.32	5	195	319.68	—	Raised, loud report.
27		9 15	—	—	—	—	351.37	—	Ditto, ditto.
28		9 30	—	—	—	—	400.90	—	Ditto, ditto.
29		10 0	—	—	—	—	475.20	—	Not raised.
30		3 0	48	28.35	—	—	443.50	—	Not raised.
31		3 15	—	—	—	—	425.65	—	Not raised.
32		3 30	—	—	—	—	419.46	—	Not raised.
33		3 45	—	—	—	—	413.27	561.20	Weight but just moved.
34	1st Mar.	9 0	34	28.35	7	273	535.79	—	Raised with a loud report.
35		9 15	—	—	—	—	548.14	—	Ditto, ditto.
36		9 30	—	—	—	—	560.52	—	Ditto, ditto.
37		3 0	59	28.34	—	—	572.90	—	Ditto, ditto.
38		3 15	—	—	—	—	585.28	—	Ditto, report weaker.
39		3 30	—	—	—	—	597.66	811.70	{ Weight but just moved, { no report.
40		3 45	—	—	8	312	690.52	—	Raised, report very loud.
41		4 0	—	—	—	—	752.42	—	Ditto, ditto.
42		4 15	—	—	—	—	783.37	—	Ditto, ditto.
43	2d	9 0	50	28.32	—	—	876.22	—	Not raised.
44		9 15	—	—	—	—	845.19	—	But just raised, report weak
45		9 30	—	—	—	—	857.64	1164.8	{ Weight but just moved and { no report.
46		9 45	—	—	9	351	961.65	—	Raised with a loud report.
47		10 0	—	—	—	—	1209.4	—	Not raised.
48		10 30	—	—	—	—	1142.3	1551.3	Weight just moved, no report.
49		3 0	52	28.33	10	390	1456.8	—	Not raised.
50		3 30	—	—	—	—	1329.9	—	Raised, loud report.
51	5th	9 0	32	28.20	—	—	1387.5	1884.3	{ Weight but just moved and { no report.
52		9 15	—	—	11	429	1708.2	—	Not raised.

TABLE I. — *Continued.*

Number of the Experiment.	Time when the Experiment was made.		State of the Atmosphere.		The Charge of Powder.		Weight employed to confine the Elastic Fluid.		General Remarks.
			Thermometer.	Barometer.	In Apothecary's Gr.	In 1000 parts of the capacity of the Bore.	In lbs. avoirdupois.	In Atmospheres.	
	1793.	h. m.	F.	Eng. In.	Gr.	Parts.	Lbs.		
53	5th Mar.	9 45	32	28.20	11	429	1646.2	1884.3	Not raised.
54		10 15	—	—	—	—	1615.2	—	Raised with a weak report.
55		10 45	—	—	—	—	1634.0	2219.0	{ Weight but just moved and no report.
56	6th	9 0	36	28.34	1	468	1943.3	—	Not raised.
57		9 30	—	—	—	—	1932.2	—	Not raised.
58		10 30	—	—	—	—	1907.4	—	Weight not raised.
59		11 0	—	—	—	—	1878.4	—	Raised with a loud report.
60		11 30	—	—	—	—	1895.1	2573.7	{ Weight but just moved and no report.
61		3 0	42	28.30	13	507	2142.7	—	Raised with a loud report.
62		3 15	—	—	—	—	2204.6	—	Ditto, ditto.
63		3 30	—	—	—	—	2266.5	—	Raised with a loud report.
64		3 45	—	—	—	—	2390.3	—	Raised, report weaker.
65		4 0	—	—	—	—	2422.0	3288.3	Weight just moved, no report.
66	9th	9 0	43	28.31	14	546	3213.0	—	Not raised.
67		9 30	—	—	—	—	3093.0	—	Not raised.
68		10 0	—	—	—	—	2968.0	—	Not raised.
69		10 30	—	—	—	—	2846.0	—	Raised with a loud report.
70		10 45	—	—	—	—	2908.0	—	Raised, report weaker.
71		11 0	—	—	—	—	2939.0	—	Ditto, report still weaker.
72		11 15	—	—	—	—	2951.0	4008.0	{ Weight but just moved, no report.
73		11 30	—	—	15	585	3750.0	—	Not raised.
74		11 45	—	—	—	—	3508.0	—	Not raised.
75		12 15	—	—	—	—	3477.0	4722.5	{ Weight but just moved and no report.
76	11th	9 0	43	28.30	16	624	4037.0	—	{ The weight was raised with a loud report.
77		9 15	—	—	—	—	4284.0	—	Raised, loud report.
78		9 30	—	—	—	—	4532.0	—	Ditto, ditto.
79	4th Apr.	3 0	70	28.20	—	—	5027.0	—	Ditto, ditto.
80		3 15	—	—	—	—	5138.0	—	Raised, report weaker.
81		3 30	—	—	—	—	5262.0	—	Not raised.
82		3 45	—	—	—	—	5220.0	7090.0	{ Weight just moved, but no report.
83	5th	3 0	68	28.30	17	663	8081.0	—	Not raised.
84		3 30	—	—	18	702	8081.0	10977.	{ The weight was raised with a very sharp report, louder than that of a well-loaded musket.
85		4 0	—	—	—	—	8700.0	—	{ The vent tube of the barrel was burst, the explosion be- ing attended with a very loud report.

The barrel being rendered unfit for further service by the bursting of its vent tube, an end was put to this set of experiments.

In order that a clear and satisfactory idea may be formed of the results of these experiments I have drawn the Fig. 11, Plate VI., in which the given densities of the generated elastic fluid, or (which amounts to the same thing) the quantities of powder used for the charge, being taken on the line A B, from A towards B, the corresponding elasticities, as found by the experiments, are represented by lines perpendicular to the line A B at the points where the measures of the densities end.

As the irregularities of the dotted line A C are owing, no doubt, merely to the errors committed in making the experiments, these irregularities being removed, by drawing the line A D in such a manner as to balance the errors of the experiments, this line A D, which must necessarily be regular, will, by bare inspection, give us a considerable degree of insight into the nature of the equation which must be formed to express the relation of the densities to the elasticities; the discovery of which was one principal object of these experimental enquiries.

Putting the density = x and the elasticity = y , the line A D will be the locus of the equation expressing the relation of x to y ; and had Mr. Robins's supposition that the elasticity is as the density been true, x would have been found to be to y in a constant (simple) ratio, — A D would have been a straight line, — and A E would have been the position of this line, had Mr. Robins's determination of the force of fired gunpowder been accurate.

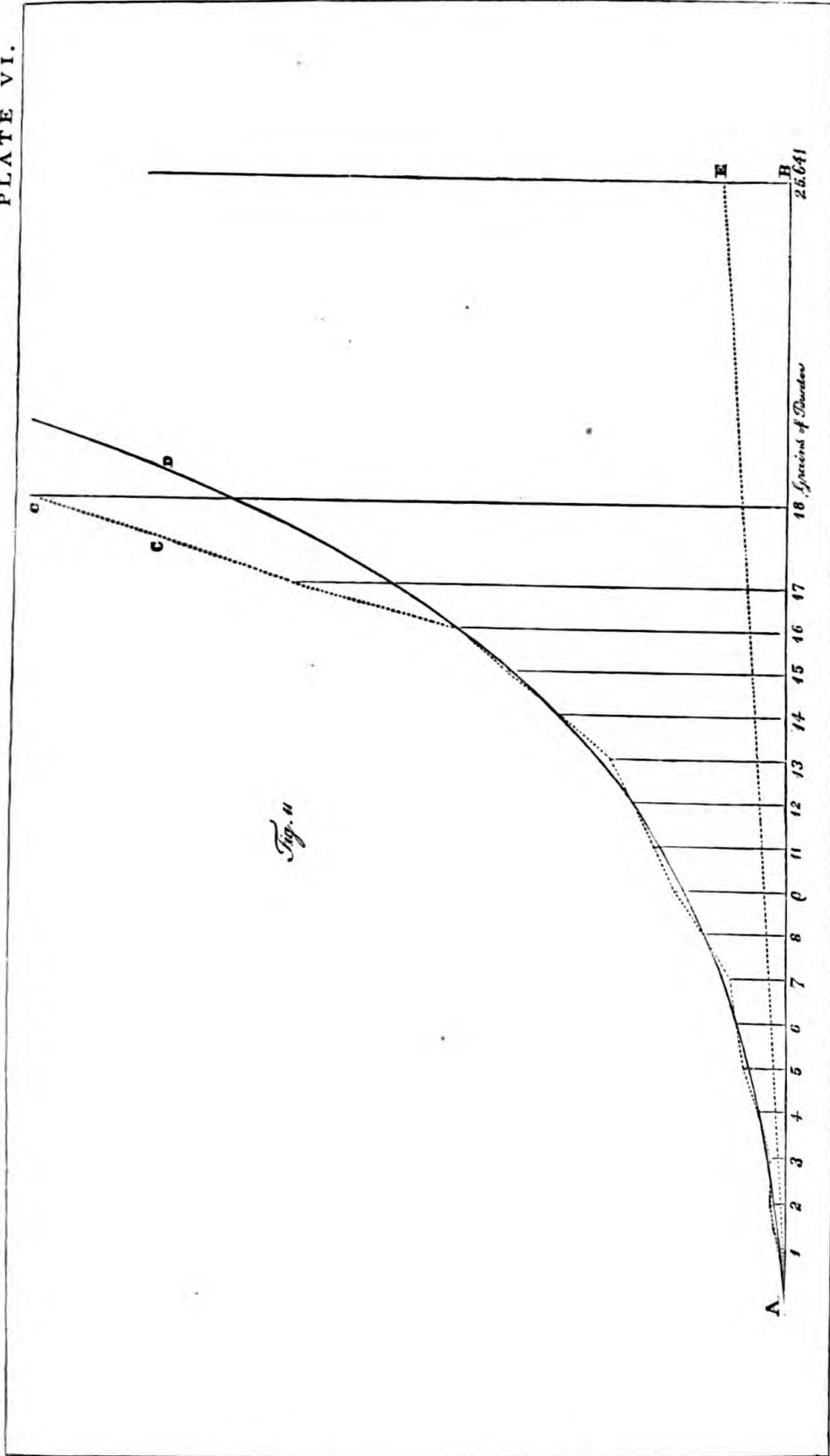

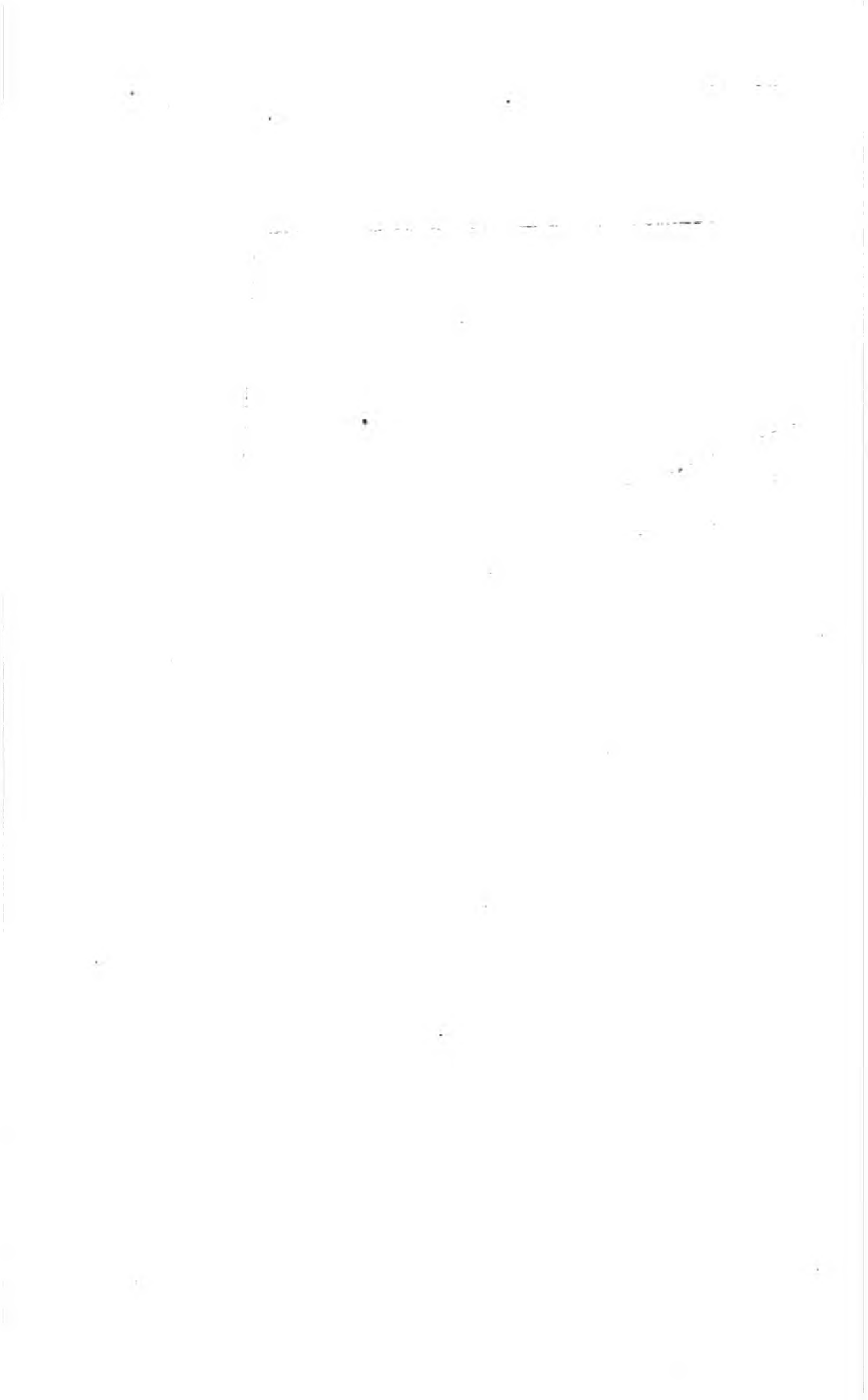

But A D is a curve, and this shows that the ratio of x to y is variable; and moreover it is a curve *convex towards the line A B*, on which x is taken, and this circumstance proves that the ratio of y to x is continually increasing.

Though these experiments all tend to show that the ratio of y to x increases as x is increased, yet when we consider the subject with attention, we shall, I think, find reason to conclude that the exponent of that ratio can never be less than *unity*; and farther, that it must of necessity have *that value precisely*, when, the density being taken infinitely small, or $= 0$, x and y vanish together.

Supposing this to be the case, namely, that the exponent of the ultimate ratio of y to x is $= 1$, let the densities or successive values of x be expressed by a series of natural numbers,

$$0, 1, 2, 3, 4, \&c. \text{ to } 1000,$$

the last term $= 1000$ answering to the greatest density; or when the powder completely fills the space in which it is confined; then, by putting $z =$ the variable part of the exponent of the ratio of y to x ,

To each of the successive values of

$$x = 0, 1, 2, 3, 4, \&c.$$

The corresponding value of y will be accurately expressed by the equations

$$0^{1+z}, 1^{1+z}, 2^{1+z}, 3^{1+z}, 4^{1+z}, \&c.$$

For as the variable part (z) of this exponent may be taken of *any dimensions*, it may be so taken at each given term of the series (or for each particular value of x), that the equation $x^{1+z} = y$ may always correspond with the result of the experiments; and when this

is done, the value of z , and the law of its increase as x increases, will be known ; and this will show the relation of x to y , or of the elasticities of the generated fluid to their corresponding densities, in a clear and satisfactory manner.

Without increasing the length of this paper still more (it being perhaps already too voluminous), by giving an account in detail of all the various computations I made, in order, from the results of the experiments in the foregoing table, to ascertain the real value of z , and the rate at which it increases as x is increased, I shall content myself with merely giving the general results of these investigations, and referring for farther information to the following Table II., where the agreement of the law founded on them, with the results of the foregoing experiments, may be seen.

Having, from the results of the experiments in Table I., computed the different values of z , corresponding to all the different densities, or different charges of powder, from 1 grain, or 39 *thousandth parts*, to 18 grains, or 702 *thousandth parts* of the capacity of the barrel, I found, that while the density of the elastic fluid = x , expressed in *thousandth parts*, is increased from 0 to 1000 (or till the powder completely fills the space in which it is confined), the variable part z of the exponent of x , ($1 + z$), is increased from 0 to $\frac{4}{10}$. And though some of the experiments, and particularly those which were made with large charges of powder, seemed to indicate that while x is increased with an equable or uniform motion, z increases with a motion continually accelerated ; *yet*, as the results of by far the greatest number of the other experiments showed the velocity of the increase of z to be *equable*, this circumstance, added to some other reasons,

drawn from the nature of the subject, have induced me to assume the ratio of the increase of z to the increase of x as constant.

But if, while x increases with an equable velocity from 0 to 1000, z is increased with an *equable velocity* from 0 to $\frac{4}{10}$, then it is everywhere z to x as $\frac{4}{10}$ to 1000; or $1000 z = \frac{4x}{10}$, and consequently $z = \frac{4x}{10000}$; and when x is = 1, it is $z = \frac{4}{10000} = 0.0004$; and when x is greater or less than 1, it is $z = 0.0004 x$; and z being expunged, the general equation expressing the relation of x to y becomes $x^{1+0.0004x} = y$; and this is the equation which was made use of in computing the values of y , expressed in the following Table.

In order that the elasticities might be expressed in atmospheres, the values of y , as determined by this equation, were multiplied by 1.841.

If it be required to express the elasticity in *pounds avoirdupois*, then the value of y , as determined by the foregoing equation, being multiplied by 27.615, will show how many pounds avoirdupois, pressing upon a superficial inch, will be equal to the pressure exerted by the elastic fluid in the case in question.

TABLE II.

General Results of the Experiments in Table I. on the Force of Fired Gunpowder.

The Charge of Powder.		Value of the Exponent $1+0.0004x$.	Computed Elasticity of the Generated Fluid, or value of y according to the Theorem, $x^1 + 0.0004x = y$.		Actual Elasticity as shewn by the Experiments.	Difference of the Computed and the Actual Elasticities.	
In Grains.	In Equal Parts.		In Equal Parts.	In Atmospheres.		In Atmospheres.	In Atmospheres.
1.	39	1.0156	41.294	76.822	77.86	+	1.838
2.	78	1.0312	89.357	164.506	182.30	+	17.794
3.	117	1.0468	146.210	269.173	228.20	-	40.973
4.	156	1.0624	213.784	393.577	382.40	-	11.177
5.	195	1.0780	294.209	541.640	561.20	+	19.560
6.	234	1.0936	389.919	717.841	685.60	-	32.241
7.	273	1.1092	503.723	927.353	811.70	-	115.653
8.	312	1.1248	638.889	1176.190	1164.80	-	12.390
9.	351	1.1404	799.223	1471.370	1551.30	+	79.930
10.	390	1.1560	989.169	1821.060	1884.30	+	63.240
11.	429	1.1716	1213.910	2234.810	2219.00	-	15.810
12.	468	1.1872	1479.500	2723.770	2573.70	-	150.070
13.	507	1.2028	1793.000	3300.910	3283.30	-	17.610
14.	546	1.2184	2162.690	3980.520	4008.00	+	27.480
15.	585	1.2340	2598.180	4783.260	4722.50	-	60.760
16.	624	1.2496	3110.730	5726.830	7090.00	+	1363.170
17.	663	1.2652	3713.460	6836.460			
18.	702	1.2808	4421.690	8140.340	10977.00	+	2836.660
19.	741	1.2964	5253.300	9671.330			
20.	780	1.3120	6229.140	11467.800			
25.641	1000	1.4000	15848.900	29177.900			

The agreement of the elasticities computed from the theorem $x^1 + 0.0004x = y$, with the actual elasticities as they were measured in the experiments, may be seen in the foregoing table; but this agreement may be seen in a much more striking manner by a bare inspection of the figure 11, Plate VI.; for the line A D in this figure, having been drawn from the computed elasticities, its general coincidence with the line A C shews how nearly the computed and the actual elasticities approach each other. And when the irregularities of the line A C (which, as

has already been observed, must be attributed to the unavoidable errors of the experiments) are corrected, these two curves will be found to coincide with much precision, throughout a considerable part of the range of the experiments; but towards the end of the set of experiments, when the charges of powder were considerably increased, the elasticities seem to have increased faster than, according to the assumed law, they ought to have done.

From this circumstance, and from the immense force the charge must have exerted in the experiment when the barrel was burst, I was led to suspect that the elastic force of the fluid generated in the combustion of gunpowder, when its density is great, is still much greater than these experiments seem to indicate; and a farther investigation of the subject served to confirm me in this opinion.

It has been shewn that the force exerted by the charge in the experiment in which the barrel was burst could not have been less than the pressure of 54,752 atmospheres; but the greatest force of the generated elastic fluid, when, the powder filling the space in which it is confined, its density is = 1000, on computing its elasticity by the theorem $x^{1+0.0004x} = y$, turns out to be only equal to 29,178 atmospheres.

In this computation the mean of the results of all the experiments in the foregoing set is taken as a standard to ascertain the value, expressed in atmospheres, of y , and it is $y \times 1.841 = 29,178$.

But if, instead of taking the mean of the whole set of experiments as a standard, we select that experiment in which the force exerted by the powder appears to have been the greatest, yet, in this case, even the initial force

of fired gunpowder computed by the above rule would be much too small.

In the experiment No. 84, when the charge consisted of 18 grains of powder, and the density, or value of x was 702, a weight equal to the pressure of 10,977 atmospheres was raised. Here the value of y ($= x^{1+0.0004x}$) is found to be $(702^{1.2808}) = 4421.7$; and to express this value of y in atmospheres, and at the same time to accommodate it to the actual result of the experiment, it must be multiplied by 2.4826; for it is 4421.7 (the value of y expressed in equal parts) to 10,977 (its value in atmospheres, as shewn by the experiment), as 1 to 2.4826, and consequently $4421.7 \times 2.4826 = 10,977$.

If now the value of y be computed on the same principles, when x is put $= 1000$, it will turn out to be $y = 1000^{1.04} = 15,849$; and this number expressed in atmospheres, by multiplying it by 2.4826, gives the value of $y = 39,346$ atmospheres.

This, however, falls still far short of 54,752 atmospheres, the force the powder was actually found to exert when the charge filled the space in which it was confined. But in the 84th experiment, when 18 grains of powder were used, as the weight (8081 lbs. avoirdupois) was raised with *a very loud report*, it is more than probable that the force of the generated elastic fluid was in fact considerably greater than that at which it was estimated, namely, greater than the pressure of 10,977 atmospheres.

But, without wasting time in fruitless endeavours to reconcile anomalous experiments, which, probably, never can be made to agree, I shall hasten to give an account of another set of experiments; the results of which, it must be confessed, were still more various, extraordinary, and inexplicable.

The machinery having been repaired and put in order, the experiments were recommenced in July, 1793, the weather at that time being very hot.

The principal part of the apparatus, *the barrel*, had undergone a trifling alteration: upon refitting and cleaning it, the diameter of its bore at the muzzle was found to be a little increased, so that a weight equal to 8081 lbs. avoirdupois, instead of being equal to 10,977 atmospheres (as was the case in the former experiments), was now just equal to the pressure of 9431 atmospheres.

Though I was not at Munich when this last set of experiments was made, they, however, were undertaken at my request, and under my direction, and I have no reason to doubt of their having been executed with all possible care. They were all made by the same persons who were employed in making the first set; and as these experimenters may be supposed to have grown expert in practice, and as they could not possibly have had any interest in deceiving me, I cannot suspect the accuracy of their reports.

TABLE III.

Experiments on the Force of Fired Gunpowder.

Number of the Experiment.	Time when the Experiment was made.		State of the Atmosphere.		The Charge of Powder.		Weight employed to confine the Elastic Fluid.		General Remarks.
			Thermometer.	Barometer.	In Apothecary's Gr.	In 1000 parts of the capacity of the Bore.	In lbs. avoirdupois.	In Atmospheres.	
86	1773.	h. m.	F.	Eng. In.	Gr.	Parts.	Lbs.		
86	1st July	4 0	88	28.37	17	663	8081	9431	{ The weight was raised with an astonishing loud report.
87		4 30	—	—	—	—	—	—	{ In these three experiments the weight was raised with a very loud report.
88		4 45	—	—	16	624	—	—	
89		5 0	—	—	15	585	—	—	
90		5 30	—	—	12	468	—	—	Weight not raised.
91		6 0	—	—	13	507	—	9431	{ Weight but just raised, report very weak.
92	2d	9 0	71	28.38	—	—	—	—	Raised, loud report.
93		9 30	—	—	12	468	—	—	Raised, feeble report.
94		10 0	—	—	—	—	—	9431	Raised, report very feeble.
95		10 30	80	—	11 $\frac{7}{8}$	—	—	—	<i>Just moved</i> , no report.
96	3d	10 0	70	28.55	12	468	—	—	Not raised.
97		10 30	—	—	13	507	—	—	Not raised.
98		11 0	75	—	14	546	—	9431	Just raised, feeble report.
99	4th	9 0	70	28.56	14	546	—	—	Not raised.
100		9 30	—	—	—	—	—	—	Not raised.
101		10 0	72	—	15	585	—	—	{ The weight was raised, the report not very loud.
102		10 30	—	—	15 $\frac{1}{2}$	—	—	—	Nearly as above.
103	8th	9 0	74	28.42	—	—	—	—	{ Raised, and with an uncommonly loud report.
104		9 30	—	—	13	507	—	—	Raised, report very loud.
105		10 45	85	—	12	468	—	9431	{ But just raised, the report very feeble.
106	17th	9 0	75	28.40	—	—	—	—	Nearly as above.
107		9 45	—	—	—	—	—	—	Ditto.
108		10 30	—	—	11 $\frac{1}{4}$	—	—	—	<i>Just moved</i> , no report.
109		11 0	—	—	—	—	—	—	The same as above.

It appears, from the foregoing table, that, in the afternoon of the 1st of July, the weight (which was a heavy brass cannon, a 24 pounder, weighing 8081 lbs. avoirdupois) was not raised by 12 grains of powder, but that 13 grains raised it with an audible though weak report. That, the next morning, July 2d, at 10 o'clock, it was

raised twice by charges of 12 grains. That, in the morning of the 3d of July, it was not raised by 12 grains nor by 13 grains; but that 14 grains just raised it. That, in the afternoon of the same day, two experiments were made with 14 grains of powder, in neither of which the weight was raised; but that in another experiment, in which 15 grains of powder were used, it was raised with a moderate report. That, in the morning of the 8th of July, in two experiments, one with $15\frac{1}{2}$ grains, and the other with 13 grains of powder, the weight was raised with a *loud report*; and in an experiment with 12 grains, it was raised with a *feeble report*. And lastly, that in two successive experiments, made in the morning of the 17th of July, the weight was raised by charges of 12 grains.

Hence it appears that, under circumstances the most favourable to the development of the force of gunpowder, a charge ($= 12$ grains) filling $\frac{4.68}{1000}$ of the cavity in which it is confined, on being fired, exerts a force against the sides of the containing vessel, equal to the pressure of 9431 atmospheres; which pressure amounts to 141,465 lbs. avoirdupois on each superficial inch.

Mr. Robins makes the initial, or greatest force of the fluid generated in the combustion of gunpowder (namely, when the charge completely fills the space in which it is confined) to be only equal to the pressure of 1000 atmospheres. It appears, however, from the result of these experiments, that even admitting the elasticities to be as the densities, as Mr. Robins supposes them to be, the initial force of this generated elastic fluid must be at least twenty times greater than Mr. Robins determined it; — for $\frac{4.68}{1000}$, the density of the elastic fluid in the experiments in question, is to 1, its density when the powder

quite fills the space in which it is confined, as 9431 atmospheres, the measure of its elastic force in the experiments in question, to 20,108 atmospheres; which, according to Mr. Robins's theory respecting the ratio of the elasticities to the densities, would be the measure of its initial force.

But all my experiments tend uniformly to prove, that the elasticities increase *faster* than in the simple ratio of the corresponding densities; consequently, the initial force of the generated elastic fluid *must necessarily* be greater than the pressure of 20,108 atmospheres.

In one of my experiments, which I have often had occasion to mention, the force actually exerted by the fluid must have been at least equal to the pressure of 54,752 atmospheres. The other experiments ought, no doubt, to shew, at least, that it is *possible* that such an enormous force may have been exerted by the charge made use of; and this, I think, they actually indicate.

In the first set of experiments, which were made when the weather was cold, though the results of them uniformly shewed the force of the powder to be much less than it appeared to be in all the subsequent experiments, made with greater charges and in warm weather, yet they all shew that the ratio of the elasticity of the generated fluid to its density is very different from that which Mr. Robins's theory supposes; and that this ratio increases as the density of the fluid is increased.

Supposing (what on many accounts seems to be extremely probable) that this ratio increases uniformly, or with an equable celerity, while the density is uniformly augmented; and supposing farther, that the velocity and limit of its increase have been rightly determined from the result of the set of experiments, Table I., which

were made with that view; then, from the result of the experiments of which we have just been giving an account (in which 12 grains of powder exerted a force equal to 9431 atmospheres), taking these experiments as a standard, we can, with the help of the theorem ($x^{1+0.0004x} = y$) deduced from the former set of experiments, compute the initial force of fired gunpowder, thus:—

The density of the elastic fluid, when 12 grains of powder are used for the charge, being = 468, it is $468^{1.1872} = y = 1479.5$; and in order that this value of y may correspond with the result of the experiment, and be expressed in atmospheres, it must be multiplied by a certain coefficient, which will be found by dividing the value of y expressed in atmospheres, as shewn by the experiment, by the number here found indicating its value, as determined by computation.

It is therefore $\frac{9431}{1479.5} = 6.3744$ for the value of this coefficient; and this multiplied into the number 1479.5 gives 9431 for the value of y in atmospheres.

Again, the density being supposed = 1000 (or that the charge of powder completely fills the cavity in which it is confined), in that case it will be $1000^{1+0.4} = y = 15,849$; and this number being turned into atmospheres by being multiplied by the coefficient above found (= 6.3744), gives 101,021 atmospheres for the measure of the *initial force* of the elastic fluid generated in the combustion of gunpowder.

Enormous as this force appears, I do not think it overrated; for nothing much short of such an inconceivable force can, in my opinion, ever explain in a satisfactory manner the bursting of the barrel so often mentioned; and to this we may add, that, as in 7 different

experiments, all made with charges of 12 grains of powder, there were no less than 5 in which the weight was *raised with a report*; and as the same weight was *moved* in 3 different experiments in which the charge consisted of less than 12 grains, there does not appear to be any reason whatever for doubt with regard to the principal fact on which the above computation is founded.

There is an objection, however, that may be made to these decisions respecting the force of gunpowder, which on the first view appears to be of considerable importance; but on a more careful examination it will be found to have no weight.

If the force of fired gunpowder is so very great, how does it happen that fire-arms, and artillery of all kinds, which certainly are not calculated to withstand so enormous a force, are not always burst when they are used? I might answer this question by another, by asking how it happened that the barrel used in my experiments, and which was more than 10 times stronger in proportion to the size of its bore than ever a piece of ordnance was formed, could be burst by the force of gunpowder, if its force is not in fact much greater than it has ever been supposed to be? But it is not necessary to have recourse to such a shift to get out of this difficulty; there is nothing more to do than to shew, which may easily be done, that the combustion of gunpowder is less rapid than it has hitherto been supposed to be, and the objection in question falls to the ground.

Mr. Robins's theory supposes that all the powder of which a charge consists is not only set on fire, but that it is actually *consumed* and "*converted into an elastic fluid before the bullet is sensibly moved from its place.*" I have already, in the former part of this paper, offered several

reasons which appeared to me to prove that, though the *inflammation* of gunpowder is very rapid, yet the progress of the combustion is by no means so *instantaneous* as has been imagined. I shall now give an account of some experiments which put that matter out of all doubt.

It is a fact well known, that on the discharge of fire-arms of all kinds, cannon and mortars, as well as muskets, there is always a considerable quantity of unconsumed grains of gunpowder blown out of them; and, what is very remarkable, and as it leads directly to a discovery of the cause of this effect is highly deserving of consideration, these unconsumed grains are not merely blown out of the *muzzles* of fire-arms; they come out also by their vents or touch-holes, *where the fire enters to inflame the charge*; as many persons who have had the misfortune to stand with their faces near the touch-hole of a musket, when it has been discharged, have found to their cost.

Now it appears to me to be extremely improbable, if not absolutely impossible, that a grain of gunpowder, actually in the chamber of the piece, and completely surrounded by flame, should, by the action of that very flame, be blown out of it, without being at the same time set on fire. But if these grains of powder are *actually on fire* when they come out of the piece, and are afterwards found at a distance from it *unconsumed*, this is, in my opinion, a most decisive proof, not only that the combustion of gunpowder is by no means so rapid as it has generally been thought to be, but also (what will doubtless appear quite incredible), that if a grain of gunpowder, actually on fire, and burning with the utmost violence over the whole extent of its surface, be projected with *a very great velocity* into a cold atmosphere, the fire will be extin-

guished, and the remains of the grain will fall to the ground, unchanged, and as inflammable as before.

This extraordinary fact was ascertained beyond all possibility of doubt by the following experiments. Having procured from a powder-mill in the neighbourhood of the city of Munich a quantity of gunpowder, all of the same mass, but formed into grains of very different sizes, some as small as the grains of the finest Battel powder, and the largest of them nearly as big as large pease, I placed a number of vertical screens of very thin paper, one behind another, at the distance of 12 inches from each other; and loading a common musket repeatedly with this powder, sometimes without, and sometimes with a wad, I fired it against the foremost screen and observed the quantity and effects of the unconsumed grains of powder which impinged against it.

The screens were so contrived, by means of double frames united by hinges, that the paper could be changed with very little trouble, and it was actually changed after every experiment.

The distance from the muzzle of the gun to the first screen was not always the same; in some of the experiments it was only 8 feet, in others it was 10, and in some 12 feet.

The charge of powder was varied in a great number of different ways, but the most interesting experiments were made with one single large grain of powder, propelled sometimes by smaller and sometimes by larger charges of very fine-grained powder.

These large grains never failed to reach the screen; and though they sometimes appeared to have been broken into several pieces, by the force of the explosion, yet they frequently reached the first screen entire; and

sometimes passed through all the screens (five in number) without being broken.

When they were propelled by large charges, and consequently with great velocity, they were seldom on fire when they arrived at the first screen, which was evident, not only from their not setting fire to the paper (which they sometimes did), but also from their being found sticking in a soft board, against which they struck, after having passed through all the five screens; or leaving visible marks of their having impinged against it, and being broken to pieces and dispersed by the blow. These pieces were often found lying on the ground; and from their forms and dimensions, as well as from other appearances, it was often quite evident that the little globe of powder had been on fire, and that its diameter had been diminished by the combustion, before the fire was put out, on the globe being projected into the cold atmosphere. The holes made in the screen by the little globe in its passage through them seemed also to indicate that its diameter had been diminished.

That these globes, or large grains of powder, were always set on fire by the combustion of the charge can hardly be doubted. This certainly happened in many of the experiments, for they arrived at the screens on fire, and set fire to the paper; and in the experiments in which they were projected with small velocities, they were often seen to pass through the air on fire; and when this was the case, no vestige of them was to be found.

They sometimes passed, on fire, through several of the foremost screens without setting them on fire, and set fire to one or more of the hindmost, and then went on and impinged against the board, which was placed at the distance of 12 inches behind the last screen.

It is hardly necessary for me to observe, that all these experiments prove that the combustion of gunpowder is very far from being so instantaneous as has generally been imagined. I will just mention one experiment more, in which this was shewn in a manner still more striking, and not less conclusive. A small piece of red-hot iron being dropped down into the chamber of a common horse-pistol, and the pistol being elevated to an angle of about 45 degrees, upon dropping down into its barrel one of the small globes of powder (of the size of a pea), it took fire, and was projected into the atmosphere by the elastic fluid generated in its own combustion, leaving a very beautiful train of light behind it, and disappearing all at once, like a falling star.

This amusing experiment was repeated very often, and with globes of different sizes. When very small ones were used singly, they were commonly consumed entirely before they came out of the barrel of the pistol; but when several of them were used together, some, if not all of them, were commonly projected into the atmosphere on fire.

I shall conclude this paper by some observations on the practical uses and improvements that may probably be derived from these discoveries, respecting the great expansive force of the fluid generated in the combustion of gunpowder.

As the *slowness* of the combustion of gunpowder is undoubtedly the cause which has prevented its enormous and almost incredible force from being discovered, so it is evident, that the readiest way to increase its effects is to contrive matters so as to accelerate its inflammation and combustion. This may be done in various ways, but the most simple and most effectual manner of doing

it would, in my opinion, be to set fire to the charge of powder by shooting (through a small opening) the flame of a smaller charge into the midst of it.

I contrived an instrument on this principle for firing cannon, several years ago, and it was found on repeated trials to be useful, — convenient in practice, — and not liable to accidents. It likewise supersedes the necessity of using priming, — vent tubes, — port-fires, — and matches; and on that account I imagined it might be of use in the British navy. Whether it has been found to be so or not I have not heard.

Another infallible method of increasing very considerably the effect of gunpowder in fire-arms of all sorts and dimensions would be to cause the bullet to fit the bore exactly, or without windage, *in that part of the bore, at least, where the bullet rests on the charge*; for when the bullet does not completely close the opening of the chamber, not only much of the elastic fluid generated in the first moment of the combustion of the charge escapes by the sides of the bullet, but, what is of still greater importance, a considerable part of the unconsumed powder is blown out of the chamber along with it, in a state of actual combustion, and, getting before the bullet, continues to burn on as it passes through the whole length of the bore, by which the motion of the bullet is much impeded.

The loss of force which arises from this cause is, in some cases, almost incredible; and it is by no means difficult to contrive matters so as to render it very apparent, and also to prevent it.

If a common horse-pistol be fired with a loose ball, and so small a charge of powder that the ball shall not be able to penetrate a deal board so deep as to stick in

it, when fired against it from the distance of six feet, — the same ball, discharged from the same pistol, with the same charge of powder, may be made to pass quite through one deal board, and bury itself in a second placed behind it, *merely by preventing the loss of force which arises from what is called windage*; as I have found more than once by actual experiment.

I have, in my possession, a musket, from which, with a common musket charge of powder, I fire two bullets at once with the same velocity that a single bullet is discharged from a musket on the common construction, with the same quantity of powder. And, what renders the experiment still more striking, — the diameter of the bore of my musket is exactly the same as that of a common musket, except only in that part of it where it joins the chamber, in which part it is just so much contracted that the bullet which is next to the powder may stick fast in it. I ought to add that, though the bullets are of the common size, and are consequently considerably less in diameter than the bore, means are used which *effectually* prevent the loss of force by windage; and to this last circumstance it is doubtless owing, in a great measure, that the charge appears to exert so great a force in propelling the bullets.

That the conical form of the lower part of the bore, where it unites with the chamber, has a considerable share in producing this extraordinary effect, is however very certain, as I have found by experiments made with a view merely to ascertain that fact.

I will finish this paper by a computation, which will shew that the force of the elastic fluid generated in the combustion of gunpowder, enormous as it is, may be satisfactorily accounted for upon the supposition that its

force depends *solely* on the elasticity of watery vapour, or steam.

It has been shewn by a variety of experiments made in England, and in other countries, and lately by a well-conducted set of experiments made in France by M. de Betancour, and published in Paris under the auspices of the Royal Academy of Sciences, in the year 1790, that the elasticity of steam is doubled by every addition of temperature equal to 30 degrees of Fahrenheit's thermometer.

Supposing now a cavity of any dimensions (equal in capacity to 1 cubic inch, for instance) to be filled with gunpowder, and that on the combustion of the powder, and in consequence of it, this space is filled with steam (and I shall presently shew that the water, existing in the powder *as water*, is abundantly sufficient for generating this steam), if we know the heat communicated to this steam in the combustion of powder, we can compute the elasticity it requires by being so heated.

Now it is certain that the heat generated in the combustion of gunpowder cannot possibly be less than that of red-hot iron. It is probably much greater, but we will suppose it to be only equal to 1000 degrees of Fahrenheit's scale, or something less than iron visibly red-hot in daylight. This is about as much hotter than boiling linseed oil, as boiling linseed oil is hotter than boiling water.

As the elastic force of steam is just equal to the mean pressure of the atmosphere when its temperature is equal to that of boiling water, or to 212° of Fahrenheit's thermometer, and as its elasticity is doubled by every addition of temperature equal to 30 degrees of the same scale, with the heat of $212^{\circ} + 30^{\circ} = 242^{\circ}$ its elasticity will be equal to the pressure of 2 atmospheres; at the

temperature of $242^{\circ} + 30^{\circ} = 272^{\circ}$ it will equal 4 atmospheres;

at $272^{\circ} + 30^{\circ} = 302^{\circ}$	it will equal	8 atmospheres;
“ $302 + 30 = 332$	“ “ “	16 “
“ $332 + 30 = 362$	“ “ “	32 “
“ $362 + 30 = 392$	“ “ “	64 “
“ $392 + 30 = 422$	“ “ “	128 “
“ $422 + 30 = 452$	“ “ “	256 “
“ $452 + 30 = 482$	“ “ “	512 “
“ $482 + 30 = 512$	“ “ “	1024 “
“ $512 + 30 = 542$	“ “ “	2048 “
“ $542 + 30 = 572$	“ “ “	4096 “
“ $572 + 30 = 602$		

(or 2 degrees above the heat of boiling linseed oil), its elasticity will be equal to the pressure of 8192 atmospheres, or above *eight times* greater than the utmost force of the fluid generated in the combustion of gunpowder, according to Mr. Robins's computation. But the heat generated in the combustion of gunpowder is much greater than that of 602° of Fahrenheit's thermometer, consequently the elasticity of the steam generated from the water contained in the powder must of necessity be much greater than the pressure of 8192 atmospheres.

Following up our computations on the principles assumed, we shall find that,

at the temperature of	} the elasticity will be equal to the pressure of
$602 + 30 = 632$	
at $632 + 30 = 662$	16,384 atmospheres;
at $662 + 30 = 692$	32,768 “
and at $692 + 30 = 722$	65,536 “

the elasticity will be equal to the pressure of 131,072 atmospheres, which is 130 times greater than the elastic force assigned by Mr. Robins to the fluid generated in

the combustion of gunpowder; and about one-sixth part greater than my experiments indicated it to be.

But even here the heat is still much below that which is most undoubtedly generated in the combustion of gunpowder. The temperature which is indicated by 722° of Fahrenheit's scale (which is only 122 degrees higher than that of boiling quicksilver, or boiling linseed oil) falls short of the heat of iron which is visibly red-hot in daylight by 355 degrees; but the flame of gunpowder has been found to melt brass, when this metal, in very small particles, has been mixed with the powder; and it is well known that to melt brass a heat is required equal to that of 3807 degrees of Fahrenheit's scale; 2730 degrees above the heat of red-hot iron, or 3085 degrees higher than the temperature which gives to steam an elasticity equal to the pressure of 131,072 atmospheres.

That the elasticity of steam would actually be increased by heat in the ratio here assumed can hardly be doubted. It has absolutely been found to increase in this ratio in all the changes of temperature between the point of boiling water (I may even say of freezing water) and that of 280° of Fahrenheit's scale; and there does not appear to be any reason why the same law should not hold in higher temperatures.

A doubt might possibly arise with respect to the existence of a sufficient quantity of water in gunpowder to fill the space in which the powder is fired with steam, at the moment of the explosion; but this doubt may easily be removed.

The best gunpowder, such as was used in my experiments, is composed of 70 parts (in weight) of nitre, 18 parts of sulphur, and 16 parts of charcoal; hence 100

parts of this powder contain $67\frac{3}{10}$ parts of nitre, $17\frac{3}{10}$ parts of sulphur, and of charcoal $15\frac{4}{10}$ parts.

Mr. Kirwan has shewn, that in 100 parts of nitre there are 7 parts of water of crystallization; consequently, in 100 parts of gunpowder, as it contains $67\frac{3}{10}$ parts of nitre, there must be $4\frac{7\frac{1}{10}}{1000}$ parts of water.

Now, as 1 cubic inch of gunpowder, when the powder is well shaken together, weighs exactly as much as 1 cubic inch of water at the temperature of 55° F., namely, 253.175 grains Troy, a cubic inch of gunpowder in its driest state must contain at least $10\frac{927}{1000}$ grains of water; for it is 100 to 4.711, as 253.175 to 10.927. But besides the water of crystallization which exists in the nitre, there is always a considerable quantity of water in gunpowder, in that state in which it makes bodies *damp* or *moist*. Charcoal exposed to the air has been found to absorb nearly $\frac{1}{8}$ of its weight of water; and by experiments I have made on gunpowder, by ascertaining its loss of weight on being much dried, and its acquiring this lost weight again on being exposed to the air, I have reason to think that the power of the charcoal, which enters into the composition of gunpowder, to absorb water remains unimpaired, and that it actually retains as much water in that state as it would retain were it not mixed with the nitre and the sulphur.

As there are $15\frac{4}{10}$ parts of charcoal in 100 parts of gunpowder, in 1 cubic inch of gunpowder ($= 253.175$ grains Troy), there must be 38.989 grains of charcoal; and if we suppose $\frac{1}{8}$ of the apparent weight of this charcoal to be water, this will give 4.873 grains in weight for the water which exists in the form of *moisture* in 1 cubic inch of gunpowder.

That this estimation is not too high is evident from the following experiment. 1160 grains Troy of apparently dry gunpowder, taken from the middle of a cask, on being exposed 15 minutes in dry air, heated to the temperature of about 200° , was found to have lost 11 grains of its weight. This shews that each cubic inch of this gunpowder actually gave out $2\frac{4}{10}$ grains of water on being exposed to this heat; and there is no doubt but that at the end of the experiment it still retained much more water than it had parted with.

If now we compute the quantity of water which would be sufficient, when reduced to steam under the mean pressure of the atmosphere, to fill a space equal in capacity to 1 cubic inch, we shall find that, either that contained in the nitre which enters into the composition of 1 cubic inch of gunpowder as *water of crystallization*, or even that small quantity which exists in the powder in the state of *moisture*, will be much more than sufficient for that purpose.

Though the density of steam has not been determined with that degree of precision that could be wished, yet it is quite certain that it cannot be less than 2000 times rarer than water, when both are at the temperature of 212° . Some have supposed it to be more than 10,000 times rarer than water, and experiments have been made which seem to render this opinion not improbable; but we will take its density at the highest estimation, and suppose it to be only 2000 times rarer than water. As 1 cubic inch of water weighs 253.175 grains, the water contained in 1 cubic inch of steam at the temperature of 212° will be $\frac{1}{2000}$ part of 253.175 grains, or 0.12659 of a grain.

But we have seen that 1 cubic inch of gunpowder

contains 10.927 grains of water of crystallization, and 4.873 grains in a state of moisture. Consequently, the quantity of water of crystallization in gunpowder is 86 times greater, and the quantity which exists in it in a state of *moisture* is 38 times greater than that which would be required to form a quantity of steam sufficient to fill completely the space occupied by the powder.

Hence we may venture to conclude that the quantity of water actually existing in gunpowder is much more than sufficient to generate all the steam that would be necessary to account for the force displayed in the combustion of gunpowder (supposing that force to depend solely on the action of steam), even though no water should be generated in the combustion of the gunpowder. It is even very probable that there is more of it than is wanted, and that the force of gunpowder would be still greater, could the quantity of water it contains be diminished.

From this computation it would appear, that the difficulty is not to account for the force actually exerted by fired gunpowder, but to explain the reason why it does not exert a much greater force. But I shall leave these investigations to those who have more leisure than I now have to prosecute them.

SUPPLEMENTARY OBSERVATIONS.

ALTHOUGH there is no reason to doubt of the accuracy of M. Betancour's experiments, yet there is one important point which still remains to be ascertained, before the hypothesis I have here endeavoured to establish on the results of those experiments, respecting the force exerted by steam in combustion of gunpowder, can be admitted.

The steam, the elastic force of which was measured in M. Betancour's experiments, *remained constantly in contact with water, in a liquid state.* How far did the presence of this water, and the progressive change of a part of it to steam, as the heat was gradually increased, and the addition to the *density* of the steam which resulted therefrom, contribute to the increase of the elasticity of the steam which was observed?

This is a very important question, and the solution of it must necessarily decide the fate of our hypothesis: and after mature consideration, I am myself inclined to think that I have been precipitate in ascribing too much to the agency of steam in the force exerted by fired gunpowder. I was led into this error, if it be one, on finding the explanation of the cause of the force of gunpowder given by Mr. Robins to be quite inadequate to its effects, as shewn in my experiments. But I did not at first advert to the degree in which one of the suppositions made by Mr. Robins (namely, that respecting the heat of the generated elastic fluid) is gratuitous; nor did I then perceive how very probable it is that he has greatly underrated it.

The supposition of Mr. Robins respecting the heat

was such as enabled him to reconcile the results of *his experiments* with *his theory*; and as later discoveries have shewn his theory to be unfounded, some of his assumed principles must of necessity have been erroneous.

The most unexceptionable of the suppositions of Mr. Robins relative to the subject under consideration is that respecting the quantity of air, or *permanently elastic fluid*, that is generated from gunpowder in its combustion. It cannot, indeed, with propriety be called a supposition, for it was the result of a well-contrived experiment.

According to Mr. Robins, when any given quantity of gunpowder is fired, the quantity of permanently elastic fluid or fluids generated from it in its combustion is such that, when cooled down to the mean temperature of the atmosphere, it would — under the mean pressure of the atmosphere — fill a space 250 times greater than that which the unfired powder occupied. Consequently, if this fluid were compressed into a space no greater than that occupied by unfired powder, it would, in its endeavours to expand itself, on being so compressed, exert a force 250 times greater than the mean pressure of the atmosphere; or (to use the language, employed in the foregoing paper) its force would be equal to 250 atmospheres.

This is very far indeed from 100,000 atmospheres, — the expansive force we have assigned to fired gunpowder, — but let us see how far *the heat* generated in the combustion of gunpowder may be supposed to increase the expansive force of the elastic fluids which are generated in that process.

From the experiments of the late General Roy, it has been proved that the expansive force of common at-

Atmospherical air is doubled with an increase of heat indicated by 437 degrees of Fahrenheit's scale; and I was lately informed by that excellent chemist and natural philosopher, M. Bertholet, that he has found by repeated experiments, that the expansions with heat of all the gazes, or different kinds of permanently elastic fluids, are precisely the same, whatever may be the difference of their specific gravities, or of their chemical or other properties.

Supposing now that the permanently elastic fluids generated in the combustion of gunpowder follow the same law in their expansions with heat, we can easily determine, by computation, how much the expansive force of those fluids will be augmented by any given augmentation of heat.

If the temperature of air of the atmosphere be 60° F. when the expansive force of the permanently elastic fluid generated in the combustion of gunpowder — *being at that temperature* — is equal to 250 atmospheres; if the temperature of that fluid be raised 437 degrees, or if it become 497° of Fahrenheit's scale ($60^{\circ} + 437^{\circ} = 497^{\circ}$), — there can be no doubt whatever but its elastic force will be doubled; or that it will become 500 times greater than the mean pressure of the atmosphere.

If its temperature be raised 437 degrees higher, or if it be heated to 934° F., its elasticity will be again doubled, and will become = 1000 atmospheres, which is the initial force of the elastic fluid generated in the combustion of fired gunpowder, according to Mr. Robins.

But there are many strong reasons for supposing that the heat generated in the combustion of gunpowder is vastly higher than that indicated by 937° of Fahrenheit's scale.

If the heat be only that indicated by 3996° F. (which is many degrees below that at which either copper, silver, or gold melts), that heat will be sufficient to double the expansive force last found ($= 1000$ atmospheres) *seven times*, which will make it equal to the pressure of *one hundred and twenty-eight thousand atmospheres*; a degree of elastic force considerably more than sufficient to account for the results of all the experiments mentioned in this paper.

A SHORT ACCOUNT
OF SOME
EXPERIMENTS MADE WITH CANNON,
AND ALSO OF
SOME ATTEMPTS TO IMPROVE FIELD
ARTILLERY.

DURING my residence in Bavaria, I had an opportunity of verifying, upon a large scale, the method proposed in my first Paper on Gunpowder, for measuring the velocities of bullets by the recoil of the gun, and I had also opportunities of making several other interesting experiments connected with that subject. In the spring of the year 1791, a large building was erected for the express purpose of pursuing these investigations, in the neighbourhood of Munich, on the ground destined for the exercise of the artillery, where a most complete apparatus was put up for measuring the velocities of cannon bullets by the recoil of the gun, and also by the pendulum at the same time; and with this apparatus a great number of interesting experiments were made under my direction, and most of them in my presence. I should long ago have laid an account of them before the public had I not been induced to postpone their publication by a desire that they might make a part of a work on artillery, yet unfinished, but which I hope, at some future period, to be able to send to the press.

In this work I shall give a detailed account, illus-

trated by accurate plans (which are now ready for the engraver), of all the changes in the construction of the Bâvarian artillery, which were introduced in my attempts to improve it, during the time the military affairs of that country were under my direction. In the mean time I have thought it advisable to give, in this place, a short account of such of my experiments as are most intimately connected with the subjects of the two preceding papers; and this I shall now do in as few words as possible.

Pieces of brass ordnance, of three different calibres, viz. 3 pounders, 6 pounders, and 12 pounders, having been suspended, in an horizontal position, by long pendulous rods, or bars of iron, in the manner described in one of the foregoing papers, these guns were fired in this situation, with different charges of powder; with, and also without bullets; and sometimes with two and with three fit bullets at the same time; and the velocity of the gun in its recoil having been determined, in each experiment, by the length (measured by means of a ribband) of the chord of the ascending arc of its first vibration, from that velocity, and the known weights of the gun and of the bullet, the velocity of the bullet was computed.

The gun having been pointed against the center of a very large heavy pendulum, constructed of strong timbers, well fastened together with iron, the bullets lodged in that pendulum; and their velocities were determined, according to Mr. Robins's method, by the arcs of the vibration of the pendulum; and these two methods of ascertaining the velocities of the bullets were found to agree with great accuracy.

This pendulum, although it was made very strong,

was, however, soon destroyed by the bullets ; but it was not rendered useless till after a sufficient number of experiments had been made with it to establish, beyond all doubt, the accuracy of the proposed method of determining the velocities of cannon bullets by the recoil of the gun. As soon as this was done, the pendulum, being no longer wanted, was removed, and the bullets were fired into a mound of earth, which had been thrown up to receive them.

The general results of this course of experiments were as follows : With the same charge of powder, the velocities of *two* and *three* fit bullets, discharged at once from the cannon, were found to be greater than the velocity of a *single bullet*, impelled by the given charge, in a proportion considerably higher than that determined by Mr. Robins.

Means were employed, which prevented entirely the escape, by windage, of the elastic fluid generated from the powder in its combustion, and this added very considerably to the apparent force of the charge.

The force of the charge was always sensibly increased when the gun was discharged by firing a pistol (constructed for that use) into the vent, instead of using a priming and a common match for firing off the gun.

As I have entered upon this subject, and as it is possible that I may never find leisure to finish the work on Artillery, which, for many years, I have had in hand, I cannot resist the inclination I feel to avail myself of this opportunity to submit to the public—but more especially to professional men—some of the principal results of my experiments and meditations in the prosecution of my inquiries relative to the improvement of artillery.

Those who are engaged in these researches may, perhaps, derive some advantage from the hints, however cursory they may be, of a person who has long been in a habit of observing ; and who has had many opportunities of making interesting experiments.

When I was called to take the direction of the military affairs of the late Elector Palatine, Duke of Bavaria, the army was destitute of a well-organized train of field artillery ; and there was no Cannon Foundry in Bavaria that was in a condition to be used. The arsenal at Munich was filled with cannon, but by far the greater part of them were perfectly useless, being very ancient, and too heavy and unwieldy to be moved. There was a very good Cannon Foundry at Manheim, the capital of the Elector's dominions upon the Rhine ; but the distance between Munich and Manheim is so great that it would have cost more to have sent the Bavarian guns to Manheim to be refounded, and to have brought them back by land carriage, than was required to defray the expence of establishing a new manufactory for the construction of artillery in Bavaria.

A Foundry was accordingly established at Munich, and neither pains nor expence were spared to make it as perfect as possible ; and a most excellent machine was erected for boring cannon ; with work-shops adjoining to it for the construction of gun-carriages and ammunition waggons.

With these advantages, and with a set of good workmen at my command in all the different branches of mechanics that are concerned in the construction of artillery, it will readily be believed, by those who know how much my attention had been employed on that subject, that I did not neglect to avail myself of so

Scale of 12 Inches to the Six Rhinland Measures
or 1000 Rhinland feet are equal to 1033 English feet.

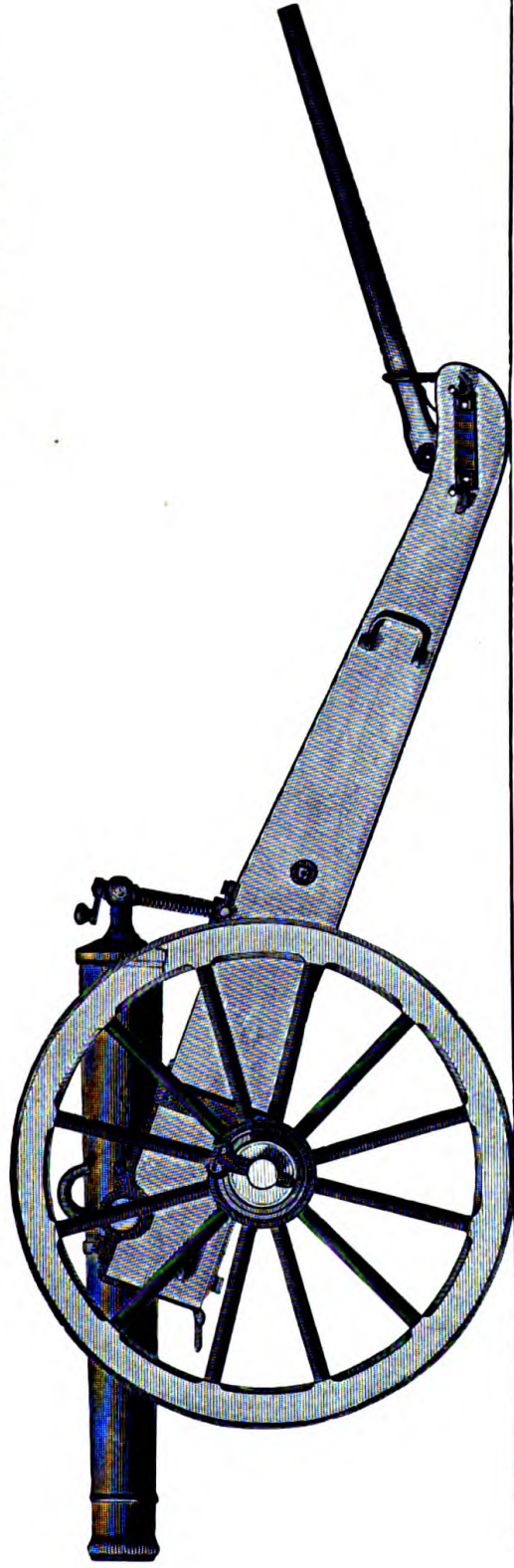

Elevation of a Bavarian Brass Six-Pounder.

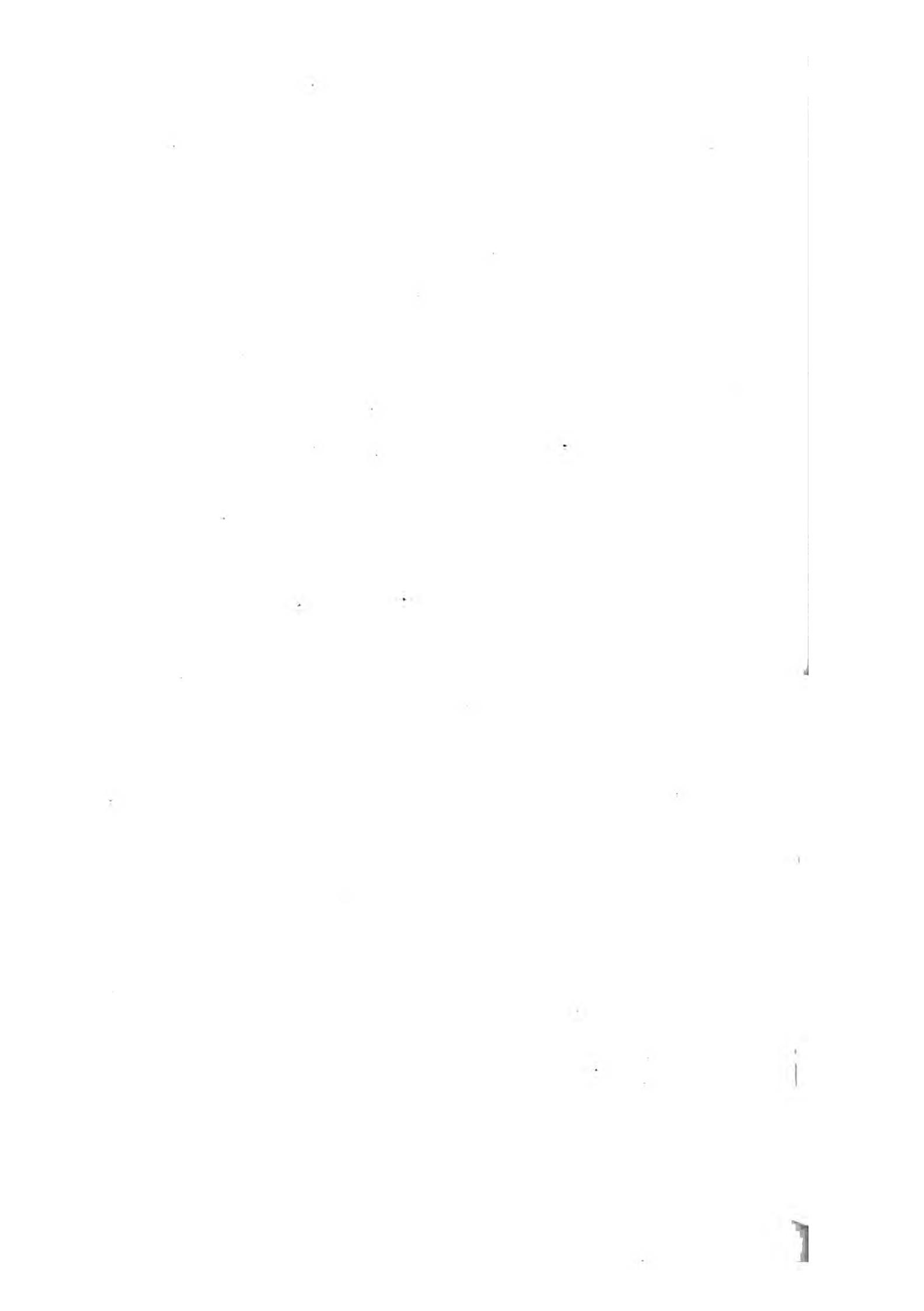

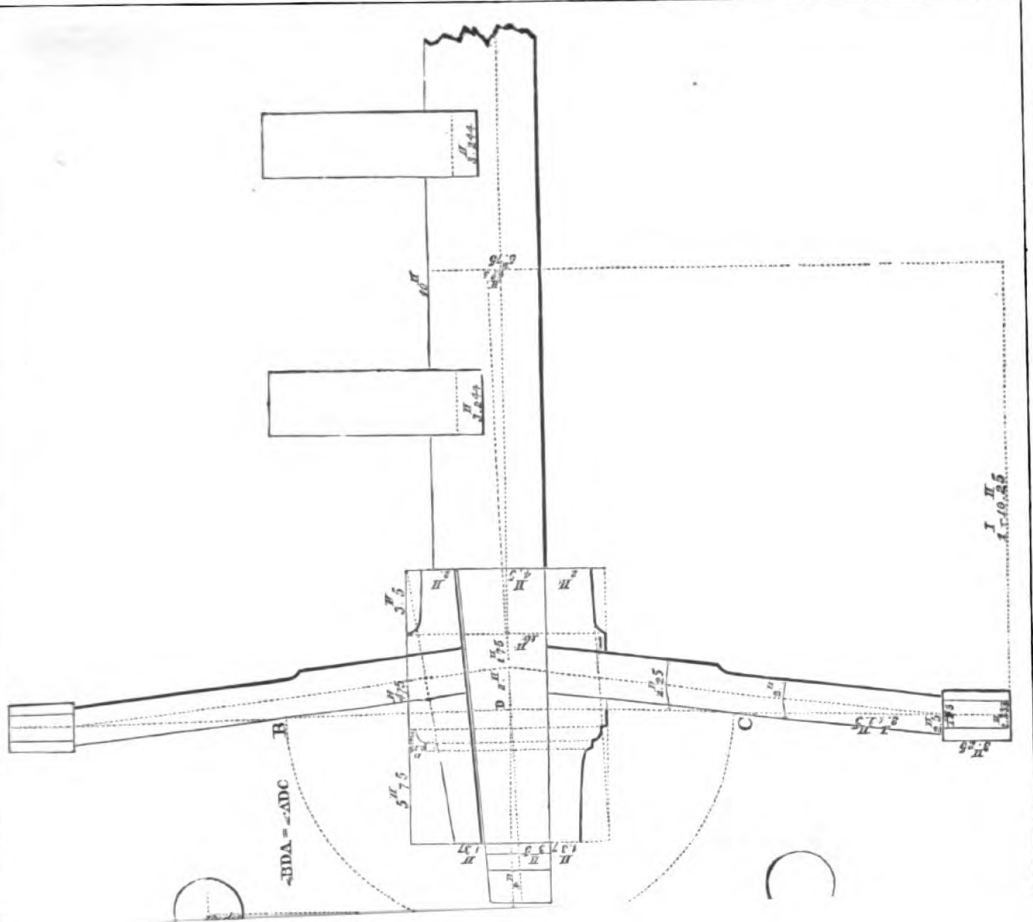

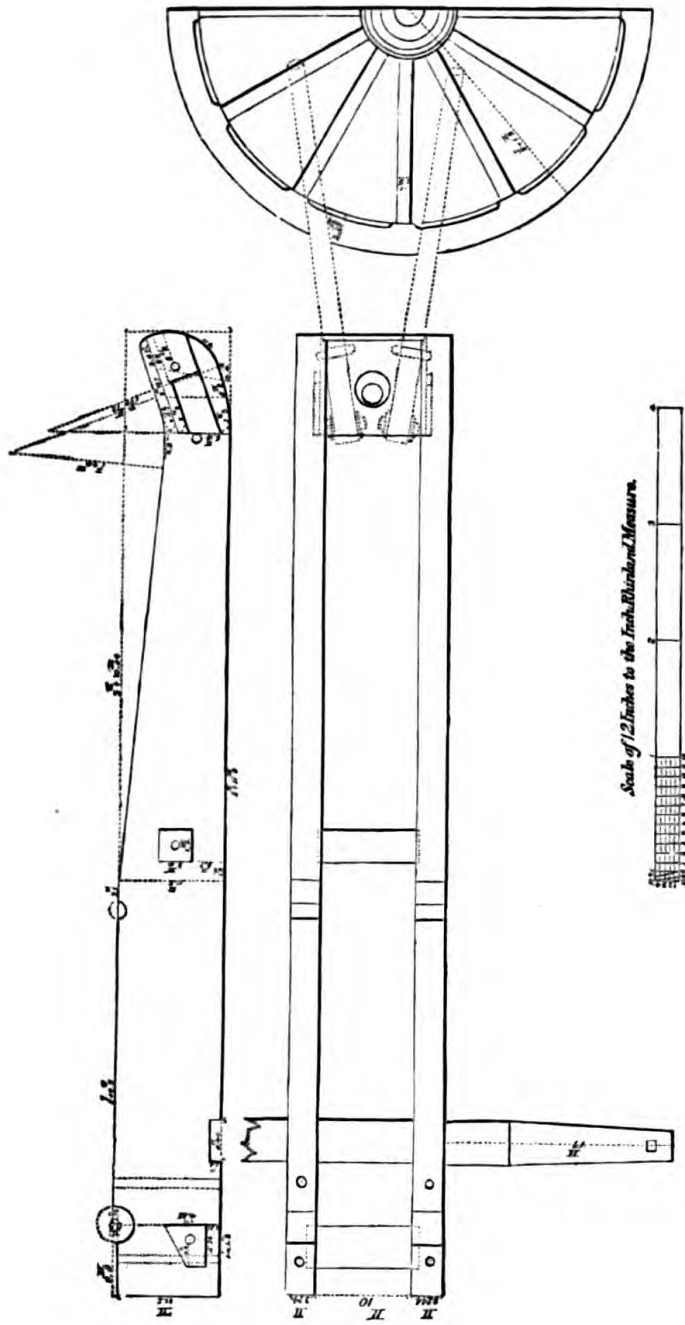



favourable an opportunity to make trial of some of the plans for the improvement of artillery which had been recommended by professional men of eminence; or that had been the result of my own experiments and meditations.

The following *Memoir*, that accompanied a model of a Bavarian field piece, with its ammunition waggon, which, with the permission of the late Elector, I had the honour to present to the United States of North America (my native country), will give the reader a general idea of some of the alterations that were introduced, in the construction of that species of ordnance, in my attempts to improve Field Artillery.*

The model above mentioned was upon a large scale, being *one quarter of the full size* in length, diameter, &c., and it was finished, and mounted in the most complete manner, and fitted for actual service or experiment. I brought it with me to England, from Bavaria, in the autumn of the year 1798, and before it was shipped for America, I had the honour to shew it to his Royal Highness the Duke of York, commander-in-chief of his Majesty's forces in Great Britain; and to leave it several months for the inspection of the officers of the Royal Artillery.

“MEMOIR, *in which some account is given of the new Bavarian Field Pieces, lately constructed at Munich, under the direction of Lieutenant-General Count Rumford.*”

“In contriving these guns (which are 6 pounders, 18 calibres in length), the following objects were had in view: —

* This gun, with all the details of its carriage, drawn to a scale, are represented in the (annexed) Plates VII., VIII., and IX.

“ 1. To construct them in such a manner as to render them capable of being used occasionally as flying or horse artillery.

“ Provision is made for carrying occasionally all the men belonging to the gun, upon the limber, and upon the ammunition waggon, where safe and commodious seats are provided for them.

“ To save time in getting the gun into action, the two men who ride upon the limber jump down from their seat the instant the gun arrives upon the ground where it is to be posted, and unlimber, while the other men who ride on the ammunition waggon are coming up.

“ The two long pieces of ash timber, which form the principal part of the body of the ammunition waggon (uniting the fore wheels to the hind), act as springs by their elasticity; and, in order that their action may be as free as possible, they should not be shod with iron, nor should they be made too bulky.

“ The long chest in which the greater part of the ammunition is carried, and upon which five men occasionally ride, is so slung and confined by strong side braces, that if the ammunition waggon should be overturned, the men who are upon this chest — upon which they are seated astride — would be in no danger of its falling upon them.

“ Although provision is made for carrying the men belonging to these guns in cases of necessity, and transporting them with celerity from one place to another, yet it is not meant that they should be allowed to ride at all times; but merely when the guns are used as flying artillery.

“ 2. One principal object had in view was to render the gun-carriage as strong and durable as possible, without increasing its weight.

“ A bare inspection of this carriage, and a comparison of it with the carriages of field pieces on the common construction, will shew the various means that have been used to attain this important end; and that these means have been effectual has been abundantly proved by the uncommon strength which those carriages evinced when they were submitted to the most severe trials. Several of these 6 pounders were fired repeatedly with 3 lbs. of the best powder and three fit bullets, without receiving the smallest injury; while other 6 pounders of the same weight, mounted according to the common method, seldom failed to break and disable their carriages, when exposed to this trial, although the common carriage was 100 lbs. heavier than the new Bavarian carriage, — namely, 80 lbs. in iron, and 20 lbs. in wood.

“ The flasks of the carriages of field pieces are commonly much weakened by being made crooked; and also by the number of holes that are bored in them; but the new Bavarian carriage is free from both these defects. The Bavarian carriage is moreover much preserved by the collars of thick sole leather, which surround and cover the trunnions of the gun and the pivots of the elevating machine; for this soft and elastic substance, being interposed between the gun and the carriage, serves to deaden the blow of the gun against its carriage in the recoil.

“ 3. Several new contrivances were introduced with a view to expedite the management of the gun in service; and to prevent accidents and mistakes in the use of the handspikes, ram-rods, &c.

“ The handspikes (of which there are two, in order that one may remain if the other is shot away) are at-

tached to the gun-carriage, and consequently cannot be misplaced nor lost, through carelessness, nor in the hurry of action. There are no buckles to unfasten, nor cords to loosen and untie, in preparing the gun for action. — The ram-rod is fastened to the carriage in a safe and simple manner, and may be detached from it in an instant, when wanted; and the tompion of the gun, and the stopper that closes the vent, may be removed, or put into their places, with the greatest expedition.

“ Upon a comparative trial of one of these new-invented guns, with a field piece on the common construction (which trial was made in the presence of the late Elector Palatine, reigning Duke of Bavaria), it was found that, when both guns arrived on the ground at the same moment, the new gun commonly unlimbered and fired from four to six rounds before the old gun could be got ready to be fired once.

“ 4. In the mounting of this new gun, care was taken to provide for the pointing and elevating of it, in the most expeditious manner, and for the confining of it at any given elevation.

“ 5. To make provision for elevating it, to any given number of degrees or minutes, above the object against which it is pointed, without the assistance of any quadrant, plumb-line, or other instrument.

“ The elevating machine, belonging to this gun, will be found to answer perfectly for all these purposes. The thread of the elevating screw may, in all cases, be so chosen, that one turn of the screw shall elevate the gun a certain number of minutes, — as 60, for instance, — when the gun, being previously pointed directly at the object, may be elevated to any required number of degrees or minutes above it, merely by keeping an account of the

number of revolutions, and parts of revolutions, of the elevating screw that answer to the given elevation.

“ 6. In order to facilitate the pointing of the gun, when the wheels of the gun-carriage happen to be placed upon uneven ground, there are two lines of sight drawn upon the gun (one on each side of it), which are both perfectly parallel with the axis of its bore.

“ The utility of these lines must be evident to those who know how difficult it is to point a gun at a given object when one of the wheels of its carriage is higher than the other; and how much, under this circumstance (of uneven ground), a gun is necessarily thrown out of its true direction, by pointing it by means of fixed sights, or notches, situated on the upper part of the gun.

“ By means of the lines of sight, *parallel to the bore*, which are marked on these guns, the pointing of the gun may at any time be examined and corrected; for whenever the gun is properly pointed, either of the lines of sight will carry the eye either against the object (namely; in very small distances) or perpendicularly over it.

“ 7. As it frequently happens that the wheels of gun-carriages are wounded and disabled in action, in order that a speedy remedy may be applied in those cases, in the Bavarian artillery, the wheels of the gun-carriages of the field pieces are of the same form and dimensions, precisely, as the wheels of their limbers, and the hinder wheels of their ammunition waggons, in order that these last may be taken occasionally to replace the former.

“ 8. In the construction of the new Bavarian artillery, all useless reinforce rings upon the gun have been omitted, and pains have been taken to make its form as simple as possible.

(Signed,)

“ RUMFORD.

“BROMPTON, 26th August, 1799.”

But my attempts to improve artillery were not confined to the *form* of the gun, and its carriage; — the change that might be made, with advantage, in the *material* employed in constructing cannon for the land service, was likewise a subject of experiment which engaged my attention.

Happening to be present many years before, when the late Admiral Darby, in a large company of Admirals and Captains of the navy, expressed his *great satisfaction* at having *at length* succeeded in his attempts *to get rid of the brass guns*, which, for many years after iron ordnance had been generally substituted for brass, in the navy, the Britannia (the Admiral's ship) had continued to carry, on her lower gun-deck: the conversation to which this incident gave rise, concerning the relative merit of iron and brass guns, made a lasting impression on my mind; and as soon as it was in my power, I did not neglect to make such experiments as I conceived would be sufficient to determine a question that appeared to me to be of very great magnitude indeed.

I had conceived an idea that IRON ordnance might, with much advantage, be substituted instead of BRASS, for field artillery, and in general for all kinds of artillery.

I made some experiments with a view to the ascertaining of that fact, during the time I served with my regiment in the American war, but these were upon too confined a scale to be decisive; as far, however, as they went, they tended to confirm the favourable opinion I had conceived of the usefulness of iron guns in the land service. The Hon. Admiral Digby, having been so kind, at my solicitation, as to lend me two *twelve pounder* carronades, I mounted them as howitzers, and

found them to be very useful guns, especially when they were fired with a *grape* composed of 6 or of 9 *pound balls*; but at Munich these experiments were made on a much more extensive scale.

It had been asserted by those who did not approve of the introduction of iron ordnance for the land service, that, although iron guns of a very large calibre, such as are used on shipboard, are found to be sufficiently strong, yet smaller guns, such as would be proper for field artillery, would be very liable to burst, if they were not made much heavier than brass guns of the same bore; which would render them unwieldy, and unfit for those rapid movements which are often so decisive on a day of action.

Were this objection founded, it would undoubtedly be decisive against the general introduction of iron guns; but from all the inquiries I could make I thought there was reason to conclude that *want of strength*, which was certainly very apparent in iron guns of inferior dimensions, arose from accidental circumstances; and that an effectual remedy might easily be found for that imperfection.

Until iron guns were cast *solid*, or without a core, no hopes could reasonably be entertained of being able to cast small guns of that metal so sound, and to render their texture so uniform throughout, as to enable them to resist the force of their customary charges, without reinforcing them with an unusual quantity of metal; and even after iron guns of all calibres were cast solid, yet, as the strength, or toughness, of cast-iron depends much on the *slowness with which it cools in the mould*; and as small masses cool more rapidly than larger ones, it is evident that guns of a small size would be much more

likely to be wanting in strength than larger cannon of a similar form ; but I never could see any reason for supposing that a small piece of iron ordnance would be wanting in strength, if means were employed for pressing the metal with a considerable weight while it remains in the mould in a fluid state ; and for prolonging the time of its cooling.

When cannon are cast of gun-metal, or brass, the solid cylinder, or rather cone, which, when bored, constitutes the gun, is cast at least 2 feet longer than it is intended that the gun should be. The additional piece of metal beyond the end of the muzzle, which is cut off before the gun is bored (and thrown away, or rather preserved and melted again), serves to compress the fluid mass in the lower part of the mould, and to force upwards those bubbles of air that are frequently carried down into the mould with the descending current of melted metal ; and which, if they were not expelled, would form what are called *honeycombs* in the metal ; and would render the gun unsound and unserviceable.

The mould is always placed in a vertical position, with that end upwards which is to be the muzzle of the gun, in order that the soundest part of the metal—namely, that which, having sustained the greatest pressure while the metal remained in a fluid state, is most effectually freed of air-bubbles—may be in the neighbourhood of the chamber of the piece, where strength and soundness are most wanted.

The utility of these precautions being evident, they were not neglected in casting the iron guns that were constructed for my experiments ; and means were used for prolonging the time of the cooling of the metal in the mould.

The guns cast were 1 pounders, 3 pounders, 6 pounders, 12 pounders, and one 18 pounder; and to make the comparison with brass artillery the more striking and satisfactory, they were all—except the 1 pounders and the 18 pounder—made of the same lengths, and of the same weight, as brass guns of the same calibres.

These iron guns were all *cast solid*, and were bored in an horizontal position; and while the gun was boring, the swelling of its muzzle, and the first reinforce ring (at the breech) were neatly turned. The forms of all these guns were simple, and not inelegant. Their trunnions were placed in such a manner that a line passing through their axes meets the axis of the bore of the gun, and cuts it at right angles. The trunnions were *turned*, and their forms and dimensions made perfectly true, by means of a particular machine, contrived for that purpose.

To protect the trunnions and the gun-carriage from the violence of the blow which the carriage receives from the gun in its recoil, the trunnions were covered with thick sole leather, greased with tallow; and the trunnion plate was made to fit the trunnion—when thus covered with leather—as accurately as possible. The elevating screw was so attached to the cascable that the gun was completely confined, and prevented from kicking up, which probably contributed not a little to the protection of the carriage.

When these iron guns were mounted, — and not before,* — they were *proved*; and they all sustained, with-

* As it is not common to mount guns before they are proved, it is right that the reader should know why this usual and necessary precaution was neglected in this instance. It was done to surprise and confound those who were disposed to criticise, and prepared to oppose. It was, no doubt, a bold measure, but bold measures are sometimes the most prudent. The 18 pounder was not submitted to these severe trials.

out the smallest injury, the most severe proof that ever had been given to brass guns of the same weights, lengths, and calibres. They were then *fired, quick*, at the shortest possible intervals, with half the weight of their bullets in powder, and three fit bullets, one upon the other, but *not one of them burst in these severe trials*; nor were any of their carriages injured. One of the 6 pounders, 16 calibres in length, and weighing 720 lbs., was then taken from its carriage, and being laid on the ground, was twice fired, once with 6 lbs. of powder and two bullets; and once with the same charge of powder and three bullets; — but these attempts to burst it were fruitless.

The result of these experiments having removed all the doubts that were entertained respecting the strength of these guns, their accuracy in shooting was now tried. They were repeatedly fired both with round, and with cannister-shot against a mark, placed at different distances; and they were unanimously declared by all present at these trials, to be quite equal, for accuracy, to the best brass ordnance.

Several of them were afterwards used in actual service, and were found to be as complete and as useful guns as any in the service.

The 1 pounders — which were on a peculiar construction — were much used in the defence of Mannheim; and they became at last such favourites with the corps of artillery, that the men on duty actually made interest with their officers to be stationed at them. These small guns were about 4 feet long in the bore; and although their calibre was that of an *one pound* iron bullet, they weighed as much as one of the *3 pounders*, and were commonly fired, in service, with *three* bullets at a time, which they carried with surprising accuracy.

When the object at which they were pointed was at a great distance, single leaden bullets were used, which, in order that they might fit the bore with greater precision, were wrapped up in thin leather, greased with tallow, or soaked in oil.

The carriage of this gun was extremely simple, being a single piece of elm timber, fastened to an iron axle. The wheels were of the same height and strength as those used for the carriages of 3 pounders.

From this description it will be evident that this little gun bears a near resemblance to the *Ammulette* invented by the late Lieutenant-General Desaguliers, and constructed at Woolwich. The fact is, that they were copied, with a few trifling alterations, from that piece of ordnance, being made after a drawing of it which was given me by the Lieutenant-General three and twenty years ago. He, no doubt, took the idea of this gun from the reveries of Marshal Saxe.

The iron 18 pounder constructed at Munich — which was intended merely as an experiment — was very short, being only 10 calibres in length, and it was mounted in a very singular manner. It was intended for covering troops retreating before an advancing enemy, and is so contrived that it can be fired without stopping, or while it is *in full march*. It has indeed often been fired, and very quick too, while the horses which drew it were in full gallop. The carriage, which is upon four wheels, serves at the same time as an ammunition waggon; and also for carrying the men who serve the gun. These, however, are only *three* in number, and more are not wanted.

After discharging the piece, upon pulling a strap, the gun, of itself, falls into a vertical position, with its

muzzle upwards. The cartridge is then put into it, and by its weight falls into its place; the ball, grape, or canister, with which the gun is loaded, falling into the conical opening of the chamber, there sticks fast, and is firmly fixed and confined in its place. By means of another strap, or rope, the breech of the gun is raised, with the strength of one man, and the piece is brought again into an horizontal situation (or to any given elevation); where, by means of a rack (in the form of the limb of a quadrant) and a catch, it is confined, and ready to be again discharged. Upon drawing back this catch, after the piece has been fired, the gun falls again into a vertical position.

The carriage is so constructed that the gun may, with great facility, be pointed several degrees, either to the right or to the left of the line of the direction of the march, without altering the direction in which the horses are going on.

The gun requires no priming, being fired by means of a pistol, constructed for that purpose; the flame of which is impelled with such violence through the vent of the gun, that it never fails to pierce the thick woollen bag, which contains the powder, and to set fire to the charge.

This piece carries canister-shot with great effect, but the charge, which to me appeared to be most formidable, and best calculated to intimidate an enemy, was a grape, consisting of 9 *two pound* iron bullets; for as these balls are sufficiently large to rebound from the ground, or *recocheter*, several times, especially when the gun is not much elevated, they bound on to a great distance; and as they exhibit all the appearances of cannon bullets to the spectators who see them arrive among

them, and produce nearly the same effects as much larger bullets, where they take place against either cavalry or infantry, it is very likely, I think, that two or three of these guns, well plied with this grape, would make an advancing column of very brave troops hesitate, even though they should come on flushed with victory.

I had contrived a gun, on these principles, that could be fired *advancing*, as well as *retreating*, in full march; but as I am not now writing a treatise on artillery, it would be improper for me to enlarge farther on the subject.

I cannot finish this Paper, without just observing, with respect to iron guns, that if any country could safely venture to substitute iron ordnance instead of brass, for field artillery, it would be Great Britain; for the manufacture of cast-iron is now carried to such perfection in this island that it is made, at pleasure, of almost any degree of hardness or softness; and if the saving of copper can *anywhere* be an object of public importance, it must be here, where so much of that metal is used in covering ships.

For my own part, I do not hesitate to say, that I think iron guns better than brass guns, in every respect; when the metal is as good as it may be easily made; and they are certainly much more durable, and cost incomparably less. They are likewise more easily destroyed and rendered useless (by knocking off their trunnions) when it becomes necessary to abandon them.

I well know that these opinions will not meet with the general approbation of those who, no doubt, ought to be considered as the proper and only competent judges in matters of this kind; yet I may be permit-

ted to say that my opinions have not been lightly taken up, nor hastily formed. I submit them to professional men, with that deference which is due from an individual to so numerous and so respectable a corps of gentlemen.

EXPERIMENTS

ON THE

PRODUCTION OF AIR FROM WATER,

EXPOSED WITH VARIOUS SUBSTANCES TO THE ACTION
OF LIGHT.

VARIOUS opinions having been entertained with respect to the origin of the air produced by exposing healthy vegetables in water to the action of the sun's rays, according to the method of Dr. Ingen-Housz, and not being myself thoroughly satisfied with any of the theories proposed for explaining the phænomena, I made the following experiments with a view to throwing some new light upon that subject.

Having found by accident that raw silk possesses a power of attracting and separating air from water in great abundance when exposed in it to the action of light, it occurred to me to examine the properties of this air, and to consider more attentively the circumstances attending its production, thinking that this might possibly lead to some further discoveries, relative to the production of the air yielded by water, under other circumstances; and though my success in these inquiries has not been equal to my wishes, yet, as in the course of my researches I have discovered some facts which I take to be new, and as I have confirmed others already known by a variety of new experiments, I flatter myself that an account of my labours upon this subject will not be thought altogether uninteresting.

Before I enter upon the detail of my experiments, it will be necessary to premise that I shall in general confine myself merely to the facts as they present themselves, without applying them to the confirmation or refutation of the theories of others, and without entering into any speculative inquiries relative to their remote causes; and in describing the different appearances I shall make use of the most familiar terms. Thus, in speaking of the air produced upon exposing raw silk in water to the action of light, I shall sometimes mention it as being yielded by the silk; and I shall sometimes speak of the air furnished by exposing water, which has previously turned green in the sun's rays, as being immediately produced by the water, though it is probable that the *green matter* acts a very important part in the production of this air in the one case and perhaps in the other. But how it acts is not well ascertained; and I had in general much rather confine myself to a simple and even an unlearned description of facts, than, by endeavouring to give more precise definitions, at first, to involve myself in all the difficulties which would attend an attempt to account for phænomena whose causes are but very imperfectly known.

Experiment No. 1.

My first object was to collect a sufficient quantity of the air, separated from water by silk, to determine its goodness by the test of nitrous air; and to this end having filled with clear spring-water a globe of thin, white, and very transparent glass, $4\frac{1}{2}$ inches in diameter, with a cylindrical neck $\frac{3}{4}$ of an inch in diameter, and about 12 inches long, I introduced into it 30 grains of raw silk, which had been previously washed in water in order to

free it of air ; and inverting the globe under water, and placing its neck in a glass jar containing a quantity of the same water with which the globe was filled, I exposed it in my window to the action of the sun's rays, and prepared myself to examine the progress of the generation or production of the air.

The globe had not been exposed ten minutes to the action of the sun's rays, when I discovered an infinite number of exceedingly small air-bubbles, which began to make their appearance upon the surface of the silk ; and, these bubbles continuing to increase in number and in size, at the end of about two hours, the silk, appearing to be entirely covered with them, rose to the upper part of the globe.

These bubbles going on to increase in size, and running into each other, at length began to detach themselves from the silk, and to form a collection of air in the upper part of the globe ; but, the measure of my eudiometer being rather large, it was not till after the globe had been exposed in the sun near four days, that a sufficient quantity of air was collected to make the experiment with nitrous air, in order to ascertain its goodness by that test.

Having at length collected a sufficient quantity of this air for that purpose, I carefully removed it from the globe, and mixing with 1 measure of it 3 measures of nitrous air, they were reduced to 1.24 measures ; which shews that it was actually *dephlogisticated air*,* and of a considerable degree of purity.

Common air, tried at the same time, 1 measure of it with 1 measure of nitrous air were reduced to 1.08 measure.

* It must be remembered that this was written in the year 1786, at which period this elastic fluid was generally denominated *dephlogisticated air*.

Having again exposed the globe, with the same water and silk, in my window, where the sun shone the greatest part of the day, at the end of three days I had collected $3\frac{3}{4}$ cubic inches of air, which, proved with nitrous air, gave $1 a + 3 n = 1.18$; that is to say, 1 measure of this air *added to* 3 measures of nitrous air were reduced to 1.18 measure.

A wax taper, which had been just blown out, a small part only of the wick remaining *red-hot*, upon being plunged into a phial filled with this air immediately took fire, and burnt with a very bright and enlarged flame.

The water in the globe appeared to have lost something of its transparency, and had changed its color to a very faint greenish cast, having at the same time acquired the odour or fragrance proper to raw silk.

This experiment I repeated several times with fresh water (retaining the same silk), and always with nearly the same result; with this difference, however, that when the sun shone very bright, the quantity of air produced was not only greater, but its quality likewise was much superior to that yielded when the sun's rays were more feeble, or when they were frequently intercepted by flying clouds. The air, however, was always not only much better than common air, but better than the air in general produced by the fresh leaves of plants exposed in water to the sun's rays, in the experiments of Dr. Ingen-Housz; and under the circumstances the most favourable, it was so good that 1 measure of it required 4 measures of nitrous air to saturate it, and 3.65 measures of the two airs were destroyed; or, proved with nitrous air, it gave $1 a + 4 n = 1.35$, which, I believe, is better than any air that has yet been produced in the experiments with vegetables.

The method I have here adopted of using algebraic characters in noting the result of the experiments made to determine the goodness of air, though not strictly mathematical, is very convenient; and for that reason I shall continue to make use of it. a represents the air which is proved; n nitrous air; and the numbers which are joined to these letters shew the quantities or the number of measures of the different airs made use of in the experiment. The other number, which stands alone, or without any letter attached to it, on the other side of the equation, shews the volume, or the number of measures and parts of a measure to which the two airs are reduced after they are mixed. I shall sometimes add a fourth number, shewing the quantities of the two airs destroyed, as this more immediately shews the goodness of the air which is proved.

Thus, in the experiment last mentioned, 1 measure of the air proved, mixed with 4 measures of nitrous air, were reduced to 1.35 measure; consequently, 3.65 measures of the two airs were destroyed, for it is $1 + 4 = 5 - 1.35 = 3.65$; and the result of this trial I should write thus, $1 a + 4 n = 1.35$ or 3.65 .

Or, for still greater convenience in practice, as this last number 3.65, or $3\frac{65}{100}$, shews more immediately the goodness of the air in question, as I have just observed, by supposing with Dr. Ingen-Housz the measure of the eudiometer to be divided into 100 equal parts, it will be $100 a + 400 n = 135$; and 365, expressing the volume of the two airs destroyed, will become a whole number.

But, instead of writing $100 a + 400 n = 135$, &c., I shall continue to write $1 a + 4 n = 1.35$, and shall express the last number (3.65) as a whole number notwith-

standing ; and I shall sometimes (following the example of Dr. Ingen-Housz) write this number *only*, in noting the goodness of any air in question.

I would just observe, with respect to the process of proving the goodness of any kind of air by the test of nitrous air, that I mix the two airs in a phial about 1 inch in diameter, and 4 inches long, putting the air to be proved into the phial first, and then introducing the nitrous air, one measure after another, till the volume of the two airs, after the diminution has taken place, amounts to more than *one* measure and is less than *two* measures.

Immediately after the introduction of each measure of nitrous air, I give the phial a couple of shakes ; after which I suffer it to stand at rest, while I prepare another measure of nitrous air, which commonly takes up about 20 seconds.

The measure of the eudiometer being filled with air, I suffer it to remain quiet under water 15 seconds, or while I can leisurely count 30, in order that the air may have time to acquire the temperature of the water in the trough, and that the water in the measure may have time to run down from the sides of the glass tube ; and in shutting the slide of the eudiometer, I take care to bring it out to be exactly even with the surface of the water in the trough. Similar precautions are likewise made use of in measuring the volume of the two airs in the tube of the eudiometer, after they have been mixed and diminished in the phial.

In order that I may know when I have added nitrous air enough to the air in the phial, so that the volume of the two airs may amount to 1 measure, and may not be greater than 2 measures, there are two marks upon the

phial, made with the point of a diamond, the one shewing 1 measure of my eudiometer, the other shewing 2 measures.

The tube of my eudiometer is half an inch in diameter internally, and 1 measure occupies $3\frac{1}{4}$ inches in length upon it, and the measure itself is made of a piece of the same tube. Both the one and the other are ground with fine emery on the inside, in order to take off the polish of the glass, and by that means facilitate the running down of the water, which might otherwise hang in drops upon the inside of the tube upon the introduction of air.

The nitrous air was always fresh made, and of the same materials, *viz.* fine copper wire dissolved in smoking spirits of nitre, diluted with 5 times its volume of water; and all possible attention was paid to every other circumstance that could contribute to the accuracy of the experiments.

I have thought it necessary to mention these particulars, on account of the great difference in the apparent goodness of any kind of air, proved by the test of nitrous air, which arises from the difference of the circumstances under which the experiments are made.

But to return to my experiments upon the air produced upon exposing silk in water to the action of the sun's rays.

Experiment No. 2.

Finding that the quantity and the quality of the air produced depended in a great measure upon the intensity of the light by which the water and the silk were illuminated, I was desirous of seeing whether, by depriving them entirely of all light, they would not at the same time be deprived of the power of furnishing air. To

ascertain this fact, I took a globe A, similar to that made use of in the foregoing experiment, and having filled it with fresh spring-water, I introduced into it 30 grains of raw silk, and placing it with its cylindrical neck inverted in a jar filled with the same water, I covered the whole with a large, inverted earthen vessel, and exposed it, so covered up, for several days, in my window, by the side of another globe B, containing a like quantity of water and silk, which I left naked, and consequently exposed to the direct rays of the sun.

The result of this experiment was, that the water and silk in the globe exposed to the sun's rays furnished air in great abundance, as in the experiment before mentioned; while that in the globe covered up in darkness produced only a few very inconsiderable air-bubbles which remained attached to the silk.

Experiment No. 3.

To see if heat would not facilitate the production of air in the globe sheltered from the light, I now removed it from the window, and placed it near a German stove, where I kept it warmed to about 90° of Fahrenheit's thermometer for more than 24 hours; but this was all to no purpose. The air produced was so exceedingly small in quantity that it could neither be proved nor measured, there being only a few detached air-bubbles which had collected themselves near the top of the globe.

The mean heat of the water in the globe exposed in the sun's rays, at the time when it furnished air in the greatest abundance, was about 90° Fahrenheit. It was sometimes as high as 96° ; but air was frequently produced in considerable quantities when the heat did not exceed 65° and 70° .

Experiment No. 4.

Finding by the last experiment (No. 3) that heat alone, without light, was not sufficient to enable silk in water to produce air, I was desirous of seeing the effect of light without heat upon them. To this end, I took the globe B, with its contents, and, plunging it into a mixture of ice and water, brought it to the temperature of about 50° F. and taking it out of this mixture, and exposing it immediately in the sun's rays (which were very piercing at the time), I entertained it in this temperature above two hours by the occasional application of cloths, wet in ice-water, to the lower part of the globe.

Notwithstanding this degree of cold, a considerable quantity of air was produced; though it was not furnished in so great abundance as when the globe was suffered to become hot in the sun's rays.

Having thus ascertained the great effect of the sun's rays in the production of the air furnished upon exposing silk in water to their influence, my next attempt was to determine whether this arose from any peculiar quality in the sun's light; or whether *other light* would not produce the same effect. With a view to ascertain this point, which I conceived to be of very great importance, I made the following interesting experiment.

Experiment No. 5.

Having removed all the air from the globe B, and having supplied its place with a quantity of fresh water, so as to render it quite full, I replaced it, inverted, in its jar, and, removing it into a dark room, surrounded it with 6 lamps, with reflectors, and 6 wax-candles, placed at different distances, from 3 to 6 inches from it, and so disposed as to throw the greatest quantity of light pos-

sible upon the silk in the water, taking care at the same time that the water should not acquire a greater heat than that of about 90° F. Things had not remained in this situation above 10 minutes, when I plainly discovered the air-bubbles beginning to make their appearance upon the surface of the silk, and at the end of 6 hours there was collected at the upper part of the globe a quantity of air sufficient to make a proof of its goodness with nitrous air; and, upon trial, I had the pleasure to find that it was *dephlogisticated*, and of such a degree of purity that 1 measure of it with 3 measures of nitrous air occupied no more than 1.68 measure.

I afterwards exposed to the same light, in small inverted glass jars, filled with water, a fresh-gathered healthy leaf of the peach-tree, and a stem of the pea-plant, with three leaves upon it; and both these vegetables furnished air in the same manner as they are known to furnish it when exposed, under similar circumstances, to the action of the sun's direct rays, but in less quantities, which I attribute to the greater intensity of the sun's light above that of my lamps.

The experiment with the silk and water I repeated several times, always with nearly the same result. The quantity of air furnished was sometimes a little greater and sometimes a little less, but it was always in much greater abundance than that furnished by an equal quantity of water and silk exposed to the same heat, but excluded from the light; and I have reason to think it was of a much superior quality, though the quantity of that produced in the dark was too small to be submitted to any proof.

These experiments appear to me to be of so much im-

portance, that I could wish they might be repeated and varied in such a manner as thoroughly to establish the facts relative to the subject in question. For my part I would most readily undertake the investigation of the matter; but, being employed in another pursuit (the continuation of my Experiments upon Heat), and, besides this, much of my time being taken up by the duties of my military employment, I have not leisure at present for such an undertaking.

Perhaps it may be proved by future experiment that the matter of light is a constituent part of what is called pure or dephlogisticated air; if so, may we not venture to conclude with M. Scheele, that the *light*, as well as the heat, produced by flame, and in general all burning bodies, arises *solely* from the decomposition of this air, and not from the phlogiston or inflammable principle of the body which is burnt? There are many phænomena which would seem to justify this opinion.

But to proceed in the account of my experiments. The operation of inverting the globes under water, and placing them in the jars, and of displacing and replacing them upon removing the air produced, being attended with some inconveniences, I had recourse to another method of disposing of the apparatus, much more simple and more convenient. The globes, being filled, were laid upon a small piece of deal board, with their necks inclined at an angle of about 20° above the plane of the horizon, and supported in this position by a perpendicular fork of wood fixed to the end of the board, as represented by the following figure. The part of the board upon which the under part of the globe reposed was hollowed a little, to prevent the globe from rolling; or, what I found more safe and convenient, a small ring

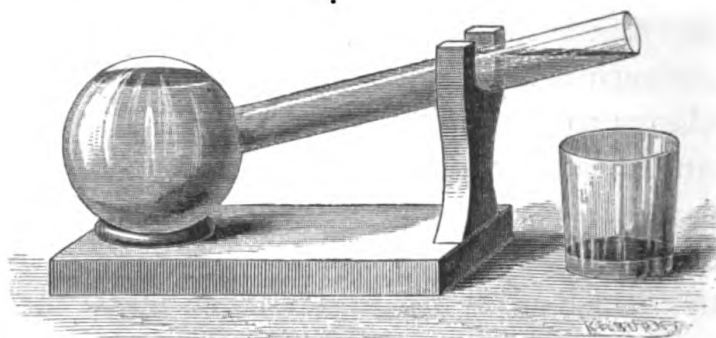

or hoop of soft wood was nailed down upon the board in that part.

By this arrangement the jars were spared, and the end of the neck of the globe being easy to be come at, by introducing a wire, or, what I commonly made use of in preference, a small glass tube, into the globe, the air hanging attached to the silk can at all times be separated from it; which is often necessary, in order to determine with greater precision the quantity of air furnished in any given time.

The air produced naturally rises to that part of the globe which is uppermost, where it collects in a body, driving out an equal volume of water; which, to prevent its running about, may be collected by placing a proper vessel under the mouth, or end of the neck of the globe, to receive it.

The method of removing the air from the globe is too well known to require a description. I would, however, observe that, in doing it, care should be taken that the water in which the globe is immersed be quite clean, and of the same kind with that in the globe, otherwise that which enters the globe, to replace the air removed, might derange the experiment.

Having provided myself with a number of globes of different sizes, all fitted with boards or stands to support

them in the manner above described, I proceeded in the course of my experiments as follows.

Finding that raw silk, exposed in water to the action of light, causes the water to yield pure air in so great abundance, I was desirous of finding out whether this arose from any peculiar quality possessed by the silk ; or whether other bodies might not be made to produce the same effect : to this end, having provided 6 globes, each about $4\frac{1}{2}$ inches in diameter, and having filled them with fresh spring-water, I introduced into them the following substances, and exposed them all at the same time to the action of the sun's rays.

In the globe No. 1. I put 15 grains of sheep's wool,
No. 2. — 15 grains of eider-down,
No. 3. — 15 grains of the fine fur of a
Russian hare,
No. 4. — 15 grains of cotton-wool,
No. 5. — 15 grains of lint or the ravel-
ings of fine linen,
No. 6. — 15 grains of human hair ;
these substances being all well washed, and being thor-
oughly freed of air by being wetted before they were put
into the globes.

The results of these experiments were as follows.

Experiment No. 6.

The globe No. 1, which contained the sheep's wool, did not begin to furnish air in any considerable quantity till the third day of its being exposed to the action of the sun's rays ; and, several days of cloudy weather interven-
ing, I did not remove the air till the eighth day, when I collected $1\frac{3}{4}$ cubic inch, which, proved with nitrous air, gave $1 a + 3 n = 1.28$, or 272 degrees.

The wool at no time furnished more than one-third part of the air which an equal quantity of silk would have furnished under the same circumstances.

The water was very faintly tinged of a greenish hue.

Experiment No. 7.

The water in the globe No. 2, with the eider-down, began almost immediately to furnish air, and continued to yield it during the whole time of the experiment nearly in as large quantities as the water with silk had done in the former experiments, and nearly of the same quality. $1\frac{3}{4}$ cubic inches of this air, furnished the eighth day from the beginning of the experiment, or the third of sunshine, proved with nitrous air, gave $1 a + 3 n = 1.34$, or 266 degrees of purity.

The water was faintly tinged of a greenish, yellowish cast; and the eider-down, when examined attentively, appeared to be covered with a greenish slime.

Experiment No. 8.

The globe No. 3, with the hare's fur (which was white), furnished more air than the sheep's wool, but not so much as the eider-down. After four days of sunshine, I collected 2 cubic inches of this air, which, proved with nitrous air, gave $1 a + 3 n = 1.44$, or 256.

The water had acquired a very faint yellowish hue; but it did not appear to have lost much of its transparency, or to be disposed to deposit any sediment.

The air produced in this experiment made its appearance in a different manner from that furnished in those preceding it, the air-bubbles which appeared upon the surface of the fur being at considerable distances from each other, and growing to an uncommon size before

they detached themselves to rise to the surface of the water.

Experiment No. 9.

The globe No. 4, with cotton-wool, furnished a considerable quantity of air, which appeared to be better than that furnished by any of the five other globes. Proved with nitrous air, it turned out $1 a + 3 n = 1.07$, or 293, and, what was particular, the water did not appear to have altered its colour in the least, or to have lost anything of its transparency.

Experiment No. 10.

The globe No. 5, with ravelings of linen, was very tardy in furnishing air, and produced but a small quantity; at the end of a fortnight, however, I collected about 2 cubic inches, which, proved with nitrous air, gave $1 a + 3 n = 1.51$, or 249.

The air appeared to have very little disposition to fix itself to the surface of this substance. It was very seldom that there were air-bubbles enough attracted to it to cause it to rise to the surface of the water, and the few bubbles which occasionally made their appearance very soon disappeared upon the diminution of the light and heat of the sun. In short, it appeared that there is but a very feeble attraction between this substance and the particles of air, at least when they are dissolved in water. Whether this arises from the superior affinity of the substance to water or not, I will not pretend to decide; but it appears to be probable, as there is so strong an attraction between water and linen, or flax, which is apparent from the avidity with which a piece of dry linen drinks up that fluid, and becomes wet even to a considerable distance when one end of it only is placed in water.

It must be remembered that I here consider the separation of the air from water as a simple operation ; and that I do not take into the account the purification, or rather the generation, of this air. Though there is great reason to conclude that these two operations are very nearly connected, yet, to simplify my inquiries, I shall, in the first place, consider the appearances as they presented themselves to my senses. It will be easy afterwards to draw any conclusions from the results of the experiments which a careful examination and comparison of the various phænomena will justify.

Experiment No. 11.

The globe No. 6, with human hair, furnished still less air than that with ravelings of linen in the last-mentioned experiment ; but notwithstanding the smallness of the quantity, it was considerably superior in quality to atmospheric air, for, proved with nitrous air, it gave $1 a + 2 n = 1.45$, or 155, whereas common air proved at the time gave $1 a + 1 n = 1.08$, or 92.

Experiment No. 12.

To ascertain the relative goodness of the air furnished by the water in these experiments, and of that produced by exposing fresh healthy vegetables, in water, to the action of the sun's light, according to the method of Dr. Ingen-Housz, I collected a small quantity of air from a stem of a pea-plant, which had four healthy leaves upon it, exposed in water to the sun's light, and found it to be much inferior to that furnished in the experiments with silk and the various other substances I made use of. Proved with nitrous air, it gave $1 a + 2 n = 1.05$, or 195.

An entire plant of housewort, of a moderate size, ex-

posed in 12 ounces of water 7 hours to the action of the sun's rays, at a time when the weather was remarkably fine and very hot, furnished about $\frac{3}{4}$ of a cubic inch of air, which was so much worse than common air, that 1 measure of it with 1 measure of nitrous air occupied 1.36 measures; or it was $1 a + 1 n = 1.36$, or 64. But I lay no kind of stress upon the result of this experiment, as it is more than probable that the badness of the air arose from the roots of the plants; for from the leaves alone I have frequently since obtained air which appeared to be considerably better than common air.

From the leaves of the peach-tree I obtained an air, which, proved with nitrous air, gave $1 a + 2 n = 1.32$, or 168; but I did not think it necessary to multiply these experiments, particularly as Dr. Ingen-Housz and Mr. Sennebier have given us the results of so many of theirs upon the same subject, of the accuracy of which there is no room left to doubt. I shall, therefore, content myself with referring to the results of their experiments.

With a view to determining, with greater precision, the quantity and quality of the air produced by a given quantity of water and of silk, exposed for a given time to the action of the sun's rays, I made the following experiment.

Experiment No. 13.

A globe of fine, clear, white glass, about $8\frac{3}{10}$ inches in diameter, and containing 296 cubic inches, being filled with fresh spring-water and 30 grains of raw silk, was exposed in my window three days, *viz.* 12th, 13th, and 14th of May last (1786), these days being for the most part cold and cloudy, with short intervals of sunshine.

Air produced, $9\frac{1}{2}$ cubic inches ; quality, $1 a + 3 n = 1.61$, or 239.

May 15. This air being removed, and its place supplied with fresh water, the globe exposed in the sun this day, from nine o'clock in the morning till five o'clock in the afternoon, the weather being very fine, yielded $8\frac{46}{100}$ cubic inches of air, which, proved with nitrous air, gave $1 a + 4 n = 1.74$, or 326. The heat of the water in the globe, during the experiment, was from 70° to 98° F. The water had now lost considerably of its transparency, and had assumed a light greenish hue.

May 16. The air furnished yesterday being removed, the globe furnished this day, during six hours of sunshine, 9 cubic inches of air, which, proved with nitrous air, gave $1 a + 4 n = 1.44$, or 356.

May 17. The globe furnished this day, during $3\frac{1}{2}$ hours of sunshine, 6 cubic inches of air, of a very eminent quality ; for, proved with nitrous air, it gave $1 a + 4 n = 1.35$, or 365.

May 18. This day cold and cloudy ; not more than $1\frac{1}{2}$ hours sunshine ; air produced $\frac{3}{4}$ of a cubic inch ; quality $1 a + 4 n = 1.56$, or 344.

May 19. The globe appearing now to be quite exhausted of air, shewing no signs of furnishing any additional quantity, though exposed to the action of a very bright sun, I removed the globe from the window, and placed it by the side of a German stove, where it was kept warm to 100° F. from 10 o'clock in the morning till 5 o'clock in the afternoon. By this means, I obtained $\frac{1}{4}$ of a cubic inch of air, which, proved with nitrous air, gave $1 a + 4 n = 1.74$, or 326.

Not being able to obtain any more air from the globe, I now put an end to the experiment.

The quantities and qualities of the airs furnished upon the different days were as follows: —

	Quantity.	Quality.
Upon the 12th, 13th, } and 14th of May }	$9\frac{1}{2}$ cubic inches	$1 a + 3 n = 1.61$, or 239
15th . . .	$8\frac{4}{100}$. . .	$1 a + 4 n = 1.74$, or 326
16th . . .	9 . . .	$1 a + 4 n = 1.44$, or 356
17th . . .	6 . . .	$1 a + 4 n = 1.35$, or 365
18th . . .	$\frac{3}{4}$. . .	$1 a + 4 n = 1.56$, or 344
19th . . .	$\frac{1}{4}$. . .	$1 a + 4 n = 1.74$, or 326
Total quantity	$33\frac{9}{100}$ mean qual.	$1 a + 4 n = 1.84$, or 316

As in this experiment the air furnished each day was removed at night, and the place it occupied in the globe supplied with fresh water, I was desirous of seeing what variation it would occasion in the result of the experiment, if, instead of removing the air from time to time, I suffered it to remain in the globe till the end of the experiment; to this end I made

Experiment No. 14.

In which the globe being filled with fresh water, and the silk used in the last experiment (being first well washed), the whole was exposed four days to the action of the sun's rays, the weather being remarkably fine and very hot. Upon removing the air produced, I found it amounted to $30\frac{1}{10}$ cubic inches; and its quality, proved with nitrous air, was $1 a + 3 n = 1.02$, or 298.

I should have continued the experiment for some days longer, as the globe did not appear to be exhausted; but the quantity of air already collected in the globe was so great that it became very difficult to remove it, without running the risk of losing a part of it, or of letting the air of the atmosphere enter the globe, either of which events would, of course, have spoiled the experiment.

For safety, therefore, and that I might not by an accident lose the trouble I had already had with it, I put an end to the experiment at the end of the fourth day.

The water had lost of its transparency, and had acquired a greenish cast, as in the last experiment; and in both these experiments I observed that a considerable quantity of whitish yellowish earth was precipitated from the water, which, falling to the bottom of the globe, attached itself to the glass in such a manner that it was with difficulty that it could be removed. These were general appearances, and took place in all cases, in a greater or less degree, where a considerable quantity of pure air was separated from water by the influence of light.

Experiment No. 15.

The silk made use of in the last experiment having been frequently used in the foregoing experiments, I was desirous of seeing the effect of making use of fresh silk; and also of varying the proportion between the quantity of silk, the quantity of water, and the size of the globe; accordingly at 6 o'clock, P. M., upon the 13th of June, I filled a small globe, about three inches in diameter, or (to ascertain its size more exactly), which contained just 20 cubic inches, with fresh spring-water, and 17 grains of raw silk, wound in a single thread, which had never been put into water, or otherwise used, since it came out of the hands of the silk-winder.

At the end of four days, *viz.* the 14th, 15th, 16th, and 17th of June, this globe had only furnished $\frac{1}{4}$ of a cubic inch of air, which, proved with nitrous air, gave $1 a + 1 n = 1.32$, or 68; consequently, was much worse than common air.

Upon the 18th it began to produce good air, and dur-

ing six hours of sunshine it furnished $1\frac{15}{100}$ cubic inches, which, proved with nitrous air, gave $1 a + 3 n = 1.15$, or 285.

The two following days (*viz.* the 19th and 20th of June), it furnished $1\frac{27}{100}$ cubic inch of air, which, proved with nitrous air, gave $1 a + 3 n = 1.37$, or 263; after which it totally ceased to yield air, though exposed for several days in the sun's rays.

Total quantity of air produced, $2\frac{67}{100}$ cubic inches; mean quality, $1 a + 3 n = 1.46$, or 254.

By this experiment it appears that raw silk, when used for the first time, does not immediately dispose the water to yield pure air; on the contrary, that it phlogisticates the air yielded by water to a very considerable degree; and this I afterwards found to be the case with several other substances.

Though the quality, at a medium, of the air furnished in this experiment was not quite so good as that furnished in the two experiments last mentioned (*viz.* No. 13 and No. 14), yet its quantity, in proportion to the quantity of water made use of, was greater than in either of them; it amounted to something more than *one eighth* of the volume of the water.

Of all the substances I had hitherto made use of in these experiments, raw silk had furnished the greatest quantity of pure air, or, to express myself more properly, had caused the water to furnish the greatest quantity; but it appeared to me very probable that some other body might be found that possessed this property in a still greater degree than silk. Turning this matter in my mind, it occurred to me to make the experiment with the silky, or rather cotton-like, substance produced by a certain species of the poplar-tree, *Populus nigra*, very com-

mon in this country (Bavaria), and which, I believe, grows in England. I recollected that, examining it some time before, with a different view (that of seeing if it might not be made use of with advantage as a substitute for eider-down), and endeavouring to render it very dry by exposing it in a china plate over a chafing-dish of hot embers, when it had acquired a certain degree of heat, small parcels of it quitted the plate of their own accord, and mounted up to the top of the room.

This convinced me at the time, not only of its extreme fineness, but also of the strong attraction which subsists between it and the particles of air; and it now occurred to me that these qualities not only render it peculiarly proper as a substitute for eider-down, for confining heat, but likewise are properties of all others the most necessary to its supplying the place of silk in the production of air, by exposing it in water to the action of the sun's rays. I, therefore, lost no time in making the following experiments.

Experiment No. 16.

The large globe (contents, 296 cubic inches) being filled with fresh spring-water, and 120 grains of poplar-cotton, upon the evening of the 9th of June, and being the next day, the 10th of June, exposed to the sun about four hours, upon the morning of the 11th the air produced was removed, and its quantity was found to be $1\frac{3}{4}$ cubic inch. Its quality was very bad, *viz.* $1 a + 1 n = 1.65$, or 35 degrees only better than thoroughly phlogisticated air (azote).

Upon the 11th, 12th, and 13th, 1 cubic inch of air only was produced, and this appeared to be as bad as possible; for, proved with nitrous air, it gave $1 a + 1 n = 2$, or 0.

Upon the 14th, a few air-bubbles only were furnished ; but, notwithstanding these unfavourable appearances, I still continued the experiment, and my patience was amply rewarded ; for the next day, the 15th, the sun being very powerful, and the weather very hot, the water, changing suddenly to a greenish colour, began all at once to give good air in great abundance. In the course of the day, $10\frac{42}{100}$ cubic inches were produced, which, proved with nitrous air, gave $1 a + 3 n = 1.43$, or 257.

June 16th, a very warm, clear day. The globe, exposed in the sun from 8 o'clock in the morning till 5 o'clock in the afternoon, furnished $14\frac{34}{100}$ cubic inches of air, which, proved with nitrous air, gave $1 a + 3 n = 1.34$, or 266.

June 17th, cloudy, with intervals of sunshine. The globe, with about four hours sun, gave $7\frac{34}{100}$ cubic inches of air, of a very eminent quality, viz. $1 a + 4 n = 1.40$, or 360.

The water having by degrees lost its transparency, and having acquired a deep green colour, it broke up this day, and deposited a green sediment ; after which it recovered its transparency, and became almost colourless. It continued, notwithstanding, to furnish air in considerable quantities.

June 18th, being exposed in the sun's rays from 8 o'clock in the morning till 2 o'clock in the afternoon, (when the heavens became overcast,) the globe yielded $6\frac{27}{100}$ cubic inches of air, which, proved with nitrous air, gave $1 a + 4 n = 1.44$, or 356.

June the 19th and 20th. These two days the globe furnished no more than $3\frac{13}{100}$ cubic inches of air, which, proved with nitrous air, gave $1 a + 3 n = 1.06$, or 294 ; after which it ceased totally to furnish air, and the colour

of the water changed to a dead yellowish cast, and the cotton assumed the same hue.

The following are the quantities and qualities of the different parcels of air furnished in the course of this experiment.

	Quantity.	Quality.
Upon the 10th of June	$1\frac{3}{4}$ cubic inches	$1 a + 1 n = 1.65$, or 35
11th, 12th, and 13th	1 . . .	$1 a + 1 n = 2.00$, or 0
14th	0	—————
15th	$10\frac{42}{100}$. . .	$1 a + 3 n = 1.43$, or 257
16th	$14\frac{34}{100}$. . .	$1 a + 3 n = 1.34$, or 266
17th	$7\frac{34}{100}$. . .	$1 a + 4 n = 1.40$, or 360
18th	$6\frac{27}{100}$. . .	$1 a + 4 n = 1.44$, or 356
19th and 20th	$3\frac{13}{100}$. . .	$1 a + 3 n = 1.06$, or 294
Total quantity	$44\frac{1}{4}$	Mean qual. $1 a + 3 n = 1.23$, or 277

This experiment was repeated, and with nearly the same result; the total quantity of air produced being $41\frac{1}{8}$ cubic inches, and its quality, at a medium, $1 a + 3 n = 1.26$, or 274.

To ascertain the relative fineness of this poplar cotton and the thread of raw silk as spun by the worm, in order to make an estimate of the surface of the former, I examined them both at the same time under an excellent microscope, when the diameter of the cotton, that is to say, of a single thread or fibre of it, appeared to be not more than half as great as the diameter of the silk, consequently its diameter was not more than $\frac{1}{3}\frac{1}{6}\frac{1}{4}\frac{1}{8}$ part of an inch; for I have found by experiment that the diameter of a thread of silk, as spun by the worm, is only $\frac{1}{8}\frac{1}{2}\frac{1}{4}$ of an inch.

The specific gravity of the cotton I found to be very nearly equal to that of water, consequently it is to that of silk as 1000 to 1734; its surface, therefore, is to the surface of an equal weight of raw silk in the compound

proportion of 2 to 1, and of 1734 to 1000; that is to say, as 3468 to 1000.

Now, as the surface of 30 grains of raw silk amounts to 476 square inches, the surface of 30 grains of poplar cotton must amount to 1651 square inches, which gives 55 square inches of surface for each grain in weight; consequently, the surface of the cotton made use of in the foregoing experiment (No. 16) did not amount to less than 6600 square inches (for 120 grains, the weight of the cotton, multiplied by 55, gives 6600), — an enormous surface indeed for a body whose *solid contents* did not amount to quite half a cubic inch.

From hence it appears evidently, that the quantities of air furnished by water, in the experiments with raw silk and with poplar cotton, were neither in proportion to the quantities of these substances made use of, nor to the quantities of their surfaces. It appears, likewise, from the two last experiments, that the air which is furnished in the beginning of the experiment, or when the water is first exposed to the action of the sun's rays, is neither so good, nor in so great abundance, as afterwards, at a more advanced period; and that it totally ceases to be produced after a certain time.

To ascertain, with greater precision, the qualities of the air furnished at different periods of the experiment, or rather the period when the water begins to give good air; and also to determine the relative quantities and qualities of the airs produced in the experiments with raw silk and in those with poplar cotton, I made the following experiments.

Experiment No. 17.

A globe, about $4\frac{1}{2}$ inches in diameter, containing just

46 cubic inches, being filled in the evening with fresh spring-water, and 30 grains of raw silk, which had been previously washed thoroughly to free it of air and the remains of former experiments, and being exposed the next day in my window, the weather being cold and cloudy, with not more than one hour of sunshine, $\frac{1}{4}$ of a cubic inch of air was produced, which, proved with nitrous air, gave $1 a + 2 n = 1.86$, or 114.

The two following days, the weather being clear and moderately warm, $3\frac{1}{4}$ cubic inches of air were produced, which, proved with nitrous air, gave $1 a + 3 n = 1.14$, or 296.

Experiment No. 18.

The globe having been again filled with fresh spring-water, and the same silk which had served in the last experiment, after 2 nights and 1 day of about 4 hours sun, it had furnished $1\frac{1}{8}$ cubic inch of air, whose quality was $1 a + 2 n = 1.13$, or 197.

The two following days, the weather being very fine, it furnished $3\frac{8}{10}$ cubic inches of air, which, proved with nitrous air, gave $1 a + 4 n = 1.58$, or 342.

Experiment No. 19.

The globe being again filled with fresh water, and the same silk well washed, and being exposed two days in the sun, it gave $2\frac{2}{10}$ cubic inches of air, which, proved with nitrous air, gave $1 a + 3 n = 1.67$, or 233.

Experiment No. 20.

A like globe with fresh water, and an equal quantity of poplar cotton which had been used in former experiments, being exposed at the same time (*viz.* when the

last experiment was made), gave $2\frac{53}{100}$ cubic inches of air, whose quality was $1 a + 3 n = 1.20$, or 280.

Experiment No. 21.

A small globe (contents, 20 cubic inches), with 17 grains of raw silk, exposed at the same time, give 1 cubic inch of air, which turned out $1 a + 3 n = 1.37$, or 263.

Experiment No. 22.

A large globe, containing 296 cubic inches, being filled with fresh water and a small quantity of *conferva rivularis*, and exposed at the same time with the three globes above mentioned, gave $1\frac{1}{2}$ cubic inch of air, which, proved with nitrous air, gave $1 a + 2 n = 1.76$, or 124.

The water, in this experiment, was changed to a brown colour, owing, as I conceived, to the too great heat the *conferva* acquired in the sun.

These experiments were made between the 2d and the 5th of July (1786).

Experiment No. 23.

Surprised at the smallness of the quantity, and the inferior quality, of the air produced in the last experiment, I was induced to repeat it; accordingly, the globe being again filled with water and a quantity of fresh *conferva rivularis* (a small handful), and being exposed to the action of the sun's rays during 3 fine days, $13\frac{34}{100}$ cubic inches of air were produced, which, proved with nitrous air, gave $1 a + 3 n = 1.54$, or 246.

At the end of the experiment, the water appeared to be very faintly tinged of a greenish cast.

The two following experiments were made upon the 20th and 21st of August.

Experiment No. 24.

A globe about $4\frac{1}{2}$ inches in diameter (contents, 46 cubic inches) being filled with fresh spring-water, and 30 grains of raw silk, which had been used in many preceding experiments, and being exposed to the action of the sun's rays two days, in all about 8 hours of sunshine, the weather being cloudy great part of the time, $1\frac{6}{100}$ cubic inch of air was produced, which, proved with nitrous air, gave $1a + 3n = 1.96$, or 204.

Experiment No. 25.

At the same time an equal globe, containing fresh spring-water, and about 15 grains of poplar cotton (which had likewise been used in former experiments), produced $1\frac{28}{100}$ cubic inch of air, which, proved with nitrous air, gave $1a + 3n = 1.40$, or 260.

The water in both these experiments had acquired a faint greenish cast; but the colour of that with the cotton was rather the deepest.

Upon examining this water under a microscope, I found it contained a great number of animalcules exceedingly small, and of nearly a round figure. That with the silk contained them likewise, and of the same kind, but not in so great abundance. I never failed to find them in every case in which the water used in an experiment had acquired a greenish hue; and from their presence alone, I think it more than probable that the colour of the water, *in the first instance*, arose in all cases. I have spent a great deal of time in observing them, and have made many experiments upon their production; but as I have not yet been able to satisfy my own mind, with respect to the part they act in the operation of purifying the air in water, or generating pure air from it, I

shall not add to the length of this paper, by giving an account of my inquiries and observations respecting them.

I was yet by no means satisfied with respect to the part which the silk and other bodies, exposed in water in the foregoing experiments, acted in the generation of the air produced.

Dr. Priestley has long since discovered that many animal and vegetable substances, putrefying, or rather dissolving, in water in the sun, cause the water to yield large quantities of dephlogisticated air; but I could hardly conceive that the small quantity of silk which was used in my experiments, and which had been constantly in water for more than three months, and had so often been washed, and even boiled in water, should yet retain a power of communicating anything to the large quantities of fresh water in which it was successively placed, — at least, *anything* in sufficient quantities to impregnate those bodies of water, and to cause them to yield the great abundance of air which they produced.

It was still more difficult to account for the pure air produced in the experiments with wool and fur and human hair; especially, as in some of these experiments the water had not sensibly changed colour, nor did it appear to have lost anything of its transparency. It is true, in these cases, the quantities of air produced were very small; but yet its quality was better than that of common air, and considerably superior to that of the air commonly existing in the water, previous to its being exposed to the action of the sun's light. In short, it was dephlogisticated in the experiment; but the *manner* in which this was done is very difficult to ascertain.

With a view to throwing some new light upon this intricate subject, I made the following experiments.

Experiment No. 26.

Concluding that if silk and other bodies, used in the foregoing experiments, actually did not contribute anything *considered as chemical substances*, in the process of the production of pure air yielded by water ; but if, on the contrary, they acted merely as a mechanical aid, in the *separation* of the air from the water, by affording a convenient surface for the air to attach itself to, — in this case, any other body having a large surface, and attracting air in water, might be made use of instead of silk in the experiment, and pure air would be furnished, though the body so made use of should be totally incapable of communicating *anything whatever* to the water.

To ascertain this fact, washing the great globe (containing 296 cubic inches) perfectly clean, and filling it with fresh spring-water, I introduced into it a quantity of the fine flexible thread of glass, commonly called *spun glass*, such as is used for making brushes for cleaning jewels, and for making a kind of artificial feather frequently sold by the Jew pedlars. This spun glass is no other than common glass drawn out, when hot, into an exceeding fine thread ; which thread, in consequence of its extreme fineness, retains its flexibility after it has grown cold.

I made choice of this substance, not only on account of its great surface, but also on account of the strong attraction which is known to subsist between glass and air, and the impossibility of its communicating anything to the water.

The result of the experiment was, that, the globe being exposed in the sun, air-bubbles began almost immediately to make their appearance upon the surface of the spun glass, and in four hours $\frac{7}{100}$ of a cubic inch of

air was collected, which, proved with nitrous air, gave $1a + 1n = 1.12$, or 88; after which, not a single air-bubble more was produced, though the globe was exposed a whole week in the window, during which time there were several very warm, fine, sunshiny days.

This experiment shews evidently that something more is wanting to the production of pure air by water, exposed in the sun, than merely a surface to which the air dissolved in the water can attach itself in order to its making its escape.

The air furnished in this experiment was doubtless merely that with which the water, issuing from the earth, was overcharged, and which would have made its escape from the water, had the water, instead of being exposed with the spun glass in the sun, been simply left for some time exposed to the free air of the atmosphere.

It appears that this air, naturally existing in spring-water, instead of being dephlogisticated, is something worse than common air; and this agrees with the observations of Dr. Priestley, and seems to justify his opinion with respect to the cause of the fertility of lands washed by waters issuing from the earth.

If the above experiment shews that something is wanting to be mixed with water in order to enable it to yield pure air, when exposed to the action of the sun's light, the following shew that this *something*, whatever it may be, is frequently to be found in the water itself in its natural state.

Experiment No. 27.

A large jar of clear white glass containing 455 cubic inches, being washed very clean, was filled with fresh spring-water, and inverted in a glass bason of the same,

and placed in the middle of the garden of the Elector's palace at Munich, where it was left exposed to the weather 28 days.

At the same time another like jar was filled with water taken from a pond in the garden, in which many aquatic plants were growing, and was exposed in the same place, and during the same period. This water had a very faint greenish cast. The pond from which it was taken is fed by a large river (the Isar) which runs by the town.

The second day after these waters had been exposed in the sun, I observed that a small quantity of air had collected itself at the upper part of each of the jars.

The third, fourth, and fifth days, the pond-water furnished air in pretty large quantities; and it went on to yield it without intermission, when the sun shone upon it, till the fourteenth day, when it seemed to be nearly exhausted. I continued the experiment, however, till the twenty-eighth day, though, during the last fortnight, the quantity of air in the jar did not appear to be sensibly increased.

The spring-water, during the first five or six days, furnished very little air; and it was not till the fourteenth day that it began to yield it in any considerable quantities. From this time it went on to furnish it, though but very slowly, till about the twenty-second day, when it ceased, appearing to be quite exhausted.

Upon the twenty-eighth day I removed the airs from the jars, when I found their quantities and qualities to be as follows:—

	Quantity.	Quality.
Air furnished by the spring-water	14 cubic in.	$1a + 2n = 1.62$, or 13^8
“ “ “ “ pond “	$31\frac{1}{2}$ “	$1a + 3n = 1.48$, or 25^2

Neither the colour of the spring-water, nor that of the pond-water, appeared to be sensibly changed; but both the one and the other of these waters had deposited a considerable quantity of earth, which was found adhering to the surfaces of the glass basons in which the jars were inverted.

As these basons were rather deep, and as they were very thick in glass, and consequently not very transparent, their bottoms, where the sediment of the water was collected, were, in a great measure, obscured, or deprived of the direct rays of the sun. Suspecting that this circumstance might have had some effect, so as to have hindered the water from furnishing so much air as otherwise it might have yielded, — to satisfy myself respecting this matter, I repeated the experiment, disposing the apparatus in such a manner that the sediment of the water which attached itself to the bottom of the vessel in which the jar was inverted had the advantage of being perfectly illuminated.

Experiment No. 28.

In a large cylindrical jar, of very fine transparent glass, 10 inches in diameter, and 12 inches high, filled with spring-water, I inverted a conical glass jar, $9\frac{3}{4}$ inches in diameter at the bottom, and containing 344 cubic inches, filled with the same water; and exposed the whole 21 days in a window fronting the south.

The quantity of air produced amounted to 40 cubic inches; and its quality, proved by the test of nitrous air, gave $1 a + 3 n = 1.87$, or 213.

The water, in this experiment, furnished very little air till the seventh day; but after that time, having assumed a faint greenish cast, and a fine greenish slimy

sediment (the *green matter* of Dr. Priestley) beginning to be found upon the bottom of the jar, it began to yield air in abundance, and continued to furnish it in pretty large quantities till about the eighteenth day, when it appeared to be exhausted.

Why the water should turn green in this experiment, and not in the last, I know not ; unless it was in consequence of the large surface of water in the cylindrical jar which was exposed to the air in this experiment ; or in consequence of the sun's shining directly upon the bottom of the vessel where the sediment was formed.

In the former experiment, the bason in which the jar was inverted was but just big enough to admit the jar ; and as the jar was cylindrical, the surface of the water exposed to the atmosphere in the bason was but very small ; and the bason being very thick, and formed of glass which, though of the white kind, was of an inferior quality, and very imperfectly transparent, as I have already observed, the bottom of the bason where the sediment was formed was but very imperfectly illuminated.

Having never been thoroughly satisfied with respect to the origin of the dephlogisticated air produced upon exposing fresh vegetables in water to the action of the sun's rays, according to the method of Dr. Ingen-Housz, my doubts with respect to the opinion generally entertained, of its being *elaborated* in the vessels of the plant, instead of being removed, were rather confirmed by the result of these experiments ; and however disposed I was to adopt the beautiful theory of the purification of the atmosphere by the vegetable kingdom, I was not willing to admit a fact which has been brought in support of it, till it should appear to me to have been proved by the most decisive experiments.

That the fresh leaves of certain vegetables, exposed in water to the action of the sun's rays, cause a certain quantity of pure air to be produced, is a fact which has been put beyond all doubt; but it does not appear to me to be by any means so clearly proved, that this air is "*elaborated* in the plant by the powers of vegetation"; — "phlogisticated or fixed air being first absorbed, or imbibed by the plant as food, and the dephlogisticated air being rejected as an excrement": for, besides that many other substances, and in which no elaboration, or circulation, can possibly be suspected to take place, cause the water in which they are exposed to the action of light to yield dephlogisticated air as well as plants, and even in much greater quantities, and of a more eminent quality, the circumstances of the leaves of a vegetable which, accustomed to grow in air, are separated from its stem, and confined in water, are so unnatural that I cannot conceive that they can perform the same functions in such different situations.

Among many facts which have been brought in support of the received opinion of the *elaboration* of the air in the vessels of the plants in the experiments in question, there is one upon which great stress has been laid, which, I think, requires further examination.

The fresh, healthy leaves of vegetables, separated from the plant, and exposed in water to the action of the sun's rays, appear, by all the experiments which have hitherto been made, to furnish air *only for a short time*; after a day or two, the leaves, changing colour, cease to yield air; and this has been conceived to arise from the powers of vegetation being destroyed; or, in other words, *the death of the plant*; and from hence it has been inferred, with some degree of plausibility, not only that the leaves

actually retained their vegetative powers for some time after they were separated from their stock, but also that it was in consequence of the exertion of these powers that the air yielded in the experiment was produced.

But I have found, that though the leaves, exposed in water to the action of light, actually do cease to furnish air after a certain time, yet that they *regain* this power after a short interval, when they furnish (or rather cause the water to furnish) more and better air than at first, which can hardly be accounted for upon the supposition that the air is *elaborated* in the vessels of the plant.

Experiment No. 29.

A globe containing 46 cubic inches, filled with fresh spring-water and two peach-leaves, was exposed in the window to the action of the sun's rays 10 days successively (the weather being in general fine), when the following appearances took place: —

The 1st and 2d day a certain quantity of air was produced, about as much as in former like experiments. The 3d day very little was produced; and the 4th day none at all, the globe to all appearance being quite exhausted. Continuing the experiment, however, upon the 5th day, the water having acquired a faint greenish hue, air was again produced pretty plentifully, *making its appearance upon the surface of the leaves in the form of air-bubbles, as at the beginning of the experiment*; at the end of the 6th day the air was removed, and it was found to amount to $\frac{5.4}{100}$ of a cubic inch, its quality being 232 degrees, or $1 a + 3 n = 1.68$.

Upon the 7th day $\frac{9}{10}$ of a cubic inch of air was produced of 297 degrees, or $1 a + 3 n = 1.03$; and,

During the 8th, 9th, and 10th days, $1\frac{3}{4}$ cubic inch of

air, of 307 degrees (or $1 a + 4 n = 1.93$), was furnished ; after which an end was put to the experiment.

Total quantity of air produced, $3\frac{19}{100}$ cubic inches ; mean quality, 291 degrees, or $1 a + 3 n = 1.09$.

Finding that *leaves which were dead*, or in which all the powers of vegetation were evidently destroyed, continued, notwithstanding, to separate air from water, and that in so great abundance, I was desirous of seeing the effect of exposing fresh, healthy leaves in water which I knew to be previously saturated with, and disposed to yield, dephlogisticated air. I conceived that if the plants exposed in water actually imbibed fixed or phlogisticated air as food, and after digesting it, “ discharged the dephlogisticated air as an excrement ” ; in that case, as there is no instance of any plant or animal being able to nourish itself with its own excrement, the leaves exposed in water saturated with dephlogisticated air, instead of imbibing and elaborating it, would immediately die.

The experiments which I made to ascertain this fact, and which, without any comment, I shall submit to the consideration of the reader, were as follows.

Experiment No. 30.

Having provided a quantity of water, which, by being exposed with a few green leaves in the sun, had acquired a greenish cast, and which I found was disposed to yield dephlogisticated air in great abundance, I filled a globe, containing 46 cubic inches, with this water, and putting to it two healthy peach-leaves, exposed the globe in the sun upon the 7th of September, from 11 o'clock in the morning till 2 o'clock in the afternoon (3 hours), when $\frac{7}{10}$ of a cubic inch of air was produced, which, proved with nitrous air, gave $1 a + 3 n = 1.52$, or 248 degrees.

A like globe, with fresh spring-water and two peach-leaves, exposed at the same time, furnished only $\frac{1}{9}$ of a cubic inch of air, which, on account of the smallness of its quantity, I did not submit to the test of nitrous air.

Experiment No. 31.

September 8. Very fine clear weather, but rather cold for the season. Three equal globes, A, B, and C, containing each 46 cubic inches, were filled as follows, and exposed in the sun from 9 o'clock in the morning till half an hour past 4 in the afternoon, when they were found to have produced air as under mentioned.

The globe A, filled with water, which, by being previously exposed in the sun for several days, with potatoes cut in thin slices, had turned green, furnished $\frac{9}{10}$ of a cubic inch of air of 299 degrees, or $1 a + 3 n = 1.01$. N. B. This water, before it was put into the globe, was strained through two thicknesses of very fine Irish linen.

The globe B, filled with the same green potatoe-water (strained as before), to which were added four middling-sized peach-leaves, furnished $2\frac{1}{2}$ cubic inches of air of 320 degrees, or $1 a + 4 n = 1.80$.

The globe C, filled with *fresh spring-water*, with four peach-leaves, furnished $\frac{5.2}{100}$ of a cubic inch of air of 151 degrees, or which, proved with nitrous air, gave $1 a + 2 n = 1.49$.

To ascertain the quantities and qualities of the airs remaining in the different waters used in this experiment, putting the globes separately over a chafing-dish of live coals, and making the water boil, taking care to hold the globe in such an inclined position as that the air separated from the water might be collected in the upper part of the globe, the airs produced were as follows : —

	Quantity.	Quality.
By the green water in the globe A,	$\frac{85}{100}$ of a cubic inch	280 degrees
“ “ “ “ “ B,	$\frac{31}{100}$ “ “	241 “
By the spring-water in the globe C,	$\frac{11}{100}$ “ “	68 “

The waters in these experiments were made to boil but for a moment ; ocherwise it is probable more air might have been separated from them.

Finding that fresh leaves, exposed to the action of the sun's rays, in water which had already turned green, caused pure air to be separated from the water in so great abundance, I repeated the experiment, — only, instead of leaves, I now made use of a small quantity of *conferva rivularis*; when I had nearly the same result as with the leaves.

To ascertain the relative quantities and qualities of the airs yielded by the green water, when exposed with fresh leaves, and when exposed with raw silk ; and also to ascertain, at the same time, how long, leaves, exposed in green water, retain their power of separating air from it, I made

Experiment No. 32.

Two equal globes, A and B (containing each 46 cubic inches), the former (A) filled with green potatoe-water, strained through linen, and four peach-leaves ; the latter (B) filled with the same potatoe-water, strained in like manner, and 17 grains of raw silk, — were exposed from Sunday noon, September 10th, till Monday evening ; the weather being cold, with many flying clouds, in all about 6 or 7 hours sun.

The airs produced were as follows : —

By the globe A, with green water } and 4 peach-leaves }	Quantity. $2\frac{7}{10}$ cubic inches	Quality. 292 degrees.
By the globe B, with green water } and 17 grs. of raw silk . . . }	$2\frac{7}{10}$ “ “	307 “

Another globe (C), filled with green water *alone*, was exposed at the same time ; but it was broken by an accident before the experiment was completed.

The two globes (A and B), with their contents, being again exposed from Tuesday noon till Thursday evening, yielded air as follows : —

	Quantity.	Quality.
The globe A, with the peach-leaves	41 $\frac{47}{100}$ cubic inches	344 degrees.
The globe B, with raw silk . . .	41 $\frac{3}{10}$ “ “	350 “

N. B. The weather on Tuesday and Wednesday was cold, with very little sunshine ; but Thursday was a very fine, warm day, when the greatest part of the air was produced. This air was removed, and proved on Friday morning, the 15th September.

Perhaps all the appearances above described might be satisfactorily accounted for, by supposing the air produced in the different experiments to have been generated in the mass of water by the *green matter*, and that the leaves, the silk, &c. did no more than *assist it in making its escape* by affording it a convenient surface, to which it could attach itself, in order to its collecting itself together, and taking upon itself its elastic form.

The phænomena might likewise be accounted for, by supposing the *green matter* to be a vegetable substance agreeable to the hypothesis of Dr. Priestley, and that attaching itself to the surfaces of the bodies exposed in the water, as a plant is attached to its soil, it grows ; and in consequence of the exertion of its vegetative powers, the air yielded in the experiment is produced.

I should most readily have adopted this opinion, had not a careful and attentive examination of the green water, under a most excellent microscope, at the time when it appeared to be most disposed to yield pure air

in abundance, convinced me that, *at that period*, it contains nothing that can possibly be supposed to be of a vegetable nature. The colouring matter of the water is evidently of an animal nature, being nothing more than the assemblage of an infinite number of very small, active, oval-formed animalcules, without anything resembling *tremella*, or that kind of *green matter*, or water moss, which grows upon the bottom and sides of the vessel when this water is suffered to remain in it for a considerable time, and into which Dr. Ingen-Housz supposes the animalcules above mentioned to be actually transformed.

But having finished the account of my experiments, I shall finish this paper, not daring to venture conjectures upon a subject so intricate in itself and so new, and upon which the ablest philosophers of the age seem to be so much divided in opinion.

AN ACCOUNT
OF SOME
EXPERIMENTS

MADE

TO DETERMINE THE QUANTITIES OF MOISTURE ABSORBED
FROM THE ATMOSPHERE BY VARIOUS SUBSTANCES.

BEING engaged in a course of experiments upon the conducting powers of various bodies with respect to heat, and particularly of such substances as are commonly made use of for cloathing, in order to see if I could discover any relation between the conducting powers of those substances and their power of absorbing moisture from the atmosphere, I made the following experiments.

Having provided a quantity of each of the under-mentioned substances, in a state of the most perfect cleanness and purity, I exposed them, spread out upon clean china plates, twenty-four hours in the dry air of a very warm room (which had been heated every day for several months by a German stove), the last six hours the heat being kept up to 85° of Fahrenheit's thermometer; after which I entered the room with a very accurate balance, and weighed equal quantities of these various substances, as expressed in the following table.

This being done, and each substance being equally spread out upon a very clean china plate, they were removed into a very large uninhabited room upon the second floor, where they were exposed 48 hours upon a table placed in the middle of the room, the air of the

room being at the temperature of 45° F.; after which they were carefully weighed (in the room), and were found to weigh as under mentioned.

They were then removed into a very damp cellar, and placed upon a table in the middle of a vault, where the air, which appeared by the hygrometer to be completely saturated with moisture, was at the temperature of 45° F.; and in this situation they were suffered to remain three days and three nights, the vault being hung round, during all this time, with wet linen cloths, to render the air as damp as possible, and the door of the vault being shut.

At the end of the three days I entered the vault with the balance, and weighed the various substances upon the spot, when they were found to weigh as is expressed in the third column of the following table: —

The various Substances.	Weight after being dried 24 hours in a hot room.	Weight after being exposed 48 hours in a cold uninhabited room.	Weight after being exposed 72 hours in a damp cellar.
	Pts.	Pts.	Pts.
Sheep's wool	1000	1084	1163
Beaver's fur	1000	1072	1125
The fur of a Russian hare	1000	1065	1115
Eider-down	1000	1067	1112
Silk { Raw, single thread	1000	1057	1107
{ Ravelings of white taffety	1000	1054	1103
Linen { Fine lint	1000	1046	1102
{ Ravelings of fine linen	1000	1044	1082
Cotton-wool	1000	1043	1089
Silver wire, very fine, gilt, and flatted, being the ravel- ings of gold lace	1000	1000	1000

N. B. The weight made use of in these experiments was that of Cologne, the *parts*, or least divisions, being $= \frac{1}{85\frac{1}{3}\frac{1}{8}}$ part of a mark; consequently 1000 of these *parts* make about $52\frac{3}{4}$ grains Troy.

I did not add the silver wire to the bodies above mentioned, from any idea that that substance could possibly imbibe moisture from the atmosphere; but I was willing to see whether a metal, placed in air saturated with water, is not capable of receiving a small addition of weight from the moisture attracted by it, and attached to its surface; from the result of the experiment, however, it should seem that no such attraction subsists between the metal I made use of, and the watery vapour dissolved in air.

I was totally mistaken in my conjectures relative to the results of the experiments with the other substances. As linen is known to attract water with so much avidity; and as, on the contrary, wool, hair, feathers, and other like animal substances are made wet with so much difficulty, I had little doubt but that linen would be found to attract moisture from the atmosphere with much greater force than any of those substances; and that, under similar circumstances, it would be found to contain much more water; and I was much confirmed in this opinion upon recollecting the great difference in the apparent dampness of linen and of woollen clothes, when they are both exposed to the same atmosphere. But these experiments have convinced me that all my speculations were founded upon erroneous principles.

It should seem that those bodies which are the most easily wetted, or which receive water, in its unelastic form, with the greatest ease, are not those which in all cases attract the watery vapour dissolved in the air with the greatest force.

Perhaps the apparent dampness of linen to the touch arises more from the ease with which that substance parts with the water it contains than from the quantity of water it actually holds; in the same manner as a body

appears hot to the touch, in consequence of its parting freely with its heat, while another body, which is actually at the same temperature, but which withholds its heat with greater obstinacy, affects the sense of feeling much less violently.

It is well known that woollen clothes, such as flannels, &c., worn next the skin, greatly promote insensible perspiration. May not this arise principally from the strong attraction which subsists between wool and the watery vapour which is continually issuing from the human body?

That it does not depend entirely upon the warmth of that covering is evident; for the same degree of warmth, produced by wearing more cloathing of a different kind, does not produce the same effect.

The perspiration of the human body being absorbed by a covering of flannel, it is immediately distributed through the whole thickness of that substance, and by that means exposed by a very large surface to be carried off by the atmosphere; and the loss of this watery vapour, which the flannel sustains on the one side, by evaporation, being immediately restored from the other, in consequence of the strong attraction between the flannel and this vapour, the pores of the skin are disencumbered, and they are continually surrounded by a dry, warm, and salubrious atmosphere.

I am astonished that the custom of wearing flannel next the skin should not have prevailed more universally. I am confident it would prevent a multitude of diseases; and I know of no greater luxury than the comfortable sensation which arises from wearing it, especially after one is a little accustomed to it.

It is a mistaken notion that it is too warm a cloathing for summer. I have worn it in the hottest climates, and

in all seasons of the year, and never found the least inconvenience from it. It is the warm bath of a perspiration confined by a linen shirt, wet with sweat, which renders the summer heats of the tropical climates so insupportable; but flannel promotes perspiration, and favours its evaporation; and evaporation, as is well known, produces positive cold.

I first began to wear flannel, not from any knowledge which I had of its properties, but merely upon the recommendation of a very able physician (Sir Richard Jebb); and when I began the experiments of which I have here given an account, I little thought of discovering the physical cause of the good effects which I had experienced from it; nor had I the most distant idea of mentioning the circumstance. I shall be happy, however, if what I have said or done upon the subject should induce others to make a trial of what I have so long experienced with the greatest advantage, and which, I am confident, they will find to contribute greatly to health, and consequently to all the other comforts and enjoyments of life.

I shall then think these experiments, trifling as they may appear, by far the most fortunate and the most important ones I have ever made.

With regard to the original object of these experiments, the discovery of the relation which I thought might possibly subsist between the warmth of the substances in question, when made use of as cloathing, and their powers of attracting moisture from the atmosphere; or, in other words, between the quantities of water they contain, and their conducting powers with regard to heat, I could not find that these properties depended in any manner upon, or were in any way connected with, each other.

THE PROPAGATION OF HEAT
IN FLUIDS.

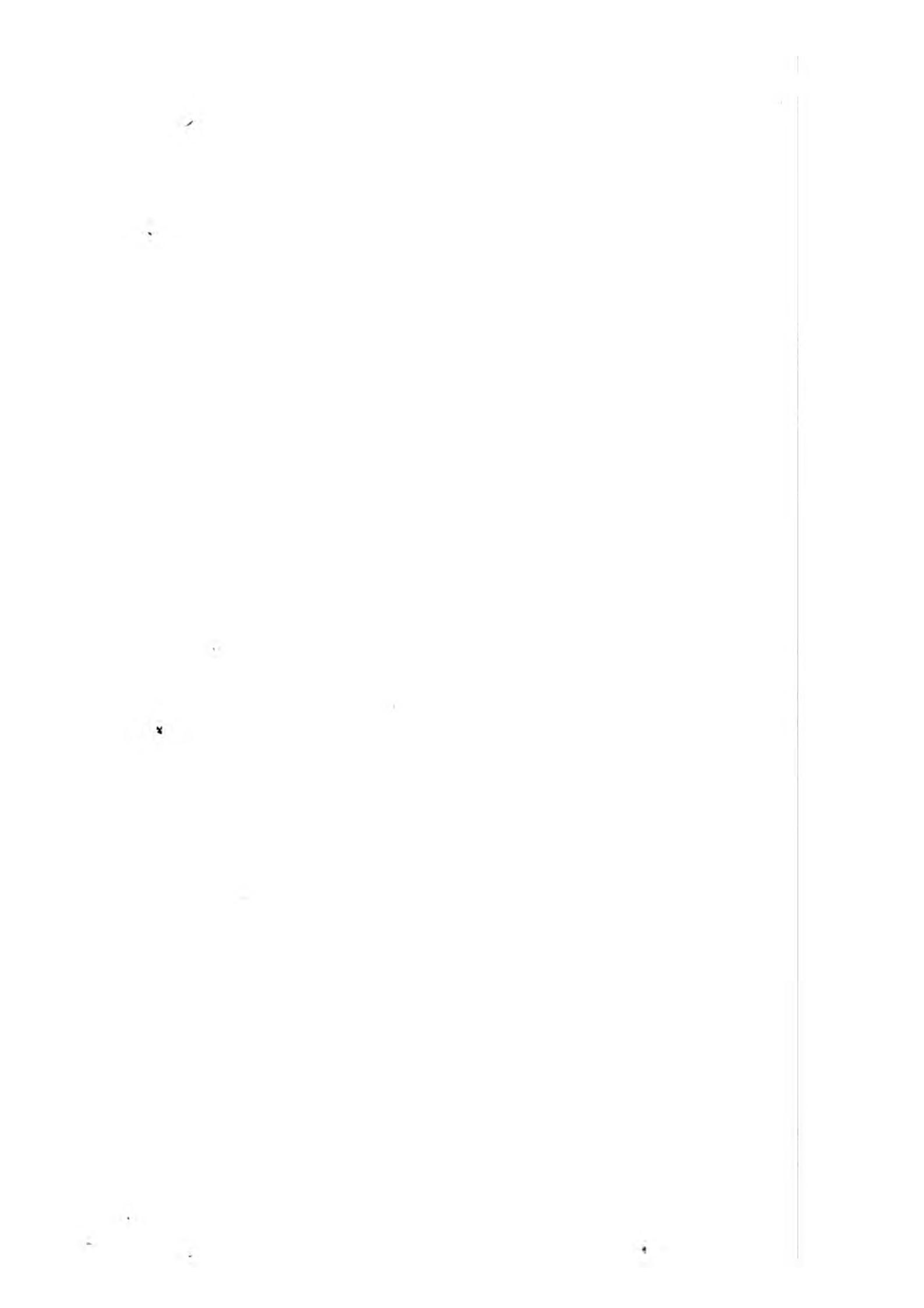

PART I.

OF A REMARKABLE LAW

WHICH HAS BEEN FOUND TO OBTAIN IN THE CONDENSATION OF WATER WITH COLD, WHEN IT IS NEAR THE TEMPERATURE AT WHICH IT FREEZES; AND OF THE WONDERFUL EFFECTS WHICH ARE PRODUCED BY THE OPERATION OF THAT LAW IN THE ECONOMY OF NATURE.

TOGETHER WITH

CONJECTURES

RESPECTING THE FINAL CAUSE OF THE SALTNESS OF THE SEA.

CHAPTER I.

Danger of admitting received Opinions in Philosophical Investigations without Examination. — The free Passage of HEAT, in all Bodies, in all Directions, never yet called in Question. — Heat does not, however, pass in this Manner in all Bodies without Exception. — AIR and WATER, and probably all other FLUIDS, are, in fact, NON-CONDUCTORS OF HEAT. — Accidental Discoveries which led to an experimental Investigation of this curious Subject. — The internal Motions among the Particles of Fluids rendered visible. — The Propagation of Heat in Fluids obstructed and retarded by everything which obstructs the internal Motions of their Particles; hence there is Reason to conclude that Heat is propagated in them only in Consequence of those Motions, — that it is transported by them, not suffered to pass through them. — FURS and FEATHERS, and all other like Substances, which, in Air, form warm Covering for confining Heat, found, by Experiment, to produce the

same Effects in Water. — These Effects are probably produced in both Fluids in the same Manner, namely, by obstructing the Motions of their Particles in the Operation of transporting the Heat. — The conducting Power of Water remarkably impaired by mixing with it such Substances as render it viscous and diminish its Fluidity. — These Discoveries respecting the Manner in which Heat is propagated in Water throw much Light on several of the most interesting Operations in the Economy of Nature. — They enable us to account in a satisfactory Manner for the Preservation of Trees and other Vegetables, and of Fruits, during the Winter, in cold Climates.

IT is certain that there is nothing more dangerous in philosophical investigations, than to take anything for granted, however unquestionable it may appear, till it has been proved by direct and decisive experiment.

I have very often, in the course of my philosophical researches, had occasion to lament the consequences of my inattention to this most necessary precaution.

There is not, perhaps, any phenomenon that more frequently falls under our observation than the Propagation of Heat. The changes of the temperature of sensible bodies, of solids, liquids, and elastic fluids, are going on perpetually under our eyes, and there is no fact which one would not as soon think of calling in question as to doubt of the free passage of Heat, in all directions, through all kinds of bodies. But, however obviously this conclusion appears to flow from all that we observe and experience in the common course of life, yet it is certainly not true ; and to the erroneous opinion respecting this matter, which has been universally entertained by the *learned* and by the *unlearned*, and which has, I be-

lieve, never even been called in question, may be attributed the little progress that has been made in the investigation of the science of Heat, — a science, assuredly, of the utmost importance to mankind!

Under the influence of this opinion I, many years ago, began my experiments on Heat; and had not an accidental discovery drawn my attention with irresistible force and fixed it on the subject, I probably never should have entertained a doubt of the free passage of Heat *through air*; and even after I had found reason to conclude, from the results of experiments which to me appeared to be perfectly decisive, that air is a *non-conductor* of Heat, or that Heat cannot pass through it without being transported by its particles, which, in this process, act individually or independently of each other; yet, so far from pursuing the subject and contriving experiments to ascertain the manner in which Heat is communicated in other bodies, I was not sufficiently awakened to suspect it to be even possible that this quality could extend farther than to elastic Fluids.

With regard to liquids, so entirely persuaded was I that Heat could pass freely *in them* in all directions, that I was perfectly blinded by this prepossession, and rendered incapable of seeing the most striking and most evident proofs of the fallacy of this opinion.

I have already given an account, in one of my late publications (Essay on the Management of Fire and the Economy of Fuel), of the manner in which I was led to discover that *steam* and *flame* are *non-conductors* of Heat. I shall now lay before the public an account of a number of experiments I have lately made, which seem to show that *water*, and probably all other liquids, and Fluids of every kind, possess the same property. That

is to say, that, although the particles of any Fluid, *individually*, can receive Heat from other bodies or communicate it to them, yet among these particles themselves all *interchange* and *communication* of Heat is absolutely impossible.

It may, perhaps, be thought not altogether uninteresting to be acquainted with the various steps by which I was led to an experimental investigation of this curious subject of enquiry.

When dining, I had often observed that some particular dishes retained their Heat much longer than others, and that apple-pies, and apples and almonds mixed (a dish in great repute in England), remained hot a surprising length of time.

Much struck with this extraordinary quality of retaining Heat which apples appeared to possess, it frequently occurred to my recollection; and I never burnt my mouth with them, or saw others meet with the same misfortune, without endeavouring, but in vain, to find out some way of accounting in a satisfactory manner for this surprising phenomenon.

About four years ago, a similar accident awakened my attention, and excited my curiosity still more: being engaged in an experiment which I could not leave, in a room heated by an iron stove, my dinner, which consisted of a bowl of thick rice-soup, was brought into the room, and as I happened to be too much engaged at the time to eat it, in order that it might not grow cold, I ordered it to be set down on the top of the stove; about an hour afterwards, as near as I can remember, beginning to grow hungry, and seeing my dinner standing on the stove, I went up to it and took a spoonful of the soup, which I found almost cold and quite thick. Going, by

accident, deeper with the spoon the second time, this second spoonful burnt my mouth.* This accident recalled very forcibly to my mind the recollection of the hot apples and almonds with which I had so often burned my mouth a dozen years before in England; but even this, though it surprised me very much, was not sufficient to open my eyes, and to remove my prejudices respecting the conducting power of water.

Being at Naples in the beginning of the year 1794, among the many natural curiosities which attracted my attention, I was much struck with several very interesting phænomena which the hot baths of Baiæ presented to my observation, and among them there was one which quite astonished me: standing on the sea-shore near the baths, where the hot steam was issuing out of every crevice of the rocks, and even rising up out of the ground, I had the curiosity to put my hand into the water. As the waves which came in from the sea followed each other without intermission, and broke over the even surface of the beach, I was not surprised to find the water cold; but I was more than surprised, when, on running the ends of my fingers through the cold water into the sand, I found the heat so intolerable that I was obliged instantly to remove my hand. The sand was perfectly wet, and yet the temperature was so very different at the small distance of two or three inches! I could not reconcile this with the supposed great conducting power of water. I even found that the top of the sand was, to all appearance, quite as cold as the water which flowed over it, and this increased my astonishment still more. I then, for the first time, began to doubt of the conduct-

* It is probable that the stove happened to be nearly cold when the bowl was set down upon it, and that the soup had grown almost cold; when a fresh quantity of fuel being put into the stove, the Heat had been suddenly increased.

ing power of water, and resolved to set about making experiments to ascertain the fact. I did not, however, put this resolution into execution till about a month ago, and should perhaps never have done it, had not another unexpected appearance again called my attention to it, and excited afresh all my curiosity.

In the course of a set of experiments on the communication of Heat, in which I had occasion to use thermometers of an uncommon size (their globular bulbs being above four inches in diameter) filled with various kinds of liquids, having exposed one of them, which was filled with spirits of wine, in as great a heat as it was capable of supporting, I placed it in a window, where the sun happened to be shining, to cool; when, casting my eye on its tube, which was quite naked (the divisions of its scale being marked in the glass with a diamond), I observed an appearance which surprised me, and at the same time interested me very much indeed. I saw the whole mass of the liquid in the tube in a most rapid motion, running swiftly in two opposite directions, *up* and *down* at the same time. The bulb of the thermometer, which is of copper, had been made two years before I found leisure to begin my experiments, and having been left unfilled, without being closed with a stopple, some fine particles of dust had found their way into it, and these particles, which were intimately mixed with the spirits of wine, on their being illuminated by the sun's beams, became perfectly visible (as the dust in the air of a darkened room is illuminated and rendered visible by the sunbeams which come in through a hole in the window-shutter), and by their motion discovered the violent motions by which the spirits of wine in the tube of the thermometer was agitated.

This tube, which is $\frac{4\frac{3}{10}}{4}$ of an inch in diameter internally, and very thin, is composed of very transparent, colourless glass, which rendered the appearance clear and distinct and exceedingly beautiful. On examining the motion of the spirits of wine with a lens, I found that the ascending current occupied the *axis of the tube*, and that it descended by the *sides of the tube*.

On inclining the tube a little, the *rising* current moved out of the axis and occupied that side of the tube which was uppermost, while the *descending* current occupied the whole of the lower side of it.

When the cooling of the spirits of wine in the tube was hastened by wetting the tube with ice-cold water, the velocities of both the ascending and the descending currents were sensibly accelerated.

The velocity of these currents was gradually lessened as the thermometer was cooled, and when it had acquired nearly the temperature of the air of the room, the motion ceased entirely.

By wrapping up the bulb of the thermometer in furs, or any other warm covering, the motion might be greatly prolonged.

I repeated the experiment with a similar thermometer of equal dimensions, filled with linseed-oil, and the appearances, on setting it in the window to cool, were just the same. The directions of the currents, and the parts they occupied in the tube, were the same, and their motions were to all appearance quite as rapid as those in the thermometer which was filled with spirits of wine.

Having now no longer any doubt with respect to the cause of these appearances, being persuaded that the motion in these liquids was occasioned by their particles *going individually, and in succession*, to give off their Heat

to the cold sides of the tube in the same manner as I have shown in another place that the particles of air give off *their* Heat to other bodies, I was led to conclude that these, and probably all other liquids, are in fact *non-conductors* of Heat, and I went to work immediately to contrive experiments to put the matter out of all doubt.

On considering the subject attentively, it appeared to me that if liquids were in fact *non-conductors* of Heat, or if it be propagated in them *only* in consequence of the internal motions of their particles, in that case everything which tends to obstruct those motions ought certainly to retard the operation, and render the propagation of the Heat slower and more difficult. I had found that this is actually the case in respect to air, and though (under the influence of a strong and deep-rooted prejudice) I had, from the result of one imperfect experiment, too hastily concluded that it did not take place in regard to water, yet I now found strong reasons to call in question the result of that experiment, and to give the subject a careful and thorough investigation.

Thinking that the best mode of proceeding in this enquiry would be to adopt a method similar to that I had pursued in my experiments on the conducting power of Air, I prepared an apparatus suitable to that purpose. The first object I had in view being to discover whether the propagation of Heat through water was obstructed or not, by rendering the internal motion among the particles of the water, occasioned by their change of temperature, embarrassed and difficult, I contrived to make a certain quantity of Heat pass through a certain quantity of pure water confined in a certain space ; and, noting the time employed in this operation, I repeated the experiment again with the same apparatus, with this differ-

ence only, that in this second trial the water through which the Heat was made to pass, instead of being pure, was mixed with a small quantity of some fine substance (such as eider-down, for instance), which, without altering any of its chemical properties, or impairing its fluidity, served merely to obstruct and embarrass the motions of the particles of the water in transporting the Heat, in case Heat should be actually *transported* or *carried* in this manner, and not suffered to pass freely through liquids.

The body which received the Heat, and which served at the same time to measure the quantity of it communicated, was a very large cylindrical thermometer. (See Plate I.) The bulb of this thermometer, which is constructed of thin sheet-copper, is cylindrical, its two ends being hemispheres.

Its dimensions are as follows : —

Dimensions of the bulb of the thermometer.	{	Diameter	1.84 inches.
		Length	4.99 “
		Capacity or contents . .	13.2099 cubic inches.
		External superficies . .	28.834 superficial inches.

The thickness of the sheet-copper of which it is constructed is 0.03 of an inch. It weighs, empty, 1846 grains, and is capable of containing 3344 grains of water at the temperature of 55°. This copper bulb has a glass tube, 24 inches long, and $\frac{4}{10}$ of an inch in diameter, which is fitted by means of a good cork into a cylindrical tube or neck of copper, one inch long, and $\frac{6.5}{100}$ of an inch in diameter, belonging to the metallic bulb.

This thermometer, being filled with linseed-oil and its scale graduated, was fixed in the axis of a hollow cylinder constructed of thin sheet-copper, $11\frac{1}{2}$ inches long, and 2.3435 inches in diameter internally. This cylinder,

which is open at one end, is closed at the other with a hemispherical bottom, with its convex surface outwards. The cylinder weighs 2261 grains, and the sheet-brass, of which it is constructed, is 0.0128 of an inch in thickness.

The bulb of the thermometer was placed in the lower part of this brass cylindrical tube, and was confined in the middle or axis of it by means of three pins of wood, about $\frac{1}{10}$ of an inch in diameter, and $\frac{1}{4}$ of an inch long, which pins are fixed in tubes of thin sheet-brass $\frac{1}{10}$ of an inch in diameter, and $\frac{3}{20}$ of an inch in length. These short tubes, which are placed at proper distances on the inside of the large brass tube at its lower end, and firmly attached to it by solder, serve as sockets into which the ends of the wooden pins are fixed, which, pointing inwards or towards the axis of the large cylindrical tube, serve to confine the lower end of the bulb of the thermometer in its proper place. Its upper end is kept in its place, or the axis of the thermometer is made to coincide with the axis of the brass cylinder, by causing the tube of the thermometer to pass through a hole in the middle of a cork stopper which closes the end of the cylinder.

The bottom of the bulb of the thermometer does not repose on the hemispherical bottom of the brass cylinder, but is supported at the distance of $\frac{1}{4}$ of an inch above it, on the end of a wooden pin, like those just described, which pin is fixed in a socket in the middle of the bottom of the cylindrical tube and projects upwards. The ends of all these wooden pins which project beyond the sockets in which they are fixed are reduced to a blunt point. This was done to reduce as much as possible the points of contact between the ends of these pins and the bulb of the thermometer.

The thermometer being in its place, there is on every side a void space left between the bulb of the thermometer and the internal surface of the brass cylinder in which it is confined, the distance between the external surface of the bulb of the thermometer and the internal surface of the containing cylinder being 0.25175 of an inch. This space is designed to contain the water and other substance through which the Heat is made to pass *into*, or *out of*, the bulb of the thermometer, and the quantity of Heat which has passed is shewn by the height of the fluid in the tube of the thermometer. The quantity of water required to fill this space and to cover the upper end of the bulb of the thermometer to the height of about $\frac{1}{4}$ of an inch was found to weigh 2468 grains. As the thermometer was plunged into this water, it was, of course, in contact with it by its whole surface, which, as we have seen, is equal to 28.834 square inches.

The bulb of the thermometer being surrounded by water, or by any other liquid or mixture, the conducting power of which was to be ascertained, a cylinder of cork something less in diameter than the brass cylinder, about half an inch long, with a hole in its center, in which the tube of the thermometer passed freely, was thrust down into the brass cylinder, but not quite so low as to touch the surface of the water or other substance it contained. This cylinder, or disk, was supported in its proper place by three projecting brass points or pins which were fixed with solder to the outside of the metallic neck of the bulb of the thermometer.

As soon as this disk of cork is put into its place, the upper part of the hollow brass cylindrical tube is filled with eider-down, and it is closed above with its cork stopper, the tube of the thermometer, which passes

through a fit hole in the middle of this stopper, projecting upwards. As the whole scale of the thermometer, from the point of freezing to that of boiling water, is above the upper surface of this stopper, all the changes of Heat to which the instrument is exposed can be observed at all times without deranging any part of the apparatus.

The thermometer is divided according to the scale of Fahrenheit, and its divisions are made to correspond with a very accurate mercurial thermometer made by Troughton.

The experiments with this instrument, which, for the sake of distinction, I shall call my *cylindrical passage thermometer*, were made in the following manner: The thermometer being fixed in its cylindrical brass tube in the manner above described, and surrounded by the substance the conducting power of which was to be ascertained, the instrument was placed in thawing ice, where it was suffered to remain till the thermometer fell to 32°. It was then taken out of the melting ice and immediately plunged into a large vessel of boiling water, and the conducting power of the substance which was the subject of the experiment was estimated by the time employed by the Heat in passing through it into the thermometer; the time being carefully noted when the liquid in the thermometer arrived at the 40th degree of its scale, and also when it came to every 20th degree above it.

As the slower Heat moves, or is transported, in any medium, the longer must of course be the time required for any given quantity of it to pass through it; and as the thermometer shows the changes which take place in the temperature of the body which is heated or cooled (namely, the liquid with which the thermometer is filled),

in consequence of the passage of the Heat through the medium by which the thermometer is surrounded, the conducting power of that medium is shewn by the quickness of the ascent or descent of the thermometer, when, having been previously brought to a certain temperature, the instrument is suddenly removed and plunged into another medium at any other constant given temperature.

Having still fresh in my memory the accidents I had so often met with in eating hot apple-pies, I was very impatient, when I had completed this instrument, to see if apples, which, as I well knew, are composed almost entirely of water, really possess a greater power of retaining Heat than that liquid when it is pure or unmixed with other bodies. But before I made the experiment, in order that its result might be the more satisfactory, I determined in the following manner how much water there really is in apples, and what proportion their fibrous parts bear to their whole volume.

960 grains of stewed apples (the apples having been carefully pared and freed from their stems and seeds before they were stewed) were well washed in a large quantity of cold spring water, and the fibrous parts of the apples being suffered to subside to the bottom of the vessel, the clear part of the liquor was poured off, and the fibrous remainder being thoroughly dried was carefully weighed, and was found to weigh just 25 grains.

This fibrous remainder of the 960 grains of stewed apples being again washed in a fresh quantity of cold spring water, and afterwards very thoroughly dried by being exposed several days on a china plate placed on the top of a German stove, which was kept constantly hot, was again weighed, and was found to weigh no more than $18\frac{9}{16}$ grains.

From this experiment it appears that the fibrous parts of stewed apples amount to less than $\frac{1}{50}$ part of the whole mass, and there is abundant reason to conclude that the remainder, amounting to $\frac{49}{50}$ of the whole, is little else than pure water.

Having surrounded the bulb of my cylindrical passage thermometer with a quantity of these stewed apples (the consistence of the mass being such that it shewed no signs of fluidity), the instrument was placed in pounded ice which was melting, and when the thermometer indicated that the whole was cooled down to the temperature of 32° , the instrument was taken out of the melting ice and plunged into a large vessel of boiling water, and the water being kept boiling with the utmost violence during the whole time the experiment lasted, the times taken up in heating the thermometer from 20 to 20 degrees were observed and noted down in a table which had been previously prepared for that purpose.

This experiment having been repeated twice, and varied as often by first heating the instrument to the temperature of boiling water and then plunging it into melting ice, and observing the time taken up in the passage of the *Heat out* of the thermometer, I removed the stewed apples which surrounded the bulb of the thermometer, and, filling the space they had occupied with *pure water*, I now repeated the experiments again with that liquid. The following tables shew the results of these experiments.

Time the Heat was passing INTO the Thermometer.				
Through Stewed Apples.		Through Water.		
Exp. No. 1.	Exp. No. 3.	Exp. No. 5.	Exp. No. 7.	
Seconds.	Seconds.	Seconds.	Seconds.	
In heating the Thermometer from the temperature of 32° to that of 40	95	89	45	45
from 40° to 60	75	67	36	35
60 to 80	61	56	34	31
100	65	60	30	30
120	73	66	37	36
140	90	82	44	44
160	121	113	63	60
180	188	170	93	90
200	360	364	226	215
Total times in heating from 32° to 200°	1128	1057	608	586
Times employed in heating the instrument 80 degrees, viz. from 80° to 160°	349'	321''	174''	170''
Mean times in heating it from 80° to 160°	In Stewed Apples 335''		In Water 172''	

The results of these experiments shew that Heat passes with much greater difficulty, or much slower, in *stewed apples* than in *pure water*; and as stewed apples are little else than water mixed with a very small proportion of fibrous and mucilaginous matter, this shews that the conducting power of water with regard to Heat *may be impaired*.

The results of the following experiments will serve to confirm this conclusion.

Time the Heat was passing OUT OF the Thermometer.						
		Through Stewed Apples.	Through Water.			
		Exp. No. 2.	Exp. No. 4.	Exp. No. 6.	Exp. No. 8.	
		Seconds.	Seconds.	Seconds.	Seconds.	
In cooling the Thermometer } from the temperature of 200° } to that of 180 } from 180° to 160 } 160 to 140 } 120 } 100 } 80 } 60 } 40 }		80	74	46	37	
		75	72	42	37	
		84	83	43	43	
		107	101	54	51	
		141	136	73	73	
		198	190	112	105	
		321	307	200	204	
		775	733	483	461	
	Total time in cooling from } 200° to 40° }		1781	1696	1053	1011
	Times employed in cooling the } instrument 80 degrees, viz. } from 160° to 80° }		530''	510''	282''	272''
Mean time in cooling it from } 160° to 80° }		In Stewed Apples 520''		In Water 277''		

As the heating or cooling of the instrument goes on very slowly when it approaches to the temperature of the medium in which it is placed, while, on the other hand, this process is very rapid when, the temperature of the instrument being very different from that of the medium, it is first plunged into it, both these circumstances conspire to render the observations made at the extremities of the scale of the thermometer more subject to error, and consequently less satisfactory, than those made nearer the middle of it. In order that the general conclusions drawn from the result of the experiments might not be vitiated by the effects produced by these unavoidable inaccuracies, instead of estimating the celer-

ity of the passage of the Heat by the times elapsed in heating and cooling the thermometer *through the whole length of its scale*, or between the point of freezing to that of boiling water, I have taken the times elapsed in heating and cooling it *80 degrees in the middle of the scale*, viz. between 80° and 160° , as the measure of the conducting powers of the substances through which the Heat was made to pass.

I have, however, noted the times which elapsed in heating and cooling the instrument through a much larger interval, namely, through an interval of 168 degrees in *heating*, or from 32° to 200° , and in *cooling* through 160 degrees, or from 200° to 40° .

In respect to the *cooling* of the instrument, it is necessary that I should inform my reader, that, though I have not in the tables of the experiments mentioned any higher temperature than that of 200° , yet the instrument was always heated to the point of boiling water, which, under the pressure of the atmosphere at Munich, where the experiments were made, was commonly about $209\frac{1}{2}$ deg. of Fahrenheit's scale. The instrument, being kept in boiling water till its thermometer appeared to be quite stationary, was then taken out of the water and instantly plunged into melting ice, and the time was observed and carefully noted down when the liquid in its thermometer passed the division of its scale which indicated 200° , as also when it arrived at the other divisions indicated in the tables.

With regard to the four last-mentioned experiments (No. 2, 4, 6, and 8), it will be found, on examination, that their results correspond very exactly with those before described; and they certainly prove in a very decisive manner this important fact, — *that a small proportion*

of certain substances, on being mixed with water, tend very powerfully to impair the conducting power of that Fluid in regard to Heat.

In the experiments No. 1 and No. 2, which were both made on the same day, and in the order in which they are numbered, the Heat was considerably more obstructed in its passage through the mass of stewed apples which surrounded the thermometer than in the experiments No. 3 and No. 4, which were made on the following day. It is probable that this was occasioned by some change in the consistency of this soft mass of the stewed apples which had taken place while the instrument was left to repose in the interval between the experiments; but instead of stopping to show how this might be explained, I shall proceed to give an account of some experiments from the results of which we shall derive information that will be much more satisfactory than any speculations I could offer on that subject.

Supposing Heat to be propagated in water in the same manner as it is propagated in air and other elastic Fluids, namely, that it is *transported* by its particles, these particles being put in motion by the change which is produced in their specific gravity by the change of temperature, and that there is no communication whatever, or *interchange of their Heat*, among the particles of *the same Fluid*; in that case it is evident that the propagation of Heat in a Fluid may be obstructed in two ways, namely, by diminishing its *Fluidity* (which may be done by dissolving in it any mucilaginous substance); or, more simply, by merely embarrassing and obstructing the motion of its particles in the operation of transporting the Heat, which may be effected by mixing with the Fluid any solid substance (it must be a non-conductor of Heat, how-

ever) in small masses, or which has a very large surface in proportion to its solidity.

In the foregoing experiments with *stewed apples*, the passage of the Heat in the water (which constituted by far the greatest part of the mass) was doubtless obstructed in both these ways. The mucilaginous parts of the apples diminished very much the fluidity of the water, at the same time that the fibrous parts served to embarrass its internal motions.

In order to discover the *comparative effects* of these two causes, it was necessary to separate them, or to contrive experiments in which only one of them should be permitted to act at the same time. This I endeavoured to do in the following manner.

To ascertain the effects produced by diminishing the *fluidity* of water, I mixed with it a small quantity of starch, namely, 192 grains in weight to 2276 grains of water; and to determine the effects produced by merely *embarrassing* the water in its motions, I mixed with it an equal proportion (by weight) of *eider-down*. The starch was boiled with the water with which it was mixed, as was also the eider-down. This last-mentioned substance was boiled in the water in order to free it from air, which, as is well known, adheres to it with great obstinacy.

In order that these experiments may with greater facility be compared with those which were made with *stewed apples* and with *pure water*, I shall place their results all together in the following tables.

Time the Heat was in passing INTO the Thermometer.				
Through a Mixture of 2276 Grains of Water and 192 Grains of STARCH.	Through a Mixture of 2276 Grains of Water and 192 Grains of EIDER-DOWN.	Through STEWED APPLES.	Through Pure WATER.	
Experiment No. 9.	Experiment No. 11.	Mean of Two Experiments, No. 1 and No. 3.	Mean of Two Experiments, No. 5 and No. 7.	
Seconds.	Seconds.	Seconds.	Seconds.	
In heating the Thermometer from 32° to 40°	101	83	92	45
from 40 to 60	72	55	71	35½
60 to 80	64	49	58½	32½
100	63	52	62½	30
120	74	57	69½	36½
140	89	67	86	44
160	115	93	117	61½
180	178	133	179	91½
200	453	360	362	220½
Total times in heating the instrument from 32° to 200°	1109	949	1096½	597
Times employed in heating the Thermometer 80 degrees, viz. from 80° to 160°	341"	269"	335"	172"

Time the Heat was in passing OUT of the Thermometer.				
	Through a Mixture of 2276 Grains of Water and 192 Grains of STARCH.	Through a Mixture of 2276 Grains of Water and 192 Grains of EIDER-DOWN.	Through STEWED APPLES.	Through Pure WATER.
	Experiment No. 10.	Experiment No. 12.	Mean of Two Experiments, No. 2 and No. 4.	Mean of Two Experiments, No. 6 and No 8.
	Seconds.	Seconds.	Seconds.	Seconds.
In cooling the Thermometer from 200° to 180° . . .	69	68	77	41½
from 180° to 160°	66	61	73½	39½
160 to 140	74	72	83½	43
120	92	91	104	52½
100	119	120	138½	73
80	173	177	194	108½
60	283	279	314	202
40	672	673	754	472
Total times in cooling from 200° to 40°	1548	1541	1749½	1032
Times employed in cooling the instrument 80 degrees, viz. from 160° to 80°	468"	460"	520"	277"

As the results of these experiments prove, in the most decisive manner, that the propagation of Heat in water is retarded, not only by those things which diminish its fluidity, but also by those which, by mechanical means, and without forming any combination with it whatever, merely obstruct its internal motions, it appears to me that this proves, almost to a demonstration, that Heat is propagated in water *in consequence* of its internal motions, or that it is transported or *carried* by the particles of that liquid, and that it does not spread and expand in it, as has generally been imagined.

I have shewn in another place, and I believe I may venture to say I have proved,* that Heat is actually propagated in *air* in the same manner I here suppose it to be propagated in water, and if the conducting powers of both these fluids are found to be impaired by the *same means*, it affords very strong grounds to conclude that they both conduct Heat in the *same manner*; but this has been found to be actually the case.

Eider-down, which cannot affect the specific qualities of either of those fluids, and which certainly does no more when mixed with them than merely to obstruct and embarrass their internal motions, has been found to retard very much the propagation of Heat in both of them: on comparing these experiments with those I formerly made on the conducting power of air, it will even be found that the conducting power of water is nearly, if not quite, as much impaired by a mixture of *eider-down* as that of air.

In the course of my experiments on the various substances used in forming artificial clothing for confining Heat, I found that the thickness of a stratum of air, which served as a barrier to Heat, remaining the same, the passage of Heat through it was sometimes rendered more difficult by increasing the quantity of the light substance which was mixed with it to obstruct its internal motion.

To see if similar effects would be produced by the same means when Heat is made to pass through water, I repeated the experiments with *eider-down*, reducing the quantity of it mixed with the water to 48 grains, or *one quarter* of the quantity used in the experiments No. 11 and No. 12.

* See Philosophical Transactions, 1792.

The results of these experiments, and a comparison of them with those before mentioned, may be seen in the following tables: —

Time the Heat was in passing INTO the Thermometer.			
	Through Water with 48 Grains, or $\frac{1}{50}$ of its Bulk of EIDER-DOWN.	Through Water with 192 Grains, or $\frac{4}{50}$ of its Bulk of EIDER-DOWN.	Through Pure WATER.
	Experiment No. 13.	Experiment No. 11.	Mean of Two Experiments, No. 5 and No. 7.
	Seconds.	Seconds.	Seconds.
In heating the Thermometer } from . . . 32° to 40° } from 40 to 60 60 to 80 100 120 140 160 180 200	51 47 39 40 45 56 74 118 293	83 55 49 52 57 67 93 133 360	45 35½ 32½ 30 36½ 44 61½ 91½ 220½
Total times in heating from } 32° to 200° }	763	949	597
Times employed in heating } the instrument 80 degrees, } or from 80° to 160° . . }	215"	269"	172"

Time the Heat was passing OUT of the Thermometer.				
Through Water with 48 Grains, or $\frac{1}{20}$ of its Bulk of EIDER-DOWN.		Through Water with 192 Grains, or $\frac{4}{50}$ of its Bulk of EIDER-DOWN.		Through Pure WATER.
Experiment No. 14.		Experiment No. 12.		Mean of Two Experiments, No. 6 and No. 8.
Seconds.		Seconds.		Seconds.
In cooling the Thermometer } from . . . 200° to 180° } from 180 to 160 } 160 to 140 } 120 } 100 } 80 } 60 } 40 }	49	68	41½	
	50	61	39½	
	56	72	43	
	70	91	52½	
	96	120	73	
	151	177	108½	
	262	279	202	
	661	673	472	
Total times in cooling from } 200° to 40° }	1395	1541	1032	
Times employed in cooling } the instrument 80 degrees, } viz. from 160° to 80° . }	373"	460"	277"	

The results of these experiments are extremely interesting. They not only make us acquainted with a new and very curious fact, namely, that feathers and other like substances, which, in air, are known to form very warm covering for confining Heat, not only serve the same purpose in water, but that their effect in preventing the passage of Heat is even greater in water than in air.

This discovery, if I do not deceive myself, throws a very broad light over some of the most interesting parts of the economy of Nature, and gives us much satisfactory information respecting the final causes of many phenomena which have hitherto been little understood.

As *liquid water* is the vehicle of Heat and nourishment, and consequently of life, in every living thing; and as water, left to itself, freezes, with a degree of cold much less than that which frequently prevails in cold climates, it is agreeable to the ideas we have of the wisdom of the Creator of the world to expect that effectual measures would be taken to preserve a sufficient quantity of that liquid in its fluid state to maintain life during the cold season: and this we find has actually been done; for both plants and animals are found to survive the longest and most severe winters; but the means which have been employed to produce this miraculous effect have not been investigated, — at least not in as far as they relate to vegetables.

But as animal and vegetable bodies are essentially different in many respects, it is very natural to suppose that the means would be different which are employed to preserve them against the fatal effects which would be produced in each by the congelation of their fluids.

Among organized bodies which live on the surface of the earth, and which, of course, are exposed to the vicissitudes of the seasons, we find that as the proportion of fluids to solids is greater, the greater is the Heat which is required for the support of life and health, and the less are they able to endure any considerable change of their temperature.

The proportion of Fluids to Solids is much greater in *animals* than in vegetables; and in order to preserve in them the great quantity of Heat which is necessary to the preservation of life, they are furnished with lungs, and are warmed by a process similar to that by which Heat is generated in the combustion of inflammable bodies.

Among *vegetables*, those which are the most succulent are *annual*. Not being furnished with lungs to keep the great mass of liquids warm, which fill their large and slender vessels, they live only while the genial influence of the sun warms them and animates their feeble powers, and they droop and die as soon as they are deprived of his support.

There are many tender plants to be found in cold countries, which die in the autumn, the roots of which remain alive during the winter, and send off fresh shoots in the ensuing spring. In these we shall constantly find the roots more compact, and dense than the stalk, or with smaller vessels and a smaller proportion of Fluids.

Among the trees of the forest we shall constantly find that those which contain a great proportion of *thin watery liquids* not only shed their leaves every autumn, but are sometimes frozen, and actually killed, in severe frosts. Many thousands of the largest walnut-trees were killed by the frost in the Palatinate during the very cold winter in the year 1788 ; and it is well known that few, if any, of the deciduous plants of our temperate climate would be able to support the excessive cold of the frigid zone.

The trees which grow in those inhospitable climates, and which brave the colds of the severest winters, contain very little watery liquids. The sap which circulates in their vessels is thick and viscous, and can hardly be said to be fluid. Is there not the strongest reason to think that this was so contrived for the express purpose of preventing their being deprived of all their Heat, and killed by the cold during the winter ?

We have seen by the foregoing experiments how much the propagation of Heat in a liquid is retarded by diminishing its fluidity ; and who knows but this may

continue to be the case as long as any degree of fluidity remains ?

As the bodies and branches of trees are not covered in winter by the snow which protects their roots from the cold atmosphere, it is evident that extraordinary measures were necessary to prevent their being frozen. The bark of all such trees as are designed by nature to support great degrees of cold forms a very warm covering ; but this precaution alone would certainly not have been sufficient for their protection. The sap in all trees which are capable of supporting a long continuance of frost grows thick and viscous on the approach of winter. What more important purpose could this change answer than that here indicated ? And it would be more than folly to pretend that it answers no useful purpose at all.

We have seen by the results of the foregoing experiments how much the simple embarrassment of liquids in their internal motions tends to retard the propagation of Heat in them, and consequently its passage out of them ; — and when we consider the extreme smallness of the vessels in which the sap moves in vegetables and particularly in large trees ; when we recollect that the substance of which these small tubes are formed is one of the best non-conductors of Heat known ; * and when we ad-

* I lately, by accident, had occasion to observe a very striking proof of the extreme difficulty with which Heat passes in wood. Being present at the foundery at Munich when cannons were casting, I observed that the founder used a wooden instrument for stirring the melted metal. It was a piece of oak plank, green or unseasoned, about ten inches square and two inches thick, with a long wooden handle which was fitted into a hole in the middle of it. As this instrument was frequently used, and sometimes remained a considerable time in the furnace, in which the Heat was most intense, I was surprised to find that it was not consumed ; but I was still more surprised, on examining the part of the plank which had been immersed in the melted metal, to find that the Heat had penetrated it to so inconsiderable a depth, that, at the distance of one twentieth of an inch below its surface, the wood did not seem to have been in the least affected by it. The colour of the wood remained unchanged, and it did not appear to have lost even its moisture.

vert to the additional embarrassments to the passage of the Heat which arise from the increased viscosity of the sap in winter, and to the almost impenetrable covering for confining Heat which is formed by the bark, we shall no longer be at a loss to account for the preservation of trees during the winter, notwithstanding the long continuation of the hard frosts to which they are annually exposed.

On the same principles we may, I think, account in a satisfactory manner for the preservation of several kinds of fruit — such as apples and pears, for instance — which are known to support, without freezing, a degree of cold which would soon reduce an equal volume of *pure water* to a solid mass of ice.

At the same time that the compact skin of the fruit effectually prevents the evaporation of its fluid parts, which, as is well known, could not take place without occasioning a very great loss of Heat, the internal motions of those fluids are so much obstructed by the thin partitions of the innumerable small cells in which they are confined, that the communication of their Heat to the air ought, according to our hypothesis, to be extremely slow and difficult. These fruits do, however, freeze at last, when the cold is very intense; but it must be remembered that they are composed almost entirely of liquids, and of such liquids as do not grow viscous with cold, and, moreover, that they were evidently not designed to support for a long time very severe frosts.

Parsnips and carrots, and several other kinds of roots, support cold without freezing still longer than apples and pears, but these are less watery, and I believe the vessels in which their fluids are contained are smaller; and both these circumstances ought, according to our assumed

principles, to render the passage of their Heat out of them more difficult, and consequently to retard their congelation.

But there is still another circumstance, and a very remarkable one indeed, which, if our conjectures respecting the manner in which Heat is propagated in liquids be true, must act a most important part in the preservation of Heat, and consequently of animal and vegetable life, in cold climates. But as the probability of all these deductions must depend very much on the evidence which is brought to prove the great fundamental fact on which they are established, — that respecting the internal motions among the particles of liquids which *necessarily* take place when they are heated or cooled, — before I proceed any farther in these speculations, I shall endeavour to throw some more light on that curious and interesting subject.

CHAPTER II.

Farther Investigations of the internal Motions among the Particles of Liquids which necessarily take place when they are heated or cooled. — Description of a mechanical Contrivance, by which these Motions in Water were rendered visible. — An Account of various amusing Experiments which were made with this new-invented Instrument. — They lead to an important Discovery. — Heat cannot be propagated DOWNWARDS in Liquids, as long as they continue to be condensed by Cold. — Ice found, by Experiment, to melt more than eighty times slower when boiling-hot Water stood on its Surface, than when the Ice was suffered

to swim on the Surface of the hot Water. — The melting of Ice by Water standing on its Surface can be accounted for, even on the supposition that Water is a perfect Non-conductor of Heat. — According to the assumed Hypothesis, Water only eight Degrees of Fahrenheit's Scale above the freezing Point, or at the Temperature of 40° , ought to melt as much ice, in any given Time, when standing on its Surface, as an equal Volume of that Fluid at any higher Temperature, even were it boiling hot. — This remarkable Fact is proved by a great Variety of decisive Experiments. — Water at the Temperature of 41° is found to melt even MORE Ice, when standing on its Surface, than boiling-hot Water. — The Results of all these Experiments tend to prove that Water is, in fact, a perfect Non-conductor of Heat; or that Heat is propagated in it merely in consequence of the Motions it occasions among the insulated or solitary Particles of that Fluid, which, among themselves, have no Communication or Intercourse whatever in this Operation. — The Discovery of this Fact opens to our View one of the grandest and most interesting Scenes in the Economy of Nature.

AS the particles of water, as also of all other Fluids, are infinitely too small to be seen by human eyes, their motions must of course be imperceptible by us; but we are frequently enabled to judge with the utmost certainty of the motions of invisible Fluids by the motions they occasion in visible bodies. Air is an invisible Fluid, but we acquire very just notions of the motions in air by the dust and other light bodies which are carried along with it in its motions. Nobody who has ever seen a whirlwind sweep over the surface of a ploughed field in dry weather can have any doubt respecting the nature

of the motions into which the air is thrown on those occasions, notwithstanding that they are extremely complicated, and would be very difficult to describe.

It was by the motions of the very fine particles of dust, which by accident had been mixed with the spirits of wine in my large thermometer, and which, when strongly illuminated by the direct beams of the sun, became visible, that I first discovered the internal motions in that Fluid which take place when it is cooling; and, availing myself of this kind hint, I contrived to render the internal motions of water equally visible. This I immediately saw could be done with the utmost facility if I could but find any solid body of the same specific gravity as water, which would be proper to mix with it, — that is to say, that would not be liable to be dissolved by it, or to be reduced to such small particles as to become itself invisible; but such a substance was not to be found. On reflection it occurred to me that it is very fortunate that such substances do not abound, for otherwise we should find great difficulty in procuring water in a pure state.

Not being able to find any solid substance fit for my purpose, of the same specific gravity as pure water, I was obliged to have recourse to the following stratagem.

Looking over the tables of specific gravities, I found that the specific gravity of transparent yellow amber was but a little greater than that of water, being 1.078, while that of water is 1.000; and it occurred to me, that, by dissolving a certain quantity of pure alkaline salt, I might augment its specific gravity, or rather bring the specific gravity of the solution to be precisely equal to that of the amber, without impairing the transparency

of the liquid, or changing any of its properties, by which the manner of its receiving and transporting Heat could be sensibly affected.

This contrivance was put in execution in the following manner, with complete success. Having provided myself with a number of glass globes of various sizes, with long cylindrical necks, I chose one which was about two inches in diameter, with a cylindrical neck $\frac{3}{4}$ of an inch in diameter and twelve inches long; and putting into it about half a teaspoonful of yellow amber, in the form of a coarse powder (the pieces, which were irregular in their forms, and transparent, being about the size of mustard-seeds), I poured upon it a certain quantity of distilled water, which was at the temperature of the air in my room (about 60° F.).

Finding, as I expected, that the amber remained at the bottom of the globe, I now added to the water as much of a saturated solution of pure vegetable alkali as was sufficient to increase the specific gravity of the water (or rather of the diluted saline solution), till the pieces of amber began to float, and remained apparently motionless in any part of the liquid where they happened to rest.

As the glass body was not yet as full as I wished, I continued to add more of the alkaline solution and of water, in due proportions, till the globe was full, and also till its cylindrical tube was filled to within about three inches of its end, and then closed it well with a clean cork.

Having shaken the contents of this glass body well together, I placed it, with its cylindrical tube in a vertical position, on a wooden stand, and left it to repose in quiet, in order to see how long the solid particles of amber (which appeared to be very equally dispersed about in the whole mass of the liquid) would remain suspended.

Though the greater number of these particles seemed at first to have no tendency either to ascend or to descend, yet some of them soon began to move very slowly upwards, and others to move as slowly downwards; and as these particles were moving at the same time promiscuously in all parts of the same liquid, and even in the same part of it in both directions at the same time, the ascending and descending particles frequently passing each other so near as to touch, I saw that these motions were independent of any internal motion of the liquid, and arose merely from the difference of the specific gravity of the different small pieces of the amber and of that of the liquid. Some of the pieces of amber, being evidently heavier than the liquid, moved downward, while others which were lighter ascended to its surface.

Finding that there was so much difference in the specific gravities of the different pieces of amber, I now added more of this substance to the liquid, and suffering it to subside after I had shaken it well together, I gently poured off what had risen to the top of the liquid, and retaining only that which had settled at the bottom of it, I increased the specific gravity of the liquid by adding a little of the alkaline solution till the small pieces of amber which remained in the glass were just buoyed up and suspended in the different parts of the Fluid, where they seemed to have taken their permanent stations.

I had now an instrument which appeared to me to be well calculated for the very interesting experiments I had projected, and it will easily be imagined that I lost no time in making use of it.

The first experiment I made with this instrument was to plunge it into a tall glass jar nearly filled with water

almost boiling hot. The result was just what I expected. Two currents, in opposite directions, began at the same instant to move with great celerity in the liquid in the cylindrical tube, the ascending current occupying the sides of the tube, while that which moved downwards occupied its axis.

As the saline liquor grew warm, the velocity of these currents gradually diminished, and at length, when the liquor had acquired the temperature of the surrounding water in the jar, these motions ceased entirely.

On taking the glass body out of the hot water, the internal motions of the liquor recommenced, but the currents had changed their directions, that which occupied the axis of the tube being now the ascending current.

When the cylindrical tube, instead of being held in a vertical position, was inclined a little, the ascending current occupied that side of it which happened to be uppermost, while the under side of it was occupied by the current which moved (with equal velocity) downwards.

When the contents of the glass body had acquired the temperature of the air of the room, these motions ceased ; but they immediately recommenced on exposing the instrument to any change of temperature.

In all cases where the instrument *received Heat*, the current in the axis of its cylindrical tube when it was placed in a vertical position (and that which occupied its *upper side* when it was inclined) moved downwards. When it parted with Heat, its motion was in an opposite direction, that is to say, *upwards*.

A change of temperature amounting only to a few degrees of Fahrenheit's scale was sufficient to set the contents of the instrument in motion ; and the motion was more or less rapid as the velocity was greater or less with

which it acquired or parted with Heat, and the motion was most rapid in those parts of the instrument where the communication was not rapid.

A partial motion might at any time be produced in any part of the instrument by applying to that part of it any body either hotter or colder than the instrument. If the body so applied were hotter than the instrument, the motion of the saline liquor in it in that part of it immediately in contact with the hot body was *upwards*; if colder, downwards; and whenever a hot or cold body produced a current upwards or downwards, this current immediately produced another in some other part of the liquid which flowed in an opposite direction.

On inclining the cylindrical tube of the instrument to an angle of about 45 degrees with the plane of the horizon, and holding the middle of it over the flame of a candle at the distance of three or four inches above the point of the flame, the motion of the Fluid in the upper part of the tube became excessively rapid, while that in the lower end of it where it was united to the globe, as well as that in the globe itself, remained almost perfectly at rest.

I even found that I could make the Fluid in the upper part of the tube *actually boil*, without that in the lower part of it appearing to the hand to be sensibly warmed. But when the flame was directed against the lower part of the tube, all the upper parts of it in contact with the liquid, and especially that side of it which was uppermost as it lay in an inclined position, where the ascending current was most rapid, where it impinged against the glass, were very soon heated very hot.

The motions in opposite directions in the liquid in the tube were exceedingly rapid on this sudden applica-

tion of a strong Heat, and afforded a very entertaining sight ; but to a scientific observer they were much more than amusing. They detected Nature, as it were, in the very act, in one of her most hidden operations, and rendered motions visible in the midst of an invisible medium which never had been seen before, and which most probably had never been suspected.

Encouraged by this success, and confirmed in my opinions respecting the interesting fact I had undertaken to investigate, I now proceeded with confidence to still more direct and decisive experiments.

It is an opinion which, I believe, is generally received among philosophers, that water cannot be heated in contact with ice : reflecting on the subject, I immediately perceived that either this must be a mistake or all my ideas respecting the manner in which Heat is propagated in that Fluid must be erroneous. I saw that as long as the ice floats at the surface of water which is attempted to be warmed over a fire, (or in any other way,) the ice-cold water which results from the melting of the ice must, according to my own hypothesis, descend, and, spreading over the bottom of the containing vessel, and, before it has time to be much heated, being in its turn forced to give place to the ice-cold water which, as long as any ice remains, continues to descend in an uninterrupted stream as long as this operation is going on, the mass of the water cannot be much heated ; but on the supposition that water is not a conductor of Heat, according to the common acceptation of that term, or that Heat cannot pass in that Fluid except when it is *carried* by its particles, which, being put in motion by the change it occasions in their specific gravity, *transport* it from place to place, it does not appear how ice, if, instead

of being permitted to swim on water, it were confined at the bottom of it or at any given distance below its surface, could in any way affect the temperature of the superincumbent water, or prevent its receiving Heat from other bodies.

Were water a conductor of Heat, there is no doubt but that the influence of the presence of the ice would be propagated in the water in all directions.

The metals are all conductors of Heat, and Professor Pictet found, by an ingenious and decisive experiment,* that in a bar of copper 33 inches in length, placed in a vertical position, Heat passed downwards as well as upwards, and nearly with the same facility in both these directions; and if it can be shown that Heat cannot descend in water, that alone will, I imagine, be thought quite sufficient to prove that water is not a conductor of Heat.

When we meditate profoundly on the nature of Fluidity, it seems to me that we can perceive some faint lights which might lead us to suspect that the *cause*, and I may say the very *essence, of fluidity*, is that property which the particles of bodies acquire when they become fluid, by which all farther interchange or communication of Heat among them is prevented. But however this may be, the result of the following experiments will certainly be considered as affording indisputable evidence of one important fact respecting the manner in which Heat is propagated in water.

Experiment No. 15.

Into a cylindrical glass jar 4.7 inches in diameter and 14 inches high, I fitted a circular cake of ice nearly as

* Essais de Physique, Tome I. Genève. 1790.

large as the internal diameter of the jar, and $3\frac{1}{2}$ inches thick, weighing $10\frac{1}{8}$ oz.

This cake of ice being ready, I now poured into the jar 6 lb. $1\frac{1}{4}$ oz., Troy, of boiling-hot water, and, putting the ice gently into it, I found that it was entirely melted in 2 minutes and 58 seconds.

Having found by this experiment how long the ice was in melting at the surface of the hot water, I now endeavoured to find out whether it would not require a longer time to melt at the bottom of the water.

Experiment No. 16.

Into the same jar which was used in the foregoing experiment, I now put a cake of ice of the same form and dimensions as that above described, but, instead of letting it swim at the surface of the hot water, I fastened it down on the bottom of the jar and poured the water upon it.

This cake of ice was fastened down in the jar by means of two slender and elastic pieces of deal about $\frac{1}{8}$ of an inch thick, and $\frac{1}{4}$ of an inch wide, which, being a trifle longer than the internal diameter of the jar, were of course a little bent when they were introduced into it in an horizontal position, and, on being put down upon the ice at right angles to each other served to confine the ice, and prevent its rising up to the surface when the water was put into the jar upon it.

To protect the ice while the boiling-hot water was pouring into the jar, its surface was covered with a circular piece of strong writing-paper, which was afterwards removed as gently as possible by means of a string which was fastened to one side of it; and to prevent the glass jar from being cracked by the sudden application of the

boiling-hot water, I began by pouring a small quantity of cold water into the jar, just enough to fill up the interstices between the ice and the glass, and to cover the ice to the height of about $\frac{1}{4}$ of an inch; and in pouring the hot water into the jar, out of a large tea-kettle in which it had been boiled, I took care to direct the stream against the middle of the circular piece of paper which covered the ice.

The jar with the ice and the hot water in it being placed on a table near a window, I drew away as gently as possible the paper which covered the surface of the ice, and prepared myself to observe at my ease the result of this most interesting experiment.

A very few moments were sufficient to show me that my expectation with regard to it would not be disappointed. In the former experiment a similar cake of ice had been entirely melted in less than three minutes; but in this, after more than twice that time had elapsed, the ice did not show any apparent signs of even *beginning to melt*. Its surface remained smooth and shining, and the water immediately in contact with it appeared to be perfectly at rest, though the internal motions of the hot water above it, which was giving off its heat to the sides of the jar and to the air, were very rapid, as I could distinctly perceive by means of some earthy particles or other impurities which this water happened to contain.

I examined the ice with a very good lens, but it was a long time before I could perceive any signs of its melting. The edges of the cake remained sharp, and the minute particles of dust, which by degrees were precipitated by the hot water as it grew colder, remained motionless as soon as they touched the surface of the ice.

As the hot water had been brought from the kitchen

in a tea-kettle, it was not quite boiling hot when it was poured into the jar. After it had been in the jar one minute I plunged a thermometer into it, and found its temperature to be at 180° .

After 12 minutes had elapsed, its temperature at the depth of one inch under the surface was 170° . At the depth of seven inches, or one inch above the surface of the ice, it was at $169\frac{1}{10}$, while at only $\frac{3}{4}$ of an inch lower, or $\frac{1}{4}$ above the surface of the ice, its temperature was 40° .

When 20 minutes had elapsed, the Heat in the water at different depths was found to be as follows : —

Immediately above the surface of the ice	40°
At the distance of $\frac{1}{2}$ an inch above it	46
At 1 inch	130
At 3 inches	159
At 7 inches	160

When 35 minutes had elapsed, the Heat was as follows : —

At the surface of the ice	40°
$\frac{1}{2}$ an inch above it	76
1 inch above it	110
2 inches	144
3 inches	148
5 inches	$148\frac{1}{2}$
7 inches	149

At the end of one hour the Heat was as follows : —

At the surface of the ice	40°
1 inch above it	80
2 inches	118
3 inches	128
4 inches	130
7 inches	131

After 1 hour and 15 minutes had elapsed, the Heat was found to be as follows : —

At the surface of the ice	40°
1 inch above it	82
2 inches	106
3 inches	123

The Heat of the water had hitherto been taken near the side of the jar ; in the two following trials it was measured in the middle or axis of the jar.

When 1 hour and 30 minutes (reckoning always from the time when the boiling-hot water was poured into the jar) had elapsed, the Heat of the water in the middle of the jar was found to be as follows : —

At the surface of the ice	40°
1 inch above it	84
2 inches	115
3 inches	116
7 inches	117

When 2 hours had elapsed, the Heat in the middle of the jar was found to be as follows : —

At the surface of the ice	40°
1 inch above it	76
2 inches	94
3 inches	106
4 inches	108
6 inches	108½
7 inches	108½

An end being now put to the experiment, the hot water was poured off from the ice, and on weighing that which remained, it was found that 5 oz. 6 grains, Troy, (= 2406 grains) of ice had been melted.

Taking the mean temperature of the water at the end

of the experiment at 106° , it appears that the mass of hot water (which weighed $73\frac{1}{4}$ ounces) was cooled 78 degrees, or from the temperature of 184° to that of 106° , during the experiment. Now, as it is known that one ounce of ice absorbs just as much Heat in being changed to water as one ounce of water loses in being cooled 140 degrees, it is evident that one ounce of water which is cooled 78 degrees gives off as much Heat as would be sufficient to melt $\frac{78}{140}$ of an ounce of ice; consequently the $73\frac{1}{4}$ ounces of hot water, which in this experiment were cooled 78 degrees, actually gave off as much Heat as would have been sufficient to have melted $\frac{73\frac{1}{4} \times 78}{140} = 40\frac{8}{10}$ ounces of ice.

But the quantity of ice actually melted was only about five ounces; and hence it appears that *less than one-eighth part of the Heat lost by the water was communicated to the ice*, the rest being carried off by the air.

As the same quantity of hot water was used in this experiment and in that, No. 15, which immediately preceded it, and as this water was contained by the same vessel (the glass jar above described), it appears that ice melts more than *eighty times slower* at the bottom of a mass of boiling-hot water than when it is suffered to swim on its surface. For, as in the experiment No. 15, $10\frac{1}{8}$ oz. of ice were melted in 2 minutes and 58 seconds, 5 ounces at least must have been melted in 1 minute and 29 seconds; but in the experiment No. 16, 2 hours, or 120 minutes, were employed in melting 5 ounces.

The ice however *was melted*, though very slowly, at the bottom of the hot water; and that circumstance alone would have been sufficient to have overturned my hypothesis respecting the manner in which Heat is propagated in liquids, had I not found means to account in a satis-

factory manner for that fact without being obliged to abandon my former opinions.

In about half an hour after the hot water had been poured into the jar, in the last experiment, examining the surface of the ice, I discovered an appearance which fixed my attention and excited all my curiosity; I perceived that the ice had been melted and diminished at its surface, excepting only where it had been covered, or, as it were, *shadowed*, by the flat slips of deal by which the cake of ice was fastened down in its place.

Had the ice been protected and prevented from being melted by that piece of the wood *only* which, being undermost of the two, reposed immediately on the surface of the ice, I should not perhaps have been much surprised; but that part of the surface of the ice being likewise protected which was situated immediately under the other piece of wood, — that which, lying across the under piece and resting on it, *did not touch the ice anywhere except just at its edge*, — that circumstance attracted my attention, and I could at first see no way of accounting for these appearances but by supposing that the ice had been melted by the *calorific rays* which had been emitted by the hot water, and that those parts of the ice which had been *shadowed* by the pieces of deal, receiving none of these rays, had, of course, not been melted.

I was so much struck with these appearances that I immediately made the following experiments, with a view merely to the elucidation of this matter.

Experiment No. 17.

Into a cylindrical glass jar, $6\frac{1}{2}$ inches in diameter and 8 inches high, I put a circular cake of ice, as large as could be made to enter the jar, and about $3\frac{1}{2}$ inches

thick ; and on the flat and even surface of the ice I placed a circular plate of the thinnest tin I could procure, near $6\frac{1}{2}$ inches in diameter, or sufficiently large just to cover the ice. This plate of tin (which, to preserve its form, or keep it quite flat, was strengthened by a strong wire which went round it at its circumference) had a circular hole in its center, just two inches in diameter, and it was firmly fixed down on the upper surface of the cake of ice by means of several thin wooden wedges which passed between its circumference and the sides of the jar.

A second circular plate of tin, with a circular hole in its center two inches in diameter, and in all other respects exactly like that already described, was now placed over the first, and parallel to it, at the distance of just one inch, and like the first was firmly fixed in its place by wooden wedges.

These perforated circular plates being fixed in their places, the jar was placed in a room where Fahrenheit's thermometer stood at 34° , and ice-cold water was poured into it till the water just covered the upper plate, and then the jar was filled to within half an inch of its brim with boiling water, and, being covered over with a board, was suffered to remain quiet two hours.

At the end of this time the water, which was still warm, was poured off, and, the circular plate being removed, the ice was examined.

A circular excavation just as large as the hole in *the* tin plate which covered the ice (namely, two inches in diameter), and corresponding with it, perfectly well defined, and about $\frac{2}{10}$ of an inch deep in the center, had been made in the ice.

This was what I expected to find ; but there was something more which I did not expect, and which, for some

time, I was quite at a loss to account for. Every part of the surface of the ice which had been covered by the tin plate appeared to be perfect, level, and smooth, and showed no signs of its having been melted or diminished, excepting only in one place, where a channel, about an inch wide and a little more than $\frac{2}{10}$ of an inch deep, which showed evident marks of having been formed by a stream of warm water, led from the excavation just mentioned, in the center of the upper part of the cake of ice, to its circumference. As the edge or vertical side of the cake of ice was evidently worn away where this stream passed, there could be no doubt with respect to its direction. It certainly ran *out of* the circular excavation in the middle of the ice; and though it might at first appear difficult to explain the fact, and to show how this hot water could arrive at that place, yet it was quite evident that the immediate cause of the motion of this stream of water could be no other than its specific gravity being greater than that of the rest of the water at the same depth; and that this greater specific gravity was at the same time accompanied by a higher degree of Heat is evident from the deep channel which this stream had melted in the ice, while other parts of the surface of the ice, at the same level, were not melted by the water which rested on it. To elucidate this point, I made the following experiment: —

Experiment No. 18.

Thinking it probable that if the circular excavation in the ice, which answered to the circular hole in the middle of the tin plate which covered the ice, and also to that in the second plate which was placed an inch higher, had been melted by *radiant Heat* (as it has improperly

been called), or by the calorific rays from the hot water; then, in that case, as some of these rays must probably have been reflected downwards at the surface of the water in attempting to pass upwards into the air, I thought that by preventing this part of them from reaching the ice, which I endeavoured to do by causing them to be absorbed by a light black body (a circular piece of deal board covered over with black silk), which I caused to swim on the surface of the water, their effects in melting the ice might perhaps be sensibly diminished. Had this really been the case, it would certainly have afforded strong grounds to suspect that these rays were in fact the cause of the appearances in question; but on making the experiment with the greatest care, I could not perceive that the covering of the surface of the hot water with a black body produced any difference whatever in the result of the experiment as it was first made (experiment No. 17), or when this black covering was not used.

After some meditation on the subject, it occurred to me that this melting of the ice at its upper surface could be accounted for in a manner which appeared to me to be perfectly satisfactory; without supposing either that water is a conductor of Heat or that the effect in question was produced by calorific rays.

Though it is one of the most general laws of nature with which we are acquainted, that all bodies, solids as well as fluids, are condensed by cold, yet in regard to *water* there appears to be a very remarkable exception to this law. Water, like all other known bodies, is indeed condensed by cold at every degree of temperature which is considerably higher than that of freezing, but its condensation, on parting with Heat, does not go on till it

is changed to ice; but when, in cooling, its temperature has reached to the 40th degree of Fahrenheit's scale, or eight degrees above freezing, it ceases to be farther condensed; and on being cooled still farther, *it actually expands*, and continues to expand as it goes on to lose more of its Heat, till at last it freezes; and at the moment when it becomes solid, and even after it has become solid, it expands still more on growing colder. This fact, which is noticed by M. de Luc in his excellent treatise on the modifications of the atmosphere, has since been farther investigated and put beyond all doubt by Sir Charles Blagden. See Philosophical Transactions, Vol. LXXVIII.

Now, as water in contact with melting ice is always at the temperature of 32° , it is evident that water at that temperature must be specifically lighter than water which is eight degrees warmer, or at the temperature of 40° ; consequently, if two parcels of water at these two temperatures be contained in the same vessel, that which is the coldest and lightest must necessarily give place to that which is warmer and heavier, and currents of the warmer water will *descend* in that which is colder.

In the two last experiments, as the circular tin plate which covered the surface of the ice served to confine the thin sheet of water which was between the plate and the ice, as this water could not rise upwards, being hindered by the plate, and as it had no tendency to descend, it is probable that it remained in its place; and as it was *ice-cold*, it was not capable of melting the ice on which it reposed.

But as the tin plate had a circular hole in its center, the surface of the ice *in that part* was of course naked, and, the ice-cold water in contact with it being displaced by the warmer and heavier water from above, an excava-

tion, in the form of a shallow basin, was formed in the ice by this descending warm current.

The warm water contained in this basin overflowed its banks as soon as the basin began to be formed, and, issuing out on that side which happened to be the lowest, opened itself a passage under the tin plate to the edge of the ice, over which it was precipitated and fell down to the bottom of the jar. The water of this rivulet being warm, it soon formed for itself a deep channel in the ice, and at the end of the experiment it was found to be everywhere *deeper* than the bottom of the basin where it took its rise.

This manner of accounting for the appearances in question seemed to me to be quite satisfactory ; and the more I meditated on the subject, the more I was confirmed in my suspicions that *all liquids* must necessarily be perfect *non-conductors of Heat*.

On these principles I was now enabled to account for the melting of the ice at the bottom of the hot water in the experiment No. 16, as also for the slowness with which that process went on ; and, encouraged by this success, I now proceeded with confidence to plan and to execute still more decisive experiments ; from the results of which, I may venture to say it, the important facts in question have been put beyond all possibility of doubt.

If water be in fact a perfect *non-conductor* of Heat, — that is to say, if there be *no communication whatever of Heat* between neighbouring particles or *molecules* of that fluid (which is what I suppose), then, as Heat cannot be propagated in it but *only* in consequence of the motions occasioned in the fluid by the changes in the specific gravity of those particles which are occasioned by the changes of their temperature, it follows that Heat can-

not be propagated *downwards* in water as long as that fluid continues to be condensed with cold; and that it is *only in that direction* (downwards) that it *can be propagated* after the water has arrived at that temperature where it begins to be expanded by cold, which has been found to be at about the 40th degree of Fahrenheit's scale.

Reasoning on these principles, we are led to this remarkable conclusion; namely, that *water which is only eight degrees above the freezing-point, or at the temperature of 40°*, must be able to melt as much ice in any given time, WHEN STANDING ON ITS SURFACE, as an equal volume of water at any higher temperature, EVEN THOUGH IT WERE BOILING HOT.

My philosophical reader will doubtless think that I must have had no small degree of confidence in the opinion I had formed on this interesting subject, to have had the courage to make, *even in private*, the experiments which were necessary to ascertain that fact.

Experiment No. 19.

Into a cylindrical glass jar, 4.7 inches in diameter and 13.8 inches high, I put 43.87 cubic inches, or 1 lb. 11 $\frac{1}{7}$ oz. Troy, in weight, of water, and placing the jar in a freezing mixture, composed of pounded ice and common sea-salt, I caused the water to freeze into one compact mass, which adhered firmly to the bottom and sides of the jar, and which formed a cylinder of ice just three inches high.

Had the bottom of the jar been quite flat, instead of being raised or vaulted, the cylinder of ice would have been no more than 2.67 inches high.

As soon as the water in the jar was completely frozen, the jar was removed from the freezing mixture and

placed in a mixture of pounded ice and pure water, where it was suffered to remain four hours, in order that the cake of ice in the jar might be brought to the temperature of 32° .

The jar still standing in a shallow dish in the pounded ice and water, the surface of which cold mixture was just on a level with the surface of the ice in the jar, I covered the top of the cake of ice with a circular piece of strong paper, and poured gently into the jar $73\frac{1}{4}$ oz., Troy, of boiling-hot water, which filled it to the height of eight inches above the surface of the ice. (See Plate II.)

I then removed very gently the circular piece of paper which covered the surface of the ice, and after leaving the hot water in contact with the ice a certain number of minutes, I poured it off, and, weighing immediately the jar and the unmelted ice which remained in it, I ascertained the *quantity of ice which had been melted* by the hot water during the time it had been suffered to remain in the jar.

This experiment I repeated four times the same day (16th March, 1797), varying at each repetition of it the time the water was permitted to remain on the ice. The results of these experiments were as follows: —

No. of the Experiment.	Time the Hot Water remained on the Ice.	Temperature of the Hot Water when it was poured on the Ice.	Temperature of the Water 1 Inch below its Surface at the end of the Experiment.	Quantity of Ice melted.
	Minutes.			Grains.
No. 19	1	186°	Not observed.	1632
No. 20	$3\frac{3}{4}$	185	Not observed.	1824
No. 21	15	184	170°	1757
No. 22	60	186	140	2573

From the results of these experiments it was plain that a very considerable portion of the ice which was melted,

was melted in the very beginning of the experiments, or while the hot water was actually *pouring* into the jar, which operation commonly lasted about one minute; and the irregularities in the results of the experiments, and particularly of the three first, showed evidently that the quantity of ice melted in that operation was different in different experiments. I had indeed foreseen that this would be the case, and on that account it was that I covered the surface of the ice with a circular piece of strong paper, and always took care to pour the water very gently into the jar; but I found that all these precautions were not sufficient to prevent very considerable anomalies in the results of the experiments; and as I found reason to suspect that the motion in the mass of the hot water, which was unavoidably occasioned by removing the circular piece of paper which covered the ice, was the principal cause of these inaccuracies, I had recourse to another and a better contrivance.

Having procured a flat, shallow dish, of light wood, half an inch deep, $4\frac{1}{2}$ inches in diameter (or something less than the internal diameter of the jar), and about $\frac{1}{4}$ of an inch thick at its bottom, I bored a great number of very small holes through its bottom, which gave it the appearance of a sieve. This perforated wooden dish, having been previously made *ice-cold*, was placed on the surface of the ice in the jar, and the hot water being gently poured into the dish through a long wooden tube, as this perforated dish floated and remained constantly at the surface of the water, and as the water passing through such a great number (many hundreds) of small holes was not projected downwards with force, it is evident that by this simple contrivance those violent motions in the mass of water in the jar which before took place

when the hot water was poured into the ice, and when the paper which covered the ice was removed, were in a great measure prevented.

In order that the water which was poured through the wooden tube (the bore of which was about half an inch in diameter) might not impinge perpendicularly and with force against the bottom of the dish, the lower end of the tube was closed by a fit cork-stopper, and the water was made to issue horizontally through a number of small holes in the sides of this tube, at its lower end.

As soon as the operation of pouring the hot water into the jar was finished, the perforated dish was carefully removed, and the jar was covered with a circular wooden cover, from the center of which a small mercurial thermometer was suspended.

The effects produced by this new arrangement of the machinery will appear by comparing the results of the two following experiments with those just mentioned.

No. of the Experiment.	Time the Hot Water remained on the Ice. Minutes.	Temperature of the Hot Water.		Quantity of Ice melted. Grains.
		At the Beginning.	At the End.	
No. 23	1	196°	196°	423
No. 24	3	190	188	703

In order still more effectually to prevent the inaccuracies arising from the internal motions in the mass of hot water which were occasioned in pouring the water into the jar (and which could not fail to affect, more or less, the results of the experiment), I had recourse to the following contrivance.

I filled a small phial containing $8\frac{1}{4}$ cubic inches with ice-cold water, and then, emptying the phial in the jar, I covered the surface of the ice with this ice-cold water to the height of 0.478 of an inch.

On the surface of this ice-cold water, instead of that of the ice, I now placed the perforated wooden dish, previously made ice-cold, and poured the hot water upon it.

The results of the following experiments show that this contrivance tended much to diminish the apparent irregularities of the experiments.

The air of the room in which these experiments were made was of the temperature of 41° .

No. of the Experiment.	Time the Hot Water was on the Ice. Minutes.	Temperature of the Hot Water 1 Inch below its Surface.		Quantity of Ice melted. Grains.
		At the Beginning.	At the End.	
No. 25	10	192°	182°	580
No. 26	30	190	165	914
No. 27	180	190	95	3200

From the results of these last three experiments we can now determine with a very considerable degree of certainty how much ice was melted *in the act of pouring the water into the jar*, and consequently the rate at which it was melted in the ordinary course of the experiment, — supposing equal quantities to be melted in equal times.

As in the 27th experiment 3200 grains were melted in 180 minutes, and in the 25th experiment 580 grains were melted in 10 minutes, we may safely conclude that the same quantity must have been melted in the same time (10 minutes) in the 27th experiment; if, therefore, from 3200 grains — the quantity melted in 180 minutes in this last experiment — we deduct 580 grains for the quantity melted during the first 10 minutes, there will remain 2620 grains for the quantity melted in the succeeding 170 minutes, when, the motions occasioned in the water

on its being poured into the jar having subsided, we may suppose the process of melting the ice to have gone on regularly.

But if in the regular course of the experiment no more than 2620 grains were melted in 170 minutes, it is evident that not more than 154 grains could have been melted in the ordinary course of the process in 10 minutes; for 170 minutes : 2620 grains :: 10 minutes : 154 grains. If, therefore, from 580 grains, the quantity of ice actually melted in 10 minutes in the 25th experiment, we deduct 154 grains, there remains 426 for the quantity melted in pouring the water into the jar.

Let us see, now, how far this agrees with the result of the 26th experiment. In this experiment 914 grains of ice were melted in 30 minutes. If from this quantity we deduct 426 grains, the quantity which, according to the foregoing computation, must have been melted *in pouring the hot water into the jar*, there will remain 478 grains for the quantity melted in the ordinary course of the process in 30 minutes; which gives 159 grains for the quantity melted in 10 minutes; which differs very little from the result of the foregoing computation, by which it appeared to be = 154 grains. This difference, however, small as it is, is sufficient to prove an important fact, namely, that the effects produced by the motion into which the hot water had been thrown in being poured into the jar had not ceased entirely in 10 minutes, or when an end was put to the 25th experiment. We shall therefore come nearer the truth, if, in our endeavours to discover the quantity of ice melted in any given time in the ordinary course of the experiments, we found our computation on the results of the two experiments No. 26 and No. 27.

In the latter of these experiments 3200 grains of ice were melted in 180 minutes, and in the former 914 grains were melted in 30 minutes. If, therefore, from 3200 grains, the quantity melted in 180 minutes, we take the quantity melted in the first 30 minutes, = 914 grains, there will remain 2286 grains for the quantity melted in the succeeding 150 minutes, and this gives 152 grains for the quantity melted in 10 minutes. By the former computation it turned out to be 154 grains.

But if 152 grains of ice is the quantity melted in 10 minutes, in the ordinary course of the process three times that quantity, or 456 grains only, could have been melted *in this manner* in the 30 minutes during which the 26th experiment lasted ; and deducting this quantity from 914 grains, the quantity actually melted in that experiment, the remainder, 458 grains, shews how much must have been melted in pouring the hot water on the ice, or in consequence of the motions into which the water was thrown in the performance of that operation. By the preceding computation this quantity turned out to be 426 grains.

From the result of these computations I think we may safely conclude that in the ordinary course of the experiments not more than 152 grains of ice were melted by the hot water in 10 minutes.

I shall now proceed to give an account of several experiments in which the water employed to melt the ice was at a *much lower temperature*.

Having removed a small quantity of ice which remained unmelted in the bottom of the jar, I put a fresh quantity of water into it, and placing the jar in a freezing mixture, caused this water, which filled the jar to the height of four inches, to freeze into one solid mass of

ice. I then placed the jar in a shallow earthen dish, and surrounded it to the height of the level of the top of the ice with a mixture of snow and water (see Plate II.), and, placing it in a room in which there had been no fire made for many months, and in which the temperature of the air was at 41° , I let it remain quiet two hours, in order that the ice might acquire the temperature of 32° .

This being done, I took the jar out of the earthen dish, and, wiping the outside of it dry with a cold napkin, I weighed the jar with the ice in it very exactly, and then replaced it in the earthen dish, and surrounded it as before with snow and water to the height of the level of the surface of the ice.

I then poured $73\frac{1}{4}$ ounces, Troy, ($= 15,160$ grains) of water, at the temperature of 41° , into the jar, which covered the ice to the same height to which it had been covered in the former experiments, namely, to about 8 inches; and suffering it to stand on the ice a certain number of minutes, I then poured it off, and, wiping the outside of the jar, weighed it, in order to ascertain how much ice had been melted.

In putting this cold water into the jar, the same precautions were used (by pouring it through the wooden tube into the perforated wooden dish, &c.) as were used when the experiment was made with boiling water.

The following table shews the results of six experiments made the same day (the 19th March, 1797), in the order in which they are numbered, and which were all made with the utmost care.

Number of the Experiment.	Temperature of the Water in the Jar 1 Inch below its Surface.		Temperature of the Air.	Time the Water remained on the Ice.	Quantity of Ice melted.
	At the beginning of the Experiment.	At the end of the Experiment.			
No. 28	41°	40°	41°	Minutes. 10	Grains. 203
No. 29	41	40	41	10	220
No. 30	41	40	41	10	237
No. 31	41	40	41	10	228
No. 32	41	38	41	30	617
No. 33	41	38	41	30	585

The agreement in the results of these experiments is not much less extraordinary than the surprising fact which is proved by them, namely, that boiling-hot water does not thaw more ice in any given time *when standing quietly on its surface* than water at the temperature of 41°, or nine degrees only above the point of freezing!

There is reason to conclude that it does not even thaw so much; and this still more remarkable circumstance may, I think, be accounted for in a satisfactory manner on the supposition (which, however, I imagine, will no longer be considered as a bare supposition), that water is a non-conductor of Heat.

It appeared from the results of the experiments made with hot water, that the quantity of ice melted in 10 minutes in the ordinary course of that process amounted to no more than 152 grains; but in these experiments with cold water, the quantity melted in that time was never less than 203 grains, and, taking the mean of four experiments, it amounted to 222 grains.

There is one circumstance, however, respecting these experiments with cold water, which it is necessary to investigate before their results can be admitted as complete proof in the important case in question.

In the experiments which were made with hot water, it was found that a considerable part of the ice which was melted, was melted in consequence of the motions into which the water was thrown upon being poured into the jar, and that the effect of these motions continued to be sensible for a longer time than most of these experiments with cold water lasted. Is it not possible that the results of these experiments with cold water may also have been affected by the same cause? This is what I shall endeavour to find out.

In the 32d experiment 617 grains of ice were melted in 30 minutes, and in the 33d experiment 585 grains were melted in the same time; and taking the mean of these two experiments, it appears that 601 grains were melted in 30 minutes. If now from this quantity we deduct that which, according to the mean result of the four preceding experiments, must have been melted in 10 minutes, namely, 222 grains, there will remain 379 grains for the quantity melted in the last 20 minutes in these two experiments; consequently, half this quantity, or $189\frac{1}{2}$ grains, is what must have been melted in 10 minutes in the ordinary course of the process.

But this quantity ($189\frac{1}{2}$ grains), though less than what was actually melted in the experiments which lasted only 10 minutes, is still considerably greater than 152 grains, the quantity which was found to have been melted in the same time in the ordinary course of the process in those experiments in which hot water was used; consequently, the great question, for the decision of which these experiments were contrived, is, I believe I may venture to say, decided.

But, however conclusive the result of these experiments appeared to me to be, I felt myself too much interested in the subject to rest my inquiries here.

Having found, as well from the results of the experiments made with cold water as from those made with hot water, that a considerable quantity of ice was melted in the act of pouring the water into the jar, and in consequence of those undulatory motions' into which the water was thrown in that operation, notwithstanding all the pains I had taken to diminish those motions and prevent their effects, I now doubled my precautions in guarding against those sources of error and uncertainty.

Before I poured the water into the jar I covered the surface of the ice to the height of 0.956 of an inch with ice-cold water, and this I did when water at the temperature of 41° was used, as well as in those experiments in which boiling-hot water was employed. In the former experiments I had covered the surface of the ice with ice-cold water only in those experiments in which hot water was used, and even in those I used only half as much ice-cold water as I now employed for that purpose.

I also now poured the water into the jar in a smaller stream, employing no less than three minutes in filling it up to the height of eight inches above the surface of the ice; and I endeavoured to ascertain how far the results of the experiments were influenced by the temperature of the air, and also by wrapping up the jar in warm covering.

The same jar was used in all the experiments, and it was always placed in the same earthen dish, and surrounded, to the level of the top of the ice, with melting snow. This jar is very regular in its form, being very nearly a perfect cylinder, and is on that account peculiarly well calculated for the use for which I selected it.

In each of the three first experiments which are entered in the following table, the jar was well covered up

with a very warm covering of cotton-wool. This covering (which was above an inch thick) reached from the surface of the melting snow in which the jar stood quite to the top of the jar. The mouth of the jar was first covered with a round wooden cover (from the center of which a thermometer, the bulb of which reached one inch below the surface of the water, was suspended), and on the top of this wooden cover there was put a thick covering of cotton.

In all the experiments in the following table, except the three first, the jar was exposed naked to the air, except the lower part of it, which, as I have already more than once observed, was always covered, as high as the ice in the jar reached, with melting snow or with pounded ice and water.

In the two experiments No. 37 and No. 38, which are marked with asterisks, the surface of the ice was covered with ice-cold water to the depth of 0.478 of an inch only; in all the other experiments it was covered to the depth of 0.956 of an inch.

Number of the Experiment.	Temperature of the Water in the Jar 1 Inch below its Surface.		Temperature of the Air.	Time the Water remained on the Ice.	Quantity of Ice melted.
	In the beginning of the Experiment.	At the end of the Experiment.			
No. 34	188°	179°	41°	Minutes. 30	Grains. 634
No. 35	189	180	41	30	747
No. 36	190	147	41	180	3963
No. 37	41	38	41	30	592*
No. 38	41	43	61	30	676*
No. 39	186	157	61	30	559
No. 40	188	156	61	30	575
No. 41	190	156	61	30	542
No. 42	41	43	61	30	573
No. 43	42	44	61	30	575
No. 44	42	35	61	120	2151

The results of these experiments afford matter for much curious speculation ; but I shall content myself for the present with making only two or three observations respecting them. And, in the first place, it is remarkable, that, although in the experiments No. 34 and No. 35, of 30 minutes each, considerably less ice was melted than in that No. 26, which lasted the same time, yet in that No. 36, of 180 minutes, more was melted than in that No. 27, of the same duration. This difference in the two last-mentioned experiments will be accounted for hereafter.

With regard to the difference in the results of the experiments of 30 minutes, there is no doubt but that it arose from the precautions which had been taken in this last set of experiments to prevent the effect of the violent motions into which the hot water was thrown in being poured into the jar, that less ice was melted in the experiments No. 34 and No. 35 than in that No. 26.

Secondly, It appears that more ice was melted in the same time in the experiments in which the jar was covered up with warm covering than in those in which it was left naked and exposed to the air of the room.

The difference is even considerable. The quantity melted in 30 minutes when the jar was covered, at a mean of two experiments (No. 34 and No. 35), was $690\frac{1}{2}$ grains ; but when the jar was naked, the quantity at a mean of three experiments (No. 39, No. 40, and No. 41) was only $558\frac{2}{3}$ grains.

Thirdly, The quantity of ice melted under similar circumstances — that is to say, when the jar was naked — was sensibly greater when the water was at the temperature of about 41° than when it was nearly boiling hot. In the experiment No. 41, when the water which was poured

on the ice was at the temperature of 190 deg., 542 grains only of ice were melted in 30 minutes ; whereas in the next experiment (No. 42), when the water was at 41°, or 149 degrees colder, 573 grains were melted in the same time.

Finding that covering up the jar with a thick and warm covering of cotton caused more ice to be melted by the hot water, I was curious to see what effects would be produced by keeping the jar plunged *quite up to its brim* in a mixture of snow and water, instead of merely surrounding that part of it which was occupied by the cake of ice by this cold mixture.

I was likewise desirous of finding out — and, if possible, at the same time — whether water at a temperature something above that at which that Fluid ceases to be condensed with cold would not melt more ice in any given time than an equal quantity of that Fluid, either colder or much hotter. The result of the 43d experiment had shewn me, — what indeed a very simple computation would have pointed out, — namely, that, when the temperature of the water is but a few degrees above the point of freezing, if its quantity or depth is not very considerable, it will soon be so much cooled as very sensibly to retard the process of melting the ice ; and with respect to hot water, the increased quantity of ice which was melted by it when the jar was covered up with a warm covering convinced me that the real cause which prevented the hot water from melting as much ice as the cold water in my experiments was the embarrassments in the process of melting the ice, which were occasioned by the descending currents formed in the hot water on its being cooled by the air at its surface, and by the sides of the jar.

These descending currents meeting, in the region of the constant temperature of 40° , with those cold currents which ascended from the surface of the ice, it seems very probable that the ascending currents, on the motion of which the melting of ice depends, were checked by this collision.

By retarding the cooling of the hot water above by wrapping up the jar in a warm covering, the velocity of the descending currents was of course diminished; but when this was done, the results of the experiment shewed that the melting of the ice was accelerated.

When, the jar being naked, the cooling of the hot water, and consequently the motions of the descending currents, were rapid, no more than about 542 grains, or at most 575 grains, were melted in 30 minutes; but when the jar was covered with a warm covering, 634 grains, and in one experiment (that No. 35) 747 grains, were melted in the same time.

As plunging the jar into a cold mixture of snow and water could not fail to accelerate the cooling of the hot water in the jar, and consequently to increase the rapidity of the descending currents in it, ought not this to embarrass, in an extraordinary degree, the ascending currents of ice-cold water from the surface of the ice, and to diminish the quantity of ice melted? This is what the following experiments, compared with the results of those No. 39, No. 40, and No. 41, will shew.

Number of the Experiment.	Temperature of the Water in the Jar 1 Inch below its Surface.		Temperature of the cold Mixture in which the Jar was kept plunged to its brim.	Time the Water remained on the Ice.	Quantity of Ice melted.
	In the beginning of the Experiment.	At the end of the Experiment.			
No. 45	188°	68°	32°	Minutes. 30	Grains. 406
No. 46	186	67	32	30	440
No. 47	189	68	32	30	432
No. 48	187	67	32	30	355
No. 49	188	68	32	30	364
Quantity of ice melted in these 5 experiments,					1997
Mean quantity melted by hot water when the jar was kept plunged to its brim in melting ice and water					Grains. 399½
Mean quantity melted by hot water in 30 minutes, in the two experiments, No. 26 and No. 27, when the part of the jar occupied by the water was surrounded by air, at the temperature of 41°					456
Mean quantity melted by hot water in 30 minutes, in the three experiments, No. 39, No. 40, and No. 41, when the part of the jar occupied by the water was surrounded by air, at the temperature of 61°					558½
Mean quantity melted by hot water in 30 minutes, in the two experiments, No. 34 and No. 35, when the part of the jar occupied by the water was kept covered up by a thick and warm covering of cotton					690½

As all the experiments were made in the same manner, and with equal care, and differed only in respect to the manner in which the outside of the jar, above the surface of the ice in it, was covered, their results shew the effects produced by those differences.

I should perhaps have suspected that the greater quantity of ice which was melted when the heat of the water in the jar was confined for the longest time had been occasioned, at least in part, by the Heat communicated downwards by the medium of the glass; but that this could not have been the case was evident, not only from

the manner in which the ice was always found to have been melted, but also from the results of similar experiments made with much colder water.

Had it been melted by Heat communicated by the glass, it would undoubtedly have been most melted in those parts of its surface where it was in contact with the glass ; but this I never once found to be the case.

The results of the following experiments will shew— what indeed might easily have been foreseen — that the temperature of the medium by which the upper part of the jar was surrounded does not always affect the result of the experiment in the same degree, nor even always in *the same manner*, in different experiments in which the temperature of the water in the jar is very different.

To facilitate the comparison of these experiments, and that of the foregoing, which are similar to them, I shall here place them together.

Number of the Experiment.	Temperature of the Water in the Jar 1 Inch below its Surface.		Temperature of the Medium by which the upper part of the Jar was surrounded.	Time the Water remained on the Ice.	Quantity of Ice melted.
	In the beginning of the Experiment.	At the end of the Experiment.			
No. 50	41°	36°	32°	Minutes. 30	Grains. 542
No. 37	41	38	41	30	592
No. 42	41	43	61	30	576

It is certainly very remarkable indeed that so much more ice should be melted by water at the temperature of 41°, when the jar which contained it was surrounded by a cold mixture of pounded ice and water, than by an equal quantity of boiling-hot water in the same circumstances. In the experiment No. 50, the quantity melted by the cold water was 542 grains, while that melted by

the boiling-hot water, taking the mean of five experiments (those No. 45, 46, 47, 48, and 49), was no more than $399\frac{2}{5}$ grains. But the results of the four following experiments are, if possible, still more surprising.

These experiments were made with water at the temperature of 61° , the temperature of the air of the room being at the same time 61° ; in the two first of these experiments the jar was kept plunged to its brim in a mixture of snow and water; in the two last its lower part only, namely, as high as the level of the surface of the ice, was surrounded by this cold mixture, its upper part being naked, and surrounded by the air of the room.

In each of the experiments (as in those which preceded them), before the water was poured into the jar the surface of the ice was covered to the height of 0.956 of an inch with ice-cold water, in order more effectually to defend it against the effects of the temporary motions into which the water employed to melt the ice was unavoidably thrown in the performance of this operation; and the same quantity of water was always used, namely, $73\frac{1}{4}$ ounces, Troy, or as much as was sufficient to fill the jar to the height of 8 inches.

Number of the Experiment.	Temperature of the Water in the Jar 1 Inch below its Surface.		Temperature of the Medium by which the upper part of the Jar was surrounded.	Time the Water remained on the Ice.	Quantity of Ice melted.
	In the beginning of the Experiment.	At the end of the Experiment.			
No. 51	61°	49°	32°	Minutes. 30	Grains. 660
No. 52	61	50	32	30	662
No. 53	61	60	61	30	642
No. 54	61	60	61	30	650

These experiments are remarkable, not only on account of the very small difference in the quantities of ice

melted which resulted from the cooling of the sides of the jar, but also, and more especially, as that difference was directly contrary to the effects produced by the same means in the experiments with hot water. More ice was melted when the outside of the jar was kept ice-cold than when it was surrounded by air at the temperature of 61° .

All these appearances might, I think, be accounted for in a satisfactory manner on the principles we have assumed respecting the manner in which Heat is propagated in liquids; but without engaging ourselves at present too far in these abstruse speculations, let us take a retrospective view of all our experiments, and see what general results may with certainty be drawn from them.

One of the experiments in which the greatest quantity of ice was melted by *hot water* is that No. 36, in which 3963 grains were melted in three hours, or 180 minutes. If now from this quantity we deduct that which, according to the results of the two preceding experiments, must have been melted in the first 30 minutes, namely, $690\frac{1}{2}$ grains, there will remain $3272\frac{1}{2}$ grains for the quantity melted in the last 150 minutes, which gives $654\frac{1}{2}$ grains for the quantity melted in 30 minutes *in the ordinary course of the experiment*.

This quantity, $654\frac{1}{2}$ grains, deducted from that which at a mean of two experiments (those No. 34 and No. 35) was found to be actually melted in 30 minutes, namely, $690\frac{1}{2}$ grains, leaves 36 grains for the quantity which in these two experiments was melted in consequence of the temporary motions into which the hot water was thrown in the operation of pouring it into the jar. The difference between these two quantities ($= 36$ grains) is very inconsiderable, and shews that the means

used for diminishing the effects produced by those motions had been very efficacious.

As the results of the three experiments No. 34, No. 35, and No. 36, were exceedingly regular and satisfactory, — as the Heat of the water appears to have been so completely confined by the warm covering which surrounded the jar, and as the process of melting the ice went on regularly or equally for so great a length of time (three hours) in the 36th experiment, we may venture to conclude that more ice could not possibly have been melted by boiling-hot water — *standing on it* — than was melted in these experiments.

This quantity was found to be at the rate of $654\frac{1}{2}$ grains in 30 minutes.

But as in these experiments extraordinary means were used, by which an uncommonly large quantity of ice was melted, they cannot be considered as similar to those which were made with cold water, and consequently cannot with propriety be compared with them.

When the experiments were similar, the mean results of those which were made with water at different temperatures were as follows.

		Ice melted in 30 minutes.
		Grains.
In the experiments in which the part of the jar which was occupied by the water was exposed uncovered to the air at the temperature of 61°	With boiling-hot water (experiments No. 39, 40, and 41)	558 $\frac{2}{3}$
	With water at the temperature of 61° (experiments No. 53 and No. 54)	646
	With water at the temperature of 41° (experiments No. 42 and No. 43)	574
In the experiments in which the part of the jar which was occupied by the water was surrounded by pounded ice and water, and consequently was at the temperature of 32°	With boiling-hot water (experiments No. 45, 46, 47, 48, and 49)	399 $\frac{2}{3}$
	With water at the temperature of 61° (experiments No. 51 and No. 52)	661
	With water at the temperature of 41° (experiment No. 50)	542

From the results of all these experiments we may certainly venture to conclude that boiling-hot water is not capable of melting more ice, *when standing on its surface*, than an equal quantity of water at the temperature of 41°, or when it is only *nine degrees* above the temperature of freezing!

This fact will, I flatter myself, be considered as affording the most unquestionable proof that could well be imagined, that water is a perfect *non-conductor of Heat*, and that Heat is propagated in it *only* in consequence of the motions which the Heat occasions in the insulated and solitary particles of that fluid.*

* The insight which this discovery gives us in regard to the nature of the mechanical process which takes place in chemical solutions is too evident to require illustration; and it appears to me that it will enable us to account in a satisfactory manner for all the various phenomena of chemical affinities and vegetation. Perhaps all the motions among inanimate bodies on the surface of the globe may be traced to the same cause, — namely, to the non-conducting power of Fluids with regard to Heat.

The discovery of this fact opens to our view one of the most interesting scenes in the economy of Nature: but in order to prepare our minds for the contemplation of it, it will be not amiss to refresh our memory by recapitulating what has already been said on the Propagation of Heat in Fluids, and particularly in water; and adding such occasional observations as may tend to elucidate that abstruse subject.

Those who enter into the spirit of these investigations will not consider these repetitions and illustrations as either superfluous or tiresome.

CHAPTER III.

Recapitulation, and farther Investigation of the Subject. — All Bodies are condensed by Cold without Limitation, WATER ONLY EXCEPTED. — Wonderful Effects produced in the World in consequence of the particular Law which obtains in the Condensation of Water. — This Exception to one of the most general Laws of Nature, a striking Proof of Contrivance in the Arrangement of the Universe; a Proof which comes home to the Feelings of every ingenuous and grateful Mind. — This particular Law does not obtain in the Condensation of SALT WATER. — Final Cause of the Saltness of the Sea. — The Ocean probably designed by the Creator to serve as an Equalizer of Heat. — Could not have answered that Purpose had its Waters been fresh. — Final Cause of the Freshness of Lakes and inland Seas in high Latitudes. — Usefulness of these Speculations.

AS the immediate cause of the motions in a liquid, which take place on its undergoing a change of

temperature, is evidently the change in the specific gravity of those particles of the liquid which become either hotter or colder than the rest of the mass, and as the specific gravities of some liquids are much more changed by any given change of temperature than those of others, ought not this circumstance (independent of the more or less perfect fluidity of the liquid) to make a sensible difference in the conducting power of liquids?

The more a liquid is expanded by any given change of temperature, the more rapid will be the ascent of the particles which first receive the Heat; and as these are immediately replaced by other colder particles, which, in their turns, come to be heated, this must of course produce a rapid communication of Heat from the hot body of the liquid.

But when, on the other hand, the specific gravity of a liquid is but little changed by any given change of temperature, the motions among the particles of the liquid occasioned by this change must be very sluggish, and the communication of Heat of course very slow.

Let us stop here for one moment just to ask ourselves a very interesting question. Suppose that in the general arrangement of things it had been necessary to contrive matters so that water should not freeze in winter, or that it should not freeze *but with the greatest difficulty*, — very slowly, *and in the smallest quantity possible*. How could this have been most readily effected?

Those who are acquainted with the law of the condensation of Water on parting with its Heat have already anticipated me in these speculations; and it does not appear to me that there is anything which human sagacity can fathom, within the wide-extended bounds of the visible creation, which affords a more striking or more

palpable proof of the wisdom of the Creator, and of the special care he has taken in the general arrangement of the universe to preserve animal life, than this wonderful contrivance ; for though the extensiveness and immutability of the general laws of Nature impress our minds with awe and reverence for the Creator of the universe, yet *exceptions to those laws*, or particular modifications of them, from which we are able to trace effects evidently *salutary* or advantageous to ourselves and our fellow-creatures, afford still more striking proofs of contrivance, and ought certainly to awaken in us the most lively sentiments of admiration, love, and gratitude.

Though in temperatures above blood-heat the expansion of water with Heat is very considerable, yet in the neighbourhood of the freezing point it is almost nothing. And what is still more remarkable, as it is an exception to one of the most general laws of Nature with which we are acquainted, when in cooling it comes within eight or nine degrees of Fahrenheit's scale of the freezing point, instead of going on to be farther condensed as it loses more of its Heat, it *actually expands* as it grows colder, and continues to expand more and more as it is more cooled.

If the whole amount of the condensation of any given quantity of boiling-hot water, on being cooled to the point of freezing, be divided into any given number of equal parts, the condensations corresponding to equal changes of temperature will be very unequal in different temperatures.

In cooling $22\frac{1}{2}$ degrees of Fahrenheit's scale (or one-eighth part of the interval between the boiling and the freezing points) the condensation will be, —

				Condensation.
In cooling $22\frac{1}{2}^{\circ}$, viz. from	212°	to	$189\frac{1}{2}^{\circ}$	18 parts.
	$189\frac{1}{2}$	“	167	16.2 “
	167	“	$144\frac{1}{2}$	13.8 “
	$144\frac{1}{2}$	“	122	11.5 “
	122	“	$99\frac{1}{2}$	9.3 “
	$99\frac{1}{2}$	“	77	7.1 “
	77	“	$54\frac{1}{2}$	3.9 “
	$54\frac{1}{2}$	“	32	0.2 “

Hence it appears that the condensation of water, or increase of its specific gravity in being cooled $22\frac{1}{2}$ degrees of Fahrenheit's scale, is at least *ninety times greater* when the water is boiling-hot, than when it is at the mean temperature of the atmosphere in England ($54\frac{1}{2}^{\circ}$), or within $22\frac{1}{2}$ degrees of freezing, (for 18 is to 0.2 as 90 to 1.)

All liquids, it is true, in cooling, are more condensed by any given change of temperature when they are very hot than when they are colder; but these differences are nothing compared to those we observe in water.

The ratio of the condensation in cooling from 212° to $189\frac{1}{2}^{\circ}$ to that in cooling from $54\frac{1}{2}^{\circ}$ to 32° in each of the under-mentioned fluids has been shown, by the experiments of M. de Luc, to be as follows: —

Olive-oil	as	$1\frac{14}{100}$	to	1
Strong spirits of wine	as	$1\frac{29}{100}$	to	1
A saturated solution of sea-salt in water	as	$1\frac{38}{100}$	to	1
Pure water	as	90	to	1

The difference between the laws of the condensation of pure water and of the same fluid when it holds in solution a portion of salt is striking; but when we trace *the effects* which are produced in the world by that arrangement, we shall be lost in wonder and admiration.

Let me beg the attention of my reader while I endeavour to investigate this most interesting subject, and let me at the same time bespeak his candour and indulgence. I feel the danger to which a mortal exposes himself who has the temerity to undertake to explain the designs of Infinite Wisdom. The enterprise is adventurous, but it cannot surely be improper.

The wonderful simplicity of the means employed by the Creator of the world to produce the changes of the seasons, with all the innumerable advantages to the inhabitants of the earth which flow from them, cannot fail to make a very deep and a lasting impression on every human being whose mind is not degraded, and quite callous to every ingenuous and noble sentiment; but the farther we pursue our inquiries respecting the constitution of the universe, and the more attentively we examine the effects produced by the various modifications of the active powers which we perceive, the more we shall be disposed to admire, adore, and love that great First Cause which brought all things into existence.

Though winter and summer, spring and autumn, and all the variety of the seasons, are produced in a manner at the same time the most simple and the most stupendous (by the inclination of the axis of the earth to the plane of the ecliptic), yet this mechanical contrivance alone would not have been sufficient (as I shall endeavour to show) to produce that gradual change of temperature in the various climates which we find to exist, and which doubtless is indispensably necessary to the preservation of animal and vegetable life.

Though change of temperature seems necessary to the growth and perfection of most vegetables, yet these changes must be within certain limits. Some plants can

support greater changes of temperature than others, but the extremes of Heat and of Cold are alike fatal to all.

As the rays of the sun are the immediate cause of the Heat on the surface of the globe, and as the length of the days in high latitudes is so very different in summer and in winter, it is evident that, in order to render those regions habitable, some contrivance was necessary to prevent the consequences which this great inequality of the Heat generated by the sun in summer and in winter would naturally tend to produce ; or, in other words, to equalize the Heat, and moderate its extremes in these two seasons.

Let us see how far *Water* is concerned in this operation, and then let us examine how far the remarkable law which has been found to obtain in its condensation by cold tends to render it well adapted to answer that most important purpose.

The vast extent of the ocean, and its great depth, but still more its numerous currents, and the power of water to absorb a vast quantity of Heat, render it peculiarly well adapted to serve as an equalizer of Heat.

On the retreat of the sun after the solstice, it is closely followed by the cold winds from the regions of eternal frost, which are continually endeavouring to press in towards the equator. As the power of the sun to warm the surface of the earth and the air diminishes very fast in high latitudes on the days growing shorter, it soon becomes too weak to keep back the dense atmosphere which presses on from the polar regions, and the cold increases very fast.

There is, however, a circumstance by which these rapid advances of winter are in some measure moderated. The earth, but more especially the *water*, having imbibed

a vast quantity of Heat during the long summer days, while they receive the influence of the sun's vivifying beams; this Heat, being given off to the cold air which rushes in from the polar region, serves to warm it and soften it, and consequently to diminish the impetuosity of its motion, and take off the keenness of its blast. But as the cold air still continues to flow in as the sun retires, the accumulated Heat of summer is soon exhausted, and all solid and fluid bodies are reduced to the temperature of freezing water. In this stage the cold in the atmosphere increases very fast, and would probably increase still faster, were it not for the vast quantity of Heat which is communicated to the air by the watery vapours which are first condensed, and then congealed, in the atmosphere, and which afterwards fall upon the earth in the form of snow; and by that still larger quantity which is given off by the water in the rivers and lakes, and in the ground upon its being frozen.

But in very cold countries the ground is frozen and covered with snow, and all the lakes and rivers are frozen over in the very beginning of winter. The cold then first begins to be extreme, and there appears to be no source of Heat left, which is sufficient to moderate it in any sensible degree.

Let us see what must have happened if things had been left to what might be called their natural course, — if the condensation of water on being deprived of its Heat had followed the law which we find obtains in other fluids, and even in water itself in some cases, namely, when it is mixed with certain bodies.

Had not Providence interfered on this occasion in a manner which may well be considered as *miraculous*, all

the fresh water within the polar circle must inevitably have been frozen to a very great depth in one winter, and every plant and tree destroyed; and it is more than probable that the regions of eternal frost would have spread on every side from the poles, and, advancing towards the equator, would have extended its dreary and solitary reign over a great part of what are now the most fertile and most inhabited climates of the world!

In latitudes where now the return of spring is hailed by the voice of gladness, where the earth decks herself in her gayest attire, and millions of living beings pour forth their songs of joy and gladness, nothing would have been heard but the whistling of the rude winds, and nothing seen but ice and snow, and flying clouds charged with wintry tempests.

Let us, with becoming diffidence and awe, endeavour to see what the means are which have been employed by an almighty and benevolent God to protect his fair creation.

As nourishment and life are conveyed to all living creatures through the medium of water, — *liquid, living* water, — to preserve life, it was absolutely necessary to preserve a great quantity of water in a fluid state in winter as well as in summer.

But in cold climates the temperature of the atmosphere, during many months in the year, is so much below the freezing point, that, had not measures been taken to prevent so fatal an accident, all the water must inevitably have been changed to ice, which would infallibly have caused the destruction of every living thing.

Extraordinary measures were therefore necessary for preserving in a liquid state as much of the water existing in those climates as is indispensably necessary for the

preservation of vegetable and animal life; and this could only be done by contriving matters so as to prevent this water from parting with its Heat to the cold atmosphere.

It has been shown, I believe I may venture to say proved, in the most satisfactory manner, that liquids part with their Heat ONLY in consequence of their internal motions; and that the more rapid these motions are, the more rapid is the communication of the Heat; that these motions are produced by the change in the specific gravity of the liquid, occasioned by the change of temperature; and of course that they are more rapid, as the specific gravity of the liquid is the more changed by any given change of temperature.

But it has been shown that the change in the specific gravity of water is extremely small, which takes place in any given change of temperature, *below the mean temperature of the atmosphere*, and particularly when the temperature of the water is very near the freezing point; and hence it follows that water must give off its Heat very slowly when it is near freezing.

But this is not all. There is a still more extraordinary, and in its consequences more wonderful, circumstance which remains to be noticed. When water is cooled to within eight or nine degrees of the freezing point, it not only ceases to be farther condensed, but is actually expanded by farther diminutions of its Heat; and this expansion goes on as the Heat is diminished, as long as the water can be kept fluid; and when it is changed to ice it expands even still more, and the ice floats on the surface of the uncongealed part of the Fluid.

Let us see how very powerfully this wonderful contriv-

ance tends to retard the cooling of water when it is exposed in a cold atmosphere.

It is well known that there is no communication of Heat between two bodies as long as they are both at the same temperature ; and it is likewise known that the *tendency* of Heat to pass from a hot body into one which is colder, with which it is in contact, is greater, as the difference is greater in the temperature of the two bodies.

Suppose now that a mass of very cold air reposes on the quiet surface of a large lake of fresh water at the temperature of 55° of Fahrenheit's thermometer. The particles of water at the surface, on giving off a part of their Heat to the cold air with which they are in contact, and in consequence of this loss of Heat becoming specifically heavier than those hotter particles on which they repose, must of course descend. This descent of the particles which have been cooled necessarily forces other hotter particles to the surface, and these being cooled in their turns bend their course downwards ; and the whole mass of water is put into motion, and continues in motion as long as the process of cooling goes on.

Before I proceed to trace this operation through all its various stages, I must endeavour to remove an objection which may perhaps be made to my explanation of this phænomenon. As I have supposed the mass of air which rests on the surface of the water to be *very cold*, and as I have taken it for granted that there is no communication whatever of Heat between the particles of water in contact with this very cold air and the neighbouring warmer particles of water, it may be asked how it happens that these particles at the surface are not so much cooled as to be immediately changed to ice. To

this I answer, that there are two causes which conspire to prevent the *immediate* formation of ice at the surface of the water: *First*, the specific gravity of the particle of water at the surface being increased at the same moment when it parts with Heat, it begins to descend as soon as it begins to be cooled, and before the air has had time to rob it of all its Heat, it escapes and gets out of its reach; and, *secondly*, air being a bad conductor of Heat, it cannot receive and transmit or *transport it* with sufficient celerity to cool the surface of water so suddenly as to embarrass the motions of the particles of that liquid in the operation of giving it off.

But to return to our lake. As soon as the water in cooling has arrived at the temperature of about 40° , as at that temperature it ceases to be farther condensed, its internal motion ceases, and those of its particles which happen to be at its surface remain there; and, after being cooled down to the freezing point, they give off their latent Heat, and ice begins to be formed.

As soon as the surface of the water is covered with ice, the communication of Heat from the water to the atmosphere is rendered extremely slow and difficult; for ice being a *bad conductor of Heat* forms a very warm covering to the water, and moreover it prevents the water from being agitated by the wind. Farther, as the temperature of the ice at its lower surface is always very nearly the same as that of the particles of liquid water with which it is in contact (the warmer particles of this Fluid, in consequence of their greater specific gravity, taking their places below), the communication of Heat between the water and the ice is necessarily very slow on that account.

As soon as the upper surface of the ice is covered

with snow (which commonly happens soon after the ice is formed), this is an additional and very powerful obstacle to prevent the escape of the Heat out of the water; and though the most intense cold may reign in the atmosphere, the increase of the thickness of the ice will be very slow.

During this time the mass of water which remains unfrozen will lose *no part of its Heat*; on the contrary, it will continually be receiving Heat from the ground. This Heat, which is accumulated in the earth during the summer, will not only serve, in some measure, to replace that which is communicated to the atmosphere through the ice, and prevent its being furnished at the expence of the latent Heat of the water in contact with its surface, but when the temperature of the air is not much below that of freezing, this supply of Heat from below will be quite sufficient to replace that which the air carries off; and the thickness of the ice will not increase.

Whenever the temperature of the air is not actually *colder* than freezing water, the Heat which rises from the bottom of the lake will be all employed in melting the ice at its under surface, and diminishing its thickness.

It will indeed frequently happen, when the ice is very thick, and especially when its upper surface is covered with deep snow, that the melting of the ice at its under surface will be going on, when the temperature of the atmosphere is considerably below the freezing point.

As the particles of water which, receiving Heat from the ground at the bottom of the lake, acquire a higher temperature than that of 40° , and being *expanded*, and becoming specifically lighter by this additional Heat, rise up to the upper surface of the fluid water, and give

off their sensible Heat to the under surface of the ice, never return to the bottom, this communication of the Heat which exhales from the earth produces very little motion in the mass of the water; and this circumstance is, no doubt, very favourable to the preservation of the Heat of the water.

When a strong wind prevails, and the surface of the water is much agitated, ice is not formed, even though the whole mass of water should, by a long continuance of cold weather, have been previously cooled down to that point to which it is necessary that it should be brought, in order that its internal motions may cease, and it may be disposed to congeal; for though the particles at and near the surface may no longer have any tendency to descend, on being farther cooled, yet, as they have so considerable a quantity of sensible Heat (eight or ten degrees) to dispose of, after their condensation with cold ceases, and as the agitation into which the water is thrown by the wind does not permit any particle to remain long enough in contact with the cold air to give off all its Heat at once, there is a continual succession of fresh particles at the surface, all of which give off Heat to the air; but none of them have time to be cooled sufficiently to be disposed to form ice. The water will lose a vast quantity of Heat, and as soon as the wind ceases, if the cold should continue, ice will be formed very rapidly.

But it is not merely the agitation of the water which renders the communication of the Heat very rapid, the agitation of the wind also tends to produce the same effect.

On the return of spring, the snow melting before the sun as he advances and his rays become more powerful,

all the Heat which the earth exhales is employed in dissolving the ice at its under surface, while the sun on the other side acts still more powerfully to produce the same effect.

Though ice is transparent, yet it is not perfectly so; and as the light which is stopped in its passage through it cannot fail to generate Heat *when* and *where* it is stopped or absorbed, it is by no means surprising that snow should be found to melt when exposed in the sun's rays, even when the temperature of the air in the shade is considerably below the point of freezing. Snow exposed to the sun melts long before the even surface of ice begins to be sensibly softened by its beams, and it is not till some time after all the hills are bare that the ice on the lakes and rivers breaks up.

The rays which penetrate a bank of snow, being often reflected and refracted, descend deep into it, and the Heat is deposited in a place where it is not exposed to be carried off by the cold air of the atmosphere; but the rays which fall upon the horizontal and smooth surface of ice are mostly reflected upwards into the atmosphere; and if any part of them are stopped at the surface of the ice, the Heat generated by them *there* is instantaneously carried off by the cold air, and a particle of water is no sooner made fluid than it is again frozen.

Hence we see that the snow which in cold countries covers the ice that is formed on the surface of fresh water not only prevents the Heat of the water from being carried off by the air during the winter, but also assists very powerfully in thawing the ice early in the spring.

Should the waters of a lake be so deep, or so imperfectly transparent as to intercept a great proportion of rays of the sun before they reach the bottom, in that

case, the temperature of the water at the bottom of the lake will be *nearly the same all the year round*; and in countries where there is *any* frost in winter, and particularly in those lakes which lie near high mountains, and are fed by torrents which proceed from *Glaciers*, and melting snow, this *constant temperature* at the bottom can never be much above or below 41° F., whatever may be the Heat to which the *surface* of the lake is exposed in summer, or however long and intensely hot the summer may be.*

Let us now see what the consequences would have been, had the condensation of water with cold followed the law which obtains in regard to all other fluids.

As the internal motion of the water could not have failed to continue as long as its specific gravity continued to be increased by parting with Heat, ice would not have begun to be formed till the whole mass of water had arrived at the temperature of 32° of Fahrenheit's thermometer.

To see what an enormous quantity of Heat would be

* In a letter from Professor Pictet, of Geneva, to the Author, of the 7th July, 1797, accompanying the 36th number of the BIBLIOTHÈQUE BRITANNIQUE (in which an account, or rather translation, of the first Edition of this Essay is published in the French language), there is the following paragraph:—

"I took the liberty to throw in, as usual," (in the translation,) "some occasional notes; one of which will, I hope, deserve your attention. It points out the near coincidence of the mean temperature of the bottom, observed in ten different lakes, by M. de Saussure and myself, viz. $4\frac{1}{2}^{\circ}$ R. (equal to $41\frac{3}{4}^{\circ}$ F.) with the temperature where the *minimum* of volume, or *maximum* of density, of water takes place. We vainly strove to this day to explain the uniformity we observed in that particular in several lakes very differently situated in many respects, but your reflections seem to me fully to resolve the problem."

The following is the note in the *Bibliothèque Britannique*, alluded to by Professor Pictet in the foregoing paragraph of his letter:—

"Ce n'est pas seulement dans le lac de Genève que M. de Saussure, notre savant ami, a fait les expériences curieuses qui sont ici rappelées, et à quelques-unes des quelles nous avons eu le plaisir d'assister; il les a répétées dans la Méditerranée, et dans dix lacs qui bordent de part et d'autre la chaîne des Alpes. Nous tirons de

lost when the water is deep in consequence of its whole mass being cooled in this manner, we have only to compute how much ice this Heat would melt, or how much water it would heat from the point of freezing to that of boiling.

It has been shown by experiment, that any given quantity of ice requires as much Heat to melt it as an equal quantity of fluid water loses in cooling 140 degrees; consequently, the quantity of ice which might be melted by the Heat given off by any given quantity of water in cooling any given number of degrees is to the given quantity of water as the number of degrees which it is cooled to 140 degrees.

Hence it follows that when the temperature of the water is 8 degrees above the freezing point, it gives off

son grand ouvrage sur les montagnes les températures observées au fond de ces lacs comme suit : —

Noms des Lacs.	Profondeurs en pieds de France.	Températures du fond Degrés de Reamur.
“Lac de Genève	950	4.3
“ de Neuchâtel	325	4.1
“ de Bienne	217	5.5
“ du Bourget	240	4.5
“ d’Annecy	163	4.5
“ de Thun	350	4.0
“ de Brientz	500	3.8
“ de Lucerne	600	3.9
“ de Constance	370	3.4
Lac Majeur	335	5.4
Température moyenne du fond de dix lacs		4.34, ou 4½° R.”

“Il n’est peut-être aucun de nos lecteurs qui, plein des idées que notre auteur vient de discuter, ne soit frappé de la coïncidence entre cette température du fond des lacs dans nos latitudes moyennes et celle à laquelle l’eau atteint son *minimum* de volume ou *maximum* de densité ! La permanence de cette température, et son identité dans des lacs d’ailleurs très-diversement situés, paroissent intimement liées avec cette circonstance du *minimum* de volume. Mais ce n’est pas ici le lieu de donner cours aux idées que peut suggérer ce rapprochement ; nous l’indiquons à l’auteur comme un objet digne de ses méditations.”

The Author of this Essay feels himself very much obliged to his ingenious and respectable friend, Professor Pictet, for these interesting observations.

in cooling down to that temperature as much Heat as would melt $\frac{8}{140}$ or $\frac{2}{35}$ of its weight of ice; the water, therefore, which is cooled from the temperature of 40° to that of 32° , if it be 35 feet deep, will give off as much Heat in being so cooled as would melt a covering of ice 2 feet thick.

But this even is not all; for as the particles of water on being cooled at the surface would, in consequence of the increase of their specific gravity on parting with a portion of their Heat, immediately descend to the bottom, the greatest part of the Heat accumulated during the summer in the earth on which the water reposes would be carried off and lost before the water began to freeze; and when ice was once formed, its thickness would increase with great rapidity, and would continue increasing during the whole winter; and it seems very probable, that, in climates which are now temperate, the water in the large lakes would be frozen to such a depth in the course of a severe winter that the Heat of the ensuing summer would not be sufficient to thaw them; and should this once happen, the following winter could hardly fail to change the whole mass of its waters to one solid body of ice, which never more could recover its liquid form, but must remain immovable till the end of time.

In the month of February, after a frost which had lasted a month, the temperature of the air being 38° , M. de Saussure found the temperature of the water of the Lake of Geneva, at the surface, at 41° , and at the depth of 1000 feet at 40° . Had the frost continued but a little longer, ice would have been formed; but had the constitution of water been such that the whole mass of that fluid in the lake must have been cooled down to the

temperature of 32° before ice could have been formed, this event could not have happened till the water had given off as much Heat as would be sufficient to melt a covering of ice above 57 feet thick !

This quantity of Heat would be sufficient to heat, to the point of boiling, a quantity of ice-cold water as large as the lake, and 49 feet deep.

We cannot sufficiently admire the simplicity of the contrivance by which all this Heat is saved. It well deserves to be compared with that by which the seasons are produced ; and I must think that every candid enquirer who will begin by divesting himself of all unreasonable prejudices will agree with me in attributing them both TO THE SAME AUTHOR.

When we trace still farther the astonishing effects which are produced in the world by the operations of that simple law which has been found to obtain in the condensation of water on its being deprived of Heat, we shall find more and more reason to admire the wisdom of the contrivance.

That high latitudes might be habitable, it was necessary that vegetables should be protected from the effects of the chilling frosts of a long and severe winter ; but if it be true that watery liquids do not part with their Heat but in consequence of their internal motions, and if these motions are occasioned merely by the change produced in the specific gravity of those particles of the liquid which receive Heat, or which part with it, who does not see how very powerfully the sudden diminution and final cessation of the condensation of water in cooling, as soon as its temperature approaches to the freezing point, operates to prevent the sap in vegetables from being frozen ?

But if, for the purposes of life and vegetation, it be necessary that the ground, the rivers, the lakes, and the trees be defended from the cold winds from the poles, it may be asked how this inundation of cold air is to be warmed? I answer by the waters of the ocean, which there is the greatest reason to think were not only designed principally for that use, but particularly *prepared* for it.

Sea water contains a large proportion of salt in solution; and we have seen that the condensation of a saline solution, on its being cooled, follows a law which is extremely different from that observed in regard to pure water; and which (as may easily be shown) renders it peculiarly well adapted for communicating Heat to the cold winds which blow over its surface.

As sea water continues to be condensed as it goes on to cool, even after it has passed the point at which fresh water freezes, the particles at the surface, instead of remaining there after the mass of the water had been cooled to about 40° , and preventing the other warmer particles below from coming in their turns and giving off their Heat to the cold air (as we have seen always happens when fresh or pure water is so cooled), these cooled particles of *salt water* descend as soon as they have parted with their Heat, and in moving downward force other warmer particles to move upwards; and in consequence of this continual succession of warm particles which come to the surface of the sea, a vast deal of Heat is communicated to the air, — incomparably more than could possibly be communicated to it by an equal quantity of fresh water at the same temperature, as will appear by the following computation.

Without taking into the account that very great ad-

vantage which sea water possesses over fresh water, considered as an equalizer of the temperature of the atmosphere, which arises from the comparative *lowness of the point of its congelation*; supposing even sea water to freeze at as high a temperature as fresh water, namely, at 32° ; and supposing (what is strictly true) that as soon as either sea water or fresh water is frozen at its surface, and this ice covered with snow, the communication of Heat from the water to the atmosphere ceases almost entirely, — we will endeavour to determine how much more Heat would, even on this supposition, be communicated to the air by salt water than by fresh water, after both have arrived at the temperature of 40° .

When fresh water, in cooling, has arrived at this temperature, it ceases to be farther condensed with cold, and its internal motions (which, as we have already more than once observed, are caused *solely* by the changes produced in the specific gravity of its particles) cease, of course, and ice immediately begins to be formed on its surface; but as the condensation of salt water goes on as its Heat goes on to be diminished, its internal motions will continue; and it is evidently impossible for ice to be formed at its surface till the whole mass of the water has become ice-cold, or till its temperature is brought down to 32° . It would therefore give off a quantity of Heat equal to 8 degrees, at least, of Fahrenheit's thermometer, *more than the fresh water* would part with before ice could be formed on its surface.

To be able to form an idea of this enormous quantity of Heat, we have only to recollect what has already been said, and we shall find reason to conclude that it would be sufficient to melt a covering of ice equal in thickness to $\frac{2}{36}$ of the depth of the sea. It would therefore be suffi-

cient in that part of the North Sea (lat. 67°) where Lord Mulgrave sounded at the depth of 4680 feet, to melt a cake of ice 265 feet thick !

But the Heat evolved in the formation of each superficial foot of ice would be sufficient to raise the temperature of a stratum of incumbent air 2220 times as thick as the ice (consequently, in the case in question, 265×2220 feet, or 869 miles thick) 28 degrees, or from the temperature of freezing water to that of 50° of Fahrenheit's thermometer, or to the mean annual temperature of the northern parts of Germany !

The Heat given off to the air by each superficial foot of water in cooling *one degree* is sufficient to heat an incumbent stratum of air 44 times as thick as the depth of the water 10 degrees. Hence we see how very powerfully the water of the ocean, which is never frozen over, except in very high latitudes, must contribute to warm the cold air which flows in from the polar regions.

But the ocean is not more useful in moderating the extreme cold of the polar regions than it is in tempering the excessive heats of the torrid zone ; and what is very remarkable, the fitness of the sea water to serve this last important purpose is owing to the very same cause which renders it so peculiarly well adapted for communicating Heat to the cold atmosphere in high latitudes, namely, *to the salt which it holds in solution.*

As the condensation of salt water with cold continues to go on even long after it has been cooled to the temperature at which fresh water freezes, those particles at the surface which are cooled by an immediate contact with the cold winds must descend, and take their places at the bottom of the sea, where they must remain, till, by acquiring an additional quantity of Heat, their spe-

cific gravity is again diminished. But this Heat *they never can regain in the polar regions*; for innumerable experiments have proved, beyond all possibility of doubt, that there is no *principle of Heat* in the *interior parts of the globe*, which, by exhaling through the bottom of the ocean, could communicate Heat to the water which rests upon it.

It has been found that the temperature of the earth at great depths under the surface is different in different latitudes, and there is no doubt but this is also the case with respect to the temperature at the bottom of the sea, in as far as it is not influenced by the currents which flow over it; and this proves to a demonstration that the Heat which we find to exist, without any sensible change during summer and winter, at great depths, is owing to the action of the sun, and not to *central fires*, as some have too hastily concluded.

But if the water of the ocean, which, on being deprived of a great part of its Heat by cold winds, descends to the bottom of the sea, cannot be warmed *where it descends*, as its specific gravity is greater than that of water at the same depth in warmer latitudes, it will immediately begin to spread on the bottom of the sea, and to flow towards the equator, and this must necessarily produce a current at the surface in an opposite direction; and there are the most indubitable proofs of the existence of both these currents.

The proof of the existence of one of them would indeed have been quite sufficient to have proved the existence of both, for one of them could not possibly exist without the other; but there are several direct proofs of the existence of each of them.

What has been called the Gulf Stream in the Atlantic

Ocean is no other than one of these currents, — that at the surface, which moves from the equator towards the north pole, modified by the trade winds and by the form of the continent of North America; and the progress of the lower current may be considered as proved directly by the cold which has been found to exist in the sea at great depths in warm latitudes, — a degree of temperature much below the mean annual temperature of the earth in the latitudes where it has been found, and which of course must have been *brought from colder latitudes*.

The mean annual temperature in the latitude of 67° has been determined by Mr. Kirwan, in his excellent treatise on the temperature of different latitudes, to be 39° ; but Lord Mulgrave found on the 20th of June, when the temperature of the air was $48\frac{1}{2}^{\circ}$, that the temperature of the sea at the depth of 4680 feet was 6 degrees below freezing, or 26° of Fahrenheit's thermometer.

On the 31st of August, in the latitude of 69° , where the annual temperature is about 38° , the temperature of the sea at the depth of 4038 feet was 32° ; the temperature of the atmosphere (and probably that of the water at the surface of the sea) being at the same time at $59\frac{1}{2}^{\circ}$.

But a still more striking, and I might, I believe, say an incontrovertible proof of the existence of currents of cold water at the bottom of the sea, setting from the poles towards the equator, is the very remarkable difference that has been found to subsist between the temperature of the sea at the surface and at great depths, at the tropic; though the temperature of the atmosphere there is so constant that the greatest change produced in it by the seasons seldom amounts to more than five or six degrees, yet the difference between the Heat of the water

at the surface of the sea, and that at the depth of 3600 feet has been found to amount to no less than 31 degrees; the temperature above or at the surface being 84° , and at the given depth below no more than 53° .*

It appears to me to be extremely difficult, if not quite impossible, to account for this degree of cold at the bottom of the sea in the torrid zone on any other supposition than that of cold currents from the poles; and the utility of these currents in tempering the excessive heats of those climates is too evident to require any illustration.

These currents are produced, as we have already seen, in consequence of the difference in the specific gravity of the sea water at different temperatures; their velocities must therefore be in proportion to the change produced in the specific gravity of water by any given change of temperature; and hence we see how much greater they must be in salt water than they could possibly have been had the ocean been composed of fresh water.

It is not a little remarkable that the water of all great lakes is fresh, and nearly so in all inland seas (like the Baltic) in cold climates, and which communicate with the ocean by narrow channels. We shall find reason to conclude that this did not happen without design, when we consider what consequences would probably ensue should the waters of a large lake in an inland situation, in a cold country (such as the lake Superior, for instance, in North America), become as salt as the sea.

Though the cold winds which blow over the lake in the beginning of winter would be more warmed, and the temperature of the air on the side of the lake opposite to the quarter from whence these winds arrive would be rendered somewhat milder than it now is; yet, as the

* Phil. Transactions, 1752.

water of the lake would give off an immense quantity of Heat before a covering of ice could be formed on its surface for its protection, it would, on the return of spring, be found to be *extremely cold*; and as it would require a long time to regain from the influence of the returning sun the enormous quantity of Heat lost during the winter, it would remain very cold during the spring, and probably during the greatest part of the summer; and this could not fail to chill the atmosphere, and check vegetation in the surrounding country to a very considerable distance. And though a large lake of salt water in a cold country would tend to render the winter *somewhat milder* on one side of it, namely, on the side opposite to the quarter from whence the cold winds came; yet this advantage would not only be confined to a small tract of country, but would not anywhere be very important, and would by no means counterbalance the extensive and fatal consequences which would be produced in summer by so large a collection of very cold water.

When the winter is once fairly set in, — when the earth is well covered with snow, and the rivers and lakes with ice, and more especially when the ice as well as the land is covered with that warm winter garment, a few degrees more of cold in the air cannot produce any lasting bad consequences. It may oblige the inhabitants to use additional precautions to guard themselves, their domestic animals, and their provisions from the uncommon severity of the weather; but it can have very little influence in the temperature of the ensuing summer; and even it is probable, if it influences it at all, that it tends rather to make it *warmer* than *colder*. Lakes of salt water could therefore be of no real use *in winter* in cold

countries, and in summer they could not fail to be very hurtful; while fresh lakes, as they are frozen over almost as soon as the winter sets in, and long before the whole mass of their water is cooled down to the temperature of freezing, preserve the greater part of their Heat through the winter, and if they are of no use during the cold season, they probably do little or no harm in summer.

But I must take care not to tire my reader by pursuing these speculations too far. If I have persisted in them, if I have dwelt on them with peculiar satisfaction and complacency, it is because I think them uncommonly interesting, and also because I conceived that they might be of real use in this age of *refinement* and *scepticism*.

If, among barbarous nations, the *fear of a God*, and the practice of religious duties, tend to soften savage dispositions, and to prepare the mind for all those sweet enjoyments which result from peace, order, industry, and friendly intercourse, — a *belief in the existence of a Supreme Intelligence*, who rules and governs the universe with wisdom and goodness, is not less essential to the happiness of those who, by cultivating their mental powers, HAVE LEARNED TO KNOW HOW LITTLE CAN BE KNOWN.

DESCRIPTION OF THE PLATES.

PLATE I.

THIS Plate represents the cylindrical Passage Thermometer used in the experiments on the conducting power of liquids with regard to Heat.

Fig. 1. *a, b*, is a section of the brass tube in which the Thermometer *c*, with an oblong copper bulb, is placed.

e, f, is the glass tube of the thermometer, which, for want of room in the Plate, is represented as broken off at *f*.

g, is a stopple of cork by which the end of the brass tube, *a, b*, is closed; and

h, is a circular disk of the same substance.

The space in the brass tube below this disk *h*, surrounding the bulb of the thermometer, was occupied by the liquid whose conducting power was determined. The space between the disk and the cork-stopper *g*, was filled with eider-down.

Between the inside of the brass tube and the lower part of the bulb of the thermometer are seen the wooden pins which served to confine the thermometer in its place.

Fig. 2. This is an horizontal section of the brass tube, and a bird's-eye view of the thermometer in its place.

PLATE II.

Fig. 3. This Figure shows the manner in which the experiments were made, in which a cake of ice at the

Fig 1.

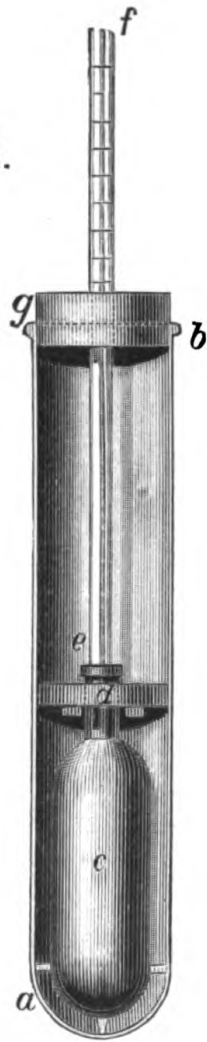
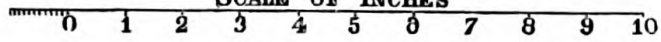

Fig. 2.



SCALE OF INCHES



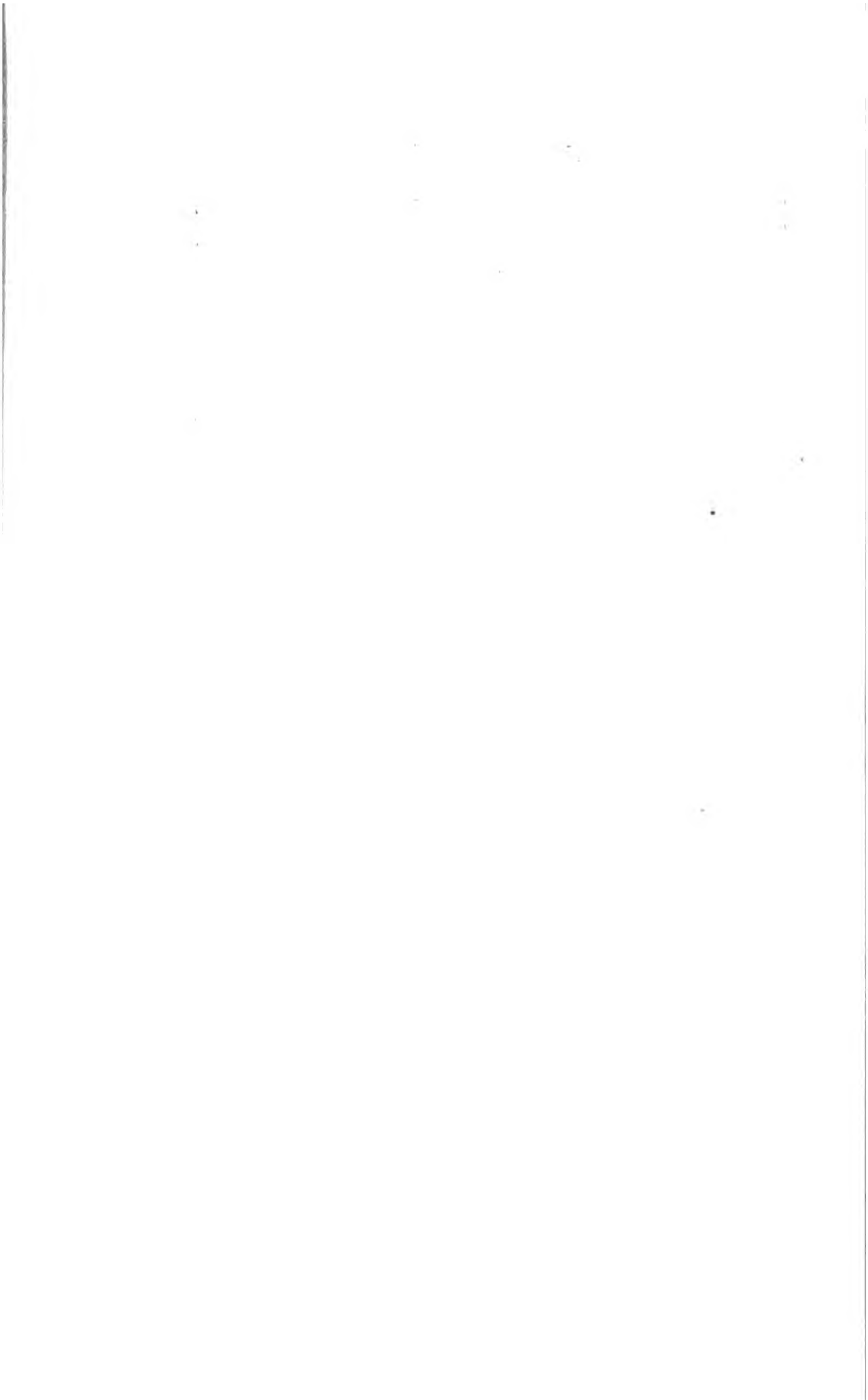
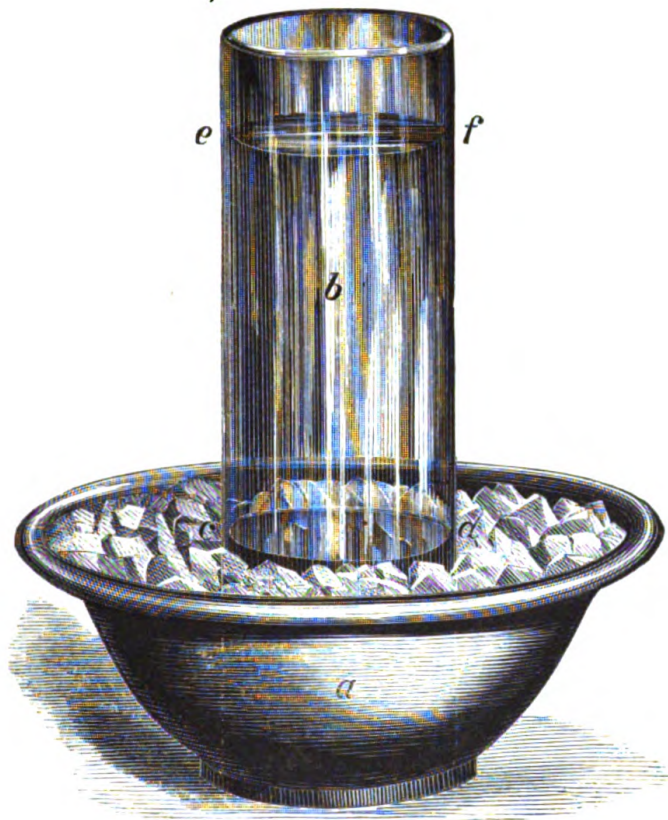

Fig.3.



SCALE OF INCHES





1

2

Fig.3.

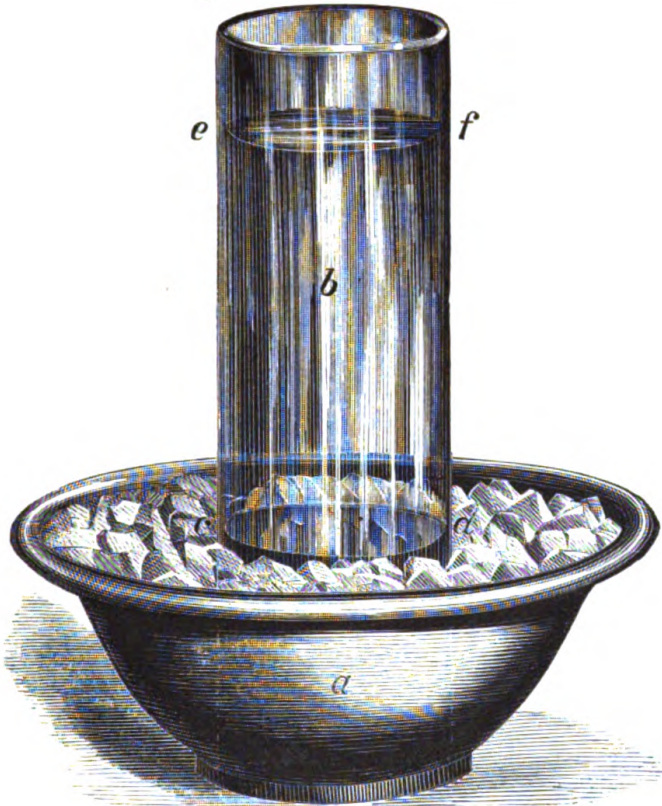

SCALE OF INCHES





bottom of a tall glass jar was thawed by hot water standing on its surface.

a, is an earthen bowl filled with pounded ice and water, in which the glass jar, *b*, was placed.

c, d, is the level of the upper surface of the ice in the jar.

e, f, is the level of the surface of the water standing on the ice in the jar.



PART II.

AN ACCOUNT
OF
SEVERAL NEW EXPERIMENTS,
WITH
OCCASIONAL REMARKS AND OBSERVATIONS,
AND
CONJECTURES
RESPECTING CHEMICAL AFFINITY AND SOLUTION, AND
THE MECHANICAL PRINCIPLE OF ANIMAL LIFE.

CHAPTER I.

Account of a Circumstance of a private Nature, by which the Author has been induced to add this and the following Chapters to the Second Edition of this Essay. — Experimental Investigation of the Subject continued. — OIL found by Experiment to be a Non-Conductor of Heat. — MERCURY is likewise a Non-Conductor. — Probability that all FLUIDS are NON-CONDUCTORS, and that this Property is ESSENTIAL TO FLUIDITY. — The Knowledge of that Fact may be of great Use in enabling us to form more just Ideas with regard to the Nature of those mechanical Operations which take place in chemical Solutions and Combinations, in the Process of Vegetation, and in the various Changes effected by the Powers of Life in the Animal Economy. — Rapidity of Solution no Proof of the Existence of an Attraction of Affinity. — Strata of fresh Water and of salt Water may be made to repose on each other in actual Contact without mixing. — Probability that

the Water at the Bottom of fresh Lakes, that are very deep, may be actually salt.

AT the end of a French translation of the First Edition of this Essay, published at Geneva, Professor Pictet (the translator) has added the following extract of one of my private letters to him (of the 9th of June, 1797), written in answer to one from him to me, acknowledging the receipt of a manuscript copy of the Essay which I had sent him.

“I should have been much surprised if my Seventh Essay had not interested you; for in my life I never felt pleasure equal to that I enjoyed in making the experiments of which I have given an account in that performance. You will perhaps be surprised when I tell you, that I have suppressed a whole Chapter of interesting speculation, merely with a view of leaving to others a tempting field of curious investigation *untouched*, and to give more effect to my concluding reflection, which I consider as being by far the most important of any I have ever published.”

As these assertions (which were not originally intended for the public eye) are liable to several interpretations, I think it my duty, not only to explain them, but also to let the Public know precisely how far I have pushed my inquiries in the investigation of the subject under consideration: This is an act of justice which I owe to those who may be engaged in the same pursuits; for it would be very unfair, by *obscure hints of important information kept back*, to keep others in doubt with respect to the originality of the discoveries they may make in the prosecution of *their* investigations. This would tend to *damp* the spirit of inquiry, instead of *exciting* it; and

throwing out such hints looks so much like lying in wait to seize on the fair fruits of the labours of others, that I cannot rest till I have shewn that I do not deserve to be suspected of such pitiful views.

My worthy friend, Professor Pictet, certainly did not suspect any unhandsome design in any thing I said to him in my (private) letter ; but those who are less acquainted with my character may not be disposed to give me credit for candour and disinterestedness without proofs.

With regard to the assertion in my letter, “ that I had suppressed a whole Chapter of interesting speculation, with a view to leaving to others a tempting field, *untouched*, for curious investigation,” — this is perfectly true in fact, as will, I flatter myself, appear by what I shall now lay before the Public ; and I am confident that those who will take the trouble to consider with attention the reasons which induced me to do this, will find them such as will deserve their approbation.

Having, as I flattered myself, laid open a new and most enticing prospect to those who are fond of philosophical pursuits, I was afraid, if I advanced too far, that others, instead of striking out roads for themselves, might perhaps content themselves with following in my footsteps ; and consequently that many, and probably the most interesting, parts of the new field of inquiry would remain a long time unexplored. And with regard to the reputation of being a *discoverer*, though I rejoice — I might say, exult and triumph — in the progress of human knowledge, and enjoy the sweetest delight in contemplating the advantages to mankind which are derived from the introduction of useful improvements ; yet I can truly say, that I set no very high value on the

honour of being the first to stumble on those treasures which everywhere lie so slightly covered.

In respect to the "concluding reflection" of the First Edition of this Essay, — though some may smile in pity, and others frown at it, I am neither ashamed nor afraid to own, that I consider the subject as being of the *utmost importance* to the peace, order, and happiness of mankind, *in our present advanced state of society*. But to return from these digressions —

Though it appeared to me that the important fact I undertook to investigate, relative to the *manner* in which heat is propagated in Fluids, is fully established by the experiments, of which an account has been given in the preceding Chapters of this Essay; yet, as a thorough examination of the subject is a matter of much importance in many respects, I did not rest my inquiries here, but made a number of experiments with a view to throwing still more light upon it, and enabling us to form more clear and distinct ideas respecting those curious mechanical operations which appear to take place in Fluids, when Heat is propagated in them.

Having frequently observed when a quantity of water in one of my glass jars was frozen to a cake of ice, by placing the jar in a freezing mixture, that, as the ice first began to be formed at the sides of the jar, and increased gradually in thickness, the portion of water in the axis of the jar (which last retained its fluidity), being compressed by the expansion of the ice, was always forced upwards towards the end of the process, and formed a pointed projection of ice in the form of a nipple (*papilla*), which was sometimes above half an inch high in the middle of the upper side of the cake, — I was led by that circumstance to make the following interesting experiments.

Experiment No. 55.

A cake of ice, 3 inches thick, which had a pointed projection, $\frac{1}{2}$ an inch high, which arose from the center of its upper surface, being frozen fast in the bottom of a tall cylindrical glass jar, $4\frac{3}{4}$ inches in diameter, this jar, standing in an earthen pan, and being surrounded by pounded ice and water, to the height of an inch above the level of the upper surface of the cake of ice, was placed on a table, near a window, in a room where the air was at the temperature of 31° of Fahrenheit's thermometer; and fine *olive oil*, which had previously been cooled down to the temperature of 32° , was poured into the jar till it stood at the height of 3 inches above the surface of the cake of ice.

Having ready a solid cylinder of wrought iron, $1\frac{1}{4}$ inch in diameter, and 12 inches long, with a small hook at one end of it, by means of which it could occasionally be suspended in a vertical position, and furnished with a fit hollow cylindrical sheath of thick paper, into which it just passed, — open at both ends, and about $\frac{1}{10}$ of an inch longer than the solid cylinder of iron, to which it served as a covering for keeping it warm, — this iron cylinder, being heated to the temperature of 210° in boiling water, and being suddenly introduced into its sheath, was suspended by an iron wire which descended from the ceiling of the room, in such a manner that its lower end entering the jar (in the direction of its axis) was immersed in the oil to such a depth that the middle of the flat surface of this end of the hot iron, which was directly above the point of the conical projection of ice, was distant from it only $\frac{2}{10}$ of an inch. The end of the sheath descended $\frac{1}{10}$ of an inch lower than the end of the hot metallic cylinder.

As the oil was very transparent, and the jar placed in a favourable light, the conical projection of ice was perfectly visible, even after the hot cylinder was introduced into the jar ; and had *any Heat* DESCENDED through the thin stratum of fluid oil which remained interposed between the hot surface of the iron and the pointed projection of ice which was under it, there is no doubt but this Heat must have been apparent, by the melting of the ice ; which event would have been discovered, either by the diminution of the height of this projection, or by an alteration of its form. But this was not the case : the ice did not appear in the smallest degree diminished, or otherwise affected by the vicinity of the hot iron.

My reader will naturally suppose, without my mentioning the circumstance, that due care was taken, in introducing the cylinder into the jar, to do it in the most gentle manner possible, to prevent the oil from being thrown into undulatory motions ; and that proper means were used for confining the cylinder, motionless, in its place, when it had arrived there.

As this experiment appears to me to be unexceptionable, and its result unequivocal and decisive, in order that a perfect idea may the more easily be formed of it, I have added the Figure 4, where a section of the whole of the apparatus used in making it may be seen, expressed in a clear and distinct manner.

If the general result of the experiments, of which an account has been given in the two first Chapters of this Essay, afforded reason to conclude that *water* is a *non-conductor* of Heat, the result of that here described certainly proves, in a manner quite as satisfactory, that *oil* is also a *non-conductor* ; and serves to give an additional degree of probability to the conjecture, that all Fluids are *necessarily* non-conductors of heat.

As *mercury*, which is a metal in fusion, is different in many respects from all other Fluids, I was very impatient to know if it agreed with them in that essential property, from which they have been denominated non-conductors of Heat, and this I found to be actually the case, by the result of the following decisive experiment.

Experiment No. 56.

Having emptied and cleaned out the cylindrical glass jar used in the last-mentioned experiment, and replenished it with a fresh cake of ice, with a conical projection in the middle of its upper side, I placed the jar, surrounded by pounded ice and water, on the table, in the cold room, where the foregoing experiment had been made; and poured over the cake of ice as much ice-cold *mercury* as covered it to the height of about an inch. Having cleaned the surface of the mercury in the jar with blotting-paper, I suffered the whole to remain quiet about an hour; and then very gently introduced the end of the hot cylinder of iron (inclosed in its paper sheath) into the mercury, and fixed it immoveably in such a position, that its flat end, which was naked, was immediately over the point of the conical projection of ice, and distant from it about $\frac{1}{4}$ of an inch; where I suffered it to remain several minutes.

It is necessary that I should mention, that, in order to prevent the internal motions in the mass of mercury, which would otherwise have been occasioned by the rising and spreading out on its surface of those particles of that fluid, which, having touched the flat end of the hot iron, became specifically lighter in consequence of their increase of temperature, the end of the hollow cylindrical sheath, in which the solid cylinder of iron was placed,

was made to project about $\frac{1}{10}$ of an inch below the flat end of the iron. This precaution was likewise used, and for a similar reason, in the preceding experiment, when oil was used in the place of the mercury; as was mentioned, though without being explained, in giving an account of that experiment.

As the cake of ice, on which the mercury reposed, was at that temperature precisely at which ice is disposed to melt with the smallest additional quantity of Heat, if *any Heat* had found its way *downwards* through the mercury to the ice in this experiment, water would most undoubtedly have been formed, and this water would as undoubtedly have appeared on the surface of the mercury on taking away the iron; but there was not the smallest appearance of any ice having been melted.

To find out whether the cake of ice was *really* at that temperature at which it was disposed to melt with any additional Heat, I thrust down the end of my finger through the mercury, and touched the ice; and this experiment removed all my doubts, for I found that, however expeditiously I performed that operation, it was hardly possible for me to touch the ice without evident signs of water having been produced being left behind, on the clean and bright surface of the mercury, on taking away my finger.

From the results of all these experimental investigations it appears to me that we may safely conclude that *water, oil, and mercury* are perfect *non-conductors* of Heat; or, that when either of those substances takes the form of a Fluid, all interchange and communication of Heat *among its particles*, or from one of them to the other, directly, becomes from that moment *absolutely impossible*.

That this is also the case with respect to the particles

of *air*, has been rendered extremely probable — I believe I might say proved — by the experiments of which I gave an account in one of my papers on Heat published in the Transactions of the Royal Society; and I have shewn elsewhere (in my Sixth Essay) how much reason there is to conclude that the particles of *Steam* and of *Flame* are in the same predicament.

But if all interchange and communication of Heat, from particle to particle, *immediately*, or *de proche en proche*, be absolutely impossible in so many *elastic* and *unelastic Fluids*, and in Fluids so essentially different in many other respects, are there not sufficient grounds to conclude from hence, that this property is common to all Fluids, and that it is even *essential to fluidity*?

It is easy to conceive that the discovery of so important a circumstance must necessarily occasion a considerable change in the ideas we have formed in respect to the mechanical operations which take place in many of the great phenomena of Nature; as well as in many of those still more interesting chemical operations, which we are able to direct, but which we find, alas! very difficult to explain.

In my paper on Heat, above mentioned, published in the Philosophical Transactions for the year 1792, I endeavoured to apply the discovery of the non-conducting power of *air* in accounting for the warmth of the hair of beasts, of the feathers of birds, of artificial clothing, and of snow, the winter garment of the earth; and also, in explaining the causes of the cold winds from the polar regions, and of their different directions in different countries, which prevail at the end of winter, and early in the spring.

In my Sixth Essay (on the Management of Heat and

the Economy of Fuel) I availed myself of the knowledge of the non-conducting power of *steam* and of *flame*, in explaining the effects of a blow-pipe in increasing the action of pure flame, and in investigating the most advantageous forms for boilers; and in the Third Chapter of this Essay I have endeavoured to apply the discoveries which have been made, respecting the manner in which Heat is propagated in *water*, in explaining the means which appear to have been used by the Creator of the world for equalizing the temperatures of the different climates, and preventing the fatal effects of the extremes of heat and of cold on the surface of the globe. But a most interesting application remains to be made of these discoveries, to *chemistry*, *vegetation*, and the *animal economy*; and to the learned in those branches of science I beg leave most earnestly to recommend them. If I am not much mistaken, they will throw a new light on many of those mysterious operations of Nature, in which *inanimate bodies* are put in motion, their forms changed, their component parts separated, and new combinations formed; and it is possible that they may even enable us to account, on mechanical principles, for those surprising appearances of preference and predilection among bodies, which, without ever having been attempted to be explained, have been distinguished by the appellation of *chemical affinity*.

Perhaps it will be found that every change of form, in every kind of substance, is owing to Heat, and to Heat alone; that every concretion is a true *congelation*, effected by cold or a diminution of Heat; and that every change from a solid to a fluid form is a real *fusion*; that the difference between calcination in the *wet* and in the *dry* way is, in fact, much less than has hitherto been

generally imagined; and that no metal is ever dissolved till it has *first been melted*.

Perhaps it will be found, that the apparent violence with which solid bodies of some kinds are attacked by their liquid solvents — and which has, I believe, been considered as a proof of a strong chemical affinity — is not owing to any particular attraction, or election, but to the considerable degree of heat, or of cold, which is produced in their union with their menstrua, — or to a great difference in the specific gravity of the menstruum in its natural state, and that of the same fluid after it has been changed to a saturated solution.

If Fluids are non-conductors of Heat, it is evident that, if any change of temperature takes place in chemical solution, it must necessarily produce *currents* in the solvent, and that these currents must be the more rapid, as the change of temperature is greater; and as they necessarily cause a succession of fresh particles of the solvent to come into contact with the solid, it is evident — all other things being equal — that the rapidity of the process of solution will be as the rapidity of these currents, or as the change of temperature.

But the currents produced by the difference in the specific gravity of the fluid menstruum and of the saturated solution, have perhaps, in general, a still greater effect in bringing a rapid succession of fresh particles of the menstruum into contact with the solid body that is dissolved in it, than those produced by the change of temperature.

When these two causes conspire to accelerate the motion of the same current, or when their tendencies are *in the same direction*, as is the case in the solution of common sea-salt in water, — the solution ought to be most rapid.

When common salt is dissolved in water, the specific gravity of the saturated solution is greater than that of pure water, and will therefore descend in it; and cold being produced in the process, and water being a non-conductor of Heat, the specific gravity of the saturated solution will be *still farther increased*, in consequence of its condensation with this cold, by which its descent in the water will be still farther accelerated.

A curious question here presents itself, which, could it be resolved, might greatly tend to elucidate this abstruse subject of philosophical investigation. Supposing that, in a case where Heat is generated in the solution of a solid in a fluid menstruum, the *addition* to the specific gravity of the menstruum, arising from its chemical union with the solid, should so precisely counterbalance the *diminution* of the specific gravity of the Fluid, by the Heat generated in the process, that the *hot* saturated solution should be precisely of the same specific gravity as the *cold* menstruum, — would or would not the process of solution be possible under such circumstances?

If the *apparent* tendency to approach each other, which we sometimes perceive in solids and their fluid menstrea, were real; if that peculiar kind of attraction of predilection which has been called chemical affinity has a real existence, and if its influence reaches *beyond the point of actual contact* (as has, I believe, been generally supposed), as there is no appearance of any attraction whatever, or affinity, between any solid body and a saturated solution of the same body in its proper menstruum, it seems probable that the solution would take place, under the circumstances described; but should the attraction of affinity, according to the defini-

tion of it here given, have no existence in fact (which is what I very much suspect), in that case it is evident that the solution, though it would not be absolutely impossible, would be so very slow as hardly to be perceptible.

It would not be *impossible*, because the particles of the menstruum in immediate contact with the solid, though in the moment of their saturation they would have no tendency to move out of their places, yet, as they would by degrees necessarily give off to the undissolved part of the solid a part of the Heat acquired in the chemical process by which they were saturated, being condensed by this loss of Heat, they would, at length, begin to descend, and give place to other particles of the menstruum; which, in their turns, would follow them, but with velocities, however, continually decreasing, on account of the gradual augmentation of temperature of the undissolved part of the solid, and of the Heat communicated by that solid substance to the whole mass of the liquid menstruum.

Though it would, probably, be extremely difficult to contrive any single experiment, from the result of which a satisfactory decision of this question could be obtained, yet it does not appear to be impossible to discover by *indirect means* the principal fact on which its decision must depend.

It is a well-known fact, that, when water which holds sea-salt in solution is mixed, in any vessel, with fresh water, the salt will, after a short time, be found to be very equally distributed in every part of the whole mass; and I believe that it has been generally considered that this equal distribution of the salt is owing to the affinity which is supposed to exist between sea-salt and water.

Having doubts with respect to the existence of this

supposed attraction, and suspecting that the equal distribution of the salt was owing to a very different cause, — the internal motions among the particles of the water, occasioned by accidental changes of temperature, — I made the following experiment, which, I fancy, will be considered as decisive.

Experiment No. 57.

I took a cylindrical glass jar, $4\frac{1}{4}$ inches in diameter, and $7\frac{3}{4}$ inches high, and placing it in the middle of another cylindrical glass jar, $7\frac{1}{2}$ inches in diameter and 8 inches high, which stood in a very shallow earthen dish, nearly filled with pounded ice and water, I placed the dish, with its contents, on a strong table, in an uninhabited room in a retired part of the house, where the temperature of the air, which was the same, with very little variation, day and night, was at about 36° F. Having prepared, and at hand, a quantity of the strongest *brine* I could make with sea-salt, which was very clear, transparent, perfectly colourless, and ice-cold, — and also a quantity of fresh or pure water, ice-cold, lightly tinged of a red colour with turnsol, — and some ice-cold *olive oil*, I first poured as much of the fresh water into the small cylindrical jar as was necessary to fill it up to the height of above 2 inches; and then, by means of a glass funnel, which ended in a long and narrow tube, by introducing this tube into the fresh water, and resting it on the bottom of the jar, I poured a quantity of the brine, equal to that of the fresh water, into the jar; and in performing this operation I took so much care to do it gently, and without disturbing the fresh water already in the jar, that, when it was finished, the fresh water, which, as it was coloured red, could easily be distin-

gushed from the brine, remained perfectly separated from this heavier saline liquor, on which it reposed quietly, without the smallest appearance of any tendency to mix with it.

I now filled to the height of about 5 inches the void space between the outside of the small jar and the inside of the large jar in which it was placed with ice-cold water, mixed with a quantity of ice, in pieces as large as walnuts (pounded ice would have obstructed the view in observing, through the sides of the large jar, what passed in the smaller), and when this was done, I very carefully poured ice-cold *olive oil** into the smaller jar till it covered the surface of the (tinged) fresh water to the height of about an inch (see Fig. 5, Plate IV.); and placing myself near the table, in a situation where I had a distinct view of the contents of the small jar, I set myself to observe the result of the experiment.

After waiting above an hour without being able to perceive the smallest appearance of any motion, either in the brine or in the fresh water (the one continuing to repose on the other with the most perfect tranquillity, and without the smallest disposition to mix together), I left the room.

When I returned to it the next day, I found things precisely in the state in which I had left them; and they continued in this state, without the smallest appearance of any change, or of any disposition to change, during *four days*.

At the end of that time, thinking that any farther prolongation of the experiment would be quite useless, I removed the small jar, taking care not to agitate its

* This oil served not only to keep the water on which it reposed quiet, but also to prevent any communication of heat between it and the air of the atmosphere.

contents, and placed it in the window of a room heated by a German stove.

In less than an hour I perceived that the brine and the (tinged) fresh water began to mix, and at the end of 24 hours they were intimately mixed throughout, as was evident by the colour of the aqueous fluid on which the oil reposed; which now appeared to the eye to form one uniform mass of a light red tint.

I shall leave it to philosophers to draw their own conclusions from the results of this experiment. In the mean time there is one fact which it seems to point out that I shall just mention, which is not only curious in itself, but may lead to very important discoveries. It appears to me to afford strong reasons to conclude that, were a lake but *very deep*, its waters, near the surface, would necessarily be fresh, even though its bottom should be one solid mass of rock salt!

Would it be ridiculous to make experiments to determine whether the water at the bottom of some very deep lakes is not impregnated with salt? Should it be found to be actually the case, it might prove an inexhaustible treasure in an inland country, where salt is scarce.

As mines of rock-salt are often found in the neighbourhood of fresh lakes, it seems reasonable to suppose that the waters of such lakes should *sometimes* be in contact with *strata* of these mines; and when I first began to meditate on the subject, I was much surprised, not that the salt water which may lie at the bottom of fresh lakes should not already have been discovered, — for from the first I plainly perceived that nothing could happen in the ordinary course of things that could bring it to the light, or even afford any grounds to suspect its

existence, — but, as *strata* of salt mines frequently lie higher than the mean level of the country, I was surprised that lakes of *salt water* should not more frequently be found ; and as these reflections occurred to me *after* I had discovered what appeared to me to be an evident proof of the wisdom and goodness of the Creator in *making* all lakes in cold countries *fresh*, I began to be alarmed for the fatal consequences that might ensue, if, by chance, the side of a lake should come into contact with a mountain of salt, as I saw might easily happen.

Shall I, or shall I not, attempt to give my reader an idea of what I felt, when, meditating on the subject, and almost beginning to repent of what many, no doubt, have already condemned as the foolish dream of an enthusiastic imagination, I saw, all at once, that the most effectual care had been taken to prevent the evils I apprehended, — that from the very constitution of things, and the ordinary and uniform operation of the known laws of Nature, the permanent *existence of a lake, SALT AT THE SURFACE, is absolutely impossible*, even though it should be surrounded on every side by mountains of salt ? *

Though the explosion of a volcano, an earthquake, or any other great convulsion, by which the shores of a lake might be brought into contact with a vast mine of salt, might cause the whole mass of its water to be salt for a time, yet the evil would soon effect its own remedy : the falling in of the crust of earth and stones by which mines of salt are everywhere found to be covered (and without which they could not exist) would very soon cover the naked salt, and the water *at the surface of the*

* By the word *Lake* I mean, as is easy to perceive, a collection of water, in a high inland situation, from which there is a constant efflux.

lake would again become perfectly fresh. Should, however, the lake be so deep that the temperature at the bottom should remain the same summer and winter, without any sensible variation, it is most certain that its waters *there* (at the bottom of the lake) would remain perfectly saturated with salt forever.

But are there not some reasons to conclude that the water at the bottoms of *all very deep lakes* ought necessarily to be salt, even in situations where there are no mines of salt near?

The sea-shells that are frequently found in high inland situations, as well as many other appearances noticed by naturalists, strongly indicate that most of our continents have been covered by the waters of the ocean. Now if that event ever happened, — however remote the period may be at which it took place, — it seems highly probable that the salt water left at the bottoms of all deep lakes, by the sea, on its retiring, *must be there now*.

I cannot take my leave of this subject without just observing, that the discovery of the *impossibility* of the permanent existence of what we can plainly perceive would be an evil certainly ought not to *diminish* our admiration of the wisdom of the great Architect of the Universe.

CHAPTER II.

Water made to congeal at its under Surface. — Observation respecting the Formation of Ice at the Bottoms of Rivers. — Reasons for concluding that Heat can never be equally distributed in any Fluid. — Perpetual Motions occasioned in Fluids by the unequal Distribution of Heat. — An inconceivably rapid Succession of Collisions among the integrant Particles of Fluids is occasioned by the internal Motions into which Fluids are thrown in the Propagation of Heat. — An Attempt to estimate the Number of those Collisions which take place in a given Time. — These Investigations will greatly change our Ideas respecting the real State of Fluids apparently at rest. — FLUIDITY may be called the LIFE OF INANIMATE BODIES. — Conjectures respecting the VITAL PRINCIPLE in living animals; and the Nature of Physical STIMULATION.

WHATEVER the mechanical operation may in fact be, by which those effects are produced that have given rise to the idea of the existence of an attraction of affinity (a power different from gravitation) between solid bodies and their liquid menstrea, and between different portions of the same menstruum differently saturated, the result of the foregoing experiment (No. 57) proves that two particles of water in combination with very different quantities of sea-salt, — or a particle of water *saturated* with salt, and another perfectly free from salt, *may be* in contact with each other for any length of time without showing any appearance of a disposition to equalize the salt between them.

But should we even admit as a fact, what this experi-

ment seems to indicate, namely, that there is no such thing as an *attraction of predilection* between solids and their solvents, and that all those motions which have been attributed to the action of that supposed power (as well as all other motions which take place in Fluids) are the immediate effects of *gravitation* acting according to immutable laws, and *changes of specific gravity by Heat*; yet there would still remain one great difficulty in explaining chemical solution. As all mechanical operations require a *certain time* for their performance; and as the motion which is occasioned in a Fluid by a change of specific gravity in any individual particles of it *begins* as soon as the change begins to take place, if there be no attraction between the particles of solid bodies and the particles of their menstrea; as Heat is supposed to be generated or absorbed, or — to speak more properly — both generated and absorbed, in the *contact* of those particles, and previous to the completion of their chemical union, — how does it happen that the particle of the menstruum whose specific gravity is necessarily changed by this change of temperature does not *immediately* quit the solid, in consequence of this change, and before the process of solution has *had time to be completed*?

A consideration of the effects of the *vis inertiae* of the particle of the menstruum whose specific gravity is thus changed, and also of the *vis inertiae* of the rest of the Fluid, and the resistance it must oppose to the motion of its individual solitary particles, would furnish us with arguments that might be employed with advantage in removing this difficulty; but I fancy that the result of the experiment of which I shall presently give an account will be more satisfactory than any reasoning, unsupported by facts, that I could offer on the subject.

When a doubt arises with regard to the *possibility* of any operation of a peculiar kind, which is *supposed* to take place, in any process of nature among those infinitely small integrant particles of bodies which escape, and must ever escape, the cognizance of our gross organs, however they may be assisted by art, the shortest way of deciding the question is to put the known powers of nature in action under such circumstances that the effects produced by them must show, unequivocally, whether the supposed operation be possible or not; and if it be found to be possible in one case, we may then argue with less diffidence on the probability of its actually taking place in the specific case in question.

It has been abundantly proved by the experiments of M. de Luc, and by those of my friend Sir Charles Blagden, that when water, in cooling, has arrived at the temperature of about 41° F., its condensation with cold ceases, and it begins to expand, and continues to expand gradually as its temperature goes on to be farther diminished, till it is changed to ice. Availing myself of that most important discovery, I made the following experiment.

Experiment No. 58.

Having poured *mercury*, at the temperature of 60° , into a common glass tumbler, till this Fluid stood at the height of about an inch, I then poured about twice as much water (at the same temperature) upon it; and, placing the tumbler in a shallow earthen dish, surrounded it to the height of the level of the surface of the mercury with a freezing mixture of snow and common salt. Having done this, I was very curious indeed to see in what part of the water ice would first make its appear-

ance. Could it be at the upper surface of it? That appeared to me to be impossible; for, the experiment being made in a room warmed by a German stove, the temperature of the air which reposed on that surface was considerably above the point at which water freezes.

Could it be at its lower surface, where it rested on the upper surface of the mercury? If that should happen, it would show that, notwithstanding the diminution of the specific gravity of the water in passing from the temperature of 41° to that of 32° , and the tendency which this diminution gave it to quit the service of the mercury from the instant when, in being cooled by a contact with it, it had passed the point of 41° , yet there was time sufficient for the congelation to be completed *before the particle of water so cooled could make its escape.*

The reader will naturally conclude from what was said in the preceding page, that it was merely with a view to the determination of that single fact that this experiment was contrived; and he will perceive by the result of it that my expectations with regard to it were fully answered.

Ice was not only formed *at the bottom of the water*, at its under surface, where it was in contact with the cold mercury, but I found on repeating the experiment, and varying it, by previously cooling the mercury in the tumbler to about 10° , that *boiling hot water*, poured gently upon it, was instantly frozen, and gradually formed a thick cake of ice, covering the mercury; though almost the whole of the mass of the unfrozen water which rested on this ice remained nearly boiling hot.

This experiment not only determines the point for the decision of which it was undertaken, but also enables

us to form a just opinion respecting a matter of fact which has been the subject of a good deal of dispute.

Though many accounts have been published of ice found at the bottom of rivers, yet doubts have been entertained of the possibility of its being *formed* in that situation. From the result of the foregoing experiment it appears to me that we may safely conclude, that, if after a very long and a very severe frost, by which the surface of the ground has not only been frozen to a considerable depth, but also cooled several degrees below the freezing-point, a river should overflow its banks, and cover the surface of ground *previously so cooled*, ice would be formed at the bottom of the water; but all the experiments that have been made on the congelation of water show the absolute impossibility of ice being ever formed, in any country, at the bottom of a river which constantly fills its banks, or which never leaves its bed exposed, dry, to the cold air of the atmosphere.

By reflecting on the various consequences that ought to follow from the peculiar manner in which Heat appears to be propagated in Fluids, we are led to conclude, that it is almost impossible that any Fluid exposed to the action of light should ever be throughout of the same temperature, though its mass be ever so small; and that the difference in the Heat of its different particles must occasion perpetual motions among them.

Suppose any open vessel, — as a common glass tumbler, for instance, — containing a piece of money, a small pebble, or any other small solid opaque body, to be filled with water, and exposed in a window, or elsewhere, to the action of the sun's rays. As a ray of light cannot fail to generate Heat when and where it is stopped or absorbed, the rays, which, entering the water, and

passing through it, impinge against the small solid opaque body at the bottom of the vessel, and are *there absorbed*, must necessarily generate a certain quantity of Heat; a part of which will penetrate into the interior parts of the solid, and a part of it will be communicated to those colder particles of the water which repose on its surface.

Let us suppose the quantity of Heat so communicated to one of the integrant particles of the water to be so small, that its effect in diminishing the specific gravity of the particle is but just sufficient to cause it to move upwards in the mass of the liquid with the very smallest degree of velocity that would be perceptible by our organs of sight, were the particle in motion large enough to be visible. This would be at the rate of about *one hundredth part of an inch* in a second.

This velocity, though it appears to us to be slow in the extreme, when we compare it with those motions that we perceive among the various bodies by which we are surrounded, yet we shall be surprised when we find what a rapid succession of events it is capable of producing.

If we suppose the diameter of the integrant particles, or *molecules* of water, to be *one millionth part of an inch* (and it is highly probable that they are even less*), in that case, it is most certain that an individual particle, moving on in a quiescent mass of that Fluid with the velocity in question, namely, at the rate of $\frac{1}{10000}$ part of an inch in 1 second, would run through a space equal to *ten thousand times the length of its diameter* in one second,

* Leaf gold, such as is prepared and sold by the gold-beaters, is not *four times* as thick as the diameter here assumed for the integrant particles of water. These leaves of solid metal have been found by computation to be no more than $\frac{1}{282020}$ of an inch in thickness. How much less must be the diameter of the integrant particles of gold?

and, consequently, would come into contact with at least *six hundred thousand* different particles of water in that time.

Hence it appears how inconceivably short the time must be that an individual particle, in motion, of any Fluid, can remain in contact with any other individual particle, not in motion, against which it strikes in its progress, however slow that progress may appear to us to be through the quiescent mass of the Fluid!

Supposing the contact to last as long as the moving particle employs in passing through a space equal to the length of its diameter, — which is evidently all that is possible, and more than is probable; then, in the case just stated, the contact could not possibly last longer than $\frac{1}{10000}$ part of a second! This is the time which a cannon bullet, flying with its greatest velocity (that of 1600 feet in a second) would employ in advancing 2 inches.

If the cannon bullet be a *nine pounder*, its diameter will be four inches; and if it move with a velocity of 1600 feet (= 19200 inches) in a second, it will pass through a space just equal to 4800 times the length of its diameter in 1 second. But we have seen that a particle of water moving $\frac{1}{100}$ of an inch in a second actually passes through a space equal to 10000 times the length of its diameter in that time. Hence it appears that *the velocity with which the moving body quits the spaces it occupies* is more than twice as great in the particle of water as in the cannon bullet!

There is one more computation which may be of use in enabling us to form more just ideas of the subject under consideration; and surely too much cannot be done to enlighten the mind, and assist the imagination,

in our attempts to contemplate those invisible operations of nature which nothing but the sharpest ken of the intellectual eye will ever be able to detect and seize.

As succeeding events which fall under the cognizance of our senses cannot be distinguished if they happen oftener than about *ten times in a second*,* it appears that when a particle of water moves in a quiescent mass of that fluid at the rate of $\frac{1}{100}$ part of an inch only, in one second, its succeeding collisions with the different particles, at rest, of that fluid, against which it strikes as it moves on, must be so inconceivably rapid that no less than *one thousand* of them must actually take place, *one after the other*, in the shortest space of time that is perceptible by the human mind. †

* This assertion, in as far, at least, as it relates to objects of sight, may be proved by the following easy experiment: Let a wheel, with any known number of spokes, be turned round its axis with such a velocity as shall be found necessary, in order that the spokes may disappear or become invisible. From the velocity of the wheel, and the number of spokes in it, the fact will be decided.

† It probably will not escape the observation of my learned readers, that the velocity which I have here assigned to the single particle of water, moving upwards in that fluid in consequence of a change of its specific gravity by Heat, though apparently very small ($\frac{1}{100}$ part of an inch in a second), is however, most probably, considerably greater, in fact, than any individual *solitary* particle of that fluid could possibly acquire, in the supposed circumstances, by any change of temperature, however great, owing to the resistance which would necessarily be opposed to its motion by the quiescent particles of the fluid. Aware of this objection, and being desirous of being prepared to meet it, I took some pains to compute, by the rules laid down by Sir Isaac Newton in his *Principia*, Book II. Sect. vii., what the greatest velocity is that a solitary particle of water (supposed to be $\frac{1}{100000}$ of an inch in diameter) could possibly acquire by a given change of its specific gravity. And I found that if the specific gravity of water at the temperature of 32° F. be taken at 1.00082, and its specific gravity at 80° at 0.99759, as lately determined by accurate experiments, then a single particle of water at the temperature of 80° , situated in a quiescent mass of that fluid at 32° , the greatest velocity this hot particle could acquire in moving upwards in consequence of its comparative levity would be that of $\frac{1}{2638}$ part of an inch in 1 second. This is at the rate of about one inch and an half in 1 hour. But it is evident, that when great numbers of particles unite and form currents, they will make their way through the quiescent fluid with greater facility, and consequently will move faster.

After we have patiently examined the result of these investigations, and the imagination has become *familiarized* with the contemplation of the interesting facts they present to it, how much will our ideas be changed with regard to the real state of fluids apparently at rest! They will then appear to us to be, what no doubt they really are in fact, an assemblage of an infinite number of infinitely small particles of matter moving continually, or without ceasing, and with inconceivable velocities.

We shall then consider fluidity as the *life of inanimate bodies*, and congelation as the *sleep of death*; and we shall cease to ascribe active powers, or exertions of any kind, to dead *motionless* matter.

But what shall we think of the *vital principle* in living animals? Does not their life also depend on the internal motions in *their* fluids, occasioned by an *unequal* distribution of heat? And is not *stimulation*, in all cases, the mere mechanical effect of the communication of Heat?

It is an opinion which we know to be as old as the days of Moses, that *the life of an animal resides in its blood*; and it is highly probable that it dates from a period still more remote. It was lately revived by an anatomist and physiologist (now no more), who was eminently distinguished for sagacity; and it appears to me that the late discoveries respecting the manner in which Heat is propagated in Fluids tend greatly to elucidate the subject, and to give to the hypothesis a high degree of probability.

According to this hypothesis (as it may now be explained), everything that increases the *inequality of the distribution* of the Heat in the mass of the blood (even though it should not immediately augment its quantity) ought to increase the intensity of those *actions* in which

life consists. But are there not many striking proofs that this is the case in fact?

Do not *respiration, digestion, and insensible perspiration*, all tend evidently (that is to say, according to our assumed principles with regard to the manner in which Heat is propagated in Fluids) to *produce* and to *perpetuate* this inequality of Heat in the animal fluids? And do we not see what an immediate and powerful effect they have in increasing the intensity of the action of the powers of life?

If animal life depends essentially on those *internal* motions in the animal fluids, which, as has been shown, are occasioned by the difference of the *specific gravities* of their integrant particles, or *molecules*, arising from their different temperatures, — in that case it is evident that the *vital powers* would be strengthened, or their action increased, either by *heat* or by *cold* properly applied. But is not this found to be the case in fact? Does not the *dram of brandy* at St. Petersburg produce the same effects as the *draught of iced lemonade* at Naples, and by the same mechanical operation, but acting in opposite directions? And does not the *loss of Heat*, by insensible perspiration, contribute as efficaciously to the preservation of that *inequality of temperature* which is essential to life, as the *introduction of Heat* into the system in respiration?

Is not the sudden coagulation of blood, when drawn from a living animal, and are not all the other rapid changes that take place in it, evident proofs of an unequal distribution of Heat? And does not the *viscosity* of blood, as well as its perpetual motions in the vascular system, contribute very powerfully to the preservation of that inequality?

Are not the livid spots on the surface of the body, which indicate a beginning of mortification, produced in consequence of a separation or *precipitation* of the heterogeneous particles of the animal Fluids, according to their specific gravities and individual temperatures, occasioned by rest or an interruption of circulation? And may we not emphatically pronounce such Fluids to be dead?

Would not any liquid in which Heat were *equally distributed* be a *fatal poison* if injected into the veins of a living animal? And would not this be the case even were the liquid so injected a portion of the animal's own blood, or of the lymph or any other of its component parts, and were it at the mean temperature precisely of the healthy Fluids circulating in the veins and arteries of the animal?

Is not glandular secretion a true precipitation? and is it not possible that the formation of the solids and the growth of an animal body may be effected by a process exactly similar to congelation? And are there not even circumstances from which we might conclude, with a considerable degree of probability, that most of these congelations are formed at or about the temperature of boiling water?

But I forbear to enlarge on this subject. I find I have unawares entered a province, where, if I advance farther, I shall certainly be exposed to the danger of being considered and treated as an intruder; and I must hasten to make my retreat, which I shall endeavour to effect by abruptly putting an end to this Chapter.

CHAPTER III.

Probability that intense Heat frequently exists in the solitary Particles of Fluids, which neither the Feeling nor the Thermometer can detect. — The Evaporation of Ice during the severest Frost explained on that Supposition. — Probability that the Metals would evaporate when exposed to the Action of the Sun's Rays were they not good Conductors of Heat. — Mercury is actually found to evaporate under the mean Temperature of the Atmosphere. — This Fact is a striking Proof that FLUID MERCURY is a Non-conductor of Heat. — Probability that the Heat generated by the Rays of Light is always the same in intensity; and that those Effects which have been attributed to Light ought perhaps in all Cases to be ascribed to the Action of the Heat generated by them. — A striking Proof that the most intense Heat does sometimes exist where we should not expect to find it. — Gold actually melted by the Heat which exists in the Air of the Atmosphere, where there is no Appearance of Fire, or of anything red-hot. — We ought to be cautious in attributing to the Action of unknown Powers, Effects similar to those produced by the Agency of Heat. — The most intense Heat may exist without leaving any visible Traces of its Existence behind it. — This important Fact illustrated by the necessary Result of an imaginary Experiment.

HOW far the possibility of the communication of Heat between the integrant particles of a Fluid may or may not be owing to the extreme mobility of those particles, and to the infinitely short time that two of them, of different specific gravities (owing to a dif-

ference of temperature), can remain in contact, I leave others to determine; in the mean time, it is most certain that the existence of this impossibility of any immediate communication of Heat among the particles of a Fluid renders the distribution of Heat very unequal; and it seems highly probable that many appearances which have been attributed to very different causes are in fact owing to *intense Heat* existing and producing the effects proper to it in situations where its existence has not even been suspected.

If Fluids are non-conductors* of Heat, no situation can possibly be more favourable to its preservation than when it exists in them; and it is not only evident, *a priori*, that the most intense Heat *may exist* in a few solitary particles of some Fluids without its being possible for us to detect it, or to discover the fact, either by our feeling or by the thermometer; but there are many appearances that strongly indicate, and others that prove, that intense Heat actually does exist in that concealed or imperceptible state very often.

There is no reason to suppose that it is possible for ice to be reduced to steam without being previously melted; and it is well known that ice cannot be melted with a lower degree of Heat than that of 32° of Fahrenheit's scale: but in the midst of winter, in the coldest climates, and when the temperature of air of the atmosphere, as shown by the thermometer, has been much below 32° , ice, exposed to the air, has been found to evaporate.

How can we account for this event, except it be by supposing that some of the particles of air which accidentally (as we express it) come into contact with the ice are so hot, as not only to melt the small particles of ice which they happen to touch, but also to reduce a part of

the generated water to steam, before it has time to freeze again; or by supposing that this is effected by intense Heat generated by light absorbed by small projecting points of the ice? As ice is a very bad conductor of Heat, that circumstance renders it more likely that the event in question should actually take place in either of these ways.

If the metals were very bad conductors of Heat, instead of being very good conductors of it, I think it more than probable that even they would be found to evaporate when exposed to the action of the direct rays of the sun; and perhaps also in situations in which such an event would appear still more extraordinary.

MERCURY has been actually found to *evaporate* under the mean temperature of the atmosphere! What a striking proof is this that *fluid mercury* is a non-conductor of Heat, and also, that very intense Heat may be generated, or exist where it would not naturally be expected to be found! And does not the evaporation of water under the mean temperature of the atmosphere afford another proof of this last fact?

That the most intense heat is often excited in very small particles of solid bodies dispersed about in the midst of masses of cold liquids is not to be doubted. It is well known what an intense Heat the rays of the sun are capable of exciting; and it seems to be highly probable that Heat actually excited by them is always the same, that is to say, *intense in the extreme*: but when the rays are few, and when circumstances are not favourable to the *accumulation* of the Heat they generate, it is often so soon dispersed that it escapes the cognizance of our senses and of our instruments, and sometimes leaves no visible traces of its existence behind it.

Why should we not suppose that the Heat generated by a ray of light, which, entering a mass of cold water, accidentally meets with an infinitely small particle of any solid and opaque substance which happens to be floating in the liquid, and is absorbed by it, is not just as intense as that generated in the focus of the most powerful burning mirror or lens?

Mr. Senebier has given us an account of a great number of interesting experiments on the effects produced on different bodies by exposure to the direct rays of the sun; but why may we not attribute all those effects to the intense *local* Heat, generated by the light absorbed by the infinitely small, and, if I may use the expression, *insulated* particles of the bodies which were found to be affected by it?

The surface of wood of various kinds was turned brown. The same appearances might be produced in a shorter time by the rays which proceed from a red-hot iron, which change the surface of the wood to an imperfect coal. But were not the surfaces of the woods which were turned brown by the light of the sun in Mr. Senebier's experiments changed to an imperfect coal? And is it possible for a Heat less intense than that of *incandescence* to produce that effect?

Among the many facts that might be adduced to prove that the most intense Heat *may*, and frequently *does exist* where we should not expect to find it, the following appears to me to be very striking and convincing. It is, I believe, generally imagined that the intensity of the heat generated in the combustion of fuel is much less in a small fire than in a great one; but there is reason to think that this is an erroneous opinion, founded on appearances that are not conclusive; at least, it is certain

that the intense Heat of a large smelting furnace, such as is necessary for melting the most refractory metals, actually exists in the feeble flame of the smallest candle; and what may appear still more extraordinary, this intense degree of Heat often exists in the air of the atmosphere, *where no visible signs of Heat appear*, as I shall presently show.

Iron is fully *red-hot* by daylight at the temperature of about 1000° of Fahrenheit's scale; brass melts at 3807° , copper at 4587° , silver at 4717° , and gold at 5237° ; and nothing is more certain than that the Heat must be at that intensity which corresponds to the 5237th degree of Fahrenheit's scale, *where gold is found to melt*. But very fine gold, silver, or copper wire, flatted, (such as is used to cover thread to make lace,) melts instantaneously on being held in the flame of a candle. It will even be melted if it be held a few seconds *over* the flame of a candle, *at the distance of more than an inch from the top of the flame*, in a place where there is no appearance of fire, or of anything red-hot.

From the important information which we acquire from the result of these experiments, we see how much we ought to be on our guard in forming an opinion with respect to the *intensity* of the Heat which *may exist* in the invisible insulated particles of matter of any kind that may be scattered about in a given space, or which may float in any Fluid, where neither our feeling nor our thermometers can possibly be sensibly affected by it.

A thermometer can do no more than indicate the *mean of the different temperatures of all those bodies or particles of matter which happen to come into contact with it*. If it be suspended in air, it will indicate the mean of the temperatures of those particles of air *which happen to*

touch it ; but it can never give us any information respecting the *relative* temperatures of those particles of air.

If, during the most intense frost, a thermometer were suspended in the neighbourhood of a burning candle, — in the same room, for instance, — if it were placed over the candle, or nearly so, though it should be distant from it several feet, as air is a non-conductor of Heat, there is not the smallest doubt but that some solitary particles of air, heated by the candle to the intense Heat of melting gold, would reach the thermometer ; but neither the thermometer, nor the hand held in the same place, could give any indication of such an event.

As it appears, from all that has been said, that intense heat *may exist* even under the form of *sensible Heat*, where its presence cannot be discovered or detected by us ; and as it seems highly probable that in many cases, where its existence may escape our observation, it may nevertheless be capable of producing very visible effects, I think we ought always to be much on our guard in accounting for effects similar to those which are known to be produced by Heat, and never, without very sufficient reasons, attribute them to the agency of any other *unknown* power ; and this caution appears to me to be peculiarly necessary in accounting for those effects which have been found to be produced in various bodies when they are exposed to the action of the sun's rays.

If the solar rays concentrated in the focus of a lens, when they are made to fall on a piece of wood, instantly change its surface to a black colour, and reduce it to charcoal, why may we not conclude that the change of colour which is gradually or more slowly produced in the same kind of wood when it is simply exposed in the sunbeams is produced in the same manner ?

The difference in the *times* necessary to produce similar effects in these two cases is no proof that they are not produced *in the same manner*; for if they are effected merely by the agency of Heat (which I suppose), then the effects produced in any given time will not be as the density of the light or as the number of rays, but as that part of the Heat generated which, not being immediately dispersed or carried off by the air, has time to produce the action proper to it in the wood; and consequently must be incomparably greater, in proportion, when the rays are concentrated, than when they are not.

Luna cornea exposed to the action of light changes colour; but why should we not attribute this change to the expulsion of the oxygen united with the metal, by the agency of the Heat generated by the light? To remove every possible objection to this explanation of the phenomenon nothing more appears to be necessary than to admit what is well known, — that this metallic oxyd may be reduced, without addition, *with some degree of Heat*, and that this substance is a bad conductor of Heat.

Will not the admission of our hypothesis respecting the *intensity* of the Heat which is supposed to be generated where light is stopped, and of that respecting the non-conducting power of Fluids with regard to Heat, enable us to account, in a manner more satisfactory than has hitherto been done, for the effects of the sun's light in bleaching linen, when it is exposed wet to the action of his direct rays? as also for the reduction of those metallic oxyds which have been found to be revived by exposure to light? And will it not also assist us in accounting for the production of pure air in the beautiful experiment of Dr. Ingen-Housz, in which the green leaves

of living vegetables are exposed, immersed in water, to the sun's rays ?

Mr. Senebier has shown that the colouring matter of healthy green leaves of vegetables, which is extracted from them by spirits of wine, and which tinges the spirits of a beautiful green colour, is destroyed, or rather changed to a dirty brown colour, in a few minutes, on exposing this tincture in a transparent phial, and *in contact with pure air*, to the direct rays of a bright sun ; but why should we not consider this process as a real combustion ?

The Heat acquired by the liquid, — which, as I have often perceived in repeating the experiment, is very considerable, — and the necessity there is for the presence of *pure air*, that the experiment may succeed, seem to indicate that something very like combustion must take place in it.

If liquids are non-conductors of Heat, they ought, certainly, *on that account*, to be peculiarly well calculated for confining and consequently furthering the operations of that Heat which is generated by light, or by any other means, in their integrant particles, or in the infinitely small and insulated particles of other bodies that are dispersed about, or held in solution in them ; as I have already more than once had occasion to observe.

If this supposition be admitted, a very great difficulty will be removed in accounting for chemical solution on the hypothesis that the change of form from a solid to a fluid state is in all cases a real fusion ; or that it is effected by the sole agency of Heat ; and that concretion, or crystallization, is a process in all respects perfectly analogous to freezing.

There are but three forms under which sensible bodies

are found to exist, — namely, that of a *solid*, that of a *fluid*, and that of an *elastic fluid*, or *gas*; and it is well known that every substance with which we are acquainted — all ponderable matter without exception — is capable of existing alternately under all those forms indifferently; and that the form under which it appears *at any given time* depends on its *temperature at that time*.

We know farther that every identical substance undergoes these different changes of form at certain fixed temperatures; and when we consider the subject with attention we shall find that, had not these temperatures been fixed, and had they not been different in different bodies, it would have been utterly impossible for us to have identified any substance whatever.

Perhaps this is the only essential difference that really exists among bodies that appear to us to be different.

But not only the degrees of Heat, or points in the scale of temperature at which the forms of different bodies are changed, are various, but the *extent of the variation of temperature* under which a substance can persevere, or continue to maintain its form in its *middle state*, — that of *fluidity*, or rather *liquidity*, — is very different in different bodies; and this last circumstance has a wonderful effect in increasing the variety of the compositions and decompositions which are continually taking place in the various operations of nature on the surface of the globe.

Another circumstance, not less prolific in events, is the union which takes place between bodies of *different kinds*; and those most important changes in regard to the degrees of Heat which the bodies so united can support without having their forms changed, which are found to result from such union.

When, to the established laws which have been discovered in the operations of nature in the change of form in substances that appear to us to be *simple*, we add those which have been found to obtain in the changes of form of bodies that are known to be *compounded*, we shall perhaps be able to conceive some more distinct ideas with regard to the nature of those mechanical operations which take place in chemical processes. I call them *mechanical*, — for mechanical they must of necessity be, according to the most rigid interpretation of that expression.

But the hypothesis of the existence of *intense Heat* in the midst of cold liquids is so new, and seems to be so contrary to the result of all our experience and observation, that I feel it to be necessary to take some pains to illustrate the matter.

And first, we must not expect always to find traces remaining of the existence of intense Heat, even where there are the strongest reasons to think it has actually existed; for as often as Heat is dispersed or carried off, before it has had time to produce any changes of form, or chemical changes or combinations in the bodies to which it is communicated, it leaves no marks behind it.

Fire-arms are often found to miss fire, even when many live sparks from the flint and steel actually fall into the pan among the priming; but nobody, surely, will pretend that the small particles of *red-hot iron* which fall among the grains of the gunpowder, and cool in contact with them, are not intensely hot, — incomparably more so than would be necessary to inflame the powder were their Heat of sufficient *duration* to produce that effect. Had these small sparks been invisible, it is highly probable that their existence would never have been suspected,

and that the fact which they prove would not have been believed.

That gunpowder may be inflamed, it is necessary that the sulphur which constitutes one of its component parts should be first *melted* and then *boiled*; for it is the vapour of boiling sulphur which always takes fire when gunpowder is kindled.

Were melted sulphur a conductor of Heat, there is reason to think that gunpowder would be very far from being so inflammable as we find it to be.

As those who have not been much accustomed to meditate on the subject under consideration may find some difficulty in conceiving how it is possible for intense Heat to be *excited* in or to *exist* in the midst of a mass of any cold liquid, — as of water, for instance, — without immediately producing visible effects, I feel it to be my duty to put that matter in the clearest light possible, and to show that what I have considered as being *probable* is most undoubtedly very far from being impossible.

The best method of proceeding in inquiries of this kind, where the principal object is to discover whether a supposed event, which, from its nature, cannot fall under the cognizance of our senses, is or is not possible, seems to me to be, to begin by supposing the event to have actually taken place, and then to trace its necessary consequences, and compare them with those appearances which are actually found to take place.

Adopting this method, we will suppose a quantity of pure water, at the mean temperature of the atmosphere in England, that of 55° F., to be put into a clean and very transparent glass tumbler, placed in a window and exposed to the direct rays of the sun. If the glass and the water are both *perfectly transparent*, it is evident that

no Heat will be generated in either of them by the sun's light.

If now a small particle of any opaque solid body be suspended in the midst of the water in the tumbler, those rays of light, which, impinging against it, are absorbed by it, must necessarily generate Heat in the very moment when they are stopped. This is an incontrovertible fact, which nobody will dispute.

In order to render this imaginary experiment more interesting, we will suppose the solid body put into the water to be a small particle of yellow amber; and that its specific gravity is so exactly equal to that of the water that it has no tendency to move in it, either upwards or downwards, and consequently will remain in the situation where it is placed, without being suspended; and we will suppose, farther, that this solid particle of amber is nearly globular, and $\frac{1}{1500}$ of an inch in diameter, which is just equal to the diameter of a single thread of silk, as spun by the worm, and is probably one of the smallest objects that is perceptible by the human eye, unassisted by art.

As it is evident that Heat must be generated or excited in this small particle of amber by the light it stops or absorbs, the points which remain to be discussed are, therefore, what *its intensity* is at the moment of its existence; and what are the effects which it ought to produce in consequence of that intensity.

The reasons have already been mentioned which render it probable that when Heat is generated by the rays of light, its intensity, *where it is generated*, and before it has been diminished in consequence of its dispersion, is always the same; and, taking it for granted that this is the case in fact, we will endeavour to trace the operations

of that Heat — extreme in its intensity, or degree, but small in regard to its quantity, or to the space it occupies — which is generated in the particle of amber in the experiment under consideration.

As this Heat must first exist where it is generated, it is evident that it must exist at the surface of the particle of amber; and as all solid bodies are, in a greater or less degree, conductors of Heat, a part of this Heat will penetrate the substance of the solid particle, while another part of it will be carried off by the cold particles of water in contact with the surface thus heated by the light.

It remains, therefore, to be determined what the effects are which this Heat — so absorbed, on the one hand, by the solid particle of amber, and communicated to the water, on the other — ought necessarily to produce. And first, if the dispersion of the Heat by both these means should be sufficiently rapid to prevent its accumulation to such a degree as to melt the amber, it is evident that no visible effects by which its existence could be discovered would be produced in that substance; and this event (the fusion of the amber) will depend on three circumstances, namely, — First, on the temperature at which amber melts; Secondly, on the facility with which Heat expands and is dispersed in a solid mass of that substance, or on its conducting power; and Thirdly, on the rapidity with which the Heat generated at the surface of the amber is carried off by the cold Fluid in which it is immersed.

Though I do not think there would be any reason for surprise, even admitting the existence of the supposed intense Heat, should the amber be found not to be melted under the circumstances described, yet it appears to me

to be extremely probable, that if amber, in a very fine powder, were mixed with any transparent oil, capable of supporting a great degree of Heat without being reduced to vapour, and exposed in it to the direct rays of a very bright sun, the amber would melt and be dissolved, though perhaps very slowly.

But if amber does not melt when exposed in water to the action of the sun's beams, and consequently suffers no visible change by which the existence of the Heat supposed to be generated at its surface by the light can be detected, ought not this Heat, were it, in fact, as intense as it is supposed to be, to produce some visible effects in the water, by which its existence would necessarily be discovered?

To resolve this doubt, we must inquire what visible effects it would be possible for the Heat in question to produce in the water. Now if we suppose the water not to be decomposed by this Heat, which, as no chemical change is supposed to take place in the amber, cannot happen, the only effect this Heat can possibly produce on the water is an increase of its temperature, which increase must, however, be much too small to be detected, either by the feeling or by the thermometer.

It might, perhaps, be expected that *steam* would be found at the heated surface of the particle of amber, and become visible; but when we consider the matter for a moment, we shall see that it is quite impossible that such an event should happen, for even on the supposition (which, however, is far from being probable) that the same individual particles of water which come into contact with the hot surface of the amber should remain in contact with it till their temperatures should gradually be raised to that point at which water is changed to

steam, yet, from the extreme rapidity with which steam condenses when in contact with cold water, it is evident that it could not exist an instant under the circumstances here supposed. Indeed, we have direct proofs that steam cannot exist under such circumstances, by what is found to happen when large masses of iron or steel, raised to a most intense heat, in a blast furnace, are suddenly plunged into cold water by smiths, in tempering edge-tools; for these masses of red-hot metal may be distinctly seen to be in actual contact with the cold water, and did not a part of the water which is decomposed by the hot iron make its escape in the form of inflammable air, it is not probable that there would be any visible appearance from which the formation of steam could be suspected.

Hence we see the possibility of the existence of *intense Heat* in the midst of a mass of cold water, or of any other transparent liquid, without producing any visible effects, or leaving behind it any traces by which its existence could be suspected.

Let us now consider a case in which this intense Heat, though perfectly imperceptible on account of the extreme minuteness of the particles of matter in which it exists, is capable, nevertheless, of producing very visible effects. Let us suppose a solution of nitro-muriate of gold in water to be exposed to the action of the sun's rays. If this solution were *perfectly* transparent, no Heat could possibly be generated in it by light; but as it is not so, Heat, in the highest degree of intensity, must necessarily be generated by those opaque particles (of the oxyd of gold) by which it is stopped. Now as gold is a very heavy substance, it is evident that it must be reduced to extremely small particles in order that, when changed to

an oxyd by its union with oxygen, it may be dissolved in and continue suspended in water; and it is clear that the smaller any insulated particle of matter is, at the surface of which Heat is generated in consequence of the absorption of light, the more suddenly must the Heat so generated be dispersed through the whole substance of the particle, and the more equally and more intensely must that particle be heated; from hence it appears evidently, that, if the particles of the oxyd dispersed about in the water are but *small enough*, the Heat generated in them by the sun's rays will be sufficient to expel the oxygen united to the gold, and revive that metal.

There is one very obvious objection that will doubtless be made to this conclusion, which, however, may easily be removed. The particle of the metallic oxyd which is supposed to be heated is in contact with the water; how does it happen that a great part of this Heat does not immediately pass off into that cold Fluid? I might answer, because both water and steam are non-conductors of Heat, and might adduce in support of this reason the well-known fact that a drop of water dropped on a piece of iron, heated to most intense white Heat, will remain some time on the iron without being evaporated, even considerably longer than if the iron were much less hot; but a circumstance attending the beautiful experiment in which iron is burned in oxygen gas affords a more direct proof of the fact in question.

As this experiment is commonly made, the iron, which is a piece of small wire, a few inches long, is introduced into a bottle, with a narrow neck, which contains the oxygen gas; the wire being fixed in its place, by causing its upper end to pass through a cork stopple, which is fitted to the mouth of the bottle. The lower end of

the wire is pointed ; and it is set on fire by being first heated in the flame of a candle, and then plunged suddenly, while red-hot, into the bottle. The combustion begins the moment the end of the wire enters the oxygen gas ; and the metal continues to burn with the utmost violence, and with a copious emission of intense white light, till the wire, or till all the gas is consumed, affording one of the most brilliant and most interesting sights that can be imagined.

The product of this combustion is the oxygenation of the iron ; and this metallic oxyd, in a state of fusion, and heated to the most intense white Heat, falls to the bottom of the bottle in globules of different sizes.

To protect the glass against these drops of calx of iron in fusion, it is usual to leave a quantity of cold water in the bottle, — enough, for instance, to cover its bottom to the height of about an inch ; but I have frequently seen numbers of these globules, much smaller than peas, which have not only descended *red-hot* through the water, but have remained red-hot at the bottom of the bottle, surrounded by the water, at least two or three seconds, and actually melted the glass on which they reposed (and as far as I can recollect) without producing the smallest appearance of steam.

The water could not be decomposed, for the iron was already saturated with oxygen.

This experiment will, I fancy, be considered as affording an indisputable proof that *intense Heat* may exist, at least for a short time, in a small particle of matter surrounded by a cold Fluid.

Now, as it has been found by actual experiment, that when a solution of nitro-muriate of gold in water is exposed to the action of the sun's rays, the gold is revived ;

and as it is known that an oxyd of gold may be reduced in the dry way without addition, or merely by intense Heat, why should we not conclude that it is merely by *Heat* that that metal is revived in the case under consideration, and that the *intensity* of the Heat by which this oxygenation is effected is precisely the same in both cases ?

Should this supposition be admitted, we might, perhaps, venture to proceed one step farther, and consider the nature and progress of the mechanical operations which take place in disoxygenation of metals, or their precipitation from a solution of their oxyds, when that operation is effected by means of Heat generated, not by light, but by the contact or union of infinitely small particles of bodies, different in kind, and disposed to generate or to absorb sensible Heat on coming together ; which particles being dispersed about in the liquid solution, and in the substance added to it to effect the precipitation, are by this mixture brought into contact.

This would naturally lead us to an examination of the phenomena of solution ; and those clearly understood would, no doubt, give us a distinct view of the mechanical operations by which those tendencies to union are effected which have been designated under the name *elective attraction*.

But how arduous an undertaking ! what intense study ! what efforts of the imagination would be necessary to trace out and form distinct ideas of such a succession of events, all perfectly imperceptible by our organs, though assisted by all the resources of art !

Sensible of my own weakness, I dare not proceed any farther. Perhaps it will be thought that I have already

advanced much too far; but it is right that I should acknowledge fairly, that in the present case the temerity I have shown has not been entirely without design.

There are two ways in which philosophers, as well as other men, may be excited to action, and induced to engage zealously in the investigation of any curious subject of inquiry, — they may be *enticed*, and they may be *provoked*.

It will probably not escape the penetration of my reader, that I have endeavoured to use both these methods. I am well aware of the danger that attends the latter of them; but the passionate fondness that I feel for the favourite objects of my pursuits frequently hurries me on far beyond the bounds which prudence would mark to circumscribe my adventurous excursions.

CHAPTER IV.

An Account of a Variety of Miscellaneous Experiments. — Thermometers with cylindrical Bulbs may be used to show that Liquids are Non-conductors of Heat. — Ice-cold Water may be heated and made to boil standing on Ice. — Remarkable Appearances attending the thawing of Ice, and the melting of Tallow and of Bees-Wax, by means of the radiant Heat projected downwards by a red-hot Bullet. — Beautiful Crystals of Sea-Salt formed in Brine standing on Mercury. — Olive-Oil soon rendered colourless by Exposure to the Air standing on Brine. — An Attempt to cause radiant Heat from a red-hot Iron Bullet to descend in Oil. — Account of an artificial Atmosphere in which

horizontal Currents were produced by Heat. — Conjectures respecting the proximate Causes of the Winds.

THOUGH this Essay is already grown to a much larger size than I originally intended, and even larger than I could have wished (well knowing how great an evil a great book is generally thought to be), I could not bring it to a conclusion without adding one Chapter more. In this Chapter the reader will find accounts of several experiments, some of which he will probably consider as not altogether uninteresting. To take up as little of his time as possible, I shall be very brief in these accounts, and in general shall leave the reader to draw his own conclusions from the results of the experiments I shall describe.

§ 1. *An Account of several simple Experiments, which show that Heat does not descend in Fluids.*

If a thermometer constructed with a long and narrow, naked cylindrical bulb (6 inches long, for instance, and $\frac{1}{2}$ an inch in diameter), and filled with mercury, oil, spirits of wine, or any other Fluid proper for that purpose, with which it is required to make the experiment in question, — such thermometer being at the temperature of the air in summer, or at any temperature above the point of freezing water, — if the lower end, or half, of its bulb be plunged into a glass tumbler filled quite full to the brim with pounded ice and water, the height of the Fluid in the tube of the instrument will show that half the Fluid in the cylindrical bulb of the instrument is ice-cold, while the temperature of the other half of it remains unchanged.

The result will be the same, when, to prevent the communication of Heat from the air during the experiment, that part of the bulb of the thermometer (the superior half of it) which projects above the level of the top of the tumbler is covered with a sheath lined with soft fur.

When more or less than half of the bulb of the thermometer is plunged into the ice and water, the height of the liquid in the tube of the instrument will show that that part only of the Fluid in the bulb is cooled which occupies the part of the bulb that is immersed in the ice and water.

§ 2. *Ice-cold Water, standing on Ice, may be heated and made to boil without melting the Ice, contrary to an Opinion that has generally prevailed.*

Take a thin glass tube 1 inch in diameter, and about 8 or 10 inches long, containing about two or three inches of water, and by plunging the end of the tube into a freezing mixture of pounded ice and sea-salt cause the water in the tube to congeal; this being done, pour two or three inches of ice-cold water on the ice; and wrapping up about two inches of the lower end of the tube with a piece of flannel, and holding it inclined at an angle of about 45° , by that part of it which is so covered, bring that part of the tube which is at the height of the surface of the fluid-water to be just over the point of the flame of a burning candle, and distant from it about two or three inches. When the water in that part of the tube begins to boil, the tube may be advanced slowly over the flame of the candle; and if due care be taken to prevent a too sudden application of

the Heat, all the water in the tube to within one quarter of an inch of the ice may be brought into the most violent ebullition before the ice will begin to be melted, and at last will appear to boil even at the very surface of the ice.

§ 3. *The radiant Heat from a red-hot Iron Bullet does not appear to be able to make its Way downwards through liquid Water, nor through melted Tallow, nor melted Wax.*

1st Experiment. — A very small mercurial thermometer, with a naked globular bulb, was laid down in an horizontal position on two small projections of wax, in the bottom of a shallow wooden dish, in such a manner that, the engraved scale of the thermometer lying uppermost, the height of the mercury in its tube could be observed. This being done, I poured cold water into the dish till it stood at the height of about $\frac{1}{4}$ of an inch above the bulb of the thermometer, and then presented to the thermometer an iron bullet about $1\frac{1}{2}$ inches in diameter, red-hot, which I held (by means of a fit handle) directly over its bulb at the distance of about an inch.

The thermometer seemed to take very little notice of the vicinity of the red-hot iron.

When its bulb was covered with oil the result of the experiment was much the same, but when it was exposed naked, or uncovered by a liquid, to the rays from the hot iron, it appeared to acquire Heat very rapidly. But the two following experiments were still more decisive and satisfactory.

2d Experiment. — A shallow earthen dish, about 3 inches deep and 12 inches in diameter at its brim, was filled with water, and, being exposed in a cold room in

winter, the water was frozen, and formed a cake of ice at its surface about an inch thick. Letting the dish remain in its place, in order that the surface of the ice might remain perfectly horizontal (which was necessary to the complete success of the experiment, as will presently be seen), I entered the room with a chafing-dish filled with live coals, in the midst of which was my iron bullet, perfectly red-hot; and taking out the bullet from among those burning coals, I held it over the center of this horizontal sheet of ice, and distant from it about $\frac{1}{10}$ of an inch.

The ice directly under the red-hot bullet was soon thawed, but the depth to which it was thawed was very inconsiderable; the water, however, extended itself slowly from the center towards the circumference, and at length a circular spot 2 or 3 inches in diameter in the center of the surface of the ice was covered with it, though but to a very inconsiderable depth.

This little spreading sea appeared to prey on the wall of ice by which it was surrounded on every side.

The particles of water in contact with this wall being rendered specifically lighter on becoming ice-cold, they move upwards, and, making way for other warmer particles to advance from below, cause currents in opposite directions to set between the center (where the hot iron remains) and the circumference. As a current at the temperature of 41° must necessarily set downwards at the middle of the circle, this current, striking against the middle of the excavation formed in the ice, ought to deepen it gradually in that part, though but slowly, — and this is what was actually found to be the case; for the bottom of this excavation was not perfectly flat, but was deeper at and near its center than at its sides.

3d Experiment. — When this experiment was varied by using a flat cake of tallow instead of a cake of ice, a very extraordinary appearance indeed presented itself, which at first surprised me very much, but which I soon perceived was a new and very striking proof that Fluids are non-conductors of Heat.

The bottom of the circular cavity in the cake of tallow which was occupied by that part of the tallow that had been melted in the experiment, instead of being concave, as I had found that in the ice to be, or flat, as I expected to find this, was *convex* in the middle, or rather rose up in the form of a protuberance, or very blunt point, the extremity of which reached almost to the surface of the melted tallow! As the iron bullet was held as near as possible to the tallow, the end of this projection, which remained unmelted, was certainly not more than $\frac{2}{10}$ of an inch distant from this red-hot ball! Reflecting on the unexpected result of this experiment I was much struck, and not a little humiliated, with the proof it seemed to me to afford of the impossibility of predicting with certainty any event, however inevitable it may appear, which has not actually been seen to happen.

Though I well knew how the Heat must be communicated under the given circumstances, and could foretel with certainty the directions of the currents it must necessarily occasion in the melting tallow; yet the utmost efforts of my intellectual powers, exercised as they were by much meditation, were not sufficient to enable me to foresee that the point where least Heat would be communicated was that precisely which was nearest to the red-hot bullet, and that a protuberance of unmelted tallow would be left in that place.

Let those be very cautious who speculate on the supposed results of experiments they have never made!

On repeating this experiment, and varying it by using a cake of fine bleached *bees-wax*, instead of tallow, the result was much the same; the protuberance, however, in the middle of the circular cavity occupied by the melted wax, though perfectly perceptible, was less considerable in height than that in the cake of tallow.

§ 4. *Beautiful Crystals of Sea-Salt formed in Brine standing on Mercury.*

A small quantity of strong brine, standing on mercury in an open glass tumbler, having by accident been left in a room in a retired part of the house, I observed at the end of about six months that two beautiful crystals of salt, perfectly quadrangular, had been formed in it, one of which was $\frac{1}{4}\frac{4}{0}$ of an inch long, $\frac{1}{4}\frac{1}{0}$ of an inch wide, and $\frac{5}{4}\frac{0}{0}$ of an inch in thickness; and the other $\frac{1}{4}\frac{2}{0}$ of an inch long, $\frac{1}{4}\frac{0}{0}$ of an inch wide, and $\frac{1}{8}\frac{1}{0}$ of an inch thick.

Did the Fluid mercury on which this brine reposed contribute — and how — to the regularity of the form and the uncommon size of these crystals? And might not beautiful crystals of other salts be procured by similar means?

§ 5. *Olive-Oil rendered colourless by Exposure to the Air standing on Brine.*

A quantity of *olive-oil*, about $\frac{3}{4}$ of an inch in depth, having by accident been left standing in an open glass jar, about four inches in diameter, on about a quart of brine, moderately strong, in a retired room where the sun's rays never enter, — at the end of about six months I

observed that the oil had become perfectly colourless, and appeared to me to be nearly as transparent as the purest water. On the approach of winter I found that this oil was much more liable to be congealed with cold than oil of the same kind which had stood near it many months in a large glass bottle closed with a cork.

§ 6. *An unsuccessful Attempt to cause radiant Heat from a red-hot Iron Bullet to descend in Oil.*

Having poured a quantity of this colourless oil into a glass tumbler, and caused it to congeal throughout, I presented to its upper surface a red-hot iron bullet, $1\frac{1}{2}$ inches in diameter, and held it quite close to the oil several minutes, till the bullet ceased to be red-hot. As the oil seemed rather to be merely thickened by the cold, and to have lost its transparency in consequence of the presence of a number of opaque particles, which were everywhere dispersed about in it, than to be congealed into a solid mass, I thought that if it were possible for radiant Heat to descend in any Fluid it might perhaps be in this; and if this should happen I was certain to make the discovery by the manner in which the oil recovered its transparency; for should radiant heat descend, the form of the mass of oil first restored to its transparency must necessarily have been *hemispherical*, or some section of a sphere, or at least of some convex figure; but the under part of that part of the oil which was restored to its transparency in this experiment was, to all appearance, as perfectly flat and horizontal as the upper surface of it, which proves that the Heat, by which the congealed oil was thawed, was communicated to it, not immediately by the red-hot bullet, but *me-*

diately by means of the Heat absorbed by or generated in the sides of the tumbler. This experiment appears to me to be important in many respects ; but it would be foreign to my present purpose to engage in an investigation of the subject with which it is most intimately connected.

I cannot finish this Essay without giving my reader an account of one more experiment, the result of which was not only quite unexpected, but uncommonly interesting.

Happening accidentally to place in a window the little instrument I had contrived for rendering visible the internal motions which are occasioned in water when Heat is propagated in that fluid,* as it was winter, and the room was warmed by a German stove, that side of the instrument which happened to be nearest the window being exposed to a current of cold air, while the instrument received Heat continually on the other side from the warmer air of the room, the liquid in the instrument was thrown into motions which never ceased, and afforded a very interesting sight.

With a view merely to amuse myself, and the friends who should happen to call in to visit me, and without the smallest expectation of making any new discoveries, I contrived, and caused to be executed, the instrument I am now about to describe, which I thought could not fail to render these motions perpetual, and exhibit them in a striking manner.

A flat box was formed of two equal panes, each 13 inches high, and $10\frac{1}{2}$ inches wide, of fine ground glass, fitted into a square frame of brass in such a manner that these two panes (which are parallel to each other) are at

* For a description of this instrument see Chapter II. of this Essay.

the distance of 1 inch from each other. In the middle of the top of this brass frame there is a circular opening about $\frac{1}{2}$ an inch in diameter, into which a projecting cylindrical brass tube, about half an inch in length, is soldered; and in the middle of the bottom of the frame there is a similar tube which projects downward. The first of these openings serves for introducing into the flat box the liquid with which it is filled, and the other for drawing it off; and they are both well closed with fit stopples of cork.

On both sides of this brass frame there are deep grooves into which the panes of glass are fitted, and the box was made water-tight by luting the joinings of the glass with the frame with glazier's putty. On the outside of the frame there are thin projections of sheet brass, by means of which the box was fixed in one of the sashes of a window in my room, where it occupied the place of a pane of glass, which was removed to make way for it. This window fronts the southeast, and consequently is exposed to the sun a great part of the day.

Having provided a sufficient quantity of the saline solution (of the same kind as was used in constructing the instrument above mentioned, contrived for rendering visible the internal motions in Fluids), and having mixed with it a due proportion of pulverized yellow amber, I now filled the box half full with this mixture, and as the air in the room was considerably warmer than that without, I expected that the motions in the liquid occasioned by the passage of the Heat would immediately commence.

This actually happened; but how great was my surprise when, instead of the vertical currents I expected, I discovered horizontal currents running in opposite di-

rections, one above another, — or regular WINDS, which, springing up in the different regions of this artificial atmosphere, prevailed for a long time with the utmost regularity, while the small particles of the amber collecting themselves together formed clouds of the most fantastic forms, which, being carried by the winds, rendered the scene perfectly fascinating!

It would be impossible to describe the avidity with which I gazed on these enchanting appearances.

In the state of enthusiasm in which I then was, it really seemed to me that Nature had for a moment drawn back the veil with which she hides from mortal eyes her most secret and most interesting operations, and that I now saw the machinery at work by which winds and storms are raised in the atmosphere!

Nothing seemed to be wanting to complete this bewitching scene, and give it the air of perfect enchantment, but that lightning, in miniature, should burst from these little clouds; and they were frequently so thickened up, and had so much the appearance of preparing for a storm, that had that event actually taken place, it could hardly have increased my wonder and ecstasy.

There were several accidental circumstances attending this experiment which contributed to render it more interesting. The sun, which happened to be remarkably bright, shone full upon the window where the apparatus was placed; and as the grooves in the frame in which the plates of glass were fixed were not deep, that part of this frame which formed the narrow bottom of the box being exposed to the sun's rays, a considerable quantity of Heat was generated by them in that place, as appeared by the motions of the particles of pulverized amber which lay on the bottom of the box, or those which were brought there by the currents.

When these particles, on being heated by the sunbeams, began to move, they first arose up nearly perpendicularly ; but before they had risen to any considerable height, they were carried away obliquely and nearly in an horizontal direction by the lower current, answering to the wind which in the atmosphere prevails at the surface of the earth.

The perpendicular rise of these particles from the bottom of the box, and the subsequent change of their direction, called to my remembrance an appearance very common in hot countries, which I recollected to have often seen, and by which I had often been amused in my youth : in very hot and dry weather, when the wind is still and the sun very powerful, the air which lies on the ground often appears in the most violent agitation, resembling that of a boiling liquid ; which motion is most rapid at the surface of the earth, and appears to cease at the height of five or six feet above the ground.

Is not this violent agitation occasioned by the conflict which takes place between the hot and the comparatively cold air moving *vertically*, and in opposite directions, very near the surface of the ground ? And are not the winds which prevail above occasioned by the efforts of whole *strata* of air to ascend or descend obliquely ?

The currents I observed to prevail in my artificial atmosphere were never perfectly horizontal ; and if my suspicions with respect to the cause of the winds are well founded, neither can those winds be horizontal which prevail in the superior regions of the atmosphere of the earth, though they may be very nearly so.

The greatest velocity of the currents in the saline liquid in this experiment was nearly two inches in a minute, but their motions were in general much slower.

As the windows in the room in which this experiment was made are double (as are all those both in summer and winter in the apartment I inhabit), and as the apparatus above described occupied the place of a pane of glass belonging to the inside window, it was in my power, by opening either the inside window or the outside window, to cause the Heat on the two opposite sides of the box to be either equal or unequal at pleasure; and by variations which that arrangement enabled me to make in the experiments, I produced several interesting appearances.

There was one very striking appearance indeed which never failed to present itself regularly every day during the three weeks that the experiment was continued.* The clouds, after having been driven about all day by the different currents in the liquid (of which there were sometimes as many as six or seven running in opposite directions at the same time), never failed to collect themselves together in the evening into large masses; sometimes forming only one, and sometimes two or three *strata* at different heights, where they remained to all appearance perfectly motionless during the night.

There can be no question with respect to the *proximate* cause of this phenomenon, for it was undoubtedly owing to a diminution or total cessation of the operation of that cause — of those causes, or of some of them — by which an inequality of temperature in the liquid was produced and continued; but it would be highly curious to investigate the more remote causes of this appearance, and see how far *light*, or rather the absence of it, was concerned in producing it: but that discussion would lead me into a very abstruse inquiry, — that re-

* An end was put to the experiment by an accident; the box being broken by the carelessness of a servant in shutting the window-shutter.

specting radiant Heat, — which would take up more time than I am at present able to bestow on it. Perhaps I may find leisure and courage at some future period to attempt that most difficult investigation. My reader will doubtless have observed that I have hitherto taken pains to avoid it.

I cannot take my leave of the experiment I have been describing without giving my reader a faithful account of everything I can recollect respecting it, and particularly of one accidental circumstance, which it is possible may have had some share in producing the interesting appearances which so powerfully attracted my attention.

The saline liquor and the pulverized amber were mixed in a bottle, and were not put into the flat box till after it had been fixed in the sash or frame of the window, but when I came to pour this mixture into the box I found that I had not provided enough of it. To supply this defect, without the trouble of emptying the box, I added, at several different times, pure water, and a strong solution of potash, in such proportions as I knew to be proper to produce the specific gravity required, and then endeavoured to mix the whole as intimately as possible by agitating the liquor for some considerable time by means of a long and strong quill, the end of which I thrust down into the box through the hole by which the liquor was introduced.

Whether those different portions of liquor were in fact intimately mingled by these means I cannot positively determine. They certainly had every appearance of being so; for the amber was evidently well mixed, and very equally distributed in every part of the Fluid. But even should we grant that the liquid remained divided in different *strata*, arranged according to the specific gravities

of the different portions of it that were poured into the box at different times, it does not appear to me that the result of the experiment would be less interesting on that account, or the application of it less satisfactory in explaining the cause of the winds in the atmosphere.

I am, however, far from being desirous that much stress should be laid on this single experiment, being perfectly sensible that others may be contrived, the results of which would be more decisive ; in the mean time it appears to me that the hint given us is too plain not to deserve some attention. If it should awaken the curiosity of experimental philosophers, and excite them to farther investigation, the end I had principally in view in publishing this account of it will be completely answered.

DESCRIPTION OF THE PLATES.

PLATE III.

FIG. 4. This figure represents a vertical section of the apparatus used in the experiment No. 55 (see page 341), in which an attempt was made to melt the top of a projecting point of ice by Heat transmitted *downwards* through olive-oil communicated by a solid cylinder of iron, heated in boiling water.

In this figure the tall glass jar (in the bottom of which the cake of ice was frozen) is standing in an earthen pan filled with pounded ice.

The *oil* is also represented standing on the *cake of ice* in the jar; and the iron cylinder in its sheath of paper suspended in the axis of the jar in such a manner that the lower end of this cylinder, which is flat, is directly over the pointed projection of ice, and distant from it $\frac{2}{10}$ of an inch.

PLATE IV.

Fig. 5. This figure shows the manner in which the experiment No. 57 (see page 350) was made when pure or fresh water in a glass jar was made to repose on brine, or water saturated with sea-salt, without mixing with it.

In this experiment the smaller jar, which contained the brine, the pure water, and a quantity of olive-oil by which the surface of the pure water was covered, stood in a larger glass jar, which last stood in a shallow earthen dish filled with pounded ice and water.

The space between the outside of the smaller jar and the inside of the larger jar was filled to the height of about an inch above the level of the surface of the oil in the smaller jar with pieces of ice nearly as large as walnuts, and ice-cold water.

Fig. 4.

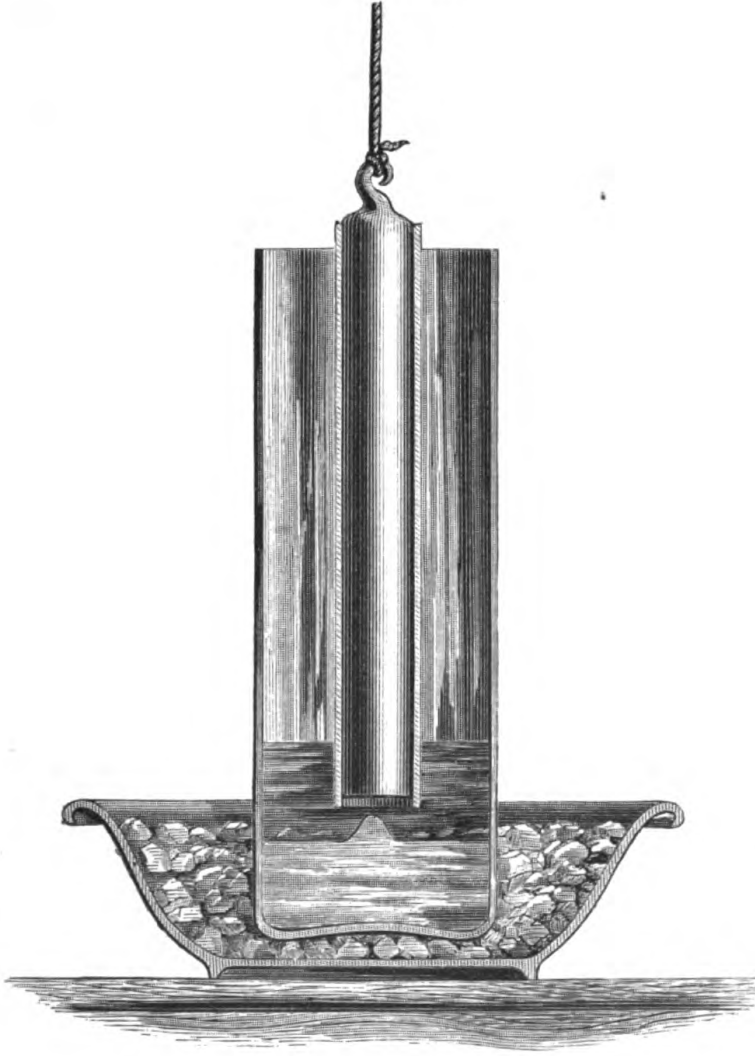

SCALE OF INCHES



Fig. 5.



FORBES & CO. BOSTON

SCALE OF INCHES



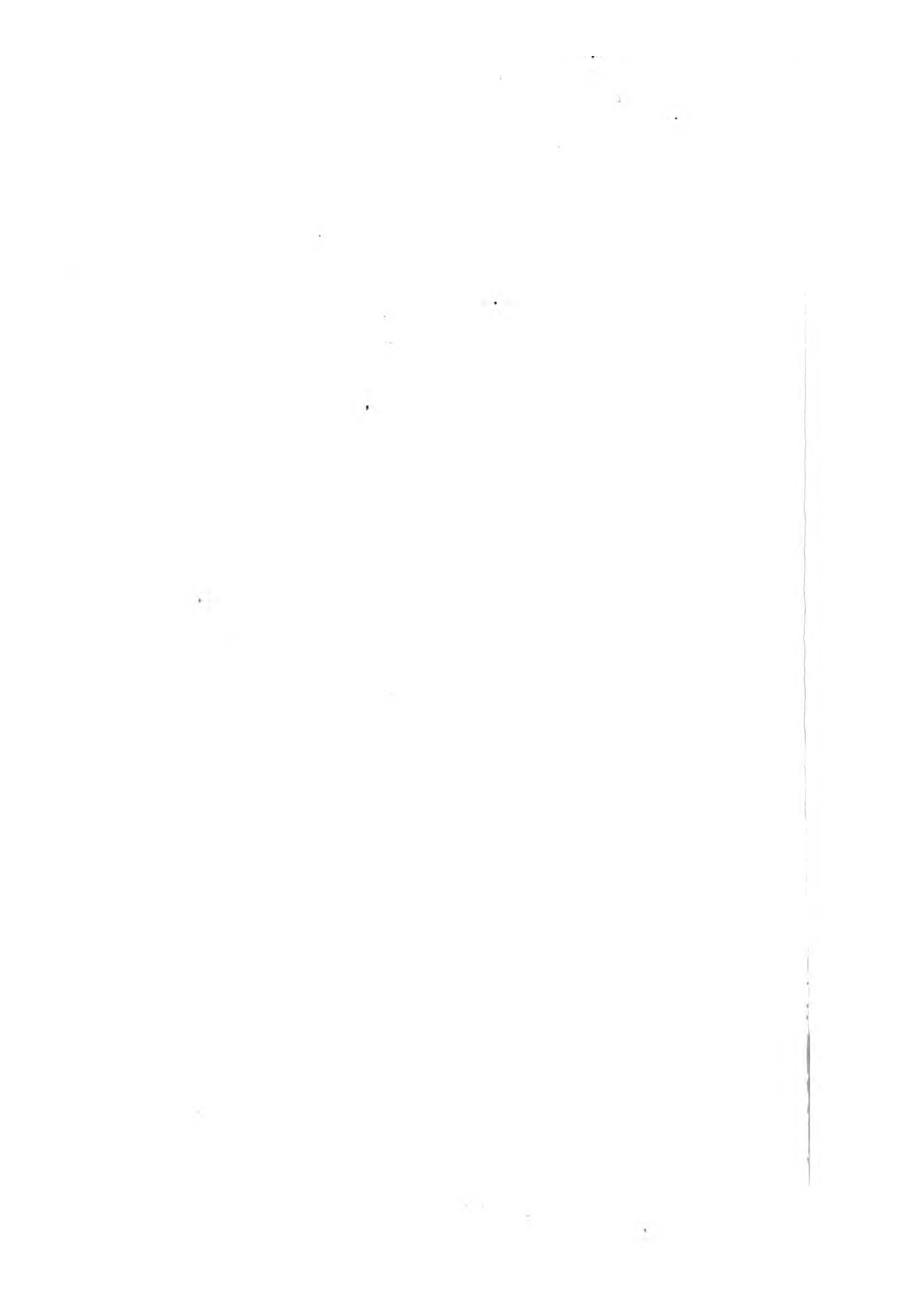

Fig. 5.



SCALE OF INCHES

FORBES & CO. BOSTON

OF THE
PROPAGATION OF HEAT
IN
VARIOUS SUBSTANCES:

BEING

*An Account of a Number of NEW EXPERIMENTS made
with a View to the Investigation of the CAUSES of the
WARMTH of NATURAL and ARTIFICIAL CLOTHING.*

INTRODUCTION.

THIS Essay contains nothing that will be new to philosophical readers; for it is little more than the substance of two Papers which have already appeared in the Philosophical Transactions of the Royal Society of London; one in the year 1786, and the other (for which the Author had the honour to receive from the Society the Copleian Annual Medal) in the year 1792.

As reference has frequently been made to these Papers in several of the preceding Essays; and as many of the experiments of which an account is given in them are not only interesting in themselves, but are necessary to be known in all their details in order to judge of several important conclusions that have been founded on their results, the Author has thought that it would not be improper to republish them under the present form. He was also desirous of adding the substance of those Papers to his Sixth and Seventh Essays, in order that all that he has written on the *Science of Heat* might be brought together in one volume.

The Essays which are destined to compose the next volume (many of which are already in great forwardness) are all on practical subjects of a popular nature, and of general utility; and on that account it was judged best to keep them separate from those contained

in this volume, which partake more of the nature of abstruse philosophical investigations.

Various unforeseen events have contributed to retard the publication of the promised Essays on Kitchen Fire-places—on Cottage Fire-places—and on Clothing; but the Author has well-founded hopes of being able to bring them forward in the course of a few months.

Fig. 1.

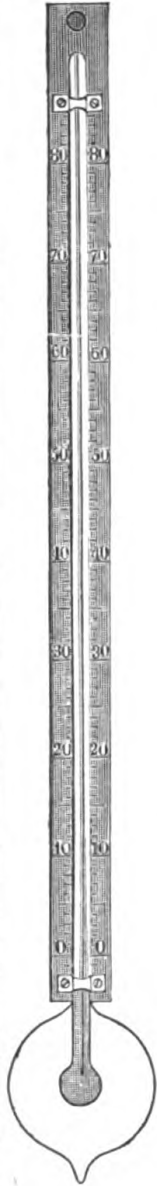

Fig. 2.

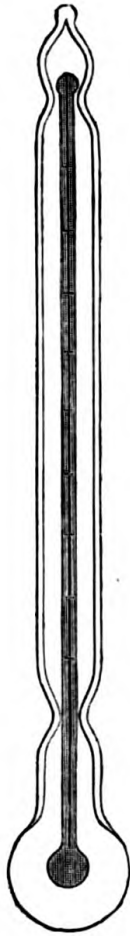

Fig. 3.

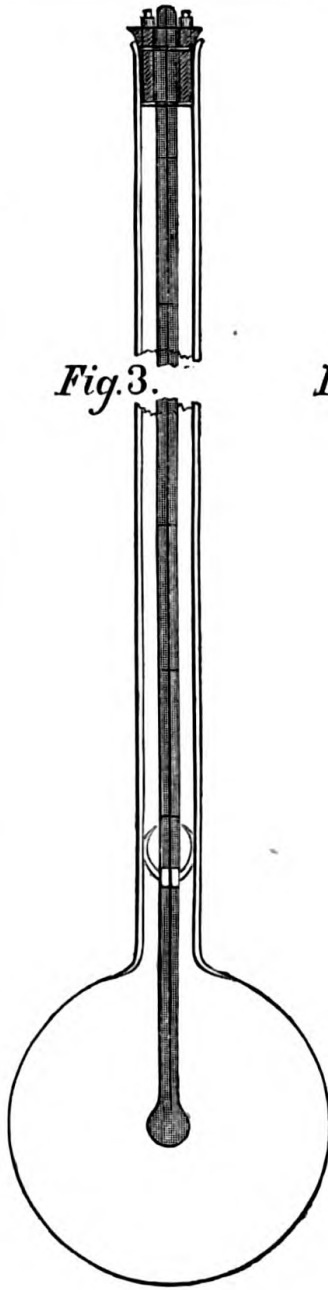
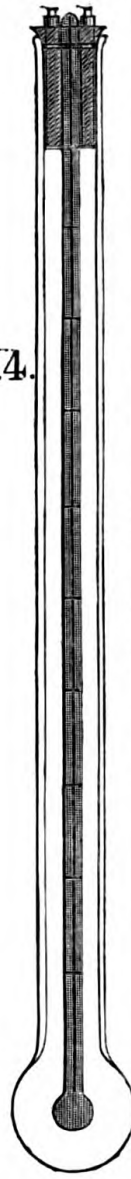
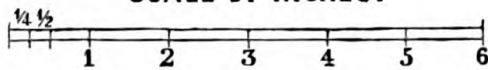

Fig. 4.



SCALE OF INCHES.



OF THE PROPAGATION OF HEAT IN VARIOUS SUBSTANCES.

CHAPTER I.

An Account of the Instruments that were prepared for making the proposed Experiments. — A Thermometer is constructed whose Bulb is surrounded by a TORRICELLIAN VACUUM. — Heat is found to pass in a Torricellian Vacuum with greater Difficulty than in Air. — Relative conducting Powers of a Torricellian Vacuum and of Air with regard to Heat determined by Experiment. — Relative conducting Powers of dry Air and of moist Air. — Relative conducting Powers of Air of different Degrees of Density. — Relative conducting Powers of MERCURY; WATER; AIR; and a TORRICELLIAN VACUUM.

EXAMINING the conducting power of air, and of various other fluid and solid bodies, with regard to Heat, I was led to examine the conducting power of the *Torricellian vacuum*. From the striking analogy between the electric fluid and Heat respecting their conductors and non-conductors (having found that bodies, in general, which are conductors of the electric fluid, are likewise good conductors of Heat, and, on the contrary, that electric bodies, or such as are bad conductors of the electric fluid, are likewise bad conductors of Heat), I was led to imagine that the *Torricellian vacuum*, which

is known to afford so ready a passage to the electric fluid, would also have afforded a ready passage to Heat.

The common experiments of heating and cooling bodies under the receiver of an air-pump I conceive to be inadequate to determining this question; not only on account of the impossibility of making a perfect void of air by means of the pump, but also on account of the moist vapour, which, exhaling from the wet leather and the oil used in the machine, expands under the receiver, and fills it with a watery fluid, which, though extremely rare, is yet capable of conducting a great deal of Heat: I had recourse, therefore, to other contrivances.

I took a thermometer, unfilled, the diameter of whose bulb (which was globular) was just half an inch, Paris measure, and fixed it in the center of a hollow glass ball of the diameter of $1\frac{3}{4}$ Paris inch, in such a manner that, the short neck or opening of the ball being soldered fast to the tube of the thermometer $7\frac{1}{2}$ lines above its bulb, the bulb of the thermometer remained fixed in the center of the ball, and consequently was cut off from all communication with the external air. In the bottom of the glass ball was fixed a small hollow tube or point, which projecting outwards was soldered to the end of a common barometer tube about 32 inches in length, and by means of this opening the space between the internal surface of the glass ball and the bulb of the thermometer was filled with hot mercury, which had been previously freed of air and moisture by boiling. The ball, and also the barometrical tube attached to it, being filled with mercury, the tube was carefully inverted, and its open end placed in a bowl in which there was a quantity of mercury. The instrument now became a barometer, and the mercury descending from the

ball (which was now uppermost) left the space surrounding the bulb of the thermometer free of air. The mercury having totally quitted the glass ball, and having sunk in the tube to the height of 28 inches (being the height of the mercury in the common barometer at that time), with a lamp and a blow-pipe I melted the tube together, or sealed it hermetically, about three quarters of an inch below the ball, and, cutting it at this place with a fine file, I separated the ball from the long barometrical tube. The thermometer being afterwards filled with mercury in the common way, I now possessed a thermometer whose bulb was confined in the center of a *Torricellian vacuum*, and which served at the same time as the body to be heated, and as the instrument for measuring the Heat communicated.

Experiment No. 1.

With this instrument (see Fig. 1) I made the following experiment. Having plunged it into a vessel filled with water, warm to the 18th degree of Reaumur's scale, and suffered it to remain there till it had acquired the temperature of the water, that is to say, till the mercury in the inclosed thermometer stood at 18°, I took it out of this vessel and plunged it suddenly into a vessel of boiling water, and holding it in the water (which was kept constantly boiling) by the end of the tube, in such a manner that the glass ball, in the center of which was the bulb of the thermometer, was just submerged, I observed the number of degrees to which the mercury in the thermometer had arisen at different periods of time, counted from the moment of its immersion. Thus, after it had remained in the boiling water 1 min. 30 sec. I found the mercury had risen from

18° to 27° . After 4 minutes had elapsed, it had risen to $44\frac{9}{10}$; and at the end of 5 minutes it had risen to $48\frac{2}{10}$.

Experiment No. 2.

Taking it now out of the boiling water I suffered it to cool gradually in the air, and after it had acquired the temperature of the atmosphere, which was that of 15° R. (the weather being perfectly fine), I broke off a little piece from the point of the small tube which remained at the bottom of the glass ball, where it had been hermetically sealed, and of course the atmospheric air rushed immediately into the ball. The ball surrounding the bulb of the thermometer being now filled with air (instead of being emptied of air, as it was in the before-mentioned experiment), I resealed the end of the small tube at the bottom of the glass ball hermetically, and by that means cut off all communication between the air confined in the ball and the external air; and with the instrument so prepared I repeated the experiment before mentioned, that is to say, I put it into water warmed to 18° , and when it had acquired the temperature of the water, I plunged it into boiling water, and observed the times of the ascent of the mercury in the thermometer. They were as follows: —

	Time elapsed.	Heat acquired.
Heat at the moment of being plunged into the boiling water		18° R.
After having remained in the boiling water	M S.	°
	0 45	27
	1 0	$34\frac{4}{10}$
	2 10	$44\frac{9}{10}$
	2 40	$48\frac{2}{10}$
	4 0	$56\frac{2}{10}$
	5 0	$60\frac{9}{10}$

From the result of these experiments it appears, evidently, that the Torricellian vacuum, which affords so ready a passage to the electric fluid, so far from being a good conductor of Heat, is a much worse conductor of it than common air, which of itself is reckoned among the worst; for in the last experiment, when the bulb of the thermometer was surrounded with air, and the instrument was plunged into boiling water, the mercury rose from 18° to 27° in 45 seconds; but in the former experiment, when it was surrounded by a Torricellian vacuum, it required to remain in the boiling water 1 minute 30 seconds = 90 seconds, to acquire that degree of heat. In the vacuum it required 5 minutes to rise to $48^{\circ}\frac{2}{10}$; but in air it rose to that height in 2 minutes 40 seconds; and the proportion of the times in the other observations is nearly the same, as will appear by the following table.

		The bulb of the thermometer placed in the center of the glass ball, and			
		surrounded by a Torricellian vacuum. (Exp. No. 1.)		surrounded by air. (Exp. No. 2.)	
		Time elapsed.	Heat acquired.	Time elapsed.	Heat acquired.
Upon being plunged into boiling water	}		18°		18°
After remaining in it		M. S.	o	M. S.	o
		1 30	27	0 45	27
		—	—	1 0	$30\frac{4}{10}$
		4 0	$44\frac{9}{10}$	2 10	$44\frac{9}{10}$
		5 0	$48\frac{2}{10}$	2 40	$48\frac{2}{10}$
		—	—	4 0	$56\frac{2}{10}$
		—	—	5 0	$60\frac{9}{10}$

These experiments were made at Manheim, upon the first day of July, 1785, in the presence of Professor Hemmer, of the Electoral Academy of Sciences of Manheim, and Charles Artaria, meteorological instru-

ment maker to the Academy, by whom I was assisted in making them.

Finding the construction of the instrument made use of in these experiments attended with much trouble and risk, on account of the difficulty of soldering the glass ball to the tube of the thermometer without at the same time either closing up, or otherwise injuring, the bore of the tube, I had recourse to another contrivance much more commodious, and much easier in the execution.

At the end of a glass tube or cylinder about eleven inches in length, and near three quarters of an inch in diameter internally, I caused a hollow globe to be blown $1\frac{1}{2}$ inch in diameter, with an opening in the bottom of it corresponding with the bore of the tube, and equal to it in diameter, leaving to the opening a neck or short tube, about an inch in length. Having a thermometer prepared, whose bulb was just half an inch in diameter, and whose freezing point fell at about $2\frac{3}{4}$ inches above its bulb, I graduated its tube according to Reaumur's scale, beginning at 0° , and marking that point, and also every tenth degree above it to 80° , with threads of fine silk bound round it, which being moistened with lac varnish adhered firmly to the tube. This thermometer I introduced into the glass cylinder and globe just described, by the opening in the bottom of the globe, having first choaked the cylinder at about 2 inches from its junction with the globe by heating it, and crowding its sides inwards towards its axis, leaving only an opening sufficient to admit the tube of the thermometer. The thermometer being introduced into the cylinder in such a manner that the center of its bulb coincided with the center of the globe, I marked a place in the cylinder, about three quarters of an inch above

the 80th degree or boiling point upon the tube of the inclosed thermometer, and taking out the thermometer, I choaked the cylinder again in this place. Introducing now the thermometer for the last time, I closed the opening at the bottom of the globe at the lamp, taking care before I brought it to the fire, to turn the cylinder upside down, and to let the bulb of the thermometer fall into the cylinder till it rested upon the lower choak in the cylinder. By this means the bulb of the thermometer was removed more than 3 inches from the flame of the lamp. The opening at the bottom of the globe being now closed, and the bulb of the thermometer being suffered to return into the globe, the end of the cylinder was cut off to within about half an inch of the upper choak. This being done, it is plain that the tube of the thermometer projected beyond the end of the cylinder. Taking hold of the end of the tube, I placed the bulb of the thermometer as nearly as possible in the center of the globe, and observing and marking a point in the tube immediately above the upper choak of the cylinder, I turned the cylinder upside down, and suffering the bulb of the thermometer to enter the cylinder, and rest upon the first or lower choak, (by which means the end of the tube of the thermometer came further out of the cylinder,) the end of the tube was cut off at the mark just mentioned, (care having first been taken to melt the internal cavity or bore of the tube together at that place,) and a small solid ball of glass, a little larger than the internal diameter or opening of the choak, was soldered to the end of the tube, forming a little button or knob, which resting upon the upper choak of the cylinder served to suspend the thermometer in such a manner that the center of its bulb

coincided with the center of the globe in which it was shut up. The end of the cylinder above the upper choak being now heated and drawn out to a point, or rather being formed into the figure of the frustum of a hollow cone, the end of it was soldered to the end of a barometrical tube, by the help of which the cavity of the cylinder and globe containing the thermometer was completely voided of air with mercury; when, the end of the cylinder being hermetically sealed, the barometrical tube was detached from it with a file, and the thermometer was left completely shut up in a Torricellian vacuum, the centre of the bulb of the thermometer being confined in the centre of the glass globe, without touching it in any part, by means of the two choaks in the cylinder, and the button upon the end of the tube. (See Fig. 2.)

Of these instruments I provided myself with two, as nearly as possible of the same dimensions; the one, which I shall call No. 1, being voided of air, in the manner above described; the other, No. 2, being filled with air, and hermetically sealed.

With these two instruments (see Fig. 2) I made the following experiments upon the 11th of July last at Manheim, between the hours of ten and twelve, the weather being very fine and clear, the mercury in the barometer standing at 27 inches 11 lines, Reaumur's thermometer at 15° , and the quill hygrometer of the Academy of Manheim at 47° .

Experiments No. 3, 4, 5, and 6.

Putting both the instruments into a mixture of pounded ice and water, I let them remain there till the mercury in the inclosed thermometers rested at the

point 0°, that is to say, till they had acquired exactly the temperature of the cold mixture; and then taking them out of it I plunged them suddenly into a large vessel of boiling water, and observed the time required for the mercury to rise in the thermometers from ten degrees to ten degrees, from 0° to 80°, taking care to keep the water constantly boiling during the whole of this time, and taking care also to keep the instruments immersed to the same depth, that is to say, just so deep that the point 0° of the inclosed thermometer was even with the surface of the water.

These experiments I repeated twice with the utmost care; and the following table gives the result of them.

<i>Thermometer No. 1.</i>			<i>Thermometer No. 2.</i>		
Its bulb half an inch in diameter, shut up in the center of a hollow glass globe, 1½ inch in diameter, <i>void of air</i> , and hermetically sealed.			Its bulb half an inch in diameter, shut up in the center of a hollow glass globe, 1½ inch in diameter, <i>filled with air</i> , and hermetically sealed.		
<i>Taken out of freezing water, and plunged into boiling water.</i>			<i>Taken out of freezing water, and plunged into boiling water.</i>		
Time elapsed.		Heat acquired.	Time elapsed.		Heat acquired.
Exp. No. 3.	Exp. No. 4.		Exp. No. 5.	Exp. No. 6.	
M. S.	M. S.	0°	M. S.	M. S.	0°
0 51	0 51	10	0 30	0 30	10
0 59	0 59	20	0 35	0 37	20
1 1	1 2	30	0 41	0 41	30
1 18	1 22	40	0 49	0 53	40
1 24	1 23	50	1 1	0 59	50
2 0	1 51	60	1 24	1 20	60
3 30	3 6	70	2 45	2 25	70
11 41	10 27	80	9 10	9 38	80
22 44	21 1	= total time	16 55	17 3	= total time
of heating from 0° to 80°.			of heating from 0° to 80°.		
Total time from 0° to 70°:			Total time from 0° to 70°:		
M. S.			M. S.		
In Exp. No. 3 = 11 3			In Exp. No. 5 = 7 45		
In Exp. No. 4 = 10 34			In Exp. No. 6 = 7 25		
Medium = 10 48½			Medium = 7 35		

It appears from these experiments that the conducting power of air to that of the Torricellian vacuum, under the circumstances described, is as $7\frac{3}{6}\frac{5}{0}$ to $10\frac{4}{6}\frac{8\frac{1}{2}}{0}$ inversely, or as 1000 to 702 nearly; for, the quantities of Heat communicated being equal, the intensity of the communication is as the times inversely.

In these experiments the Heat passed through the surrounding medium *into* the bulb of the thermometer: in order to reverse the experiment, and make the Heat pass *out of* the thermometer, I put the instruments into boiling water, and let them remain therein till they had acquired the temperature of the water, that is to say, till the mercury in the inclosed thermometers stood at 80° ; and then, taking them out of the boiling water, I plunged them suddenly into a mixture of water and pounded ice, and moving them about continually in this mixture, I observed the times employed in cooling as follows:—

<i>Thermometer No. 1.</i> Surrounded by a Torricellian vacuum. <i>Taken out of boiling water, and plunged into freezing water.</i>			<i>Thermometer No. 2.</i> Surrounded by air. <i>Taken out of boiling water, and plunged into freezing water.</i>		
Time elapsed.		Heat lost.	Time elapsed.		Heat lost.
Exp. No. 7.	Exp. No. 8.		Exp. No. 9.	Exp. No. 10.	
M. S.	M. S.	80°	M. S.	M. S.	80°
1 2	0 54	70	0 33	0 33	70
0 58	1 2	60	0 39	0 34	60
1 17	1 18	50	0 44	0 44	50
1 46	1 37	40	0 55	0 55	40
2 5	2 16	30	1 17	1 18	30
3 14	3 10	20	1 57	1 57	20
5 42	5 59	10	3 44	3 40	10
Not observed.		Not observed.	40 10	Not observed.	0
Total time of cooling from 80° to 10° . M. S.			Total time of cooling from 80° to 10° . M. S.		
In Exp. No. 7 = 16 4			In Exp. No. 9 = 9 49		
In Exp. No. 8 = 16 16			In Exp. No. 10 = 9 41		
Medium = 16 10			Medium = 9 45		

By these experiments it appears that the conducting power of air is to that of the Torricellian vacuum as $9\frac{4}{6}\frac{5}{0}$ to $16\frac{1}{6}\frac{0}{0}$ inversely, or as 1000 to 603.

To determine whether the same law would hold good when the heated thermometers, instead of being plunged into freezing water, were suffered to cool in the open air, I made the following experiments. The thermometers No. 1 and No. 2 being again heated in boiling water, as in the last experiments, I took them out of the water, and suspended them in the middle of a large room, where the air (which appeared to be perfectly at rest, the windows and doors being all shut) was warm to the 16th degree of Reaumur's thermometer, and the times of cooling were observed as follows: —

(Exp. No. 11.) <i>Thermometer No. 1.</i> Surrounded by a Torricellian vacuum. <i>Heated to 80°, and suspended in the open air warm to 16°.</i>		(Exp. No. 12.) <i>Thermometer No. 2.</i> Surrounded by air. <i>Heated to 80°, and suspended in the open air warm to 16°.</i>	
Time elapsed.	Heat lost. 80°	Time elapsed.	Heat lost. 80°
M. S.	°	M. S.	°
Not observed.	70	Not observed.	70
1 24	60	0 51	60
1 44	50	1 5	50
2 28	40	1 34	40
4 16	30	2 41	30
10 12 = total time employed in cooling from 70° to 30°.		6 11 = total time employed in cooling from 70° to 30°.	

Here the difference in the conducting powers of air and of the Torricellian vacuum appears to be nearly the same as in the foregoing experiments, being as $6\frac{1}{6}\frac{1}{0}$ to $10\frac{1}{6}\frac{2}{0}$ inversely, or as 1000 to 605. I could not observe the time of cooling from 80° to 70°, being at that time busied in suspending the instruments.

As it might possibly be objected to the conclusions drawn from these experiments that, notwithstanding all the care that was taken in the construction of the two instruments made use of that they should be perfectly alike, yet they might in reality be so far different, either in shape or size, as to occasion a very sensible error in the result of the experiments; to remove these doubts I made the following experiments:—

In the morning towards eleven o'clock, the weather being remarkably fine, the mercury in the barometer standing at 27 inches 11 lines, Reaumur's thermometer at 15° , and the hygrometer at 47° , I repeated the experiment No. 3 (of heating the thermometer No. 1 in boiling water, &c.), and immediately afterwards opened the cylinder containing the thermometer at its upper end, where it had been sealed, and letting the air into it, I resealed it hermetically, and repeated the experiment again with the same instrument, the thermometer being now surrounded with air, like the thermometer No. 2.

The result of these experiments, which may be seen in the following table, shews evidently that the error arising from the difference of the shapes or dimensions of the two instruments in question was inconsiderable, if not totally imperceptible.

(Exp. No. 13.) <i>Thermometer No. 1.</i>		(Exp. No. 14.) <i>The same Thermometer (No. 1).</i>	
Its bulb half an inch in diameter, shut up in the center of a glass globe, $1\frac{1}{2}$ inch in diameter, void of air, and hermetically sealed.		The glass globe, containing the bulb of the thermometer, being now filled with air, and hermetically sealed.	
<i>Taken out of freezing water and plunged into boiling water.</i>		<i>Taken out of freezing water and plunged into boiling water.</i>	
Time elapsed.	Heat acquired.	Time elapsed.	Heat acquired.
M. S.	0°	M. S.	0°
0 55	10	0 32	10
0 55	20	0 32	20
1 7	30	0 43	30
1 15	40	0 50	40
1 29	50	1 1	50
2 2	60	1 24	60
3 21	70	2 38	70
13 44	80	10 25	80
24 48 = total time of heating from 0° to 80°.		18 5 = total time of heating from 0° to 80°.	
Total time from 0° to 70° = 11' 4".		Total time from 0° to 70° = 7' 40".	

It appears, therefore, from these experiments, that the conducting power of common atmospheric air is to that of the Torricellian vacuum as $7\frac{4}{60}$ to $11\frac{4}{60}$ inversely, or as 1000 to 602; which differs but very little from the result of all the foregoing experiments.

Notwithstanding that it appeared, from the result of these last experiments, that any difference there might possibly have been in the forms or dimensions of the instruments No. 1 and No. 2 could hardly have produced any sensible error in the result of the experiments in question; I was willing, however, to see how far any considerable alterations of size in the instrument would affect the experiment: I therefore provided myself with another instrument, which I shall call *Thermometer No. 3*, different from those already described in size, and a little different in its construction.

The bulb of the thermometer was of the same form and size as in the instruments No. 1 and No. 2, that is to say, it was globular, and half an inch in diameter; but the glass globe, in the center of which it was confined, was much larger, being 3 inches $7\frac{1}{2}$ lines in diameter; and the bore of the tube of the thermometer was much finer, and consequently its length and the divisions of its scale were greater. The divisions were marked upon the tube with threads of silk of different colours at every tenth degree, from 0° to 80° , as in the before-mentioned instruments. The tube or cylinder belonging to the glass globe was 8 lines in diameter, a little longer than the tube of the thermometer, and perfectly cylindrical from its upper end to its junction with the globe, being without any choak; the thermometer being confined in the center of the globe by a different contrivance, which was as follows. To the opening of the cylinder was fitted a stopple of dry wood, covered with a coating of hard varnish, through the centre or axis of which passed the end of the tube of the thermometer; this stopple confined the tube in the axis of the cylinder at its upper end. To confine it at its lower end, there was fitted to it a small steel spring, a little below the point 0° ; which, being fastened to the tube of the thermometer, had three elastic points projecting outwards, which, pressing against the inside of the cylinder, confined the thermometer in its place. The total length of this instrument, from the bottom of the globe to the upper end of the cylinder, was 18 inches, and the freezing point upon the thermometer fell about 3 inches above the bulb; consequently this point lay about $1\frac{1}{2}$ inch above the junction of the cylinder with the globe, when the thermometer was confined in its

place, the center of its bulb coinciding with the center of the globe. Through the stopple which closed the end of the cylinder passed two small glass tubes, about a line in diameter, which being about a line longer than the stopple were closed occasionally with small stopples fitted to their bores. These tubes (which were fitted exactly in the holes bored in the great stopple of the cylinder to receive them, and fixed in their places with cement) served to convey air, or any other fluid, into the glass ball, without its being necessary to remove the stopple closing the end of the cylinder; which stopple, in order to prevent the position of the thermometer from being easily deranged, was cemented in its place.

I have been the more particular in the description of these instruments, as I conceive it to be absolutely necessary to have a perfect idea of them in order to judge of the experiments made with them, and of their results.

With the instrument last described (which I have called *Thermometer No. 3*) I made the following experiment. It was upon the 18th of July, 1785, in the afternoon, the weather variable, alternate clouds and sunshine; wind strong at S. E. with now and then a sprinkling of rain; barometer at 27 inches $10\frac{1}{2}$ lines, thermometer at $18^{\circ}\frac{1}{4}$, and hygrometer variable from 44° to extreme moisture.

In order to compare the result of the experiment made with this instrument with those made with the thermometer No. 2, I have placed together in the same table the different experiments made with them.

(Exp. No. 15.) <i>Thermometer No. 3.</i>		(Exp. No. 5 and No. 6.) <i>Thermometer No. 2.</i>			
Its bulb half an inch in diameter, shut up in the center of a glass tube, 3 inches $7\frac{1}{2}$ lines in diameter, and surrounded by air.		Its bulb half an inch in diameter, shut up in the center of a glass globe, $1\frac{1}{2}$ inch in diameter, and surrounded by air.			
<i>Taken out of freezing water and plunged into boiling water.</i>		<i>Taken out of freezing water and plunged into boiling water.</i>			
		Time elapsed.			Heat acquired
Time elapsed.	Heat acquired.	Exp. No. 5.	Exp. No. 6.	Medium.	
M. S.	0°	M. S.	M. S.	M. S.	0°
0 33	10	0 30	0 30	0 30	10
0 38	20	0 35	0 37	0 36	20
0 54	30	0 41	0 41	0 41	30
0 51	40	0 49	0 53	0 51	40
1 7	50	1 1	0 59	1 0	50
1 28	60	1 24	1 20	1 22	60
2 28	70	2 45	2 25	2 35	70
9 0	80	9 10	9 38	9 24	80
16 59 = total time of heating from 0° to 80°.		16 55	17 3	16 59 = total	time of heating from 0° to 80°.
Time from 0° to 70° = 7' 59".		Time from 0° to 70° = 7' 35".			

If the agreement of these experiments with the thermometers No. 2 and No. 3 surprised me, I was not less surprised with their disagreement in the experiment which follows: —

Experiment No. 16.

Taking the thermometer No. 3 out of the boiling water, I immediately suspended it in the middle of a large room, where the air, which was quiet, was at the temperature of $18^{\circ}\frac{1}{4}$ R. and observed the times of cooling as follows: —

Time elapsed.	Heat lost.
M. S.	80°
1 55	70
0 12	60
0 33	50
2 15	40
4 0	30
9 55 = total time of cooling from 80° to 30°.	

Time from 70° to $30^{\circ} = 8' 0''$; but in the experiment No. 12, with the thermometer No. 2, the time employed in cooling from 70° to 30° was only $6' 11''$. In this experiment, with the thermometer No. 3, the time employed in cooling from 60° to 30° was $7' 48''$; but in the above-mentioned experiment, with the thermometer No. 2 it was only $5' 20''$. It is true, the air of the room was somewhat cooler when the former experiment was made, than when this latter was made, with the thermometer No. 3; but this difference of temperature, which was only $2^{\circ}\frac{1}{4}$ (in the former case the thermometer in the room standing at 16° , and in the latter at $18^{\circ}\frac{1}{4}$), certainly could not have occasioned the whole of the apparent difference in the results of the experiments.

Does air receive Heat more readily than it parts with it? This is a question highly deserving of further investigation, and I hope to be able to give it a full examination in the course of my projected inquiries; but leaving it for the present, I shall proceed to give an account of the experiments which I have already made. Conceiving it to be a step of considerable importance towards coming at a further knowledge of the nature of Heat, to ascertain, by indisputable evidence, its passage through the Torricellian vacuum, and to determine, with as much precision as possible, the law of its motions in that medium; and being apprehensive that doubts might arise with respect to the experiments before described, on account of the contact of the tubes of the inclosed thermometers in the instruments made use of with the containing glass globes, or rather with their cylinders: by means of which (it might be suspected) that a certain quantity, if not all the Heat acquired, might possibly be communicated; to put this matter beyond all doubt, I made the following experiment.

In the middle of a glass body, of a pear-like form, about 8 inches long, and $2\frac{1}{2}$ inches in its greatest diameter, I suspended a small mercurial thermometer, $5\frac{1}{2}$ inches long, by a fine thread of silk, in such a manner that neither the bulb of the thermometer, nor its tube, touched the containing glass body in any part. The tube of the thermometer was graduated, and marked with fine threads of silk of different colours, bound round it, as in the thermometers belonging to the other instruments already described, and the thermometer was suspended in its place by means of a small steel spring, to which the end of the thread of silk which held the thermometer being attached, it (the spring) was forced into a small globular protuberance or cavity, blown in the upper extremity of the glass body, about half an inch in diameter, where, the spring remaining, the thermometer necessarily remained suspended in the axis of the glass body. There was an opening at the bottom of the glass body, through which the thermometer was introduced; and a barometrical tube being soldered to this opening, the inside of the glass body was voided of air by means of mercury; and this opening being afterwards sealed hermetically, and the barometrical tube being taken away, the thermometer was left suspended in a Torricellian vacuum.

In this instrument, as the inclosed thermometer did not touch the containing glass body in any part, on the contrary, being distant from its internal surface an inch or more in every part, it is clear that whatever Heat passed *into* or *out of* the thermometer must have passed *through* the surrounding Torricellian vacuum; for it cannot be supposed that the fine thread of silk, by which the thermometer was suspended, was capable of conduct-

ing any Heat at all, or at least any sensible quantity. I therefore flattered myself with hopes of being able, with the assistance of this instrument, to determine positively with regard to the passage of Heat in the Torricellian vacuum: and this I think I have done, notwithstanding an unfortunate accident that put it out of my power to pursue the experiment so far as I intended.

This instrument being fitted to a small stand or foot of wood, in such a manner that the glass body remained in a perpendicular situation, I placed it in my room, by the side of another inclosed thermometer (No. 2) which was surrounded by air, and observed the effects produced on it by the variation of Heat in the atmosphere. I soon discovered, by the motion of the mercury in the inclosed thermometer, that the Heat passed through the Torricellian vacuum; but it appeared plainly, from the sluggishness or great insensibility of the thermometer, that the Heat passed with much greater difficulty in this medium than in common air. I now plunged both the thermometers into a bucket of cold water; and I observed that the mercury in the thermometer surrounded by air descended much faster than that in the thermometer surrounded by the Torricellian vacuum. I took *them* out of the cold water, and plunged them into a vessel of hot water (having no conveniences at hand to repeat the experiment in due form with the freezing and with the boiling water); and the thermometer surrounded by the Torricellian vacuum appeared still to be much more insensible or sluggish than that surrounded by air.

These trials were quite sufficient to convince me of the passage of Heat in the Torricellian vacuum, and also of the greater difficulty of its passage in that medium

than in common air; but not satisfied to rest my inquiries here, I took the first opportunity that offered, and set myself to repeat the experiments which I had before made with the instruments No. 1 and No. 2. I plunged this instrument into a mixture of pounded ice and water, where I let it remain till the mercury in the inclosed thermometer had descended to 0° ; when, taking it out of this cold mixture, I plunged it suddenly into a vessel of boiling water, and prepared myself to observe the ascent of the mercury in the inclosed thermometer, as in the foregoing experiments; but unfortunately the moment the end of the glass body touched the boiling water, it cracked with the Heat at the point where it had been hermetically sealed, and the water rushing into the body spoiled the experiment: and I have not since had an opportunity of providing myself with another instrument to repeat it.

It having been my intention from the beginning to examine the conducting powers of the artificial airs or gases, the thermometer No. 3 was constructed with a view to those experiments; and having now provided myself with a stock of those different kinds of airs, I began with *fixed air*, with which, by means of water, I filled the globe and cylinder containing the thermometer; and stopping up the two holes in the great stopple closing the end of the cylinder, I exposed the instrument in freezing water till the mercury in the inclosed thermometer had descended to 0° ; when, taking it out of the freezing water, I plunged it into a large vessel of boiling water, and prepared myself to observe the times of heating, as in the former cases; but an accident happened, which suddenly put a stop to the experiment. Immediately upon plunging the instrument into the boiling

water, the mercury began to rise in the thermometer with such uncommon celerity that it had passed the first division upon the tube (which marked the 10th degree, according to Reaumur's scale) before I was aware of its being yet in motion; and having thus missed the opportunity of observing the time elapsed when the mercury arrived at that point, I was preparing to observe its passage of the next, when all of a sudden the stopple closing the end of the cylinder was blown up the chimney with a great explosion, and the thermometer, which, being cemented to it by its tube, was taken along with it, was broken to pieces, and destroyed in its fall.

This unfortunate experiment, though it put a stop for the time to the inquiries proposed, opened the way to other researches not less interesting. Suspecting that the explosion was occasioned by the rarefaction of the water which remained attached to the inside of the globe and cylinder after the operation of filling them with fixed air, and thinking it more than probable that the uncommon celerity with which the mercury rose in the thermometer was principally owing to the same cause, I was led to examine the conducting power of *moist air*, or air saturated with water.

For this experiment I provided myself with a new thermometer No. 4, the bulb of which, being of the same form as those already described (*viz.* globular), was also of the same size, or half an inch in diameter. To receive this thermometer a glass cylinder was provided, 8 lines in diameter, and about 14 inches long, and terminated at one end by a globe $1\frac{1}{2}$ inch in diameter. In the center of this globe the bulb of the thermometer was confined, by means of the stopple which closed the end of the cylinder; which stopple, being near 2 inches

long, received the end of the tube of the thermometer into a hole bored through its center or axis, and confined the thermometer in its place, without the assistance of any other apparatus. Through this stopple two other small holes were bored, and lined with thin glass tubes, as in the thermometer No. 3, opening a passage into the cylinder, which holes were occasionally stopped up with stopples of cork; but to prevent accidents, such as I have before experienced from an explosion, great care was taken not to press these stopples into their places with any considerable force, that they might the more easily be blown out by any considerable effort of the confined air, or vapour.

Though in this instrument the thermometer was not altogether so steady in its place as in the thermometers No. 1, No. 2, and No. 3, the elasticity of the tube, and the weight of the mercury in the bulb of the thermometer, occasioning a small vibration or trembling of the thermometer upon any sudden motion or jar; yet I preferred this method to the others, on account of the lower part of this thermometer being entirely free, or suspended in such a manner as not to touch, or have any communication with, the lower part of the cylinder or the globe; for though the quantity of Heat received by the tube of the thermometer at its contact with the cylinder at its choaks, in the instruments No. 1 and No. 2, or with the branches of the steel spring in No. 3, and from thence communicated to the bulb, must have been exceedingly small; yet I was desirous to prevent even that, and every other possible cause of error or inaccuracy.

Does humidity augment the conducting power of air?

To determine this question I made the following experiments, the weather being clear and fine, the mercury in the barometer standing at 27 inches 8 lines, the thermometer at 19°, and the hygrometer at 44°.

(Exp. No. 17.) <i>Thermometer No. 4.</i>		(Exp. No. 18.) <i>The same Thermometer (No. 4).</i>	
Surrounded by air dry to the 44th degree of the quill hygrometer of the Manheim Academy.		Surrounded by air rendered as moist as possible by wetting the inside of the cylinder and globe with water.	
<i>Taken out of freezing water and plunged into boiling water.</i>		<i>Taken out of freezing water and plunged into boiling water.</i>	
Time elapsed.	Heat acquired.	Time elapsed.	Heat acquired.
M. S.	80°	M. S.	80°
0 34	10	0 6	10
0 39	20	0 4	20
0 44	30	0 5	30
0 51	40	0 9	40
1 6	50	0 18	50
1 35	60	0 26	60
2 40	70	0 43	70
Not observed.	80	7 45	80
8 9 = total time of heating from 0° to 70°		1 51 = total time of heating from 0° to 70°.	

From these experiments it appears that the conducting power of air is very much increased by humidity. To see if the same result would obtain when the experiment was reversed, I now took the thermometer with the *moist air* out of the boiling water, and plunged it into freezing water; and moving it about continually from place to place in the freezing water, I observed the times of cooling, as set down in the following table. N. B. To compare the result of this experiment with those made with *dry air*, I have placed on one side in the following table the experiment in question, and on the other side the experiment No. 10, made with the thermometer No. 2.

(Exp. No. 19.) <i>Thermometer No. 4.</i> Surrounded by moist air. <i>Taken out of boiling water and plunged into freezing water.</i>		(Exp. No. 10.) <i>Thermometer No. 2.</i> Surrounded by dry air. <i>Taken out of boiling water and plunged into freezing water.</i>	
Time elapsed.	Heat lost.	Time elapsed.	Heat lost.
M. S.	80°	M. S.	80°
0 4	70	0 33	70
0 14	60	0 34	60
0 31	50	0 44	50
0 52	40	0 55	40
1 22	30	1 18	30
2 3	20	1 57	20
4 2	10	3 40	10
9 8 = total time of cool- ing from 80° to 10°.		9 41 = total time of cool- ing from 80° to 10°.	

Though the difference of the whole times of cooling from 80° to 10° in these two experiments appears to have been very small, yet the difference of the times taken up by the first twenty or thirty degrees from the boiling point is very remarkable, and shows with how much greater facility Heat passes in moist air than in dry air. Even the slowness with which the mercury in the thermometer No. 4 descended in this experiment from the 30th to the 20th, and from the 20th to the 10th degree, I attribute in some measure to the great conducting power of the moist air with which it was surrounded; for the cylinder containing the thermometer and the moist air being not wholly submerged in the freezing water, that part of it which remained out of the water was necessarily surrounded by the air of the atmosphere; which, being much warmer than the water, communicated of its Heat to the glass; which, passing from thence into the contained moist air as soon as that air became colder than the external air, was, through that medium, communicated to the bulb of the inclosed

thermometer, which prevented its cooling so fast as it would otherwise have done. But when the weather becomes cold, I propose to repeat this experiment with variations, in such a manner as to put the matter beyond all doubt. In the mean time I cannot help observing, with what infinite wisdom and goodness Divine Providence appears to have guarded us against the evil effects of excessive Heat and Cold in the atmosphere; for if it were possible for the air to be equally damp during the severe cold of the winter months as it sometimes is in summer, its conducting power, and consequently its apparent coldness, when applied to our bodies, would be so much increased, by such an additional degree of moisture, that it would become quite intolerable; but, happily for us, its power to hold water in solution is diminished, and with it its power to rob us of our animal heat, in proportion as its coldness is increased. Everybody knows how very disagreeable a very moderate degree of cold is when the air is very damp; and from hence it appears, why the thermometer is not always a just measure of the apparent or sensible Heat of the atmosphere. If colds or catarrhs are occasioned by our bodies being robbed of our animal heat, the reason is plain why those disorders prevail most during the cold autumnal rains, and upon the breaking up of the frost in the spring. It is likewise plain from whence it is that sleeping in damp beds, and inhabiting damp houses, is so very dangerous; and why the evening air is so pernicious in summer and in autumn, and why it is not so during the hard frosts of winter. It has puzzled many very able philosophers and physicians to account for the manner in which the extraordinary degree or rather *quantity* of Heat is generated which an animal

body is supposed to lose, when exposed to the cold of winter, above what it communicates to the surrounding atmosphere in warm summer weather; but is it not more than probable that the difference of the quantities of Heat, actually lost or communicated, is infinitely less than what they have imagined? These inquiries are certainly very interesting; and they are undoubtedly within the reach of well-contrived and well-conducted experiments. But taking my leave for the present of this curious subject of investigation, I hasten to the sequel of my experiments.

Finding so great a difference in the conducting powers of common air and of the Torricellian vacuum, I was led to examine the conducting powers of common air of different degrees of density. For this experiment I prepared the thermometer No. 4, by stopping up one of the small glass tubes passing through the stopple, and opening a passage into the cylinder, and by fitting a valve to the external orifice of the other. The instrument, thus prepared, being put under the receiver of an air-pump, the air passed freely out of the globe and cylinder upon working the machine, but the valve above described prevented its return upon letting air into the receiver. The gage of the air-pump shewed the degree of rarity of the air under the receiver, and consequently of that filling the globe and cylinder, and immediately surrounding the thermometer.

With this instrument, the weather being clear and fine, the mercury in the barometer standing at 27 inches 9 lines, the thermometer at 15° , and the hygrometer at 47° , I made the following experiments.

(Exp. No. 20.) <i>Thermometer No. 4.</i> Surrounded by common air, barometer standing at 27 inches 9 lines. <i>Taken out of freezing water, and plunged into boiling water.</i>		(Exp. No. 21.) <i>Thermometer No. 4.</i> Surrounded by air rarefied by pumping till the barometer-gage stood at 6 inches 11½ lines. <i>Taken out of freezing water, and plunged into boiling water.</i>		(Exp. No. 22.) <i>Thermometer No. 4.</i> Surrounded by air rarefied by pumping till the barometer-gage stood at 1 inch 2 lines. <i>Taken out of freezing water, and plunged into boiling water.</i>	
Time elapsed.	Heat acquired. °	Time elapsed	Heat acquired. °	Time elapsed.	Heat acquired. °
M. S.	°	M. S.	°	M. S.	°
0 31	10	0 31	10	0 29	10
0 40	20	0 38	20	0 36	20
0 41	30	0 44	30	0 49	30
0 47	40	0 51	40	1 1	40
1 4	50	1 7	50	1 1	50
1 25	60	1 19	60	1 24	60
2 28	70	2 27	70	2 31	70
10 17	80	10 21	80	Not observed.	80
7 36 = total time of heating from 0° to 70°.		7 37 = total time of heating from 0° to 70°.		7 51 = total time of heating from 0° to 70°.	

The result of these experiments, I confess, surprised me not a little; but the discovery of truth being the sole object of my inquiries (having no favourite theory to defend) it brings no disappointment along with it, under whatever unexpected shape it may appear. I hope that further experiments may lead to the discovery of the cause why there is so little difference in the conducting powers of air of such very different degrees of rarity, while there is so great a difference in the conducting powers of air, and of the Torricellian vacuum. At present I shall not venture any conjectures upon the subject; but in the mean time I dare to assert that the experiments I have made may be depended on.

The time of my stay at Manheim being expired (having had the honour to attend thither his most Serene Highness the Elector Palatine, reigning Duke of Bavaria, in his late journey) I was prevented from pursu-

ing these inquiries further at that time ; but I shall not fail to recommence them the first leisure moment I can find, which I fancy will be about the beginning of the month of November. In the mean time, to enable myself to pursue them with effect, I am sparing neither labor nor expence to provide a complete apparatus necessary for my purpose ; and his Electoral Highness has been graciously pleased to order M. ARTARIA (who is in his service) to come to Munich to assist me. With such a patron as his most Serene Highness, and with such an assistant as ARTARIA, I shall go on in my pursuits with cheerfulness. Would to God that my labours might be as useful to others as they will be pleasant to me !

I shall conclude this chapter with a short account of some experiments I have made to determine the conducting powers of water and of mercury ; and with a table, showing at one view the conducting powers of all the different mediums which I have examined.

Having filled the glass globe inclosing the bulb of the thermometer No. 4, first with water, and then with mercury, I made the following experiments, to ascertain the conducting powers of those two fluids.

(Exp. No. 23.) Thermometer No. 4. Surrounded by water. <i>Taken out of freezing water, and plunged into boiling water.</i>		(Exp. No. 24, 25, and 26.) Thermometer No. 4. Surrounded by mercury. <i>Taken out of freezing water, and plunged into boiling water.</i>			
Time elapsed.		Time elapsed.			Heat acquired.
M. S.	Heat acquired.	Exp. No. 24.	Exp. No. 25.	Exp. No. 26.	
	0°				0°
0 19	10	0 5	0 5	0 5	10
0 8	20	0 4	0 2	0 5	20
0 9	30	0 2	0 2	0 4	30
0 11	40	0 4	0 5	0 5	40
0 15	50	0 4	0 4	0 7	50
0 21	60	0 7	0 4	0 8	60
0 34	70	0 15	0 9	0 14	70
2 13	80	Not observed.	0 58	Not observed.	80
1 57 = total time of heating from 0° to 70°.		0 41	0 31	0 48 = total times of heating from 0° to 70°.	

The total times of heating from 0° to 70° in the three experiments with mercury being 41 seconds, 31 seconds, and 48 seconds, the mean of these times is 40 seconds; and as in the experiment with water the time employed in acquiring the same degree of Heat was 1' 57" = 117 seconds, it appears from these experiments that the conducting power of mercury to that of water, under the circumstances described, is as 36 $\frac{2}{3}$ to 117 inversely, or as 1000 to 342. And hence it is plain, why mercury *appears* so much hotter, and so much colder, to the touch than water, when in fact it is of the same temperature: for the force or violence of the sensation of what appears *hot* or *cold* depends not entirely upon the temperature of the body exciting in us those sensations, or upon the degree of Heat it actually possesses, but upon the *quantity* of Heat it is capable of communicating to us, or receiving from us, in any given short period of time, or as the intensity of the communica-

tion; and this depends in a great measure upon the conducting powers of the bodies in question.

The sensation excited in us when we touch anything that appears to us to be *hot* is the entrance of heat into our bodies; that of *cold* is its exit; and whatever contributes to facilitate or accelerate this communication adds to the violence of the sensation. And this is another proof that the thermometer cannot be a just measure of the intensity of the *sensible* Heat, or Cold, existing in bodies; or rather, that the touch does not afford us a just indication of their *real* temperatures.

A TABLE of the CONDUCTING POWERS of the under-mentioned MEDIUMS as determined by the foregoing Experiments.

Therm. No. 1.		Thermometer No. 4.					
<i>Taken out of freezing water and plunged into boiling water.</i>							
Time elapsed.							
Torriceilian Vacuum (Exp. No. 3, 4, and 13).	Common air, density = 1 (Exp. No. 20).	Rarefied air, density = $\frac{1}{4}$ (Exp. No. 21).	Rarefied air, density = $\frac{1}{8}$ (Exp. No. 22).	Moist air (Exp. No. 18).	Water. (Exp. No. 23).	Mercury (Exp. No. 24, 25, and 26).	Heat acquired.
M. S.	M. S.	M. S.	M. S.	M. S.	M. S.	M. S.	°
0 52	0 31	0 31	0 29	0 6	0 19	0 5	10
0 58	0 40	0 38	0 36	0 4	0 8	0 3 $\frac{3}{4}$	20
1 3	0 41	0 44	0 49	0 5	0 9	0 2 $\frac{3}{4}$	30
1 18	0 47	0 51	1 1	0 9	0 11	0 4 $\frac{3}{4}$	40
1 25	1 4	1 7	1 1	0 18	0 15	0 5	50
1 58	1 25	1 19	1 24	0 26	0 21	0 6 $\frac{1}{4}$	60
3 19	2 28	2 27	2 31	0 43	0 34	0 12 $\frac{3}{4}$	70
11 57	10 17	10 21	—	7 45	2 13	0 58	80
10 53	7 36	7 37	7 51	1 51	1 57	0 40	total times of heating from 0° to 70°.

In determining the relative conducting powers of these mediums, I have compared the times of the heating of the thermometer from 0° to 70° instead of taking the whole times from 0° to 80° , and this I have done on account of the small variation in the Heat of the boiling water arising from the variation of the weight of the atmosphere, and also on account of the very slow motion of the mercury between the 70th and the 80th degrees, and the difficulty of determining the precise moment when the mercury arrives at the 80th degree.

Taking now the conducting power of mercury = 1000, the conducting powers of the other mediums, as determined by these experiments, will be as follows, *viz.* :—

Mercury	1000
Moist air	330
Water	313
Common air, density = 1	$80\frac{41}{100}$
Rarefied air, density = $\frac{1}{4}$	$80\frac{23}{100}$
Rarefied air, density = $\frac{1}{24}$	78
The Torricellian vacuum	55

And in these proportions are the quantities of Heat which these different mediums are capable of transmitting in any given time; and consequently these numbers express the relative *sensible* temperatures of the mediums, as well as their conducting powers. How far these decisions will hold good under a variation of circumstances, experiment only can determine. This is certainly a subject of investigation not less curious in itself than it is interesting to mankind; and I wish that what I have done may induce others to turn their attention to this long neglected field of experimental inquiry. For my own part I am determined not to quit it.

In the further prosecution of these inquiries, I do not mean to confine myself solely to the determining of the conducting powers of Fluids; on the contrary, solids, and particularly such bodies as are made use of for cloathing, will be principal subjects of my future experiments. I have indeed already begun these researches, and have made some progress in them; but I forbear to anticipate a matter which will be the subject of a future communication.

CHAPTER II.

The relative Warmth of various Substances used in making artificial Cloathing, determined by Experiment. — Relative Warmth of Coverings of the same Thickness, and formed of the same Substance, but of different Densities. — Relative Warmth of Coverings formed of equal Quantities of the same Substance, disposed in different Ways. — Experiments made with a View to determining how far the Power which certain Bodies possess of confining Heat depends on their chymical Properties. — Experiments with Charcoal — with Lampblack — with Wood-ashes — Striking Experiments with Semen Lycopodii. — All these Experiments indicate that the Air which occupies the Interstices of Substances used in forming Coverings for confining Heat, acts a very important Part in that Operation. — Those Substances appear to prevent the Air from conducting the Heat. — An Inquiry concerning the Manner in which this is effected. — This Inquiry leads to a decisive Experiment from the Result of which it appears that Air is a perfect Non-conductor of Heat. — This Discovery affords the

means of explaining a variety of interesting Phenomena in the Economy of Nature.

THE confining and directing of Heat are objects of such vast importance in the economy of human life, that I have been induced to confine my researches chiefly to those points, conceiving that very great advantages to mankind could not fail to be derived from the discovery of any new facts relative to these operations.

If the laws of the communication of Heat from one body to another were known, measures might be taken with certainty, in all cases, for confining it, and directing its operations, and this would not only be productive of great economy in the articles of fuel and cloathing, but would likewise greatly increase the comforts and conveniences of life, — objects of which the philosopher should never lose sight.

The route which I have followed in this inquiry is that which I thought bid fairest to lead to useful discoveries. Without embarrassing myself with any particular theory, I have formed to myself a plan of experimental investigation, which I conceived would conduct me to the knowledge of *certain facts*, of which we are now ignorant, or very imperfectly informed, and with which it is of consequence that we should be made acquainted.

The first great object which I had in view in this inquiry was to ascertain, if possible, the cause of the warmth of certain bodies, or the circumstances upon which their power of confining Heat depends. This, in other words, is no other than to determine the cause of the conducting and non-conducting power of bodies, with regard to Heat.

To this end, I began by determining by actual experiment the relative conducting powers of various bodies of very different natures, both fluids and solids; of some of which experiments I have already given an account in the paper above mentioned, which is published in the Transactions of the Royal Society for the year 1786: I shall now, taking up the matter where I left it, give the continuation of the history of my researches.

Having discovered that the Torricellian vacuum is a much worse conductor of Heat than common air, and having ascertained the relative conducting powers of air, of water, and of mercury, under different circumstances, I proceeded to examine the conducting powers of various *solid bodies*, and particularly of such substances as are commonly made use of for cloathing.

The method of making these experiments was as follows: a mercurial thermometer (see Fig. 4), whose bulb was about $\frac{5.5}{100}$ of an inch in diameter, and its tube about 10 inches in length, was suspended in the axis of a cylindrical glass tube, about $\frac{3}{4}$ of an inch in diameter, ending with a globe $1\frac{6}{10}$ inch in diameter, in such a manner that the center of the bulb of the thermometer occupied the center of the globe; and the space between the internal surface of the globe and the surface of the bulb of the thermometer being filled with the substance whose conducting power was to be determined, the instrument was heated in boiling water, and afterwards, being plunged into a freezing mixture of pounded ice and water, the times of cooling were observed, and noted down.

The tube of the thermometer was divided at every tenth degree from 0° , or the point of freezing, to 80° , that of boiling water; and these divisions being marked

upon the tube with the point of a diamond, and the cylindrical tube being left empty, the height of the mercury in the tube of the thermometer was seen through it.

The thermometer was confined in its place by means of a stopple of cork, about $1\frac{1}{2}$ inch long, fitted to the mouth of the cylindrical tube, through the center of which stopple the end of the tube of the thermometer passed, and in which it was cemented.

The operation of introducing into the globe the substances whose conducting powers are to be determined, is performed in the following manner: the thermometer being taken out of the cylindrical tube, about two thirds of the substance which is to be the subject of the experiment are introduced into the globe; after which, the bulb of the thermometer is introduced a few inches into the cylinder; and, after it, the remainder of the substance being placed round about the tube of the thermometer; and, lastly, the thermometer being introduced farther into the tube, and being brought into its proper place, that part of the substance which, being introduced last, remains in the cylindrical tube above the bulb of the thermometer, is pushed down into the globe, and placed equally round the bulb of the thermometer by means of a brass wire which is passed through holes made for that purpose in the stopple closing the end of the cylindrical tube.

As this instrument is calculated merely for measuring the passage of Heat in the substance whose conducting power is examined, I shall give it the name of *passage-thermometer*, and I shall apply the same appellation to all other instruments constructed upon the same principles, and for the same use, which I may in future have

occasion to mention ; and as this instrument has been so particularly described, both here, and in my former paper upon the subject of Heat, in speaking of any others of the same kind in future it will not be necessary to enter into such minute details. I shall, therefore, only mention their *sizes*, or the diameters of their bulbs, the diameters of their globes, the diameters of their cylinders, and the lengths and divisions of their tubes, taking it for granted that this will be quite sufficient to give a clear idea of the instrument.

In most of my former experiments, in order to ascertain the conducting power of any body, the body being introduced into the globe of the passage-thermometer, the instrument was cooled to the temperature of freezing water, after which, being taken out of the ice-water, it was plunged suddenly into boiling water, and the times of heating from ten to ten degrees were observed and noted ; and I said that these times were as the conducting power of the body inversely ; but in the experiments of which I am now about to give an account, I have in general reversed the operation ; that is to say, instead of observing the times of heating, I have first heated the body in boiling water, and then plunging it into a mixture of pounded ice and ice-cold water, I have noted the times taken up in cooling.

I have preferred this last method to the former, not only on account of the greater ease and convenience with which a thermometer, plunged into ice and water, may be observed, than when placed in a vessel of boiling water, and surrounded by hot steam, but also on account of the greater accuracy of the experiment, the heat of boiling water varying with the variations of the pressure of the atmosphere ; consequently, the ex-

periments made upon different days will have different results, and of course, strictly speaking, cannot be compared together; but the temperature of pounded ice and water is ever the same, and of course the results of the experiments are uniform.

In heating the thermometer, I did not in general bring it to the temperature of the boiling water, as this temperature, as I have just observed, is variable; but when the mercury had attained the 75° of its scale, I immediately took it out of the boiling water, and plunged it into the ice and water; or, which I take to be still more accurate, suffering the mercury to rise a degree or two above 75° , and then taking it out of the boiling water, I held it over the vessel containing the pounded ice and water, ready to plunge it into that mixture the moment the mercury, descending, passes the 75° .

Having a watch at my ear which beat half seconds (which I counted), I noted the time of the passage of the mercury over the divisions of the thermometer, marking 70° and every tenth degree from it, descending to 10° of the scale. I continued the cooling to 0° , or the temperature of the ice and water, in very few instances, as this took up much time, and was attended with no particular advantage, the determination of the times taken up in cooling 60 degrees of Reaumur's scale — that is to say, from 70° to 10° — being quite sufficient to ascertain the conducting power of any body whatever.

During the time of cooling in ice and water, the thermometer was constantly moved about in this mixture from one place to another; and there was always so much pounded ice mixed with the water that the ice appeared above the surface of the water, — the vessel, which

was a large earthen jar, being first quite filled with pounded ice, and the water being afterwards poured upon it, and fresh quantities of pounded ice being added as the occasion required.

Having described the apparatus made use of in these experiments, and the manner of performing the different operations, I shall now proceed to give an account of the experiments themselves.

My first attempt was to discover the relative conducting powers of such substances as are commonly made use of for cloathing; accordingly, having procured a quantity of *raw silk*, as spun by the worm, *sheep's-wool*, *cotton-wool*, *linen* in the form of the finest lint, being the scrapings of very fine Irish linen, the finest part of the *fur of the beaver* separated from the skin, and from the long hair, the finest part of the *fur of a white Russian hare*, and *eider-down*, — I introduced successively 16 grains in weight of each of these substances into the globe of the passage-thermometer, and placing it carefully and equally round the bulb of the thermometer, I heated the thermometer in boiling water, as before described, and taking it out of the boiling water, plunged it into pounded ice and water, and observed the times of cooling.

But as the interstices of these bodies thus placed in the globe were filled with air, I first made the experiment with air alone, and took the result of that experiment as a standard by which to compare all the others; the results of three experiments with air were as follows : —

The Bulb of the Thermometer surrounded by Air.				
Heat lost.	Exp. No. 1.	Exp. No. 2.	Heat acquired.	Exp. No. 3.
	Time elapsed.	Time elapsed.		Time elapsed.
70°	—	—	10°	—
60	38"	38'	20	39"
50	46	46	30	43
40	59	59	40	53
30	80	79	50	67
20	122	122	60	96
10	231	230	70	175
Total times	576	574	—	473

The following table shews the results of the experiments with the various substances therein mentioned : —

Heat lost.	Air.	Raw silk, 16 grs.	Sheep's-wool, 16 grs.	Cotton-wool, 16 grs.	Fine lint, 16 grs.	Beavers' fur, 16 grs.	Hares' fur, 16 grs.	Eider-down, 16 grs.
	Exp. 1.	Exp. 4.	Exp. 5.	Exp. 6.	Exp. 7.	Exp. 8.	Exp. 9.	Exp. 10.
70°	—	—	—	—	—	—	—	—
60	38"	94"	79"	83"	80"	99"	97'	98"
50	46	110	95	95	93	116	117	116
40	59	133	118	117	115	153	144	146
30	80	185	162	152	150	185	193	192
20	122	273	238	221	218	265	270	268
10	231	489	426	378	376	478	494	485
Total times	576	1284	1118	1046	1032	1296	1315	1305

Now the *warmth* of a body, or its power to confine Heat, being as its power of resisting the passage of Heat through it (which I shall call its *non-conducting power*); and the time taken up by any body in cooling, which is surrounded by any medium through which the Heat is obliged to pass, being, *ceteris paribus*, as the resistance which the medium opposes to the passage of

the Heat, it appears that the *warmth* of the bodies mentioned in the foregoing table are as the times of cooling, — the *conducting powers* being inversely as those times, as I have formerly shown.

From the results of the foregoing experiments it appears that, of the seven different substances made use of, hares' fur and eider-down were the warmest; after these came beavers' fur, raw silk, sheep's-wool, cotton-wool, and, lastly, lint, or the scrapings of fine linen; but I acknowledge that the differences in the warmth of these substances were much less than I expected to have found them.

Suspecting that this might arise from the volumes or solid contents of the substances being different (though their weights were the same), arising from the difference of their specific gravities; and as it was not easy to determine the specific gravities of these substances with accuracy, in order to see how far any known difference in the volume or quantity of the same substance, confined always in the same space, would add to or diminish the time of cooling, or the apparent warmth of the covering, I made the three following experiments.

In the first, the bulb of the thermometer was surrounded by 16 grains of eider-down; in the second by 32 grains; and in the third by 64 grains; and in all these experiments the substance was made to occupy exactly the same space, viz. the whole internal capacity of the glass globe, in the center of which the bulb of the thermometer was placed; consequently, the thickness of the covering of the thermometer remained the same, while its density was varied in proportion to the numbers 1, 2, and 4.

The results of these experiments were as follows: —

The Bulb of the Thermometer being surrounded by Eider-down.			
Heat lost.	16 grains.	32 grains.	64 grains.
	(Exp. No. 11.)	(Exp. No. 12.)	(Exp. No. 13.)
70°	—	—	—
60	97"	111"	112"
50	117	128	130
40	145	157	165
30	192	207	224
20	267	304	326
10	486	565	658
Total times	1304	1472	1615

Without stopping at present to draw any particular conclusions from the results of these experiments, I shall proceed to give an account of some others, which will afford us a little further insight into the nature of some of the circumstances upon which the warmth of covering depends.

Finding, by the last experiments, that the density of the covering added so considerably to the warmth of it, its thickness remaining the same, I was now desirous of discovering how far the internal structure of it contributed to render it more or less pervious to Heat, its thickness and quantity of matter remaining the same. By internal structure, I mean the disposition of the parts of the substance which forms the covering; thus they may be extremely divided, or very fine, as raw silk as spun by the worms, and they may be equally distributed through the whole space they occupy; or they may be coarser, or in larger masses, with larger interstices, as the ravelings of cloth, or cuttings of thread.

If Heat passed *through* the substances made use of for covering, and if the warmth of the covering depended solely upon the difficulty which the Heat meets

with in its passage through the substances, *or solid parts*, of which they are composed, — in that case, the warmth of covering would be always, *cæteris paribus*, as the quantity of materials of which it is composed; but that this is not the case, the following, as well as the foregoing, experiments clearly evince.

Having, in the experiment No. 4, ascertained the warmth of 16 grains of raw silk, I now repeated the experiment with the same quantity, or weight, of the ravelings of white taffety, and afterwards with a like quantity of common sewing-silk, cut into lengths of about two inches.

The following table shows the results of these three experiments: —

Heat lost.	Raw silk, 16 grs.	Ravelings of taffety, 16 grs.	Sewing-silk cut into lengths, 16 grs.
	Exp. 4.	Exp. 14.	Exp. 15.
70°	—	—	—
60	94"	90"	67"
50	110	106	79
40	133	128	99
30	185	172	135
20	273	246	195
10	489	427	342
Total times	1284	1169	917

Here, notwithstanding that the quantities of the silk were the same in the three experiments, and though in each of them it was made to occupy the same space, yet the warmth of the coverings which were formed were very different, owing to the different disposition of the material.

The raw silk was very fine, and was very equally distributed through the space it occupied, and it formed a warm covering.

The ravelings of taffety were also fine, but not so fine as the raw silk, and of course the interstices between its threads were greater, and it was less warm; but the cuttings of sewing-silk were very coarse, and consequently it was very unequally distributed in the space in which it was confined; and it made a very bad covering for confining Heat.

It is clear from the results of the five last experiments, that the air which occupies the interstices of bodies, made use of for covering, acts a very important part in the operation of confining Heat; yet I shall postpone the examination of that circumstance till I shall have given an account of several other experiments, which, I think, will throw still more light upon that subject.

But, before I go any further, I will give an account of three experiments, which I made, or, rather, the same experiment which I repeated three times the same day, in order to see how far they may be depended on, as being regular in their results.

The glass globe of the passage-thermometer being filled with 16 grains of cotton-wool, the instrument was heated and cooled three times successively, when the times of cooling were observed as follows: —

Heat lost.	Exp. 16.	Exp. 17.	Exp. 18.
70°	—	—	—
60	82"	84"	83"
50	96	95	95
40	118	117	116
30	152	153	151
20	221	221	220
10	380	377	377
Total times	1049	1047	1042

The differences of the times of cooling in these three experiments were extremely small ; but regular as these experiments appear to have been in their results, they were not more so than the other experiments made in the same way, many of which were repeated two or three times, though, for the sake of brevity, I have put them down as single experiments.

But to proceed in the account of my investigations relative to the causes of the warmth of warm cloathing. Having found that the fineness and equal distribution of a body or substance made use of to form a covering to confine Heat contributes so much to the warmth of the covering, I was desirous, in the next place, to see the effect of condensing the covering, its quantity of matter remaining the same, but its thickness being diminished in proportion to the increase of its density.

The experiment I made for this purpose was as follows : I took 16 grains of common sewing-silk, neither very fine nor very coarse, and winding it about the bulb of the thermometer in such a manner that it entirely covered it, and was as nearly as possible of the same thickness in every part, I replaced the thermometer in its cylinder and globe, and heating it in boiling water, cooled it in ice and water, as in the foregoing experiments. The results of the experiment were as may be

seen in the following table; and in order that it may be compared with those made with the same quantity of silk differently disposed of, I have placed those experiments by the side of it : —

Heat lost.	Raw silk, 16 grs.	Fine ravelings of taffety, 16 grs.	Sewing-silk cut into lengths, 16 grs.	Sewing-silk, 16 grs. wound round the bulb of the thermometer.
	Exp. No. 4.	Exp. No. 14.	Exp. No. 15.	Exp. No. 19.
70°	—	—	—	—
60	94"	90"	67"	46"
50	110	106	79	62
40	133	128	99	85
30	185	172	135	121
20	273	246	195	191
10	489	427	342	399
Total times.	1284	1169	917	904

It is not a little remarkable, that, though the covering formed of sewing-silk wound round the bulb of the thermometer in the 19th experiment appeared to have so little power of confining the Heat when the instrument was very hot, or when it was first plunged into the ice and water, yet afterwards, when the Heat of the thermometer approached much nearer to that of the surrounding medium, its power of confining the Heat which remained in the bulb of the thermometer appeared to be even greater than that of the silk in the experiment No. 15, the time of cooling from 20° to 10° being in the one 399", and in the other 342". The same appearance was observed in the following experiments, in which the bulb of the thermometer was surrounded by threads of *wool*, of *cotton*, and of *linen*, or *flax*, wound round it, in

the like manner as the sewing-silk was wound round it in the last experiment.

The following table shows the results of these experiments, with the threads of various kinds; and that they may the more easily be compared with those made with the same quantity of the same substances in a different form, I have placed the accounts of these experiments by the side of each other. I have also added the account of an experiment, in which 16 grains of fine linen cloth were wrapped round the bulb of the thermometer, going round it nine times, and being bound together at the top and bottom of it, so as completely to cover it.

Heat lost.	<i>Sheep's-wool</i> , 16 grains, surrounding the bulb of the thermometer.	<i>Woolen thread</i> , 16 grains, wound round the bulb of the thermometer.	<i>Cotton-wool</i> , 16 grains, surrounding the bulb of the thermometer.	<i>Cotton thread</i> , 16 grains, wound round the bulb of the thermometer.	<i>Lint</i> , 16 grains, surrounding the bulb of the thermometer.	<i>Linen thread</i> , 16 grains, wound round the bulb of the thermometer.	<i>Linen cloth</i> , 16 grains, wrapped round the bulb of the thermometer.
	Exp. 5.	Exp. 20.	Exp. 6.	Exp. 21.	Exp. 7.	Exp. 22.	Exp. 23.
70°	—	—	—	—	—	—	—
60	79"	46"	83"	45"	80"	46"	42"
50	95	63	95	60	93	62	56
40	118	89	117	83	115	83	74
30	162	126	152	115	150	117	108
20	238	200	221	179	218	180	168
10	426	410	378	370	376	385	338
Total times	1118	934	1046	852	1032	873	783

That thread wound tight round the bulb of the thermometer should form a covering less warm than the same quantity of wool, or other raw materials of which the thread is made, surrounding the bulb of the thermometer in a more loose manner, and consequently oc-

cupying a greater space, is no more than what I expected, from the idea I had formed of the causes of the warmth of covering; but I confess I was much surprised to find that there is so great a difference in the relative warmth of these two coverings, when they are employed to confine great degrees of Heat, and when the Heat they confine is much less in proportion to the temperature of the surrounding medium. This difference was very remarkable; in the experiments with sheep's-wool, and with woollen thread, the warmth of the covering formed of 16 grains of the former was to that formed of 16 grains of the latter, when the bulb of the thermometer was heated to 70° and cooled to 60° , as 79 to 46 (the surrounding medium being at 0°); but afterwards, when the thermometer had only fallen from 20° to 10° of Heat, the warmth of the wool was to that of the woollen thread only as 426 to 410; and in the experiments with lint, and with linen thread, when the Heat was much abated, the covering of the thread appeared to be even warmer than that of the lint, though in the beginning of the experiments, when the Heat was much greater, the lint was warmer than the thread, in the proportion of 80 to 46.

From hence it should seem that a covering may, under certain circumstances, be very good for confining small degrees of warmth, which would be but very indifferent when made use of for confining a more intense Heat, and *vice versa*. This, I believe, is a new fact; and I think the knowledge of it may lead to further discoveries relative to the causes of the warmth of coverings, or the manner in which Heat makes its passage through them. But I forbear to enlarge upon this subject, till I shall have given an account of several other

experiments, which I think throw more light upon it, and which will consequently render the investigation easier and more satisfactory.

With a view to determine how far the power which certain bodies appear to possess of confining Heat, when made use of as covering, depends upon the natures of those bodies, considered as chymical substances, or upon the chymical principles of which they are composed, I made the following experiments.

As charcoal is supposed to be composed almost entirely of phlogiston, I thought that, if that principle was the cause either of the conducting power or the non-conducting power of the bodies which contain it, I should discover it by making the experiment with charcoal, as I had done with various other bodies. Accordingly, having filled the globe of the passage-thermometer with 176 grains of that substance in very fine powder (it having been pounded in a mortar, and sifted through a fine sieve), the bulb of the thermometer being surrounded by this powder, the instrument was heated in boiling water, and being afterwards plunged into a mixture of pounded ice and water, the times of cooling were observed as mentioned in the following table. I afterwards repeated the experiment with lampblack, and with very pure and very dry wood-ashes; the results of which experiments were as under mentioned: —

The Bulb of the Thermometer surrounded by				
Heat lost.	176 grains of fine powder of charcoal.	176 grains of fine powder of charcoal.	195 grains of lampblack.	307 grains of pure dry wood-ashes.
	Exp. No. 24.	Exp. No. 25.	Exp. No. 26.	Exp. No. 27.
70°	—	—	—	—
60	79''	91''	124''	96''
50	95	91	118	92
40	100	109	134	107
30	139	133	164	136
20	196	192	237	185
10	331	321	394	311
Total times	940	937	1171	927

The experiment No. 25 was simply a repetition of that numbered 24, and was made immediately after it; but, in moving the thermometer about in the former experiment, the powder of charcoal which filled the globe was shaken a little together, and to this circumstance I attribute the difference in the results of the two experiments.

In the experiments with lampblack and with wood-ashes, the times taken up in cooling from 70° to 60° were greater than those employed in cooling from 60° to 50°; this most probably arose from the considerable quantity of Heat contained by these substances, which was first to be disposed of, before they could receive and communicate to the surrounding medium that which was contained by the bulb of the thermometer.

The next experiment I made was with *semen lycopodii*, commonly called witch-meal, a substance which possesses very extraordinary properties. It is almost impossible to wet it; a quantity of it strewed upon the surface of a basin of water, not only swims upon the water without being wet, but it prevents other bodies from being wet which are plunged into the water through it; so that a piece of money, or other solid body, may be taken from

the bottom of the basin by the naked hand without wetting the hand; which is one of the tricks commonly shown by the jugglers in the country: this meal covers the hand, and, descending along with it to the bottom of the basin, defends it from the water. This substance has the appearance of an exceeding fine, light, and very moveable yellow powder, and it is very inflammable; so much so, that, being blown out of a quill into the flame of a candle, it flashes like gunpowder, and it is made use of in this manner in our theatres for imitating lightning.

Conceiving that there must have been a strong attraction between this substance and air, and suspecting, from some circumstances attending some of the foregoing experiments, that the warmth of a covering depends not merely upon the fineness of the substance of which the covering is formed, and the disposition of its parts, but that it arises in some measure from a certain attraction between the substance and the air which fills its interstices, I thought that an experiment with *semen lycopodii* might possibly throw some light upon this matter; and in this opinion I was not altogether mistaken, as will appear by the results of the three following experiments.

Heat lost.	Cooled.		Heat acquired.	Heated.	
	Exp. No. 28.	Exp. No. 29.		Exp. No. 30.	
70°	—	—	0°	—	
60	146''	157''	10	230''	
50	162	160	20	68	
40	175	170	30	63	
30	209	203	40	76	
20	284	288	50	121	
10	502	513	60	316	
—	—	—	70	1585	
Total times	1478	1491	—	2459	

In the last experiment (No. 30), the result of which was so very extraordinary, the instrument was cooled to 0° in thawing ice, after which it was plunged suddenly into boiling water, where it remained till the inclosed thermometer had acquired the Heat of 70° , which took up no less than 2459 seconds, or above 40 minutes; and it had remained in the boiling water full a minute and a half before the mercury in the thermometer showed the least sign of rising. Having at length been put into motion, it rose very rapidly 40 or 50 degrees, after which its motion gradually abating became so slow, that it took up 1585 seconds, or something more than 26 minutes, in rising from 60° to 70° , though the temperature of the medium in which it was placed during the whole of this time was very nearly 80° ; the mercury in the barometer standing but little short of 27 Paris inches.

All the different substances which I had yet made use of in these experiments for surrounding or covering the bulb of the thermometer, fluids excepted, had, in a greater or in a less degree confined the Heat, or prevented its passing into or out of the thermometer so rapidly as it would have done, had there been nothing but air in the glass globe, in the center of which the bulb of the thermometer was suspended. But the great question is, how, or in what manner, they produced this effect?

And first, it was not in consequence of their own non-conducting powers, simply considered; for if, instead of being only bad conductors of Heat, we suppose them to have been totally impervious to Heat, their volumes or solid contents were so exceedingly small in proportion to the capacity of the globe in which they

were placed, that, had they had no effect whatever upon the air filling their interstices, that air would have been sufficient to have conducted all the Heat communicated in less time than was actually taken up in the experiment.

The diameter of the globe being 1.6 inches, its contents amounted to 2.14466 cubic inches; and the contents of the bulb of the thermometer being only 0.08711 of a cubic inch (its diameter being 0.55 of an inch), the space between the bulb of the thermometer and the internal surface of the globe amounted to $2.14466 - 0.08711 = 2.05755$ cubic inches; the whole of which space was occupied by the substances by which the bulb of the thermometer was surrounded in the experiments in question.

But though these substances occupied this space, they were far from *filling it*; by much the greater part of it being filled by the air which occupied the interstices of the substances in question. In the experiment No. 4, this space was occupied by 16 grains of raw silk; and as the specific gravity of raw silk is to that of water as 1734 to 1000, the volume of this silk was equal to the volume of 9.4422 grains of water; and as 1 cubic inch of water weighs 253.185 grains, its volume was equal to $\frac{9.4422}{253.185} = 0.037294$ of a cubic inch; and, as the space it occupied amounted to 2.05755 cubic inches, it appears that the silk filled no more than about $\frac{1}{55}$ part of the space in which it was confined, the rest of that space being filled with air.

In the experiment No. 1, when the space between the bulb of the thermometer and the glass globe, in the center of which it was confined, was filled with nothing but air, the time taken up by the thermometer in cool-

ing from 70° to 10° was 576 seconds; but in the experiment No. 4, when this same space was filled with 54 parts air, and 1 part raw silk, the time of cooling was 1284 seconds.

Now, supposing that the silk had been totally incapable of conducting any Heat at all, if we suppose, at the same time, that it had no power to prevent the air remaining in the globe from conducting it, in that case its presence in the globe could only have prolonged the time of cooling in proportion to the quantity of the air it had displaced to the quantity remaining, that is to say, as 1 is to 54, or a little more than 10 seconds. But the time of cooling was actually prolonged 708 seconds (for in the experiment No. 1 it was 576 seconds, and in the experiment No. 4 it was 1284 seconds, as has just been observed); and this shows that the silk not only did not conduct the Heat itself, but that it prevented the air by which its interstices were filled from conducting it; or, at least, it greatly weakened its power of conducting it.

The next question which arises is, how air can be prevented from conducting Heat? and this necessarily involves another, which is, How does air conduct Heat?

If air conducted Heat, as it is probable that the metals and water, and all other solid bodies and unelastic fluids, conduct it, — that is to say, if, its particles remaining in their places, the Heat passed from one particle to another, through the whole mass, as there is no reason to suppose that the propagation of Heat is necessarily in right lines, I cannot conceive how the interposition of so small a quantity of any solid body as $\frac{1}{55}$ part of the volume of the air could have effected so remarkable a diminution of the conducting power of the air, as ap-

peared in the experiment (No. 4) with raw silk, above-mentioned.

If air and water conducted Heat in the same *manner*, it is more than probable that their conducting powers might be impaired by the same means; but when I made the experiment with water, by filling the glass globe, in the center of which the bulb of the thermometer was suspended, with that fluid, and afterwards varied the experiment by adding 16 grains of raw silk to the water, I did not find that the conducting power of the water was sensibly impaired by the presence of the silk.*

But we have just seen that the same silk, mixed with an equal volume of air, diminished its conducting power in a very remarkable degree; consequently, there is great reason to conclude that water and air conduct Heat in a *different manner*.

But the following experiment, I think, puts the matter beyond all doubt.

It is well known that the power which air possesses of holding water in solution is augmented by Heat, and diminished by cold, and that, if hot air is saturated with water, and if this air is afterwards cooled, a part of its water is necessarily deposited.

I took a cylindrical bottle of very clear transparent glass, about 8 inches in diameter, and 12 inches high, with a short and narrow neck, and, suspending a small piece of linen rag, moderately wet, in the middle of it, I plunged it into a large vessel of water, warmed to about 100° of Fahrenheit's thermometer, where I suf-

* The experiment here mentioned was made in the year 1787; but the result of a more careful investigation of the subject has since shown that Heat is not propagated in water in the manner here supposed. (See Essay VII, Edition of 1798.)

ferred it to remain till the contained air was not only warm, but thoroughly saturated with the moisture which it attracted from the linen rag, the mouth of the bottle being well stopped up during this time with a good cork; this being done, I removed the cork for a moment, to take away the linen rag, and, stopping up the bottle again immediately, I took it out of the warm water, and plunged it into a large cylindrical jar, about 12 inches in diameter, and 16 inches high, containing just so much ice-cold water, that, when the bottle was plunged into it, and quite covered by it, the jar was quite full.

As the jar was of very fine transparent glass, as well as the bottle, and as the cold water contained in the jar was perfectly clear, I could see what passed in the bottle most distinctly; and having taken care to place the jar upon a table near the window, in a very favourable light, I set myself to observe the appearances which should take place, with all that anxious expectation which a conviction that the result of the experiment must be decisive naturally inspired.

I was certain that the air contained in the bottle could not part with its Heat, without at the same time—that is to say, *at the same moment, and in the same place*—parting with a portion of its water; if, therefore, the Heat penetrated the mass of air from the center to the surface, or *passed through it* from particle to particle, in the same manner as it is probable that it passes through water, and all other unelastic fluids,* by far the greater part of the air contained in the bottle would part with its Heat,

* This opinion respecting the manner in which Heat is propagated in water, and other unelastic fluids, was afterwards found to be erroneous, as has been shown in the preceding Essay.

when *not actually in contact with the glass*, and a proportional part of its water being let fall at the same time, and in the *same place*, would necessarily descend in the form of rain; and, though this rain might be too fine to be visible in its descent, yet I was sure I should find it at the bottom of the bottle, if not in visible drops of water, yet in that kind of cloudy covering which cold glass acquires from a contact with hot steam or watery vapour.

But if the particles of air, instead of communicating their Heat from one to another, from the center to the surface of the bottle, each in its turn, and for itself, came to the surface of the bottle, and there deposited its Heat and its water, I concluded that the cloudiness occasioned by this deposit of water would appear all over the bottle, or, at least, not more of it at the bottom than at the sides, but rather less; and this I found to be the case in fact.

The cloudiness first made its appearance upon the sides of the bottle, near the top of it; and from thence it gradually spread itself downwards, till, growing fainter as it descended lower, it was hardly visible at the distance of half an inch from the bottom of the bottle; and upon the bottom itself, which was nearly flat, there was scarcely the smallest appearance of cloudiness.

These appearances, I think, are easy to be accounted for. The air immediately in contact with the glass being cooled, and having deposited a part of its water upon the surface of the glass, at the same time that it communicates to it its Heat, slides downwards by the sides of the bottle in consequence of its increased specific gravity, and, taking its place at the bottom of the bottle, forces the whole mass of hot air upwards; which, in its

turn, coming to the sides of the bottle, *there* deposits its Heat and its water, and afterwards bending its course downwards, this circulation is continued till all the air in the bottle has acquired the exact temperature of the water in the jar.

From hence it is clear why the first appearance of condensed vapour is near the top of the bottle, as also why the greatest collection of vapour is in that part, and that so very small a quantity of it is found nearer the bottom of the bottle.

This experiment confirmed me in an opinion which I had for some time entertained, that, though the particles of air individually, or each for itself, are capable of receiving and *transporting* Heat, yet air in a quiescent state, or as a fluid whose parts are at rest with respect to each other, is not capable of conducting it, or giving it a passage; in short, that Heat is incapable of *passing through a mass of air*, penetrating from one particle of it to another, and that it is to this circumstance that its non-conducting power is principally owing.

It is also to this circumstance, in a great measure, that it is owing that its non-conducting power, or its apparent warmth when employed as a covering for confining Heat, is so remarkably increased upon its being mixed with a small quantity of any very fine, light, solid substance, such as the raw silk, fur, eider-down, &c., in the foregoing experiments; for as I have already observed, though these substances, in the very small quantities in which they were made use of, could hardly have prevented, in any considerable degree, the air from conducting or giving a *passage* to the Heat, had it been capable of passing through it, yet they might very much impede it in the operation of transporting it.

But there is another circumstance which it is necessary to take into the account, and that is the attraction which subsists between air and the bodies above mentioned, and other like substances, constituting natural and artificial cloathing. For, though the incapacity of air to give a passage to Heat in the manner solid bodies permit it to pass through them may enable us to account for its warmth under certain circumstances, yet the bare admission of this principle does not seem to be sufficient to account for the very extraordinary degrees of warmth which we find in furs and in feathers, and in various other kinds of natural and artificial cloathing; nor even that which we find in snow; for if we suppose the particles of air to be at liberty to *carry off* the Heat which these bodies are meant to confine, without any other obstruction or hindrance than that arising from their *vis inertiae*, or the force necessary to put them in motion, it seems probable that the succession of fresh particles of cold air, and the consequent loss of Heat, would be much more rapid than we find it to be in fact.

That an attraction, and a very strong one, actually subsists between the particles of air and the fine hair or furs of beasts, the feathers of birds, wool, &c., appears by the obstinacy with which these substances retain the air which adheres to them, even when immersed in water, and put under the receiver of an air-pump; and that this attraction is essential to the warmth of these bodies, I think is very easy to be demonstrated.

In furs, for instance, the attraction between the particles of air and the fine hairs in which it is concealed being greater than the increased elasticity or repulsion of those particles with regard to each other, arising from

the Heat communicated to them by the animal body, the air in the fur, though heated, is not easily displaced; and this coat of confined air is the real barrier which defends the animal body from the external cold. This air cannot *carry off* the Heat of the animal, because it is itself confined, by its attraction to the hair or fur; and it transmits it with great difficulty, if it transmits at all, as has been abundantly shown by the foregoing experiments.

Hence it appears why those furs which are the finest, longest, and thickest, are likewise the warmest; and how the furs of the beaver, of the otter, and of other like quadrupeds which live much in water, and the feathers of water-fowls, are able to confine the Heat of those animals in winter, notwithstanding the extreme coldness and great conducting power of the water in which they swim. The attraction between these substances and the air which occupies their interstices is so great that this air is not dislodged even by the contact of water, but, remaining in its place, it defends the body of the animal at the same time from being wet, and from being robbed of its Heat by the surrounding cold fluid, and it is possible that the pressure of this fluid upon the covering of air confined in the interstices of the fur, or feathers, may at the same time increase its warmth, or non-conducting power, in such a manner that the animal may not, in fact, lose more heat when in water than when in air: for we have seen, by the foregoing experiments, that, under certain circumstances, the warmth of a covering is increased by bringing its component parts nearer together, or by increasing its density even at the expense of its thickness. But this point will be further investigated hereafter.

Bears, wolves, foxes, hares, and other like quadrupeds, inhabitants of cold countries, which do not often take the water, have their fur much thicker upon their backs than upon their bellies. The heated air occupying the interstices of the hairs of the animal tending naturally to rise upwards, in consequence of its increased elasticity, would escape with much greater ease from the backs of quadrupeds than from their bellies, had not Providence wisely guarded against this evil by increasing the obstructions in those parts, which entangle it and confine it to the body of the animal. And this, I think, amounts almost to a proof of the principles assumed relative to the manner in which Heat is carried off by air, and the causes of the non-conducting power of air, or its apparent warmth, when, being combined with other bodies, it acts as a covering for confining Heat.

The snows which cover the surface of the earth in winter, in high latitudes, are doubtless designed by an all-provident Creator as a garment to defend it against the piercing winds from the polar regions, which prevail during the cold season.

These winds, notwithstanding the vast tracts of continent over which they blow, retain their sharpness as long as the ground they pass over is covered with snow; and it is not till, meeting with the ocean, they acquire, from a contact with its waters, the Heat which the snows prevent their acquiring from the earth, that the edge of their coldness is taken off, and they gradually die away and are lost.

The winds are always found to be much colder when the ground is covered with snow than when it is bare, and this extraordinary coldness is vulgarly supposed to be communicated to the air by the snow; but this is an

erroneous opinion, for these winds are in general much colder than the snow itself.

They retain their coldness because the snow prevents them from being warmed at the expence of the earth ; and this is a striking proof of the use of the snows in preserving the Heat of the earth during the winter in cold latitudes.

It is remarkable that these winds seldom blow from the poles directly towards the equator, but from the land towards the sea. Upon the eastern coast of North America the cold winds come from the northwest ; but upon the western coast of Europe they blow from the northeast.

That they should blow towards those parts where they can most easily acquire the Heat they are in search of, is not extraordinary ; and that they should gradually cease and die away, upon being warmed by a contact with the waters of the ocean, is likewise agreeable to the nature and causes of their motion ; and if I might be allowed a conjecture respecting the principal use of the seas, or the reason why the proportion of water upon the surface of our globe is so great, compared to that of the land, it is to maintain a more equal temperature in the different climates, by heating or cooling the winds which at certain periods blow from the great continents.

That cold winds actually grow much milder upon passing over the sea, and that hot winds are refreshed by a contact with its waters, is very certain ; and it is equally certain that the winds from the ocean are, in all climates, much more temperate than those which blow from the land.

In the islands of Great Britain and Ireland, there is not the least doubt but the great mildness of the climate

is entirely owing to their separation from the neighbouring continent by so large a tract of sea; and in all similar situations, in every part of the globe, similar causes are found to produce similar effects.

The cold northwest winds which prevail upon the coast of North America during the winter seldom extend above 100 leagues from the shore, and they are always found to be less violent, and less piercing, as they are further from the land.

These periodical winds from the continents of Europe and North America prevail most towards the end of the month of February, and in the month of March; and I conceive that they contribute very essentially towards bringing on an early spring, and a fruitful summer, particularly when they are very violent in the month of March, and if at that time the ground is well covered with snow. The whole atmosphere of the polar regions being, as it were, transported into the ocean by these winds, is there warmed and saturated with water: and, a great accumulation of air upon the sea being the necessary consequence of the long continuance of these cold winds from the shore, upon their ceasing the warm breezes from the sea necessarily commence, and, spreading themselves upon the land far and wide, assist the returning sun in dismantling the earth of the remains of her winter garment, and in bringing forward into life all the manifold beauties of the new-born year.

This warmed air which comes in from the sea, having acquired its Heat from a contact with the ocean, is, of course, saturated with water; and hence the warm showers of April and May, so necessary to a fruitful season.

The ocean may be considered as the great reservoir

and equalizer of Heat ; and its benign influences in preserving a proper temperature in the atmosphere operate in all seasons and in all climates.

The parching winds from the land under the torrid zone are cooled by a contact with its waters, and, in return, the breezes from the sea, which at certain hours of the day come in to the shores in almost all hot countries, bring with them refreshment, and, as it were, new life and vigor both to the animal and vegetable creation, fainting and melting under the excessive Heats of a burning sun. What a vast tract of country, now the most fertile upon the face of the globe, would be absolutely barren and uninhabitable on account of the excessive Heat, were it not for these refreshing sea-breezes ! And is it not more than probable, that the extremes of heat and of cold in the different seasons in the temperate and frigid zones would be quite intolerable, were it not for the influence of the ocean in preserving an equability of temperature ?

And to these purposes the ocean is wonderfully well adapted, not only on account of the great power of water to absorb Heat, and the vast depth and extent of the different seas (which are such that one summer or one winter could hardly be supposed to have any sensible effect in heating or cooling this enormous mass) ; but also on account of the continual circulation which is carried on in the ocean itself by means of the currents which prevail in it. The waters under the torrid zone being carried by these currents towards the polar regions, are there cooled by a contact with the cold winds, and, having thus communicated their Heat to these inhospitable regions, return towards the equator, carrying with them refreshment for those parching climates.

The wisdom and goodness of Providence have often been called in question with regard to the distribution of land and water upon the surface of our globe, the vast extent of the ocean having been considered as a proof of the little regard that has been paid to man in this distribution. But the more light we acquire respecting the real constitution of things, and the various uses of the different parts of the visible creation, the less we shall be disposed to indulge ourselves in such frivolous criticisms.

AN
EXPERIMENTAL INQUIRY
CONCERNING THE
SOURCE OF THE HEAT WHICH IS
EXCITED BY FRICTION.

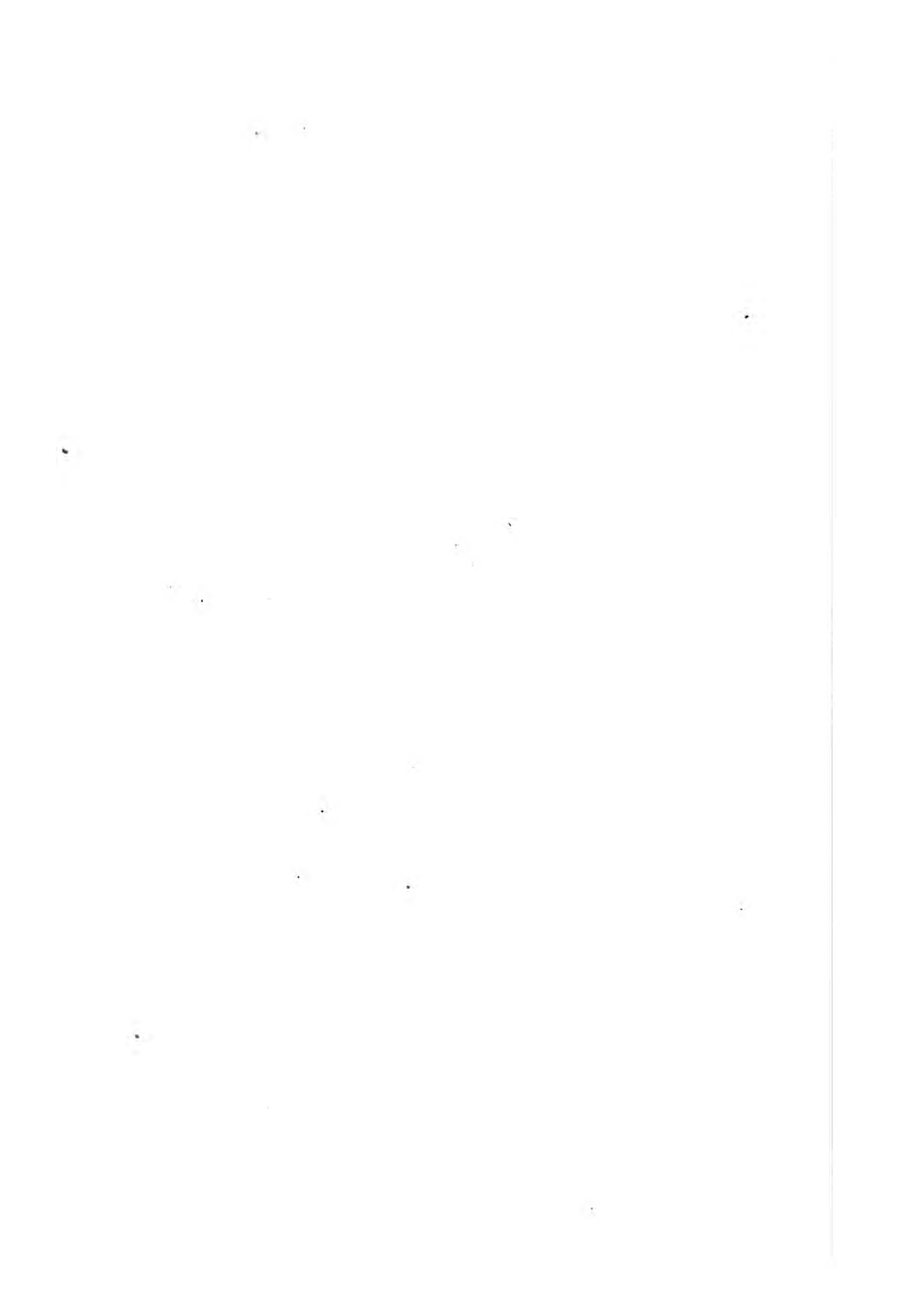

AN INQUIRY

CONCERNING THE

SOURCE OF THE HEAT WHICH IS EXCITED BY
FRICTION.

IT frequently happens that in the ordinary affairs and occupations of life, opportunities present themselves of contemplating some of the most curious operations of Nature; and very interesting philosophical experiments might often be made, almost without trouble or expence, by means of machinery contrived for the mere mechanical purposes of the arts and manufactures.

I have frequently had occasion to make this observation; and am persuaded that a habit of keeping the eyes open to everything that is going on in the ordinary course of the business of life has oftener led, as it were by accident, or in the playful excursions of the imagination, put into action by contemplating the most common appearances, to useful doubts and sensible schemes for investigation and improvement, than all the more intense meditations of philosophers in the hours expressly set apart for study.

It was by accident that I was led to make the experiments of which I am about to give an account; and, though they are not perhaps of sufficient importance to merit so formal an introduction, I cannot help flattering myself that they will be thought curious in several re-

spects, and worthy of the honour of being made known to the Royal Society.

Being engaged lately in superintending the boring of cannon in the workshops of the military arsenal at Munich, I was struck with the very considerable degree of Heat which a brass gun acquires in a short time in being bored, and with the still more intense Heat (much greater than that of boiling water, as I found by experiment) of the metallic chips separated from it by the borer.

The more I meditated on these phænomena, the more they appeared to me to be curious and interesting. A thorough investigation of them seemed even to bid fair to give a farther insight into the hidden nature of Heat; and to enable us to form some reasonable conjectures respecting the existence, or non-existence, of an *igneous fluid*, — a subject on which the opinions of philosophers have in all ages been much divided.

In order that the Society may have clear and distinct ideas of the speculations and reasonings to which these appearances gave rise in my mind, and also of the specific objects of philosophical investigation they suggested to me, I must beg leave to state them at some length, and in such manner as I shall think best suited to answer this purpose.

From *whence comes* the Heat actually produced in the mechanical operation above mentioned?

Is it furnished by the metallic chips which are separated by the borer from the solid mass of metal?

If this were the case, then, according to the modern doctrines of latent Heat, and of caloric, the *capacity for Heat* of the parts of the metal, so reduced to chips, ought not only to be changed, but the change undergone

by them should be sufficiently great to account for *all* the Heat produced.

But no such change had taken place; for I found, upon taking equal quantities, by weight, of these chips, and of thin slips of the same block of metal separated by means of a fine saw, and putting them at the same temperature (that of boiling water) into equal quantities of cold water (that is to say, at the temperature of $59\frac{1}{2}^{\circ}$ F.), the portion of water into which the chips were put was not, to all appearance, heated either less or more than the other portion in which the slips of metal were put.

This experiment being repeated several times, the results were always so nearly the same that I could not determine whether any, or what change had been produced in the metal, *in regard to its capacity for Heat*, by being reduced to chips by the borer.*

From hence it is evident that the Heat produced could not possibly have been furnished at the expence of the

* As these experiments are important, it may perhaps be agreeable to the Society to be made acquainted with them in their details.

One of them was as follows:—

To 4590 grains of water, at the temperature of $59\frac{1}{2}^{\circ}$ F. (an allowance as compensation, reckoned in water, for the capacity for Heat of the containing cylindrical tin vessel being included), were added 1016 $\frac{1}{8}$ grains of gun-metal in thin slips, separated from the gun by means of a fine saw, being at the temperature of 210° F. When they had remained together 1 minute, and had been well stirred about, by means of a small rod of light wood, the Heat of the mixture was found to be = 63° .

From this experiment the *specific Heat* of the metal, calculated according to the rule given by Dr. Crawford, turns out to be = 0.1100, that of water being = 1.0000.

An experiment was afterwards made with the metallic chips as follows:—

To the same quantity of water as was used in the experiment above mentioned, at the same temperature (*viz.* $59\frac{1}{2}^{\circ}$), and in the same cylindrical tin vessel, were now put 1016 $\frac{1}{8}$ grains of metallic chips of gun-metal bored out of the same gun from which the slips used in the foregoing experiment were taken, and at the same temperature (210°). The Heat of the mixture at the end of 1 minute was just 63° , as before; consequently the *specific Heat* of these metallic chips was = 0.1100. Each of the above experiments was repeated three times, and always with nearly the same results.

latent Heat of the metallic chips. But, not being willing to rest satisfied with these trials, however conclusive they appeared to me to be, I had recourse to the following still more decisive experiment.

Taking a cannon (a brass six-pounder), cast solid, and rough as it came from the foundry (see Fig. 1, Tab. IV.), and fixing it (horizontally) in the machine used for boring, and at the same time finishing the outside of the cannon by turning (see Fig. 2), I caused its extremity to be cut off, and, by turning down the metal in that part, a solid cylinder was formed, $7\frac{3}{4}$ inches in diameter, and $9\frac{8}{10}$ inches long, which, when finished, remained joined to the rest of the metal (that which, properly speaking, constituted the cannon) by a small cylindrical neck, only $2\frac{1}{5}$ inches in diameter, and $3\frac{8}{10}$ inches long.

This short cylinder, which was supported in its horizontal position and turned round its axis by means of the neck by which it remained united to the cannon, was now bored with the horizontal borer used in boring cannon; but its bore, which was 3.7 inches in diameter, instead of being continued through its whole length (9.8 inches) was only 7.2 inches in length; so that a solid bottom was left to this hollow cylinder, which bottom was 2.6 inches in thickness.

This cavity is represented by dotted lines in Fig. 2; as also in Fig. 3, where the cylinder is represented on an enlarged scale.

This cylinder being designed for the express purpose of generating Heat *by friction*, by having a blunt borer forced against its solid bottom at the same time that it should be turned round its axis by the force of horses, in order that the Heat accumulated in the cylinder might

from time to time be measured, a small round hole (see *d, e*, Fig. 3), 0.37 of an inch only in diameter, and 4.2 inches in depth, for the purpose of introducing a small cylindrical mercurial thermometer, was made in it, on one side, in a direction perpendicular to the axis of the cylinder, and ending in the middle of the solid part of the metal which formed the bottom of its bore.

The solid contents of this hollow cylinder, exclusive of the cylindrical neck by which it remained united to the cannon, were $385\frac{3}{4}$ cubic inches, English measure, and it weighed 113.13 lb., avoirdupois; as I found on weighing it at the end of the course of experiments made with it, and after it had been separated from the cannon with which, during the experiments, it remained connected.*

Experiment No. 1.

This experiment was made in order to ascertain how much Heat was actually generated by friction, when a blunt steel borer being so forcibly shoved (by means of a strong screw) against the bottom of the bore of the cylinder, that the pressure against it was equal to the weight of about 10,000 lb., avoirdupois, the cylinder

* For fear I should be suspected of prodigality in the prosecution of my philosophical researches, I think it necessary to inform the Society that the cannon I made use of in this experiment was not sacrificed to it. The short hollow cylinder which was formed at the end of it was turned out of a cylindrical mass of metal, about 2 feet in length, projecting beyond the muzzle of the gun, called in the German language the *verlorner kopf* (the head of the cannon to be thrown away), and which is represented in Fig. 1.

This original projection, which is cut off before the gun is bored, is always cast with it, in order that, by means of the pressure of its weight on the metal in the lower part of the mould during the time it is cooling, the gun may be the more compact in the neighbourhood of the muzzle, where, without this precaution, the metal would be apt to be porous, or full of honeycombs.

was turned round on its axis (by the force of horses) at the rate of about 32 times in a minute.

This machinery, as it was put together for the experiment, is represented by Fig. 2. W is a strong horizontal iron bar, connected with proper machinery carried round by horses, by means of which the cannon was made to turn round its axis.

To prevent, as far as possible, the loss of any part of the Heat that was generated in the experiment, the cylinder was well covered up with a fit coating of thick and warm flannel, which was carefully wrapped round it, and defended it on every side from the cold air of the atmosphere. This covering is not represented in the drawing of the apparatus, Fig. 2.

I ought to mention that the borer was a flat piece of hardened steel, 0.63 of an inch thick, 4 inches long, and nearly as wide as the cavity of the bore of the cylinder, namely, $3\frac{1}{2}$ inches. Its corners were rounded off at its end, so as to make it fit the hollow bottom of the bore; and it was firmly fastened to the iron bar (*m*) which kept it in its place. The area of the surface by which its end was in contact with the bottom of the bore of the cylinder was nearly $2\frac{1}{3}$ inches. This borer, which is distinguished by the letter *n*, is represented in most of the figures.

At the beginning of the experiment, the temperature of the air in the shade, as also that of the cylinder, was just 60° F.

At the end of 30 minutes, when the cylinder had made 960 revolutions about its axis, the horses being stopped, a cylindrical mercurial thermometer, whose bulb was $\frac{3.2}{100}$ of an inch in diameter, and $3\frac{1}{4}$ inches in length, was introduced into the hole made to receive it, in the

side of the cylinder, when the mercury rose almost instantly to 130°.

Though the Heat could not be supposed to be quite equally distributed in every part of the cylinder, yet, as the length of the bulb of the thermometer was such that it extended from the axis of the cylinder to near its surface, the Heat indicated by it could not be very different from that of the *mean temperature* of the cylinder; and it was on this account that a thermometer of that particular form was chosen for this experiment.

To see how fast the Heat escaped out of the cylinder (in order to be able to make a probable conjecture respecting the quantity given off by it during the time the Heat generated by the friction was accumulating), the machinery standing still, I suffered the thermometer to remain in its place near three quarters of an hour, observing and noting down, at small intervals of time, the height of the temperature indicated by it.

	The Heat, as shown by the thermometer, was
Thus at the end of 4 minutes	126°
after 5 minutes, always reckoning from the first observation	125
at the end of 7 minutes	123
12 "	120
14 "	119
16 "	118
20 "	116
24 "	115
28 "	114
31 "	113
34 "	112
37½ "	111
and when 41 minutes had elapsed	110

Having taken away the borer, I now removed the

metallic dust, or, rather, scaly matter, which had been detached from the bottom of the cylinder by the blunt steel borer, in this experiment; and, having carefully weighed it, I found its weight to be 837 grains, Troy.

Is it possible that the very considerable quantity of Heat that was produced in this experiment (a quantity which actually raised the temperature of above 113 lb. of gun-metal at least 70 degrees of Fahrenheit's thermometer, and which, of course, would have been capable of melting $6\frac{1}{2}$ lb. of ice, or of causing near 5 lb. of ice-cold water to boil) could have been furnished by so inconsiderable a quantity of metallic dust? and this merely in consequence of *a change* of its capacity for Heat?

As the weight of this dust (837 grains, Troy) amounted to no more than $\frac{1}{848}$ th part of that of the cylinder, it must have lost no less than 948 degrees of Heat, to have been able to have raised the temperature of the cylinder 1 degree; and consequently it must have given off 66,360 degrees of Heat to have produced the effects which were actually found to have been produced in the experiment!

But without insisting on the improbability of this supposition, we have only to recollect, that from the results of actual and decisive experiments, made for the express purpose of ascertaining that fact, the capacity for Heat of the metal of which great guns are cast *is not sensibly changed* by being reduced to the form of metallic chips in the operation of boring cannon; and there does not seem to be any reason to think that it can be much changed, if it be changed at all, in being reduced to much smaller pieces by means of a borer that is less sharp.

If the Heat, or any considerable part of it, were pro-

duced in consequence of a change in the capacity for Heat of a part of the metal of the cylinder, as such change could only be *superficial*, the cylinder would by degrees be *exhausted*; or the quantities of Heat produced in any given short space of time would be found to diminish gradually in successive experiments. To find out if this really happened or not, I repeated the last-mentioned experiment several times with the utmost care; but I did not discover the smallest sign of exhaustion in the metal, notwithstanding the large quantities of Heat actually given off.

Finding so much reason to conclude that the Heat generated in these experiments, or *excited*, as I would rather choose to express it, was not furnished *at the expense of the latent Heat or combined caloric* of the metal, I pushed my inquiries a step farther, and endeavoured to find out whether the air did, or did not, contribute anything in the generation of it.

Experiment No. 2.

As the bore of the cylinder was cylindrical, and as the iron bar (*m*), to the end of which the blunt steel borer was fixed, was square, the air had free access to the inside of the bore, and even to the bottom of it, where the friction took place by which the Heat was excited.

As neither the metallic chips produced in the ordinary course of the operation of boring brass cannon, nor the finer scaly particles produced in the last-mentioned experiments by the friction of the blunt borer, showed any signs of calcination, I did not see how the air could possibly have been the cause of the Heat that was produced; but, in an investigation of this kind, I thought that no pains should be spared to clear away the rubbish, and

leave the subject as naked and open to inspection as possible.

In order, by one decisive experiment, to determine whether the air of the atmosphere had any part, or not, in the generation of the Heat, I contrived to repeat the experiment under circumstances in which *it was evidently impossible for it to produce any effect whatever*. By means of a piston exactly fitted to the mouth of the bore of the cylinder, through the middle of which piston the square iron bar, to the end of which the blunt steel borer was fixed, passed in a square hole made perfectly air-tight, the access of the external air to the inside of the bore of the cylinder was effectually prevented. (In Fig. 3, this piston (*p*) is seen in its place; it is likewise shown in Fig. 7 and 8.)

I did not find, however, by this experiment, that the exclusion of the air diminished, in the smallest degree, the quantity of Heat excited by the friction.

There still remained one doubt, which, though it appeared to me to be so slight as hardly to deserve any attention, I was however desirous to remove. The piston which closed the mouth of the bore of the cylinder, in order that it might be air-tight, was fitted into it with so much nicety, by means of its collars of leather, and pressed against it with so much force, that, notwithstanding its being oiled, it occasioned a considerable degree of friction when the hollow cylinder was turned round its axis. Was not the Heat produced, or at least some part of it, occasioned by this friction of the piston? and, as the external air had free access to the extremity of the bore, where it came in contact with the piston, is it not possible that this air may have had some share in the generation of the Heat produced?

Experiment No. 3.

A quadrangular oblong deal box (see Fig. 4), water-tight, $11\frac{1}{2}$ English inches long, $9\frac{4}{10}$ inches wide, and $9\frac{6}{10}$ inches deep (measured in the clear), being provided with holes or slits in the middle of each of its ends, just large enough to receive, the one the square iron rod to the end of which the blunt steel borer was fastened, the other the small cylindrical neck which joined the hollow cylinder to the cannon; when this box (which was occasionally closed above by a wooden cover or lid moving on hinges) was put into its place, that is to say, when, by means of the two vertical openings or slits in its two ends (the upper parts of which openings were occasionally closed by means of narrow pieces of wood sliding in vertical grooves), the box (*g, h, i, k*, Fig. 3) was fixed to the machinery in such a manner that its bottom (*i, k*) being in the plane of the horizon, its axis coincided with the axis of the hollow metallic cylinder; it is evident, from the description, that the hollow metallic cylinder would occupy the middle of the box, without touching it on either side (as it is represented in Fig. 3); and that, on pouring water into the box, and filling it to the brim, the cylinder would be completely covered and surrounded on every side by that fluid. And farther, as the box was held fast by the strong square iron rod (*m*) which passed in a *square hole* in the center of one of its ends (*a*, Fig. 4), while the round or cylindrical neck, which joined the hollow cylinder to the end of the cannon, could turn round freely on its axis in the *round hole* in the center of the other end of it, it is evident that the machinery could be put in motion without the least danger of forcing the box out of its place, throwing

the water out of it, or deranging any part of the apparatus.

Everything being ready, I proceeded to make the experiment I had projected in the following manner.

The hollow cylinder having been previously cleaned out, and the inside of its bore wiped with a clean towel till it was quite dry, the square iron bar, with the blunt steel borer fixed to the end of it, was put into its place; the mouth of the bore of the cylinder being closed at the same time by means of the circular piston, through the center of which the iron bar passed.

This being done, the box was put in its place, and the joinings of the iron rod and of the neck of the cylinder with the two ends of the box having been made water-tight by means of collars of oiled leather, the box was filled with cold water (*viz.* at the temperature of 60°), and the machine was put in motion.

The result of this beautiful experiment was very striking, and the pleasure it afforded me amply repaid me for all the trouble I had had in contriving and arranging the complicated machinery used in making it.

The cylinder, revolving at the rate of about 32 times in a minute, had been in motion but a short time, when I perceived, by putting my hand into the water and touching the outside of the cylinder, that Heat was generated; and it was not long before the water which surrounded the cylinder began to be sensibly warm.

At the end of 1 hour I found, by plunging a thermometer into the water in the box (the quantity of which fluid amounted to 18.77 lb., avoirdupois, or $2\frac{1}{4}$ wine gallons), that its temperature had been raised no less than 47 degrees; being now 107° of Fahrenheit's scale.

When 30 minutes more had elapsed, or 1 hour and 30 minutes after the machinery had been put in motion, the Heat of the water in the box was 142° .

At the end of 2 hours, reckoning from the beginning of the experiment, the temperature of the water was found to be raised to 178° .

At 2 hours 20 minutes it was at 200° ; and at 2 hours 30 minutes it ACTUALLY BOILED!

It would be difficult to describe the surprise and astonishment expressed in the countenances of the bystanders, on seeing so large a quantity of cold water heated, and actually made to boil, without any fire.

Though there was, in fact, nothing that could justly be considered as surprising in this event, yet I acknowledge fairly that it afforded me a degree of childish pleasure, which, were I ambitious of the reputation of a *grave philosopher*, I ought most certainly rather to hide than to discover.

The quantity of Heat excited and accumulated in this experiment was very considerable; for, not only the water in the box, but also the box itself (which weighed $15\frac{1}{4}$ lb.), and the hollow metallic cylinder, and that part of the iron bar which, being situated within the cavity of the box, was immersed in the water, were heated 150 degrees of Fahrenheit's scale; *viz.* from 60° (which was the temperature of the water and of the machinery at the beginning of the experiment) to 210° , the Heat of boiling water at Munich.

The total quantity of Heat generated may be estimated with some considerable degree of precision as follows:—

Of the Heat excited there appears to have been actually accumulated, —

Quantity of ice-cold water which, with the given quantity of Heat, might have been heated 180 degrees, or made to boil.
In avoirdupois weight.

In the water contained in the wooden box, 18 $\frac{3}{4}$ lb., avoirdupois, heated 150 degrees, namely, from 60° to 210° F. lb. 15.2

In 113.13 lb. of gun-metal (the hollow cylinder), heated 150 degrees; and, as the capacity for Heat of this metal is to that of water as 0.1100 to 1.0000, this quantity of Heat would have heated 12 $\frac{1}{2}$ lb. of water the same number of degrees 10.37

In 36.75 cubic inches of iron (being that part of the iron bar to which the borer was fixed which entered the box), heated 150 degrees; which may be reckoned equal in capacity for Heat to 1.21 lb. of water 1.01

N. B. No estimate is here made of the Heat accumulated in the wooden box, nor of that dispersed during the experiment.

Total quantity of ice-cold water which, with the Heat actually generated by friction, and accumulated in 2 hours and 30 minutes, might have been heated 180 degrees, or made to boil 26.58

From the knowledge of the *quantity* of Heat actually produced in the foregoing experiment, and of the *time* in which it was generated, we are enabled to ascertain *the velocity of its production*, and to determine how large a fire must have been, or how much fuel must have been consumed, in order that, in burning equably, it should have produced by combustion the same quantity of Heat in the same time.

In one of Dr. Crawford's experiments (see his Treatise on Heat, p. 321), 37 lb. 7 oz., Troy, = 181,920 grains of water, were heated 2 $\frac{1}{10}$ degrees of Fahrenheit's thermometer with the Heat generated in the combustion of 26 grains of wax. This gives 382,032 grains of water heated 1 degree with 26 grains of wax, or 14,693 $\frac{1}{2}$ $\frac{4}{8}$ grains of water heated 1 degree, or $\frac{14693.8}{180} = 81.631$

grains heated 180 degrees, with the Heat generated in the combustion of 1 grain of wax.

The quantity of ice-cold water which might have been heated 180 degrees with the Heat generated by friction in the before-mentioned experiment was found to be 26.58 lb., avoirdupois, = 188,060 grains; and, as 81.631 grains of ice-cold water require the Heat generated in the combustion of 1 grain of wax to heat it 180 degrees, the former quantity of ice-cold water, namely, 188,060 grains, would require the combustion of no less than 2303.8 grains (= $4\frac{8}{10}$ oz., Troy) of wax to heat it 180 degrees.

As the experiment (No. 3) in which the given quantity of Heat was generated by friction lasted 2 hours and 30 minutes, = 150 minutes, it is necessary, for the purpose of ascertaining how many wax candles of any given size must burn together, in order that in the combustion of them the given quantity of Heat may be generated in the given time, and consequently *with the same celerity* as that with which the Heat was generated by friction in the experiment, that the size of the candles should be determined, and the quantity of wax consumed in a given time by each candle in burning equably should be known.

Now I found, by an experiment made on purpose to finish these computations, that when a good wax candle, of a moderate size, $\frac{3}{4}$ of an inch in diameter, burns with a clear flame, just 49 grains of wax are consumed in 30 minutes. Hence it appears that 245 grains of wax would be consumed by such a candle in 150 minutes; and that, to burn the quantity of wax (= 2303.8 grains) necessary to produce the quantity of Heat actually obtained by friction in the experiment in question, and in

the given time (150 minutes), *nine candles*, burning at once, would not be sufficient; for 9 multiplied into 245 (the number of grains consumed by each candle in 150 minutes) amounts to no more than 2205 grains; whereas the quantity of wax necessary to be burnt, in order to produce the given quantity of Heat, was found to be 2303.8 grains.

From the result of these computations it appears, that the quantity of Heat produced equably, or in a continual stream (if I may use that expression), by the friction of the blunt steel borer against the bottom of the hollow metallic cylinder, in the experiment under consideration, was *greater* than that produced equably in the combustion of *nine wax candles*, each $\frac{3}{4}$ of an inch in diameter, all burning together, or at the same time, with clear bright flames.

As the machinery used in this experiment could easily be carried round by the force of one horse (though, to render the work lighter, two horses were actually employed in doing it), these computations shew further how large a quantity of Heat might be produced, by proper mechanical contrivance, merely by the strength of a horse, without either fire, light, combustion, or chemical decomposition; and, in a case of necessity, the Heat thus produced might be used in cooking victuals.

But no circumstances can be imagined in which this method of procuring Heat would not be disadvantageous; for more Heat might be obtained by using the fodder necessary for the support of a horse as fuel.

As soon as the last-mentioned experiment (No. 3) was finished, the water in the wooden box was let off, and the box removed; and the borer being taken out of the cylinder, the scaly metallic powder which had been pro-

duced by the friction of the borer against the bottom of the cylinder was collected, and, being carefully weighed, was found to weigh 4145 grains, or about $8\frac{2}{3}$ oz., Troy.

As this quantity was produced in $2\frac{1}{2}$ hours, this gives 824 grains for the quantity produced *in half an hour*.

In the first experiment, which lasted only *half an hour*, the quantity produced was 837 grains.

In the experiment No. 1, the quantity of Heat generated in *half an hour* was found to be equal to that which would be required to heat 5 lb., avoirdupois, of ice-cold water 180 degrees, or cause it to boil.

According to the result of the experiment No. 3, the Heat generated in *half an hour* would have caused 5.31 lb. of ice-cold water to boil. But, in this last-mentioned experiment, the Heat generated being more effectually confined, less of it was lost; which accounts for the difference of the results of the two experiments.

It remains for me to give an account of one experiment more, which was made with this apparatus. I found, by the experiment No. 1, how much Heat was generated when the air had free access to the metallic surfaces which were rubbed together. By the experiment No. 2, I found that the quantity of Heat generated was not sensibly diminished when the free access of the air was prevented; and by the result of No. 3, it appeared that the generation of the Heat was not prevented or retarded by keeping the apparatus immersed in water. But as, in this last-mentioned experiment, the water, though it surrounded the hollow metallic cylinder on every side, externally, was not suffered to enter the cavity of its bore (being prevented by the piston), and consequently did not come into contact with the metallic surfaces where the Heat was generated; to see what effects would be

produced by giving the water free access to these surfaces, I now made the

Experiment No. 4.

The piston which closed the end of the bore of the cylinder being removed, the blunt borer and the cylinder were once more put together; and the box being fixed in its place, and filled with water, the machinery was again put in motion.

There was nothing in the result of this experiment that renders it necessary for me to be very particular in my account of it. Heat was generated as in the former experiments, and, to all appearance, quite as rapidly; and I have no doubt but the water in the box would have been brought to boil, had the experiment been continued as long as the last. The only circumstance that surprised me was, to find how little difference was occasioned in the noise made by the borer in rubbing against the bottom of the bore of the cylinder, by filling the bore with water. This noise, which was very grating to the ear, and sometimes almost insupportable, was, as nearly as I could judge of it, quite as loud and as disagreeable when the surfaces rubbed together were wet with water as when they were in contact with air.

By meditating on the results of all these experiments, we are naturally brought to that great question which has so often been the subject of speculation among philosophers; namely, —

What is Heat? Is there any such thing as an *igneous fluid*? Is there anything that can with propriety be called *caloric*?

We have seen that a very considerable quantity of Heat may be excited in the friction of two metallic sur-

faces, and given off in a constant stream or flux *in all directions* without interruption or intermission, and without any signs of diminution or exhaustion.

From whence came the Heat which was continually given off in this manner in the foregoing experiments? Was it furnished by the small particles of metal, detached from the larger solid masses, on their being rubbed together? This, as we have already seen, could not possibly have been the case.

Was it furnished by the air? This could not have been the case; for, in three of the experiments, the machinery being kept immersed in water, the access of the air of the atmosphere was completely prevented.

Was it furnished by the water which surrounded the machinery? That this could not have been the case is evident: *first*, because this water was continually *receiving Heat* from the machinery, and could not at the same time be *giving to*, and *receiving Heat from*, the same body; and, *secondly*, because there was no chemical decomposition of any part of this water. Had any such decomposition taken place (which, indeed, could not reasonably have been expected), one of its component elastic fluids (most probably inflammable air) must at the same time have been set at liberty, and, in making its escape into the atmosphere, would have been detected; but though I frequently examined the water to see if any air-bubbles rose up through it, and had even made preparations for catching them, in order to examine them, if any should appear, I could perceive none; nor was there any sign of decomposition of any kind whatever, or other chemical process, going on in the water.

Is it possible that the Heat could have been supplied by means of the iron bar to the end of which the blunt

steel borer was fixed? or by the small neck of gun-metal by which the hollow cylinder was united to the cannon? These suppositions appear more improbable even than either of those before mentioned; for Heat was continually going off, or *out of the machinery*, by both these passages, during the whole time the experiment lasted.

And, in reasoning on this subject, we must not forget to consider that most remarkable circumstance, that the source of the Heat generated by friction, in these experiments, appeared evidently to be *inexhaustible*.

It is hardly necessary to add, that anything which any *insulated* body, or system of bodies, can continue to furnish *without limitation*, cannot possibly be a *material substance*; and it appears to me to be extremely difficult, if not quite impossible, to form any distinct idea of anything capable of being excited and communicated in the manner the Heat was excited and communicated in these experiments, except it be MOTION.

I am very far from pretending to know how, or by what means or mechanical contrivance, that particular kind of motion in bodies which has been supposed to constitute Heat is excited, continued, and propagated; and I shall not presume to trouble the Society with mere conjectures, particularly on a subject which, during so many thousand years, the most enlightened philosophers have endeavoured, but in vain, to comprehend.

But, although the mechanism of Heat should, in fact, be one of those mysteries of nature which are beyond the reach of human intelligence, this ought by no means to discourage us or even lessen our ardour, in our attempts to investigate the laws of its operations. How far can we advance in any of the paths which science has opened to us before we find ourselves enveloped in

those thick mists which on every side bound the horizon of the human intellect? But how ample and how interesting is the field that is given us to explore!

Nobody, surely, in his sober senses, has ever pretended to understand the mechanism of gravitation; and yet what sublime discoveries was our immortal Newton enabled to make, merely by the investigation of the laws of its action!

The effects produced in the world by the agency of Heat are probably *just as extensive*, and quite as important, as those which are owing to the tendency of the particles of matter towards each other; and there is no doubt but its operations are, in all cases, determined by laws equally immutable.

Before I finish this Essay, I would beg leave to observe, that although, in treating the subject I have endeavoured to investigate, I have made no mention of the names of those who have gone over the same ground before me, nor of the success of their labours, this omission has not been owing to any want of respect for my predecessors, but was merely to avoid prolixity, and to be more at liberty to pursue, without interruption, the natural train of my own ideas.

DESCRIPTION OF THE FIGURES.

FIG. 1 shews the cannon used in the foregoing experiments in the state it was in when it came from the foundry.

Fig. 2 shews the machinery used in the experiments No. 1 and No. 2. The cannon is seen fixed in the machine used for boring cannon. *W* is a strong iron bar (which, to save room in the drawing, is represented as broken off), which bar, being united with machinery (not expressed in the figure) that is carried round by horses, causes the cannon to turn round its axis.

m is a strong iron bar, to the end of which the blunt borer is fixed; which, by being forced against the bottom of the bore of the short hollow cylinder that remains connected by a small cylindrical neck to the end of the cannon, is used in generating Heat by friction.

Fig. 3 shews, on an enlarged scale, the same hollow cylinder that is represented on a smaller scale in the foregoing figure. It is here seen connected with the wooden box (*g, h, i, k*) used in the experiments No. 3 and No. 4, when this hollow cylinder was immersed in water.

p, which is marked by dotted lines, is the piston which closed the end of the bore of the cylinder.

n is the blunt borer seen sidewise.

d, e, is the small hole by which the thermometer was introduced that was used for ascertaining the Heat of the cylinder. To save room in the drawing, the cannon is represented broken off near its muzzle; and the iron

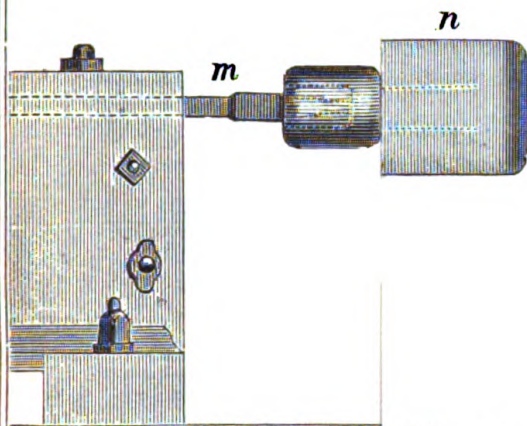
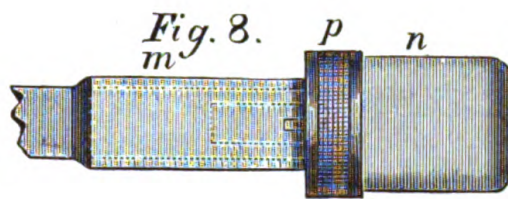
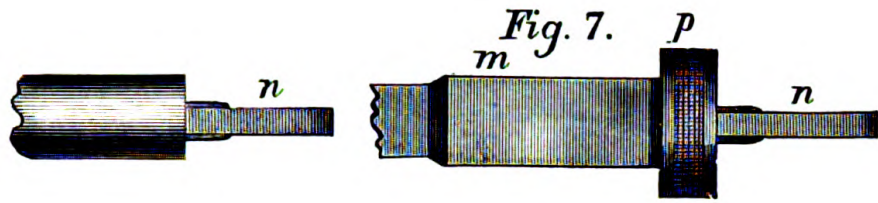

Fig. 4.

