



# Bodleian Libraries

UNIVERSITY OF OXFORD

This book is part of the collection held by the Bodleian Libraries and scanned by Google, Inc. for the Google Books Library Project.

For more information see:

<http://www.bodleian.ox.ac.uk/dbooks>



This work is licensed under a Creative Commons Attribution-NonCommercial-ShareAlike 2.0 UK: England & Wales (CC BY-NC-SA 2.0) licence.

Das  
Römerkastell Saalburg

bei

Homburg v. d. Höhe

VON

L. JACOBI



TAFELN

F  
xiv  
55





302600424L



DAS  
**RÖMERKASTELL SAALBURG**

BEI  
**HOMBURG VOR DER HÖHE**

NACH DEN ERGEBNISSEN DER AUSGRABUNGEN  
UND MIT BENUTZUNG DER HINTERLASSENEN AUFZEICHNUNGEN DES  
KÖNIGL. KONSERVATORS OBERSTEN A. VON COHAUSEN

VON

**L. JACOBI,**  
BAUMEISTER,  
MITGLIED DER REICHS-LIMES-KOMMISSION.

---

KARTE UND TAFELN.



---

**HOMBURG VOR DER HÖHE.**

IM SELBSTVERLAGE DES VERFASSERS.

1897.



Alle Rechte vorbehalten.

## Verzeichnis der Tafeln.

- Karte der Saalburg und Umgegend.
- I. Lage der Saalburg, Plan und Ansicht des Taunus.
  - II. Wachttürme am Pfahlgraben. Profile des Pfahlgrabens.
  - III. Kastell Lochmühle mit Pfahlgraben. Ringwall «Gickelsburg».
  - IV. Kastell Saalburg. Grundriß.
  - V. Dasselbe aus der Vogelperspektive.
  - VI. Grundrisse der Thore. Äußere Ansicht der Porta decumana (Rekonstruktion).
  - VII. Amphitheater, Brunnen und verschiedene Baureste im Kastell.
  - VIII. Hypokausten und Bäder im Kastell.
  - IX. X. Praetorium (Rekonstruktion). Querschnitte der Wallmauern und Gräben.
  - XI. Baracken in der Praetentura (Rekonstruktion).
  - XII. Römischer Legionar mit Pilum, Gladius, Helm und Schild (Modell).
  - XIII. Übersichtsplan des Saalburggebiets.
  - XIV. Hypokaustenbau. Brunnen und Fundstücke aus solchen der Bürgerlichen Niederlassung.
  - XV. Villa vor dem Kastell.
  - XVI. Keller in der Bürgerlichen Niederlassung.
  - XVII. Hypokausten in derselben.
  - XVIII. Bauliche Details. Mauerverbände und Kanalprofile.
  - XIX. » » Ziegel. Heizungsrohren.
  - XX. » » Dachbedeckungen.
  - XXI. » » Profilierte Steine.
  - XXII. Lageplan der Gräber. Gräberhaus.
  - XXIII. Gräber. Grundrisse und Querschnitte.
  - XXIV. Denksteine und Altäre.
  - XXV. u. XXVI. Bildwerke aus Stein.
  - XXVII. Schalen (Mörser) aus Syenit. Mühlsteine aus Basalt und Sandstein. Rekonstruierte Handmühle.
  - XXVIII. Gefäße aus Thon.
  - XXIX. Gefäße aus Terra sigillata.
  - XXX. Ornamente auf Gefäßen aus Terra sigillata.
  - XXXI. Bildliche Darstellungen auf denselben.



Verzeichnis der Tafeln.

- XXXII. Waffen und Geräte aus Stein und Thon.  
XXXIII. Werkzeuge aus Eisen: Äxte, Hämmer etc.  
XXXIV. Werkzeuge aus Eisen: Bohrer, Meißel, Sägeblätter etc.  
XXXV. Geräte und Werkzeuge aus Eisen: Kellen, Scheren, Hacken etc.  
XXXVI. Geräte aus Eisen: Schellen, Schnallen, Roste etc.  
XXXVII. Messer und Hauen aus Eisen.  
XXXVIII. Waffen aus Eisen: Lanzen- und Pfeilspitzen.  
XXXIX. » » » Schwert, Dolche, Pilum, Pfeilspitzen.  
XXXX. Waffenteile und -Beschläge, Katapultspitzen aus Eisen.  
XXXI. Sporen, Hufeisen und Trensen aus Eisen.  
XXXII. Wagenbeschläge aus Eisen.  
XXXIII. Nägel, Klammern, Kloben und Haken aus Eisen.  
XXXIV. Schlüssel aus Eisen und Bronze.  
XXXV. Schloßteile und Thürbeschläge aus Eisen und Bronze.  
XXXVI. Werkzeuge, Geräte, Waffen und Beschläge aus Eisen.  
XXXVII. Eisenblöcke.  
XXXVIII—LI. Gewandnadeln aus Bronze.  
LII. Knöpfe aus Bronze.  
LIII. Doppelknöpfe aus Bronze.  
LIV. Zierscheiben aus Bronze.  
LV. Phalerae und Scheidenbeschläge aus Bronze.  
LVI. Scheidenbeschläge aus Bronze.  
LVII. Henkel und Beschläge aus Bronze.  
LVIII. Gefäße und Lämpchen aus Bronze.  
LIX. Geschirrbeschläge, Schellen und Schnallen aus Bronze.  
LX. Helmtteile, Waffen- und Messergriffe aus Bronze, Eisen und Bein.  
LXI. Metallspiegel und Griffe aus Bronze.  
LXII. Ärztliche Instrumente aus Bronze.  
LXIII. u. LXIV. Figurale Gegenstände aus Bronze.  
LXV. Bruchstücke von Figuren und Ornamenten aus Bronze.  
LXVI. Schmucksachen aus Gold, Silber, Bronze, Eisen und Glas.  
LXVII. Verschiedenes aus Bronze.  
LXVIII u. LXIX. Schmelzschmuck.  
LXX. Schreibgeräte aus Bronze und Eisen.  
LXXI. Glassachen: Gefäße und Bruchstücke von Fensterscheiben.  
LXXII. Schmuck, Knöpfe und Würfel aus Elfenbein, Knochen und Gagat.  
LXXIII. Graffite auf Gefäßen aus Terra sigillata.  
LXXIV. Graffite auf Ziegeln.  
LXXV—LXXVII. Ziegelstempel der XXII. Legion.  
LXXVIII. Ziegelstempel der XXII. und VIII. Legion.  
LXXIX. Ziegelstempel der Kohorten und Privatziegler.  
LXXX. Gegenstände aus Holz und Leder, besonders Schuhwerk.

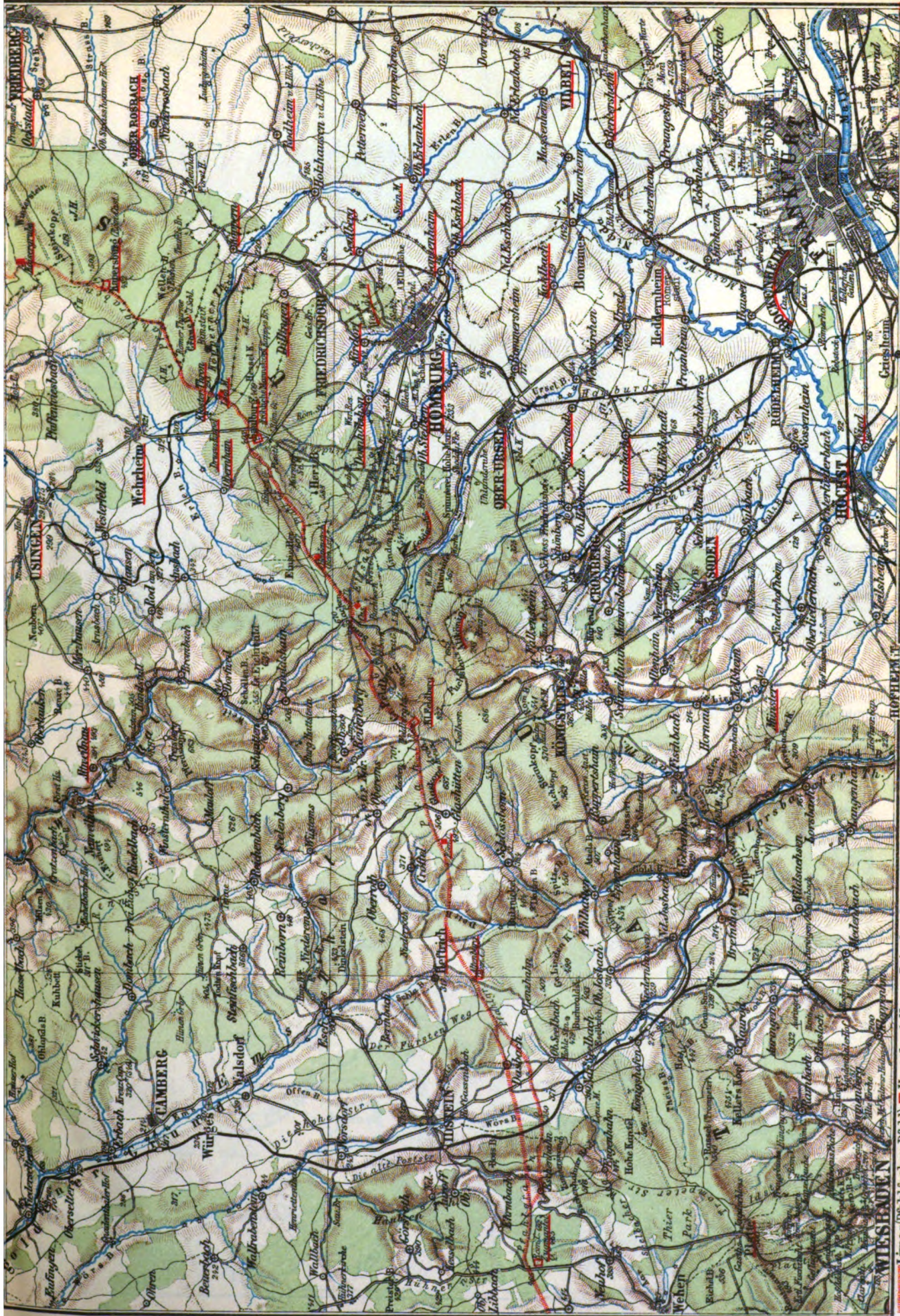

■ Hauptkastele ■ Zwischenkastele — Orte die im Texte genannt sind.

Limes (Plattgraben, Pfahl). □ Wiesbaden □ Homburg □ Kronberg □ Bamberg □ Wehrheim □ Hohenheim □ Hohenheim II.

Maassstab 1:170,000. — 0 1 2 3 4 5 6 7 8 9 10 Kilometer.



# LAGE DER SAALBURG.

Die Saalburg.

Plan und Ansicht des Taunus.

TAFEL I.

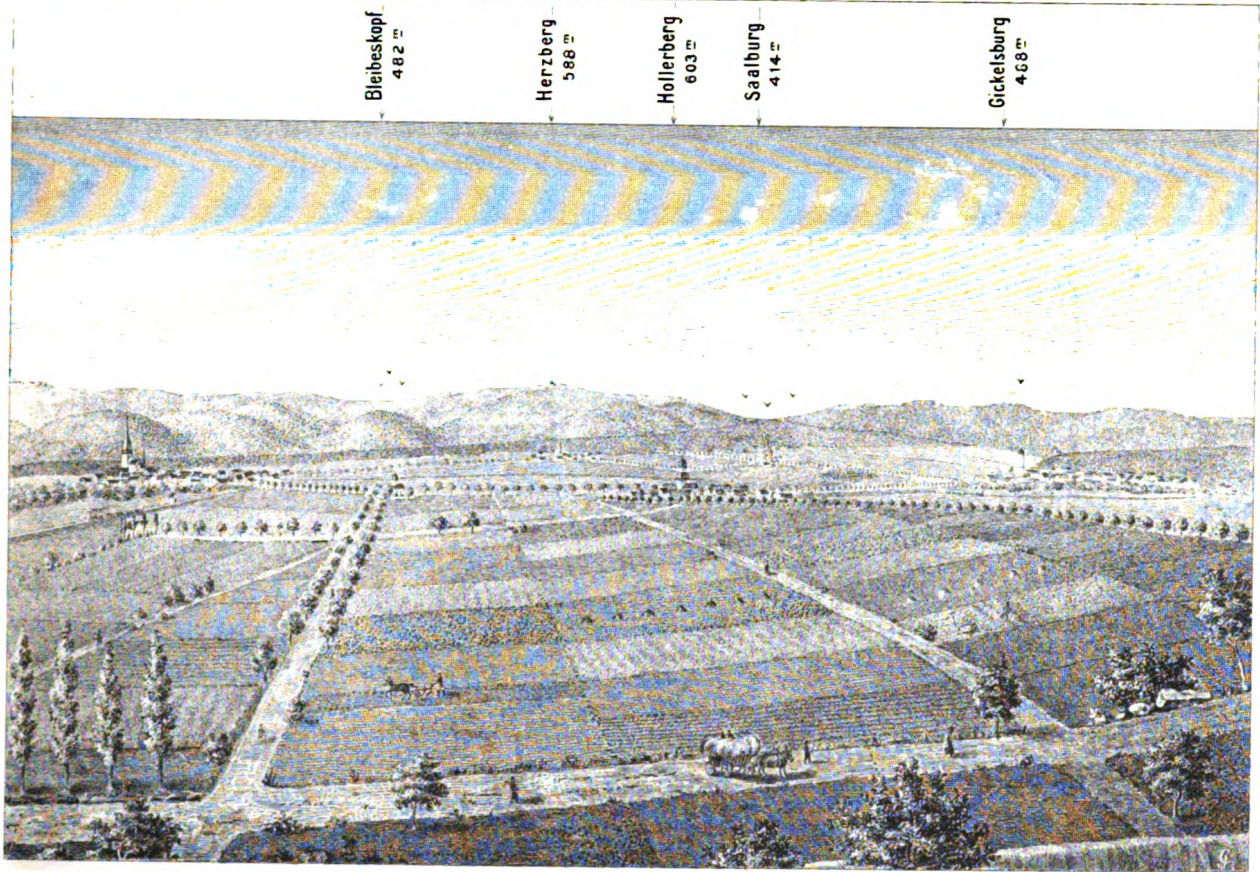

Bleibeskopf 482 m  
 Herzberg 588 m  
 Hollenberg 603 m  
 Saalburg 414 m  
 Gickelsburg 468 m

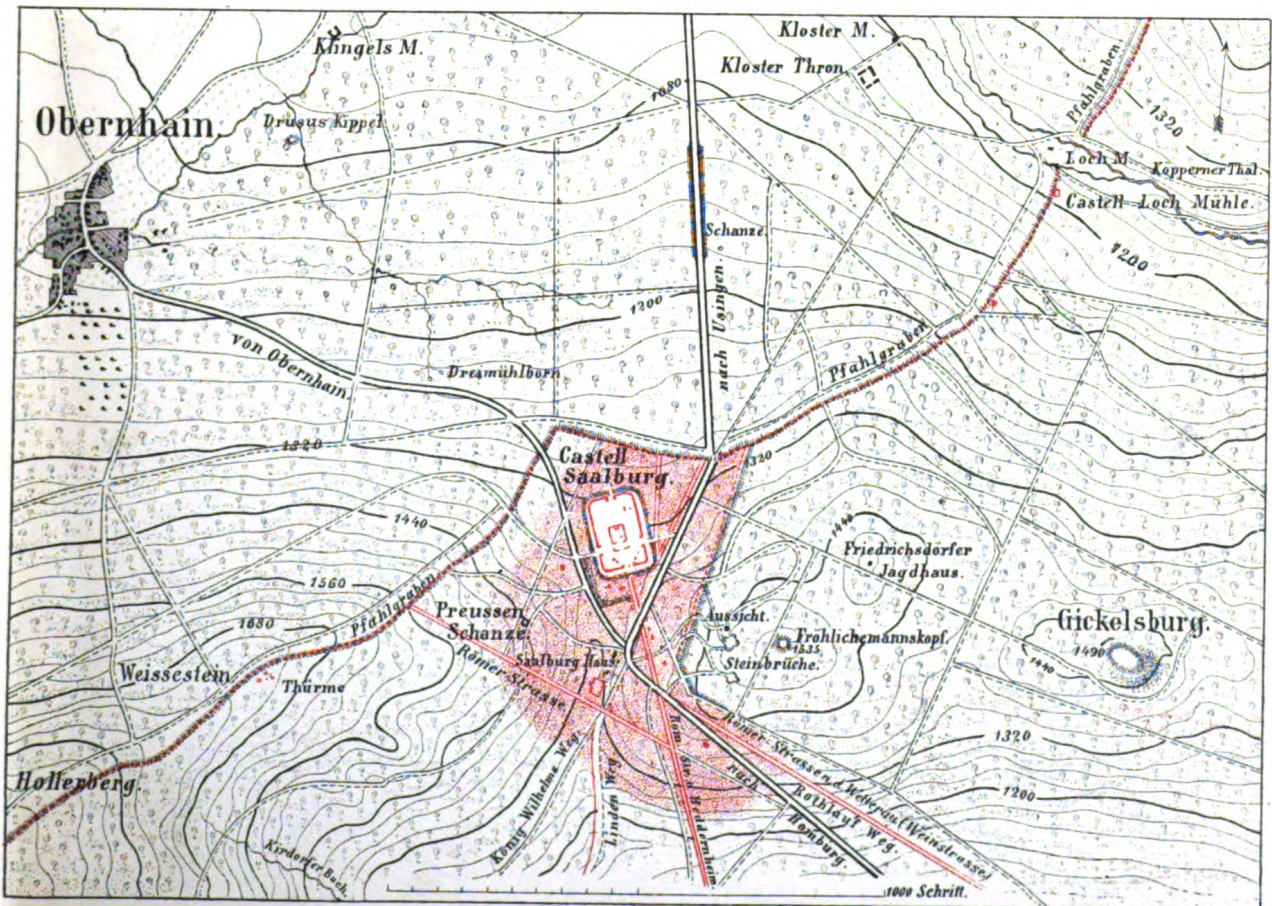



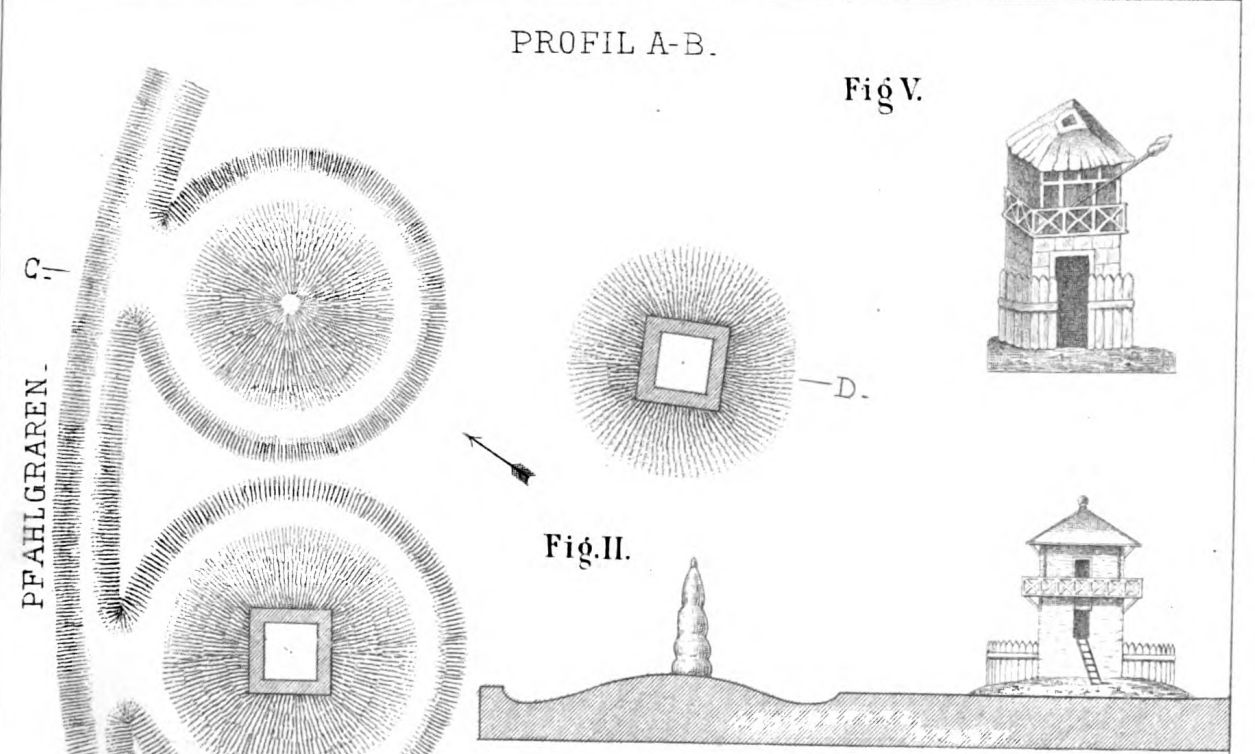
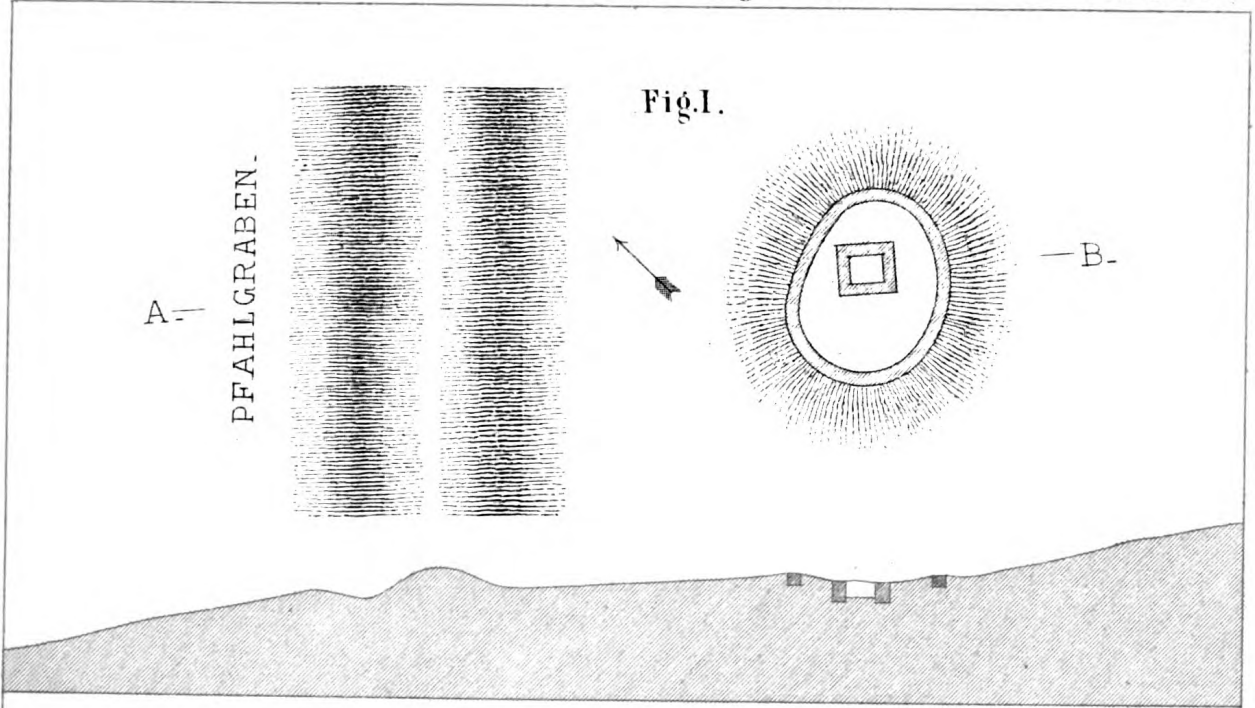

PROFIL A-B.

Fig.V.

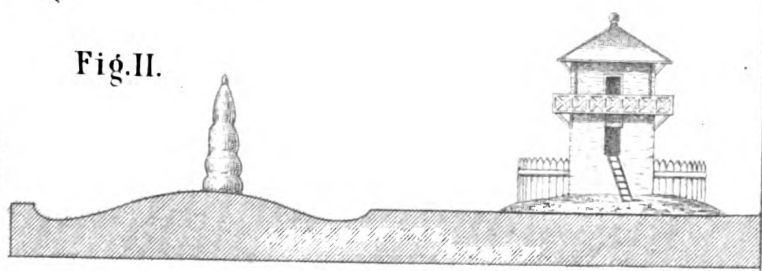
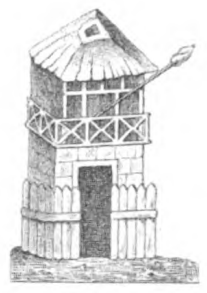

PROFIL C-D.

Fig.IV.

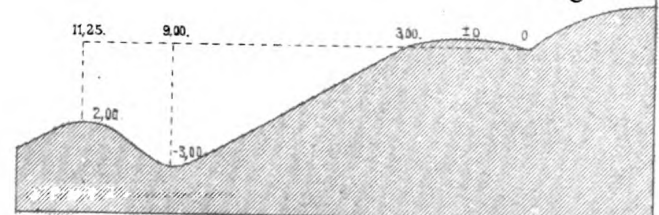
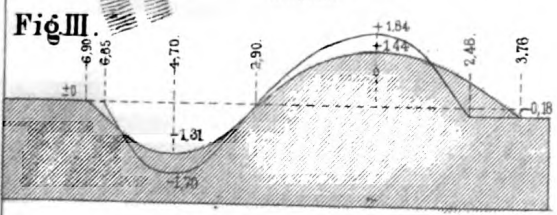

METER-FIG. III-IV.

METER-FIG. I & II.



# CASTELL LOCHMUEHLE MIT PFAHLGRABEN.

Die Saalburg.

Ringwall Gickelsburg.

TAFEL III.

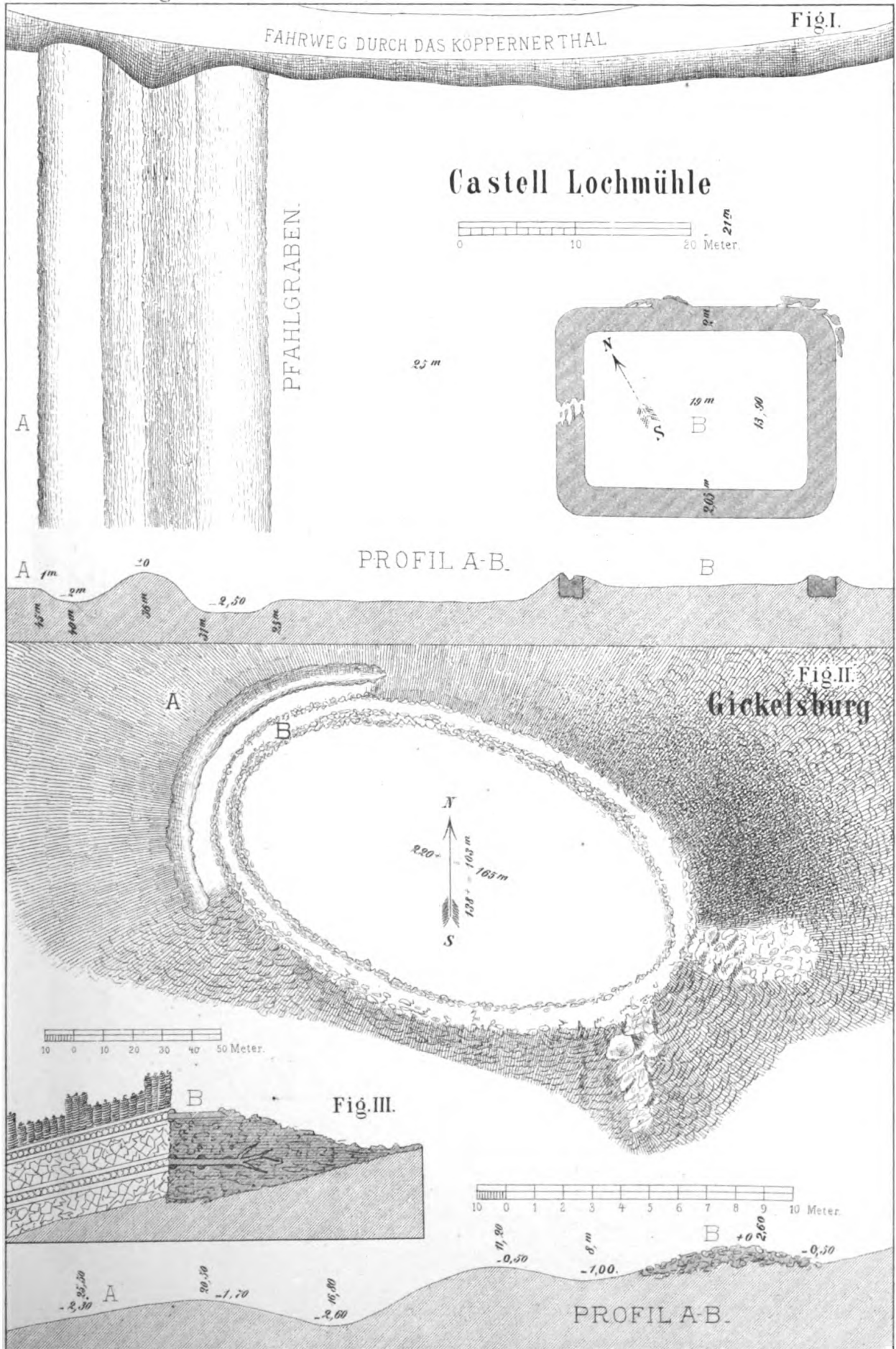





# KASTELL SAALBURG.

Grundriss

TAFEL IV.

Die Saalburg.

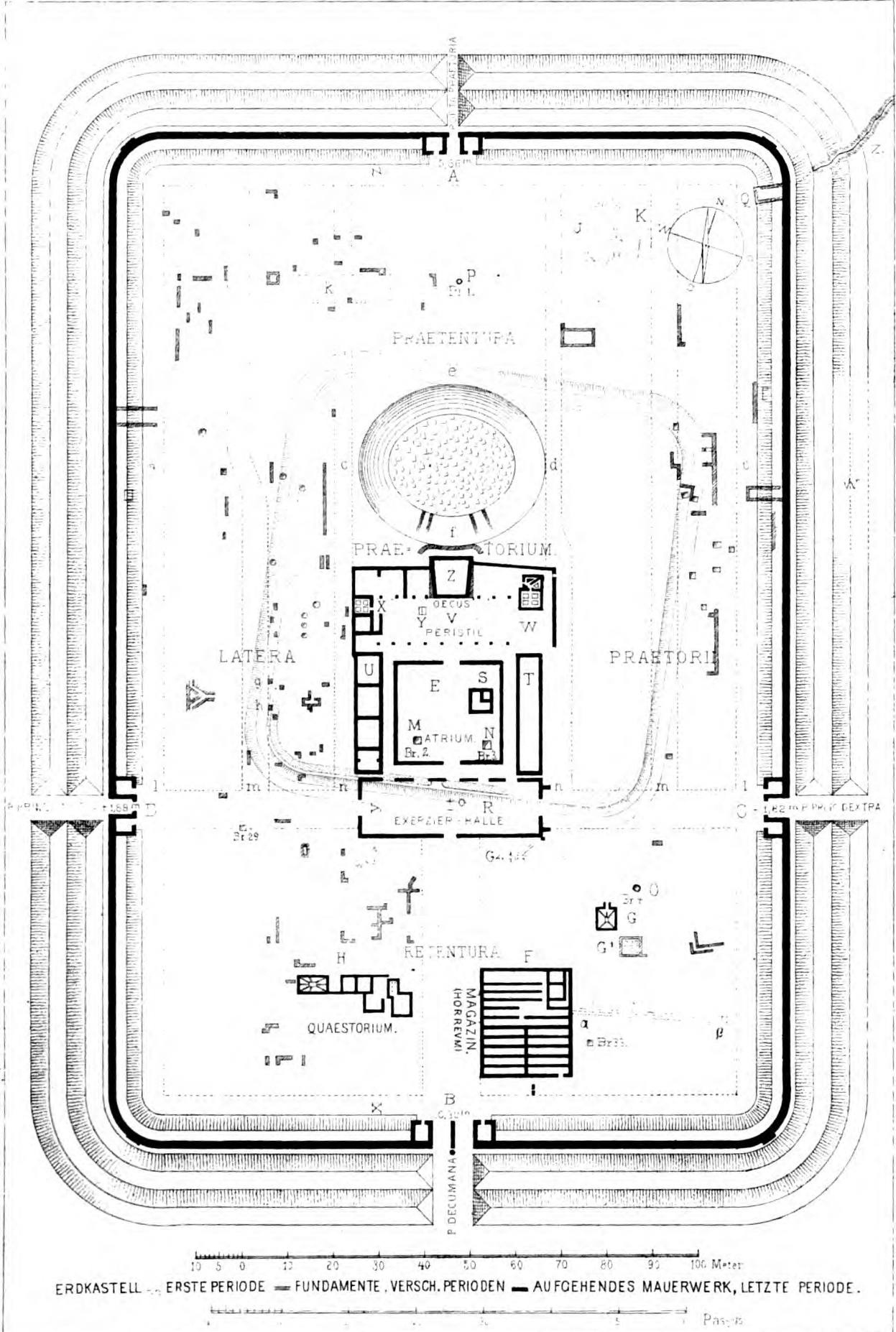



# SAALBURG

Die Saalburg.

Vogelperspective.

TAFEL V.

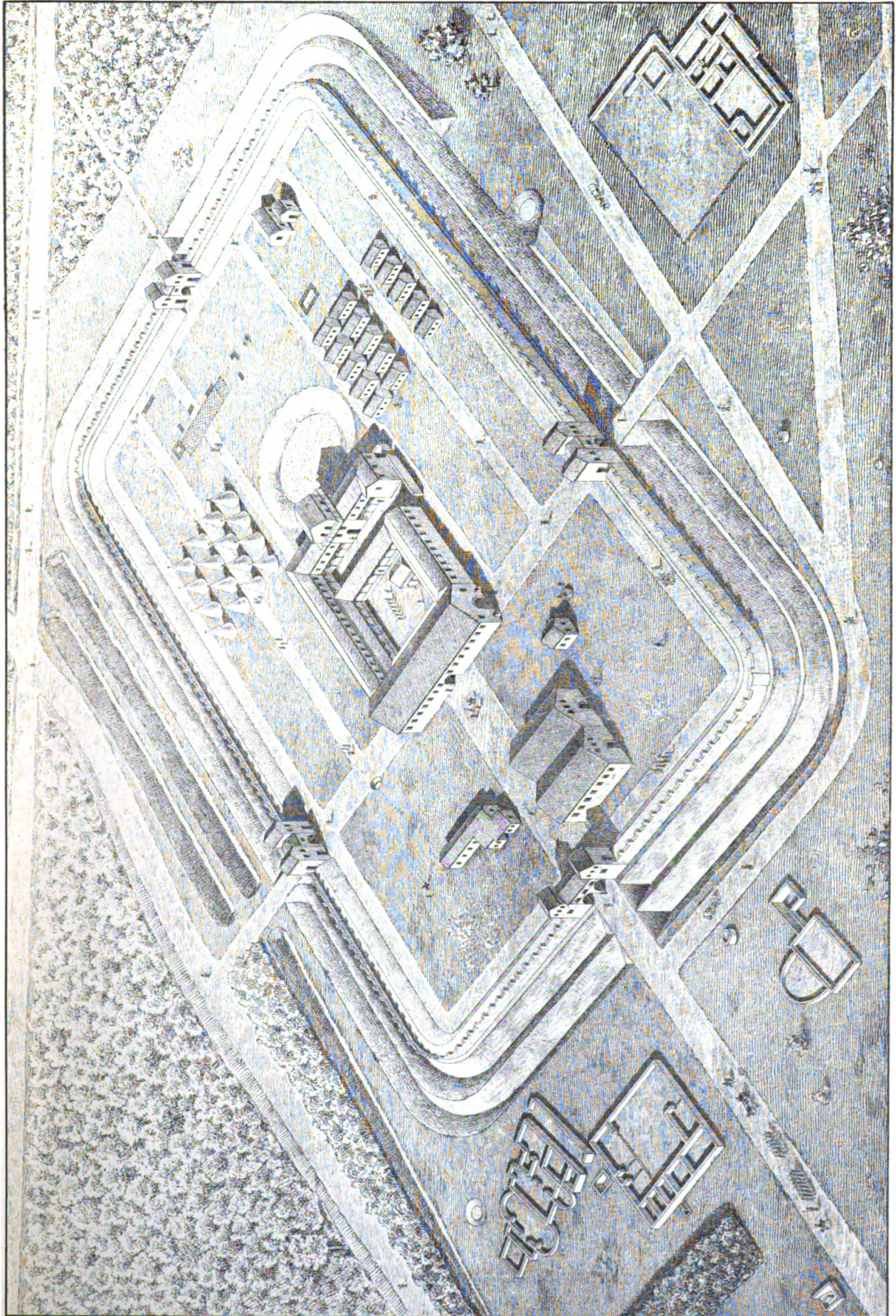

A. Pauli, Lith. Anst. Homburg.



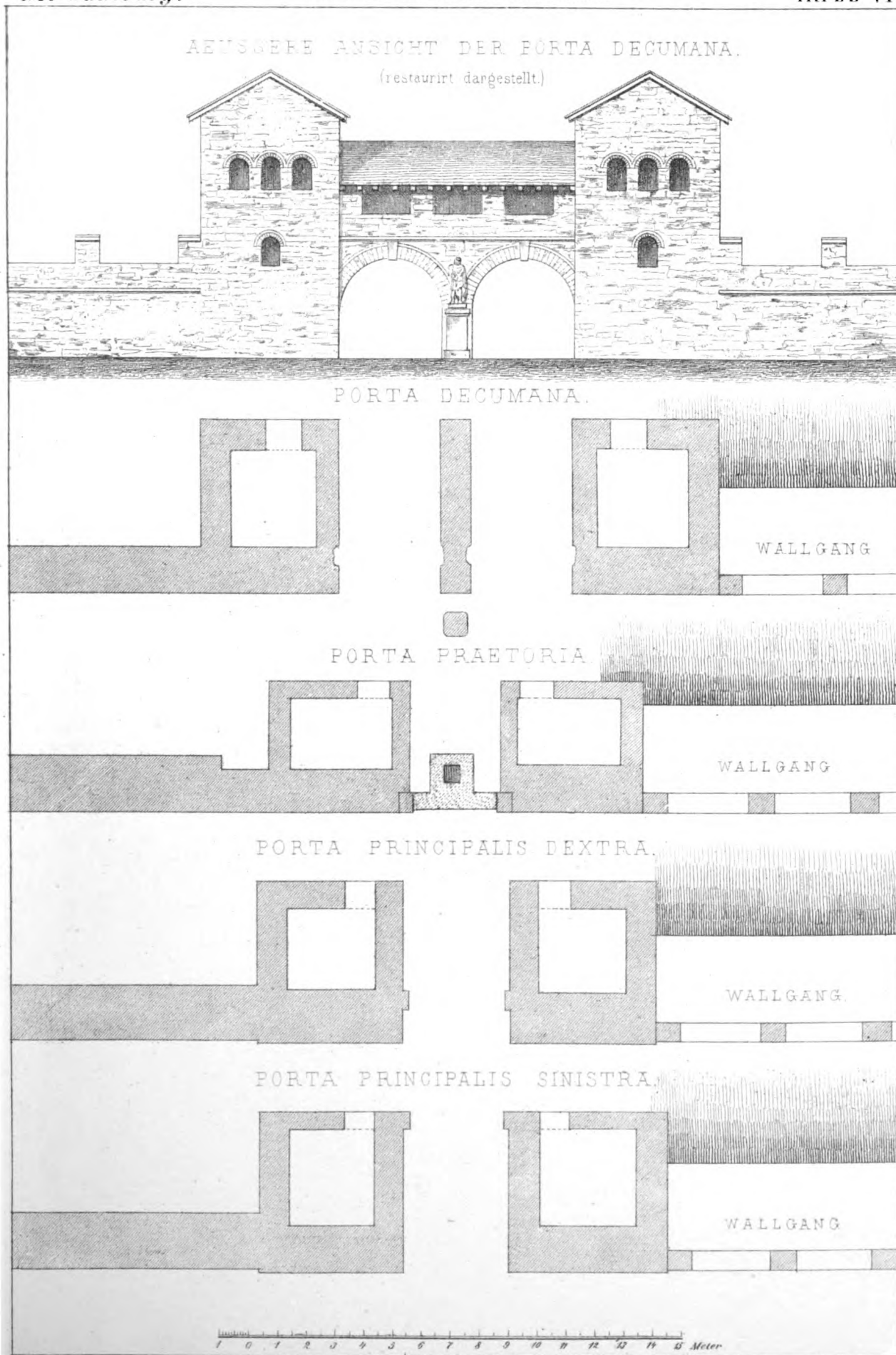



# AMPHITHEATER, BRUNNEN & VERSCH. BAURESTE.

Die Saalburg.

im Castell.

TAFEL VII.

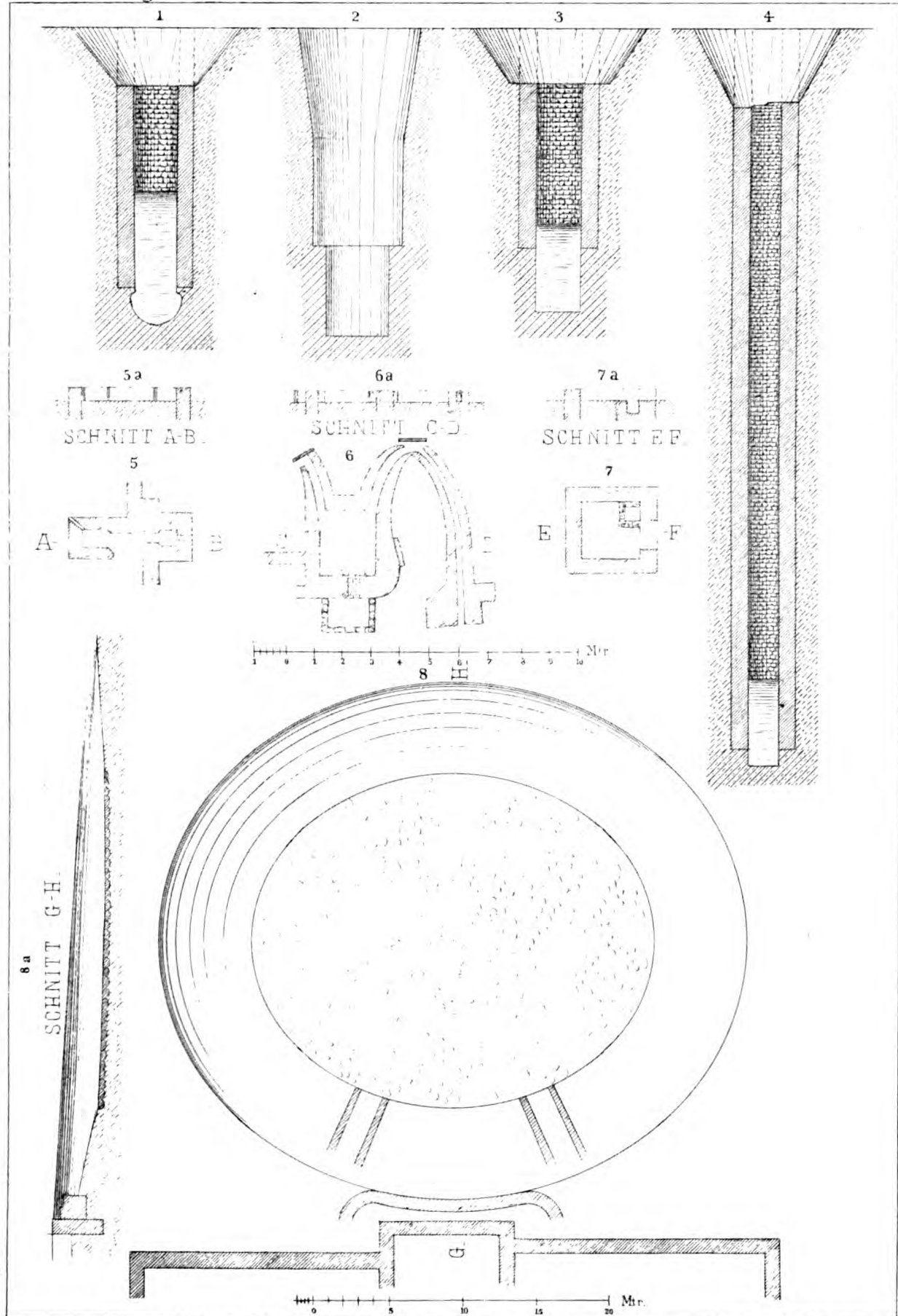





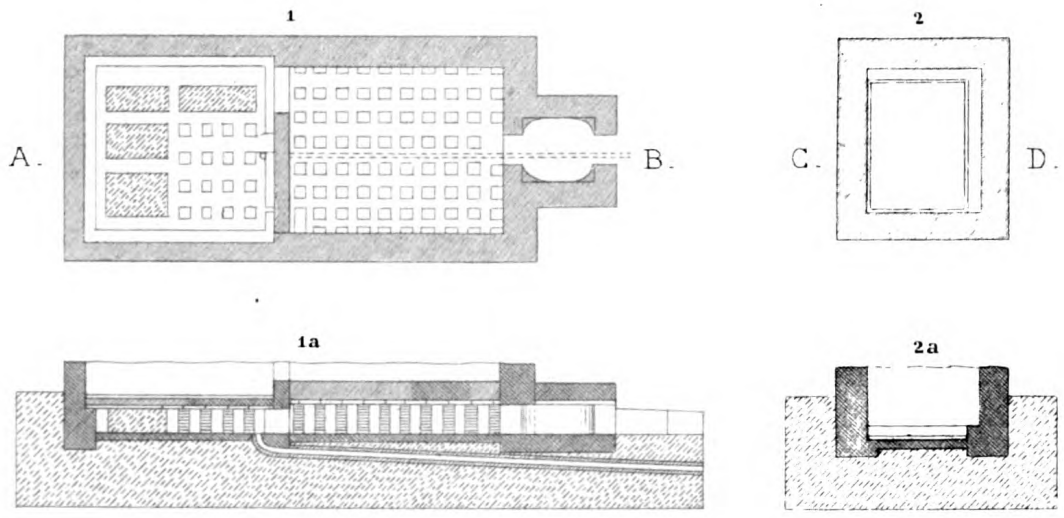

SCHNITT-A-B-

SCHNITT-C-D-

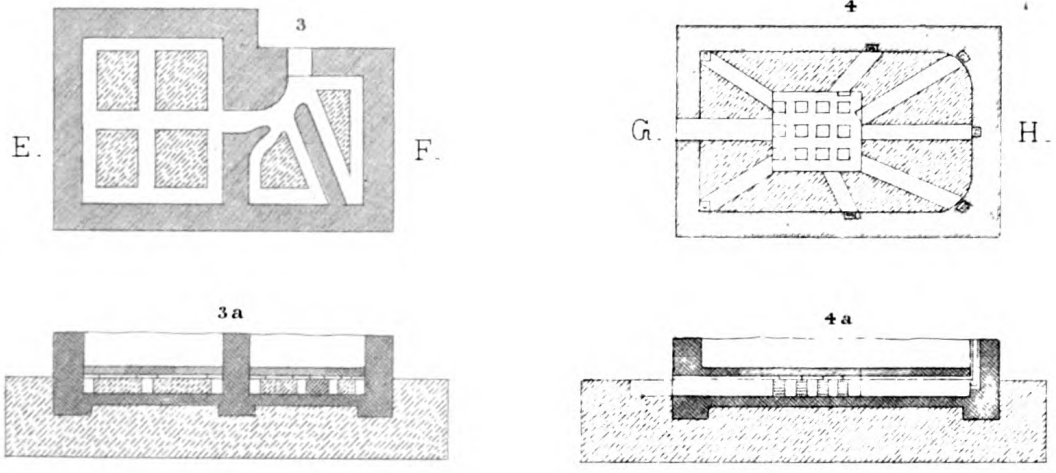

SCHNITT E-F-

SCHNITT-G-H-

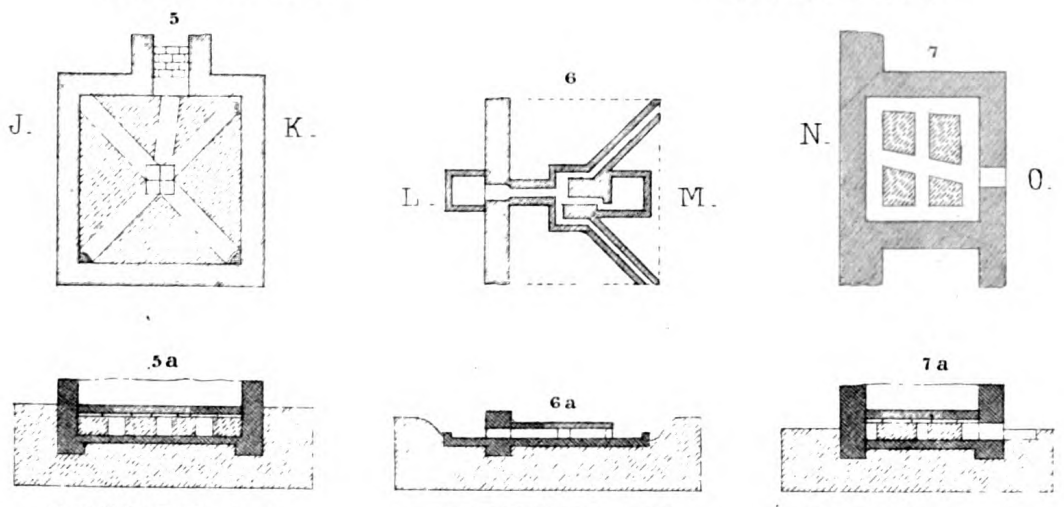

SCHNITT-J-K-

SCHNITT-L-M-

SCHNITT-N O

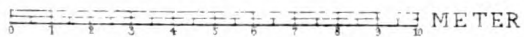



PROFIL

Fig. I.



PROFIL

Fig. II.



M-X-W-

PROFIL

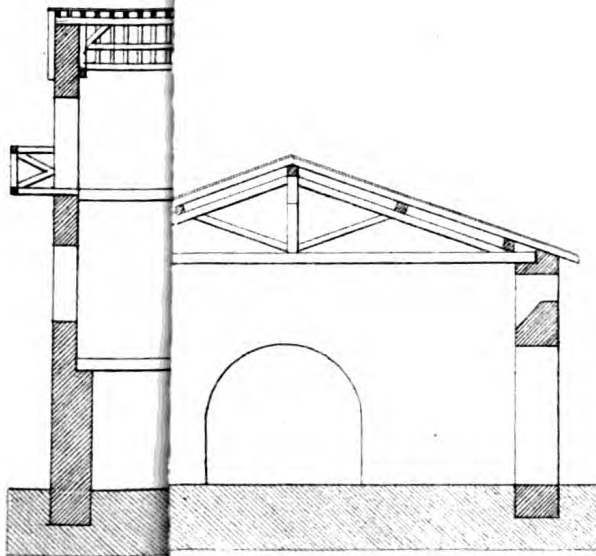
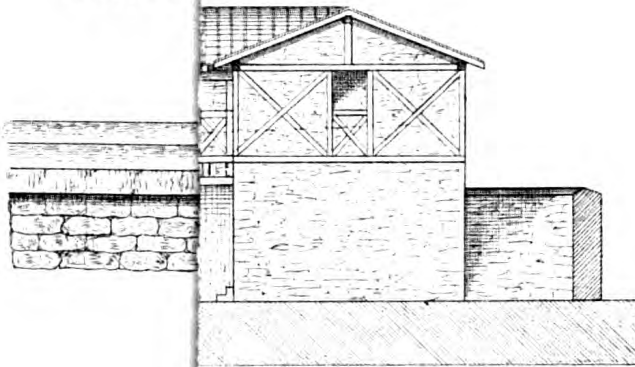

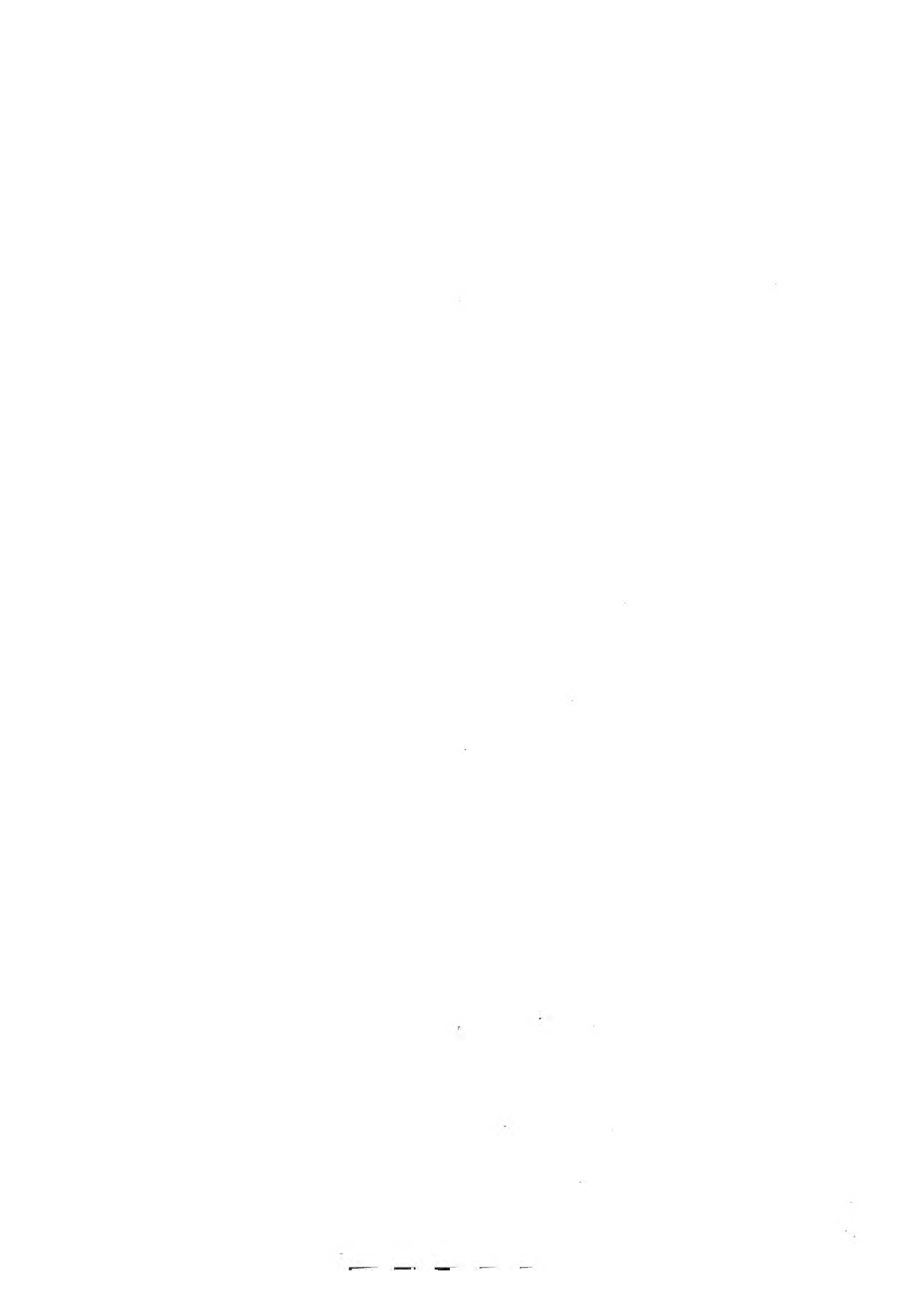

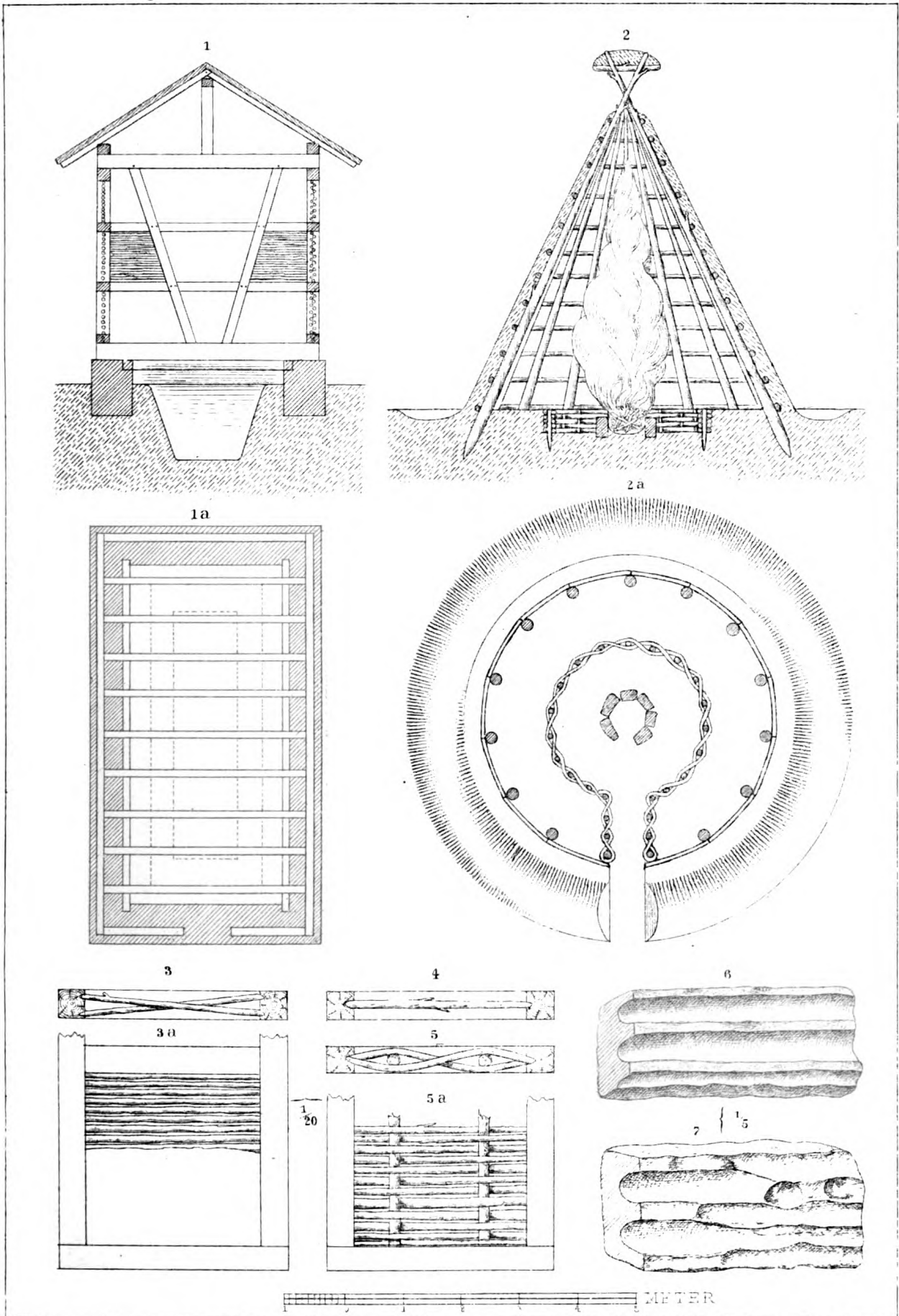



EIN RÖMISCHER LEGIONAR

Die Saalburg. mit Pilum, Gladius, Helm und Schild.

TAFEL. XII.



Ein Zehntel d. nat. Gröfse.





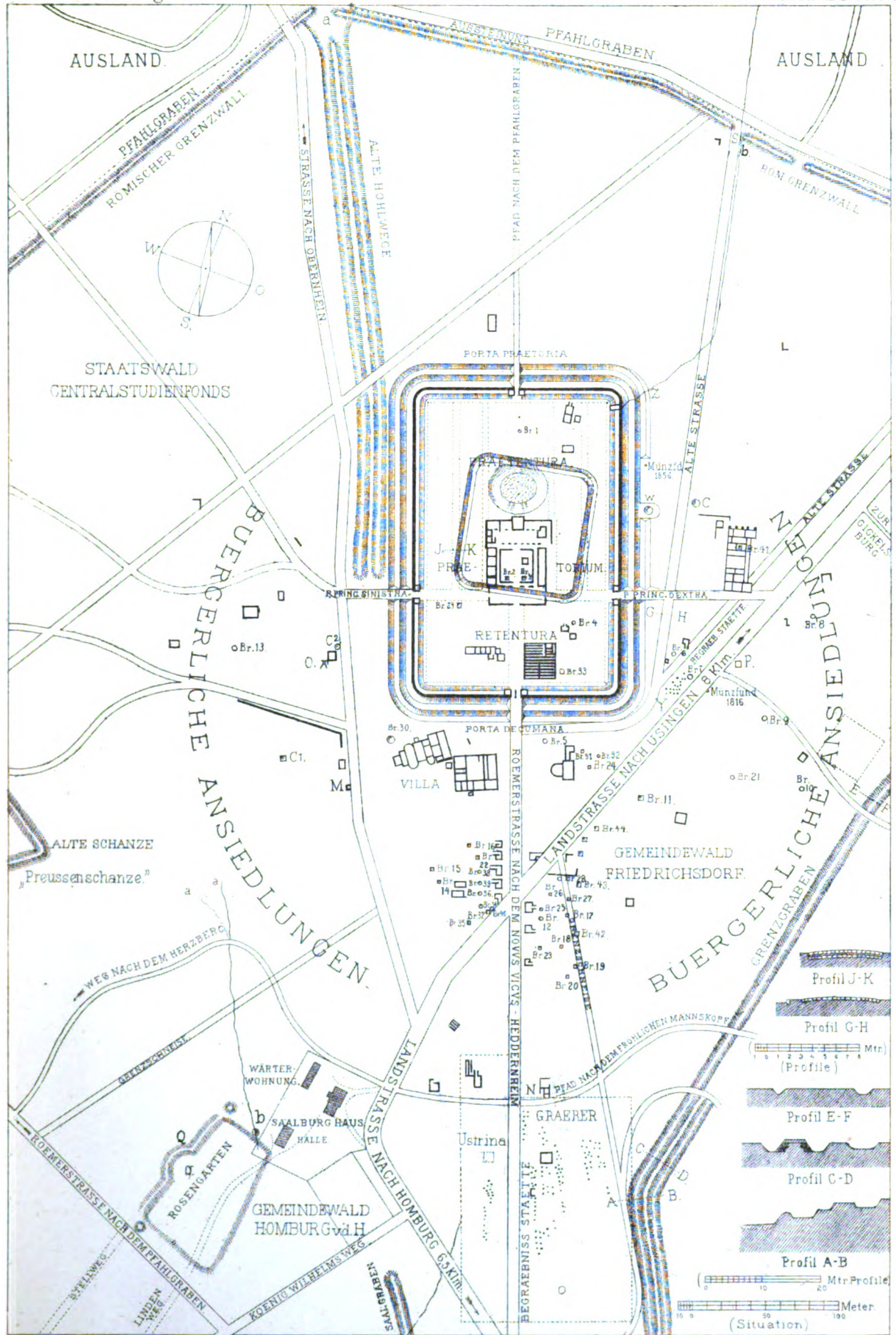

---

1

1

1

1

1

---

# HYPOCAUSTENBAU, BRUNNEN u. FUNDSTÜCKE

Die Saalburg.

aus derselben Bürgerliche Niederlassung.

TAFEL XIV.

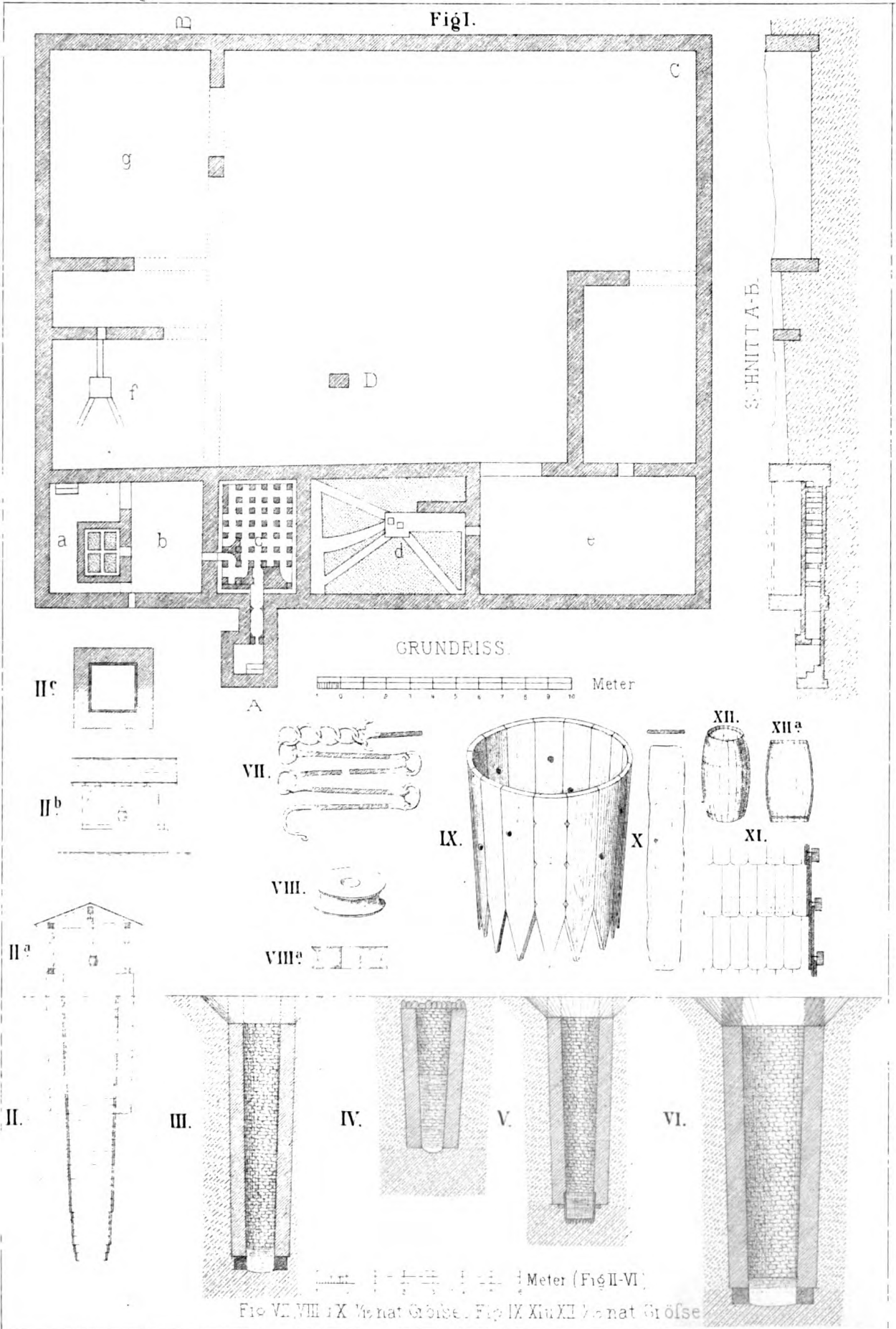

\_\_\_\_\_

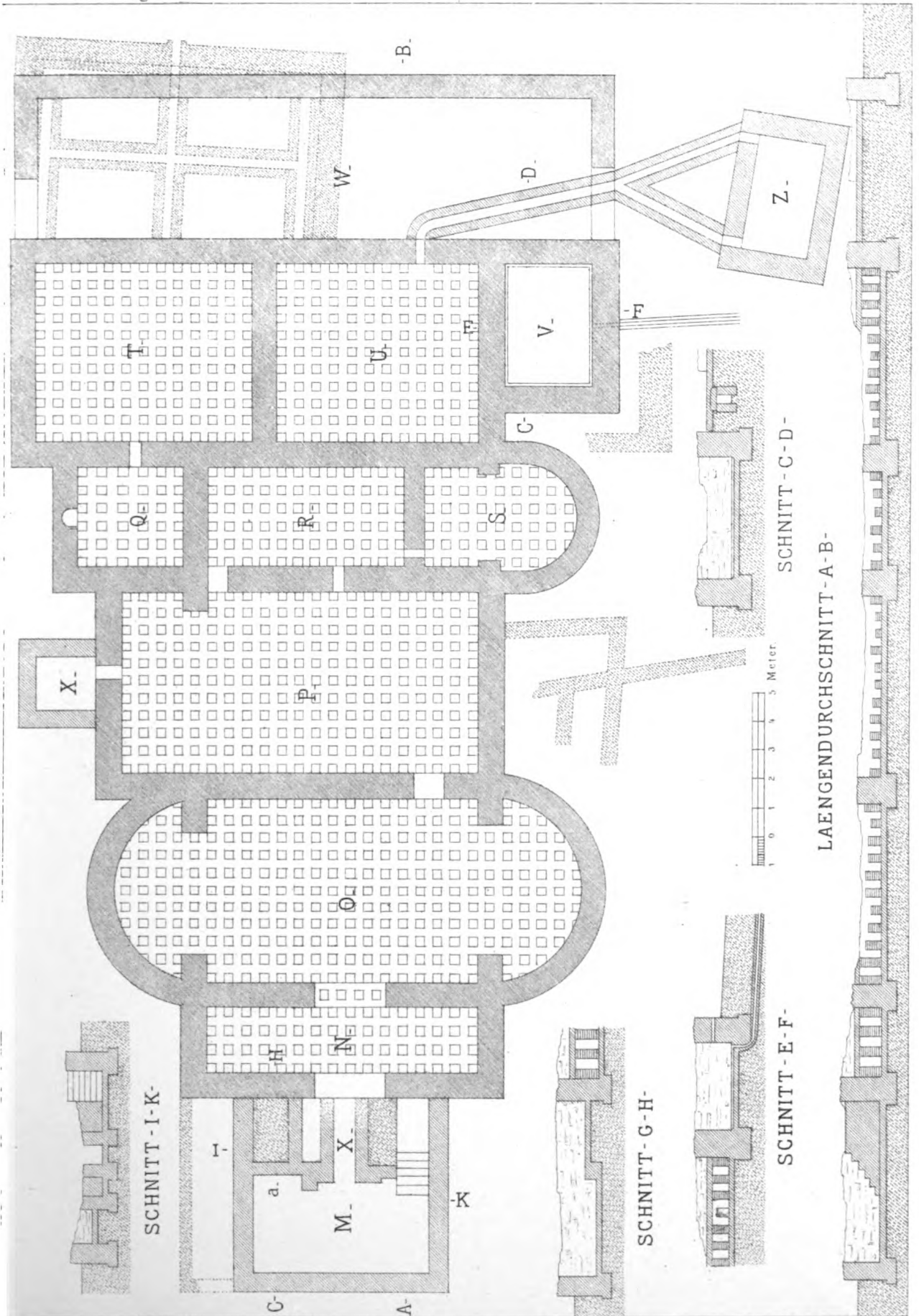

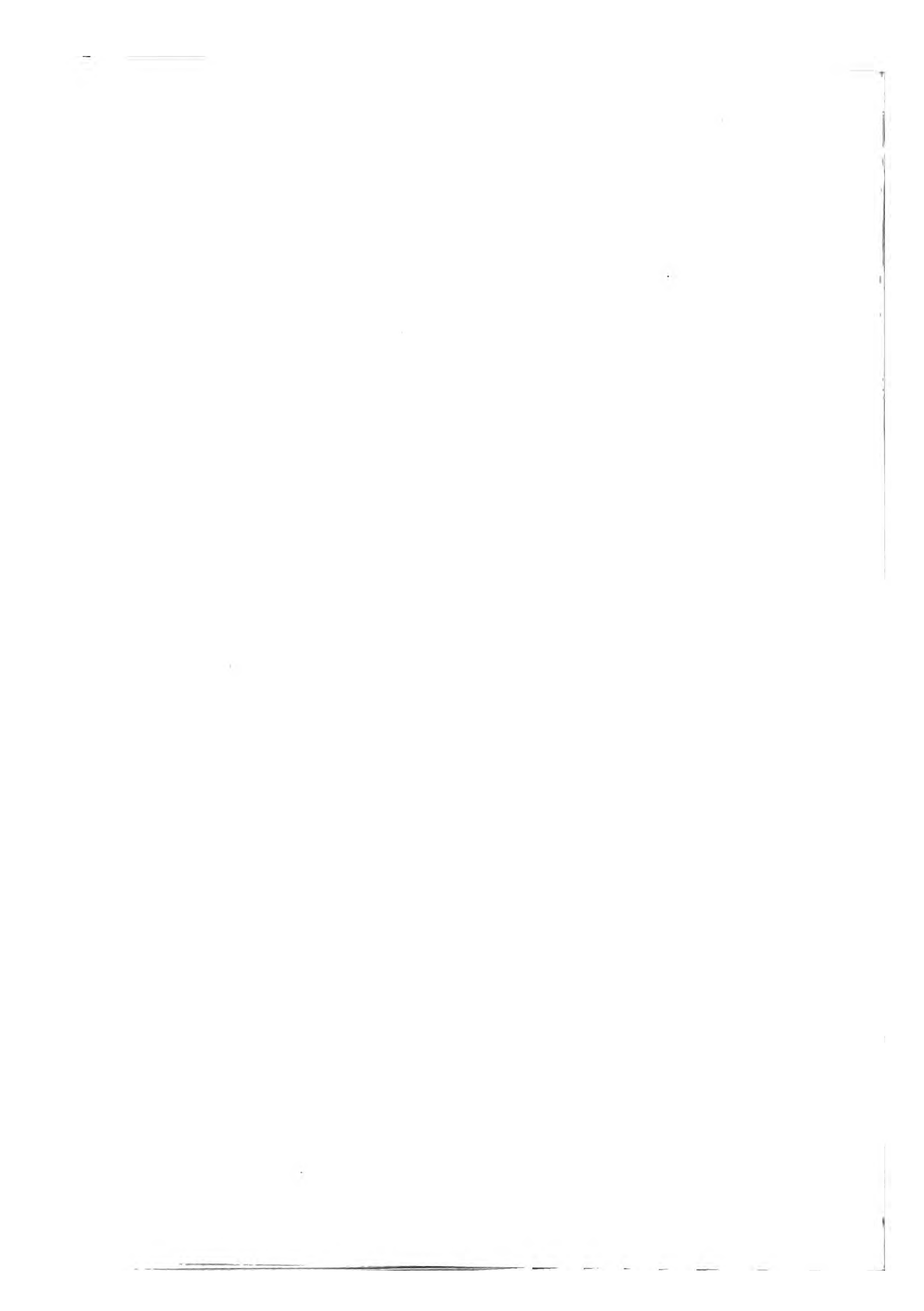

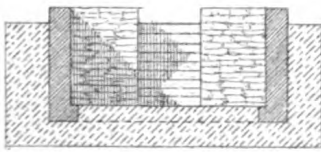
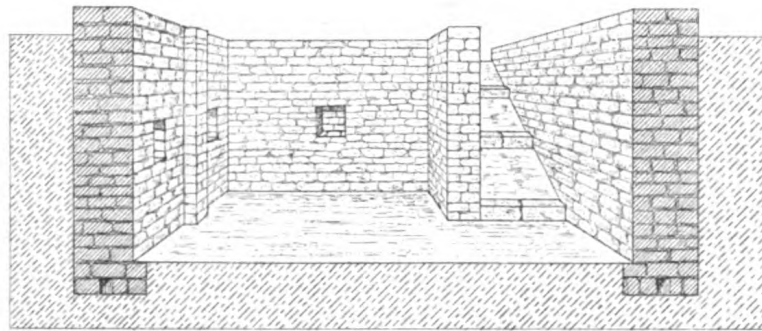

SCHNITT-A-B-



SCHNITT-C-D-



SCHNITT-E-F-

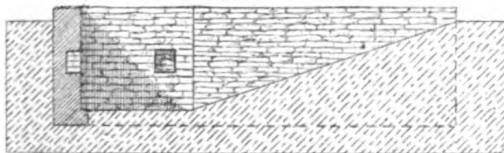

SCHNITT-G-H-

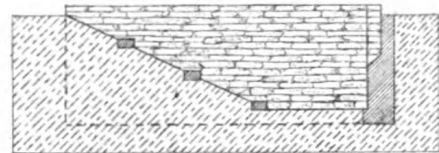

SCHNITT-J-K-

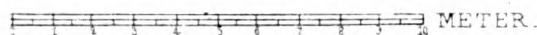
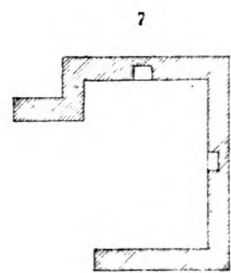
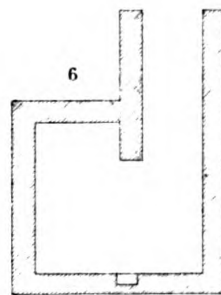
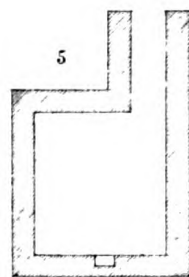
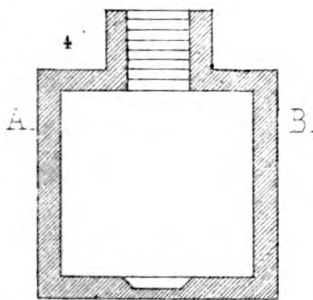
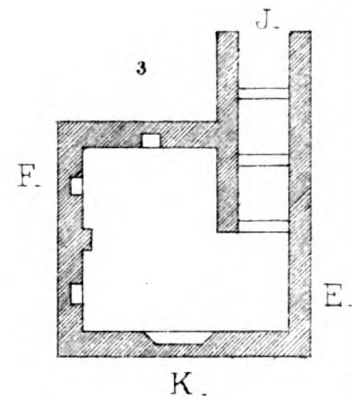
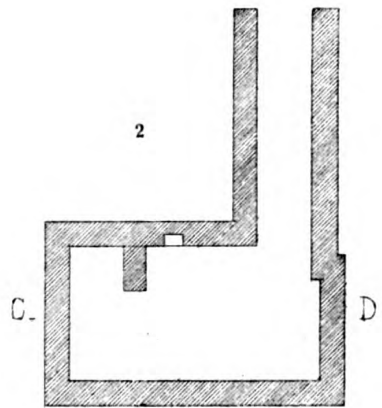
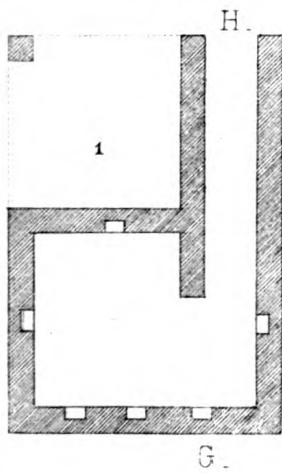





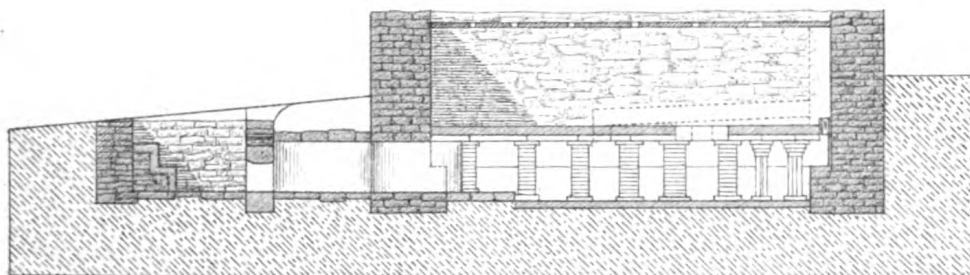

SCHNITT-A-B-

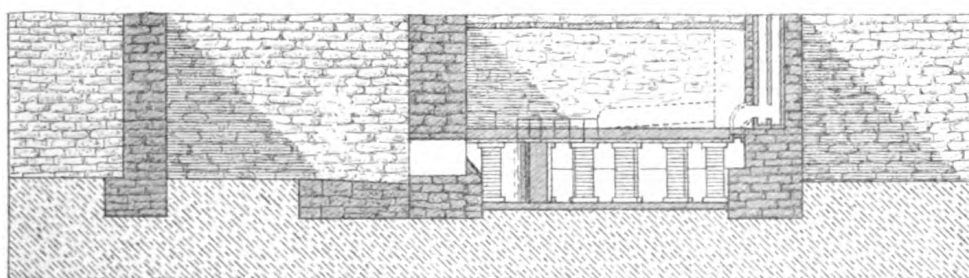

SCHNITT-C-D-

B

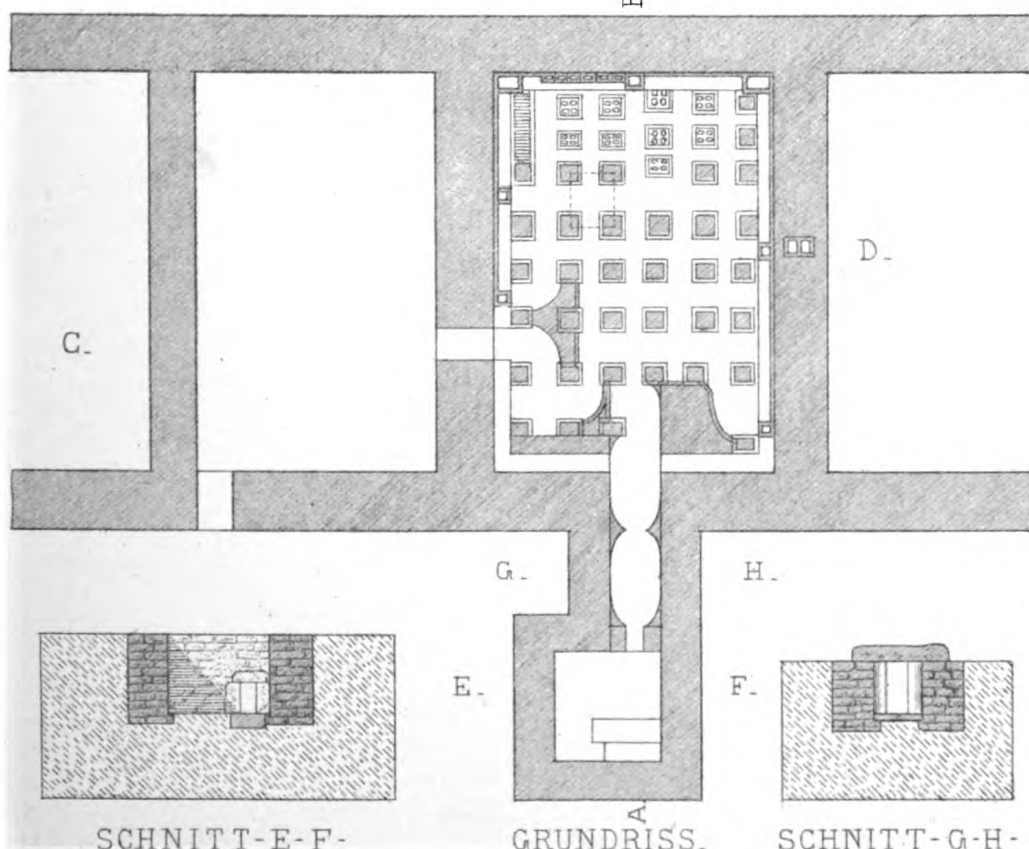

SCHNITT-E-F-

GRUNDRISS.

SCHNITT-G-H-

0 1 2 3 4 5 6 7 8 9 10 METER.



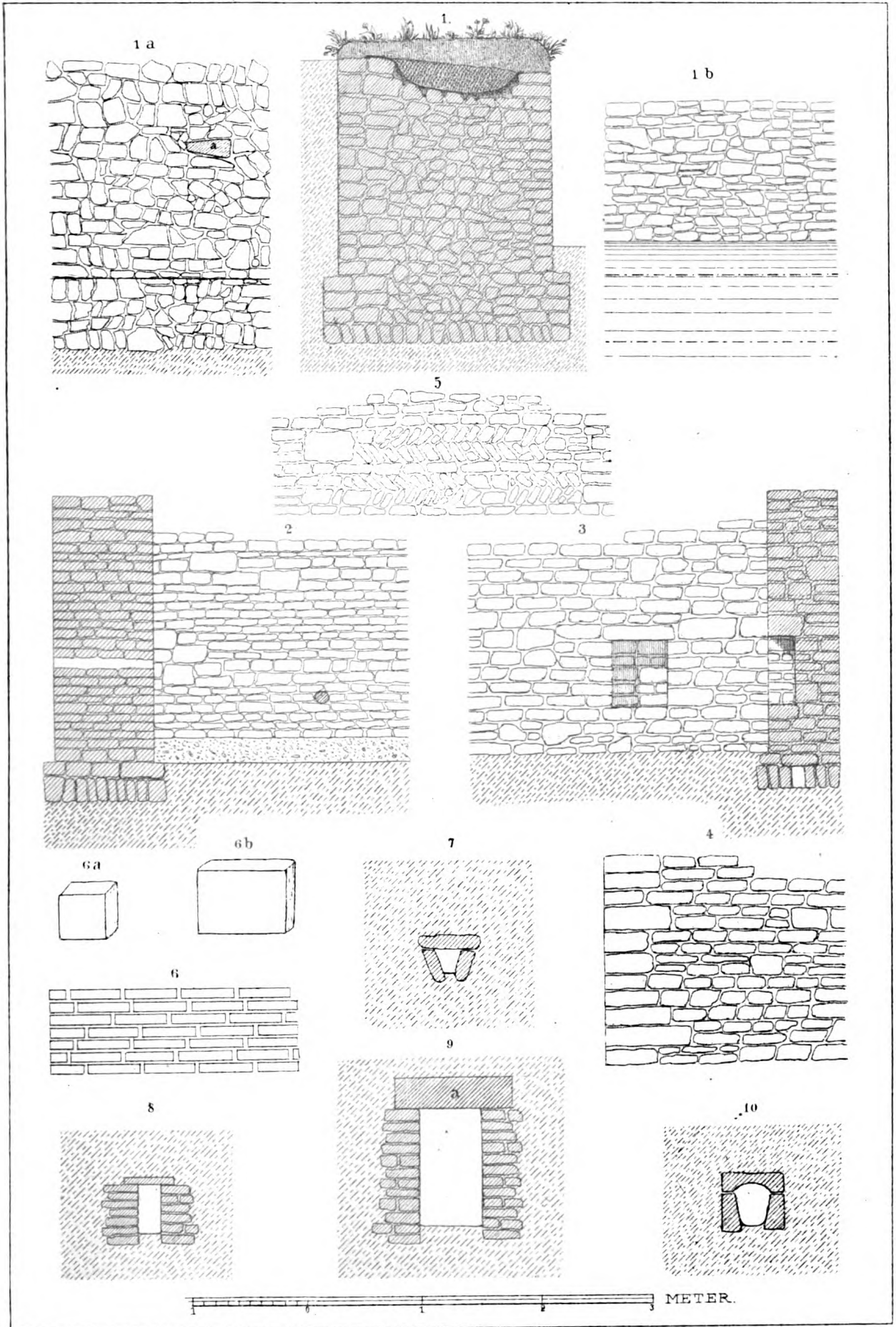



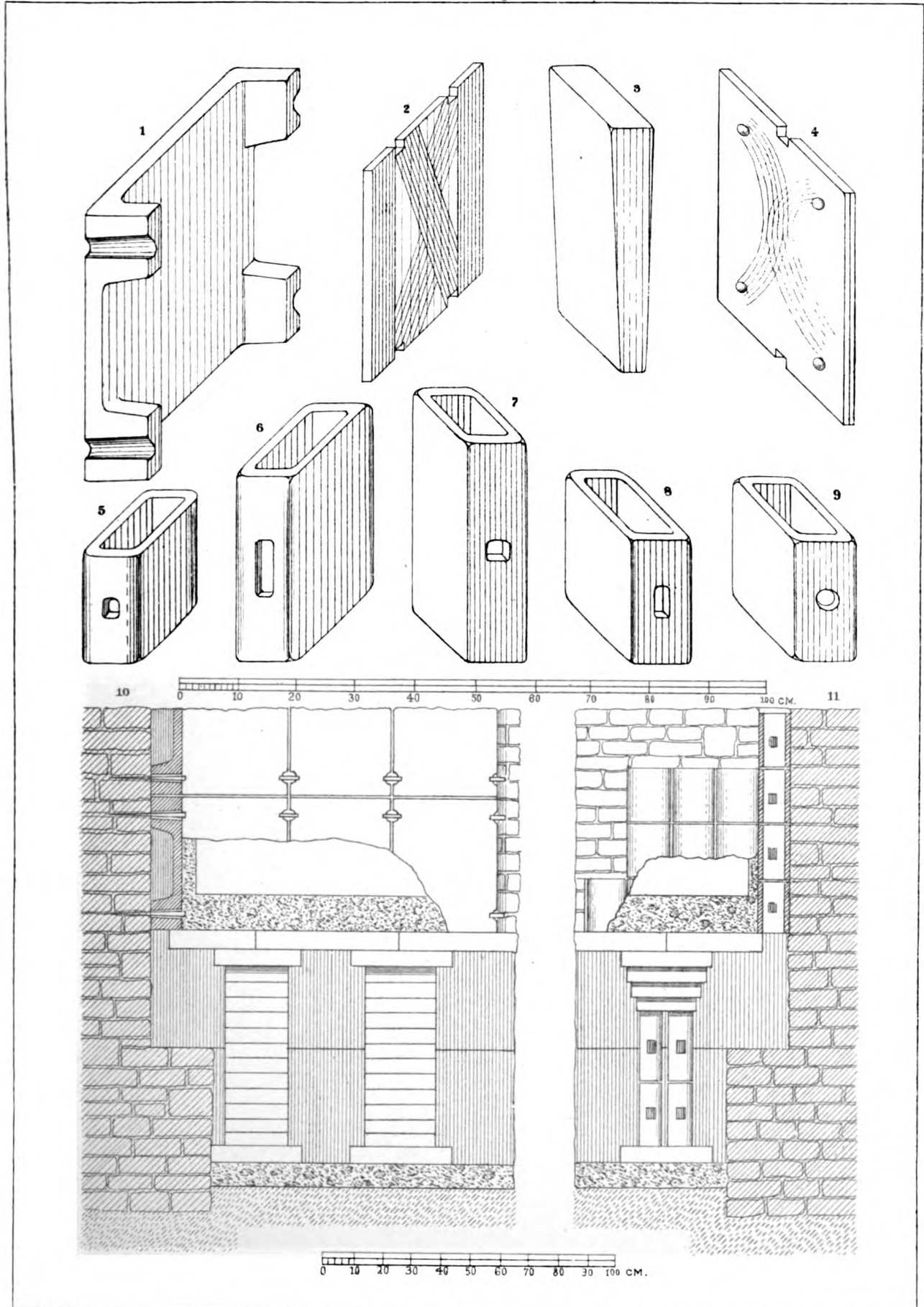

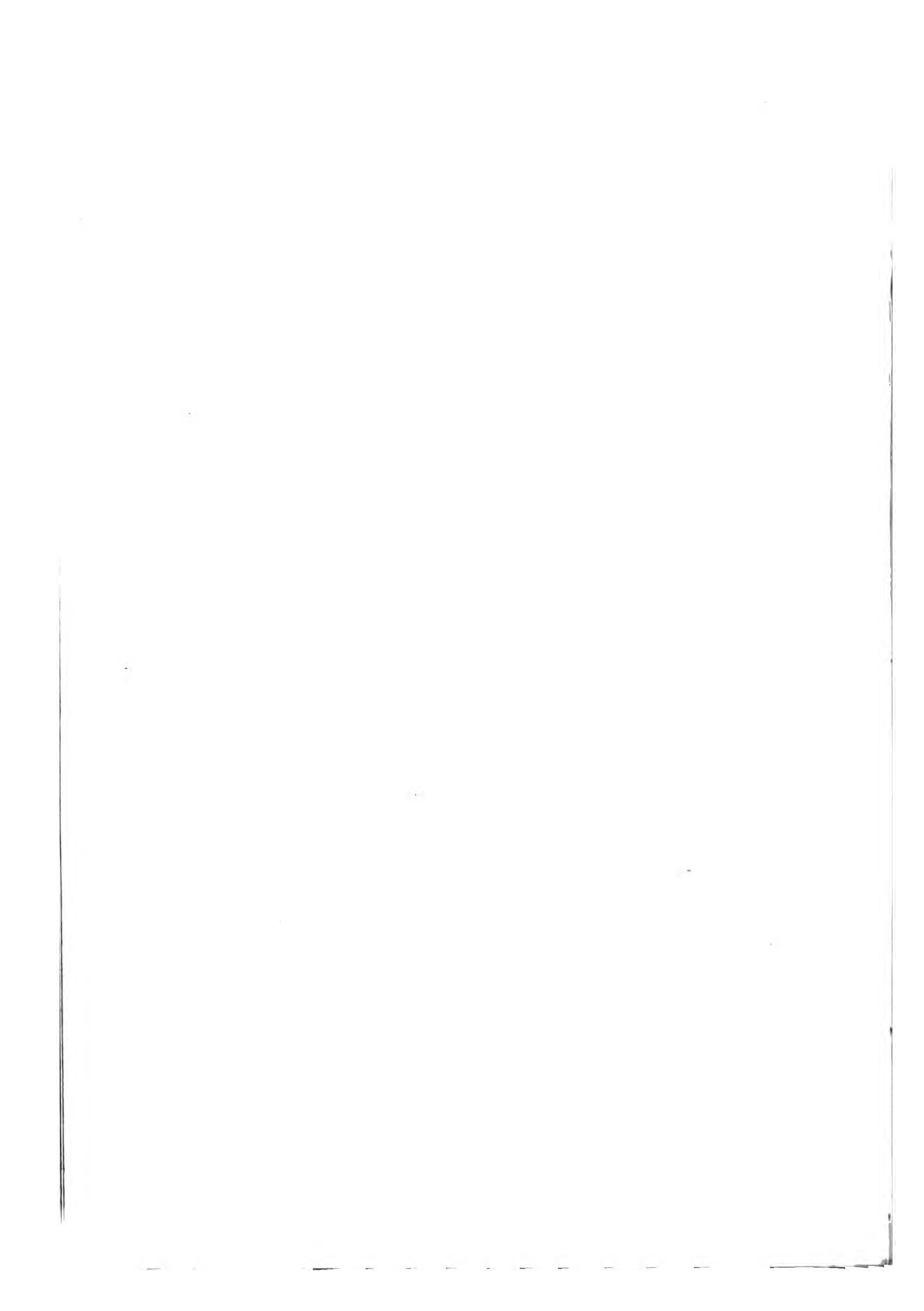

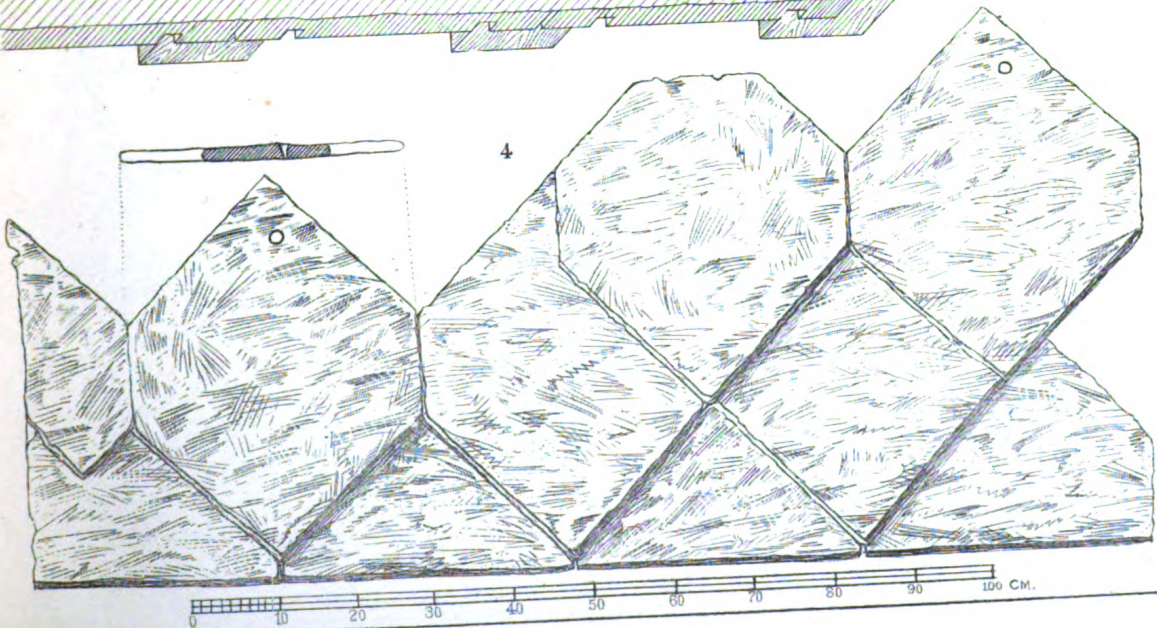
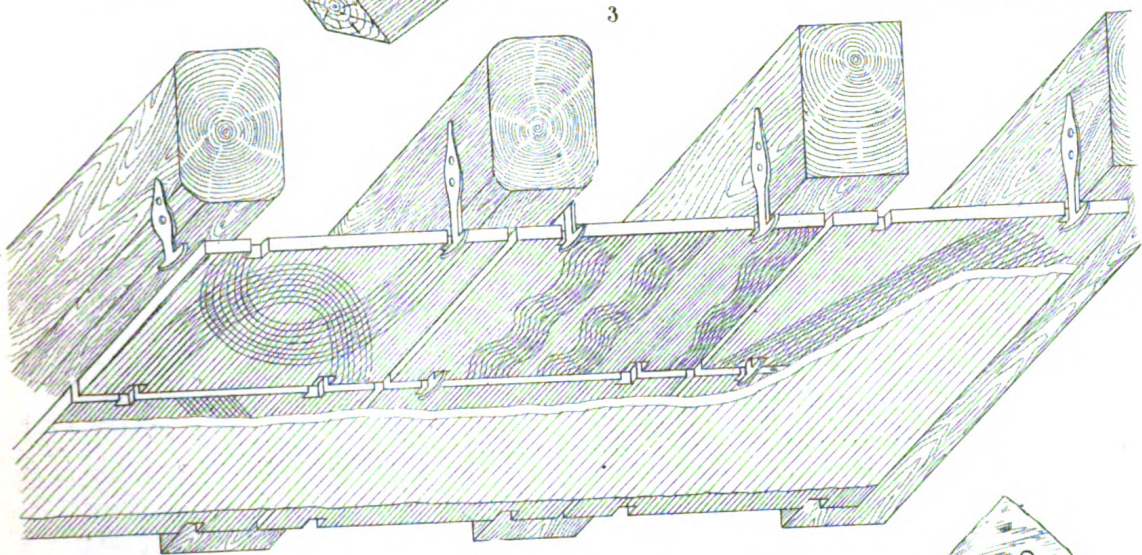
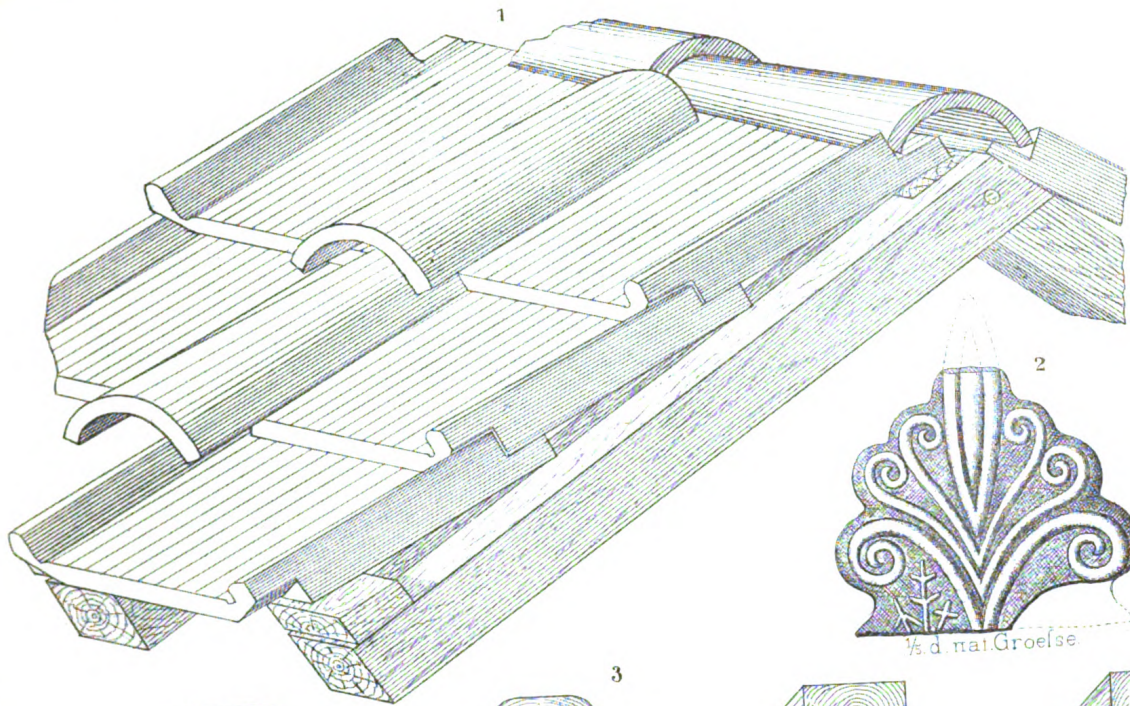





# BAULICHE DETAILS.

Die Saalburg.

Profilirte Steine.

TAFEL XXI.

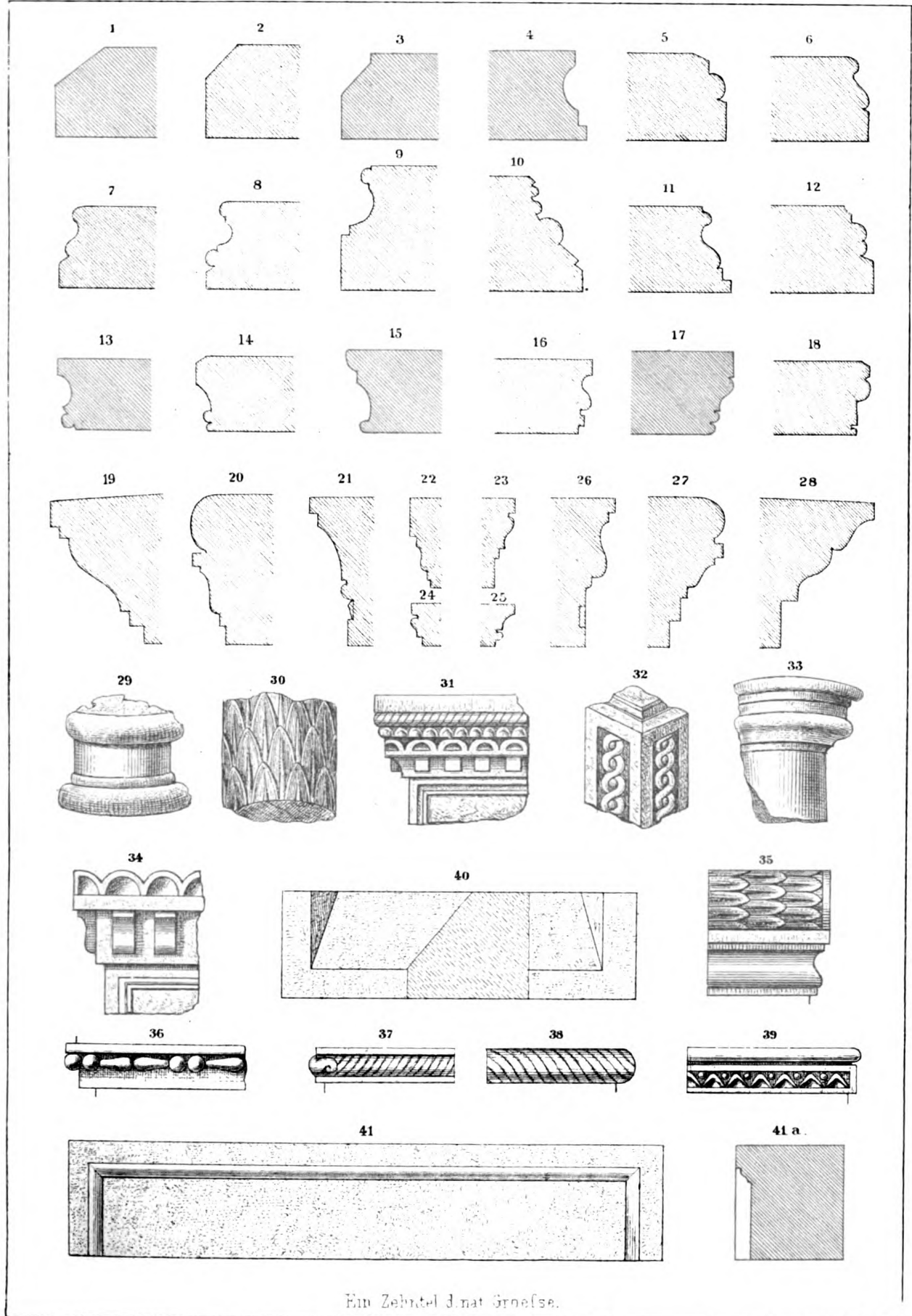

Ein Zehntel d. nat. Gröfse.

Saalburg-Museum, Homburg v. d. H.

A. Pauli Lith. Anst. Homburg



# SITVATIONSPLAN DER GRAEBER.

Die Saalburg.

TAFEL. XXII.

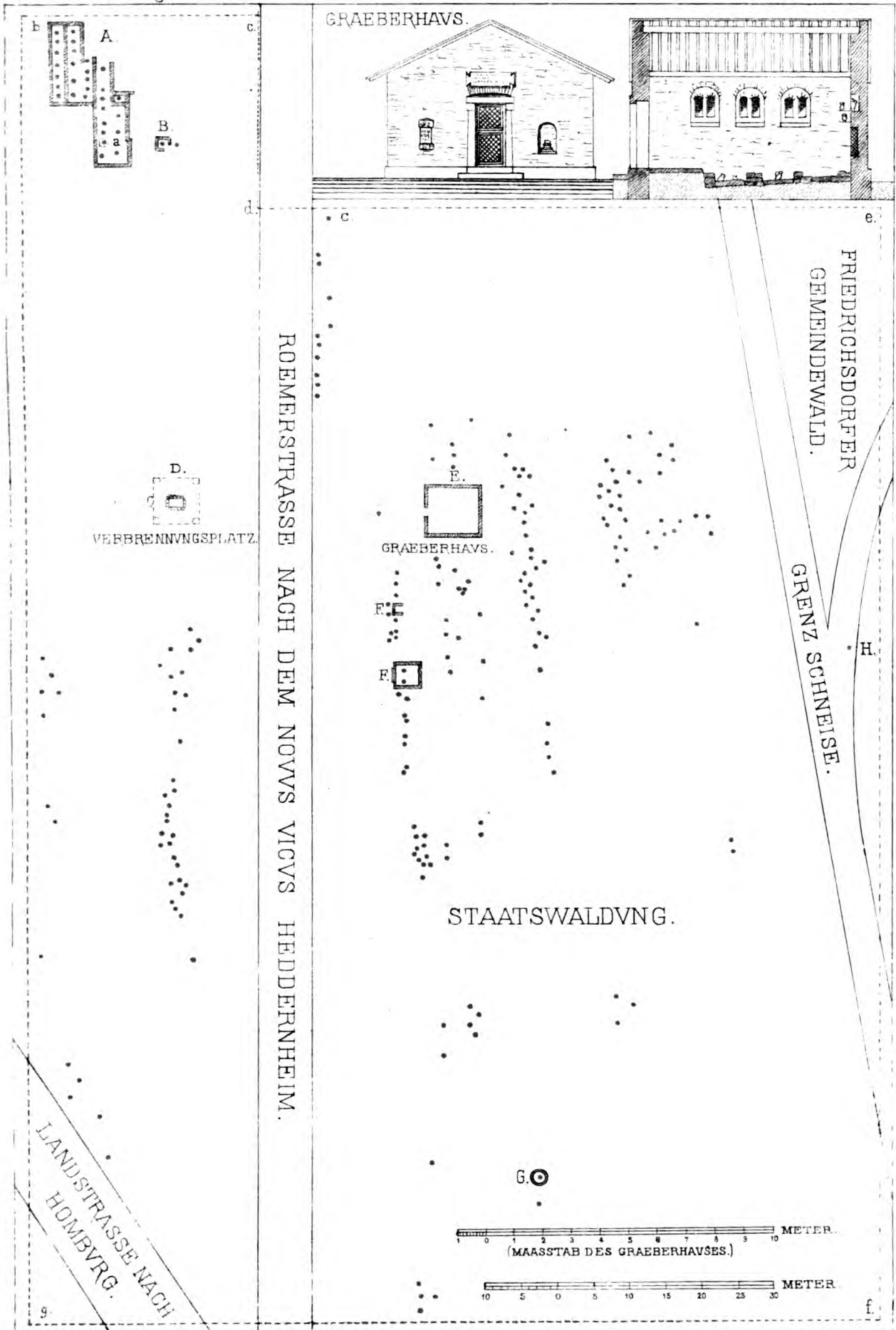
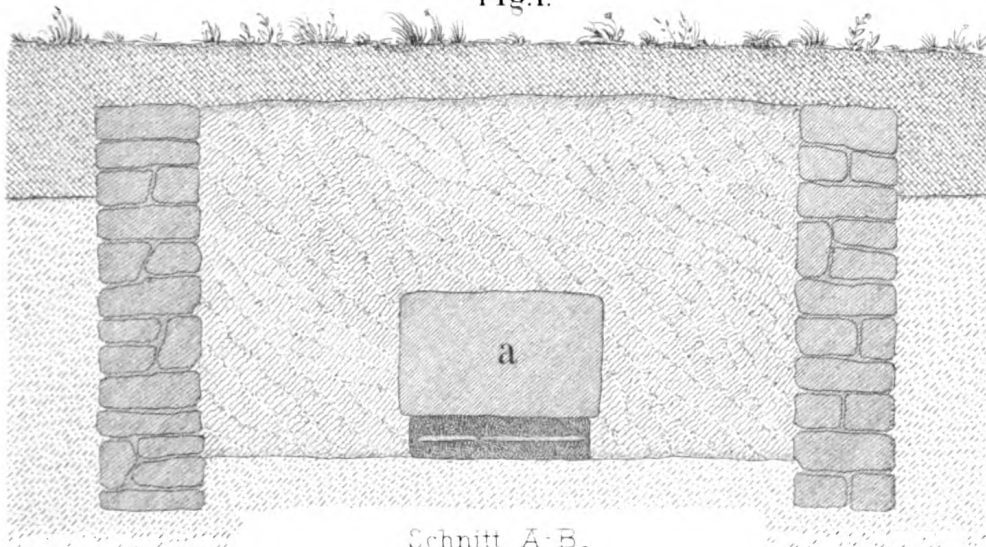



Fig. I.



Schnitt A-B.

Fig. II.

Grundriss.

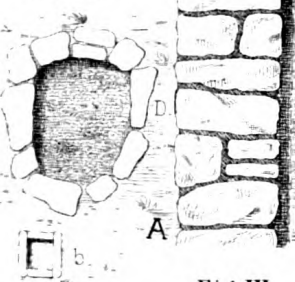

Fig. IIa.

Schnitt C-D.

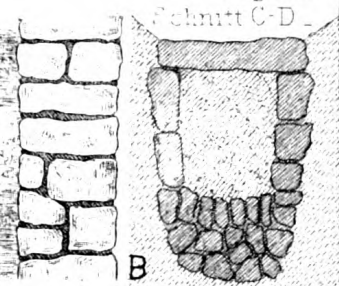

Fig. III.

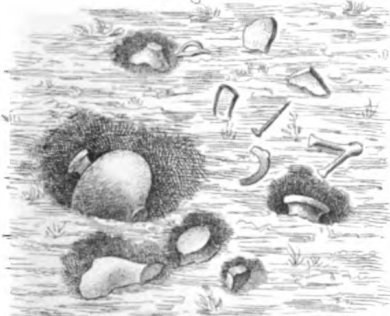

Fig. IV.



Fig. V.



Fig. VII.



Fig. VI.

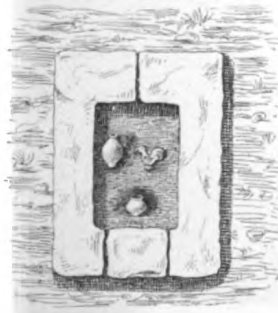
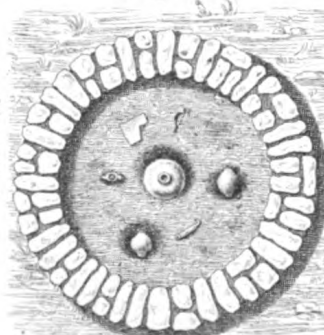
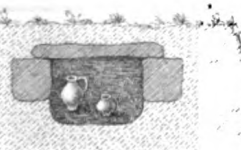

Fig. VIII.



E



F

Fig. I-7. Ma. der nat. Größe.

Schnitt E-F.

Fig. 8. Ma. der nat. Größe.

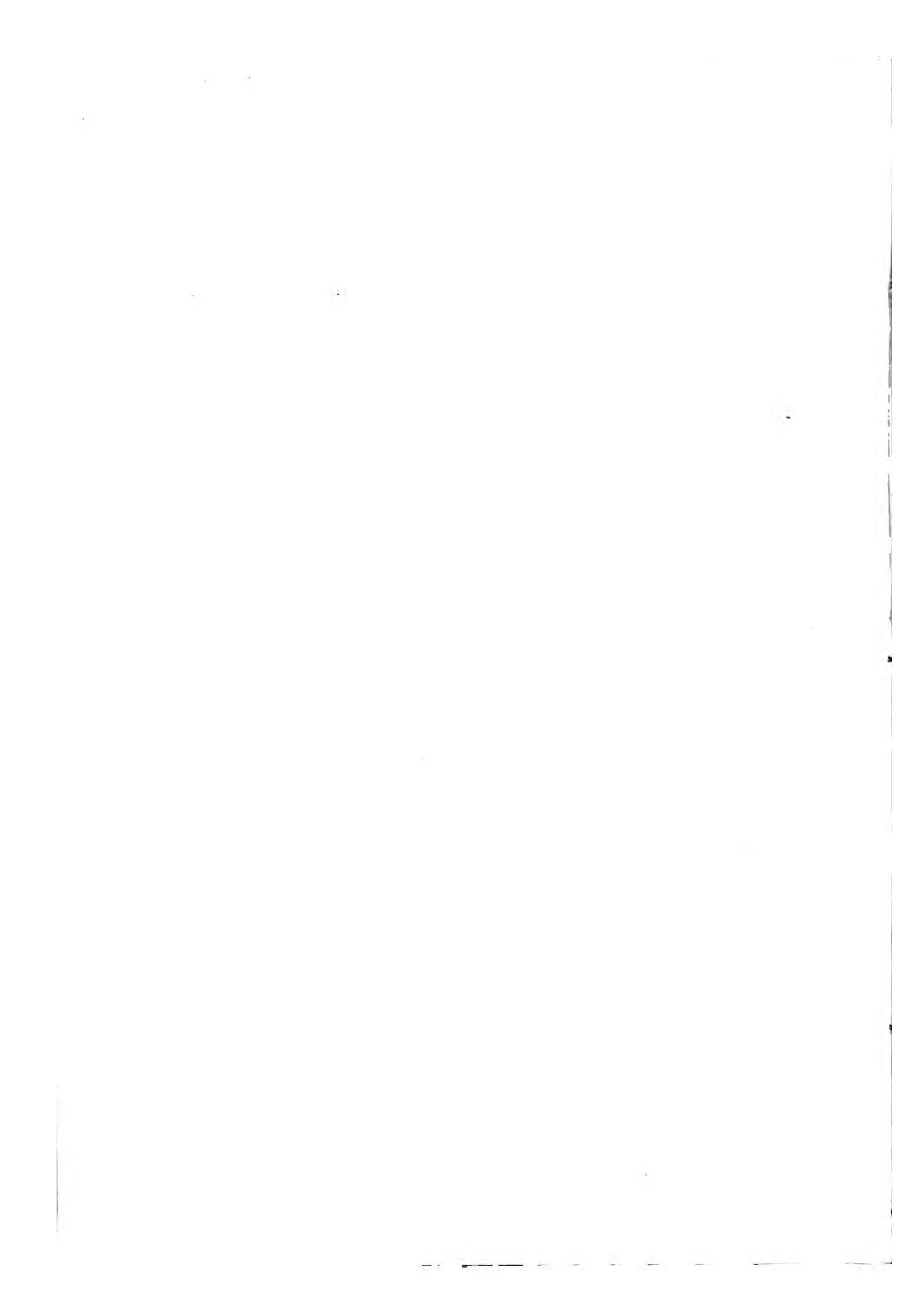



Ein Zehntel d. nat. Gröfse.

Saalburg-Museum, Homburg v. d. H.

A. Pauli, Lith. Anst. d. Saalburg





BILDWERKE

Die Saalburg.

Stein

TAFEL XXV.

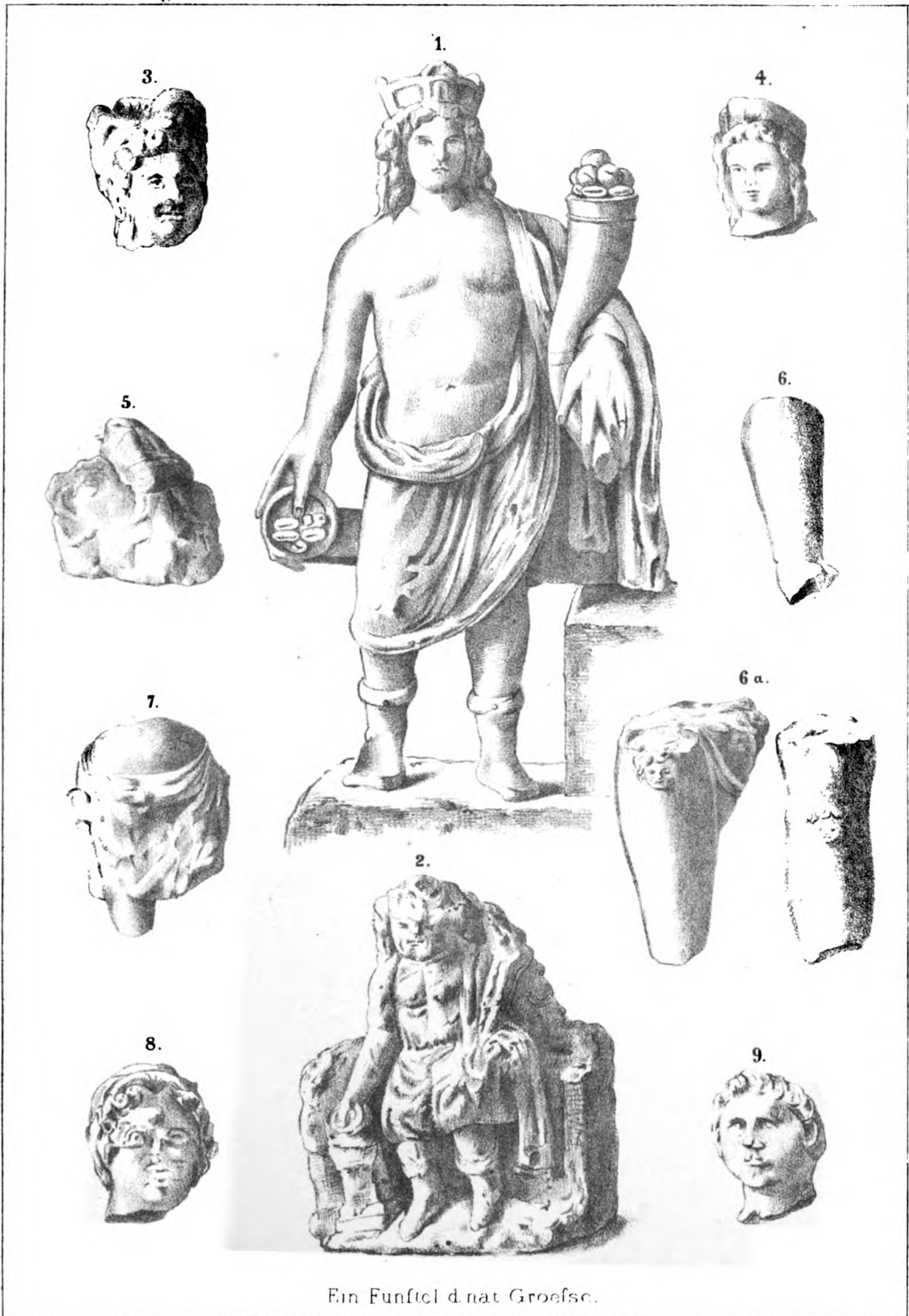

Ein Funftel d nat Groefse.

Saalburg-Museum, Homburg v. d. H.

\_\_\_\_\_

\_\_\_\_\_



Ein Fünftel d. nat. Gröfse.

Saalburg-Museum, Homburg v.d.H.



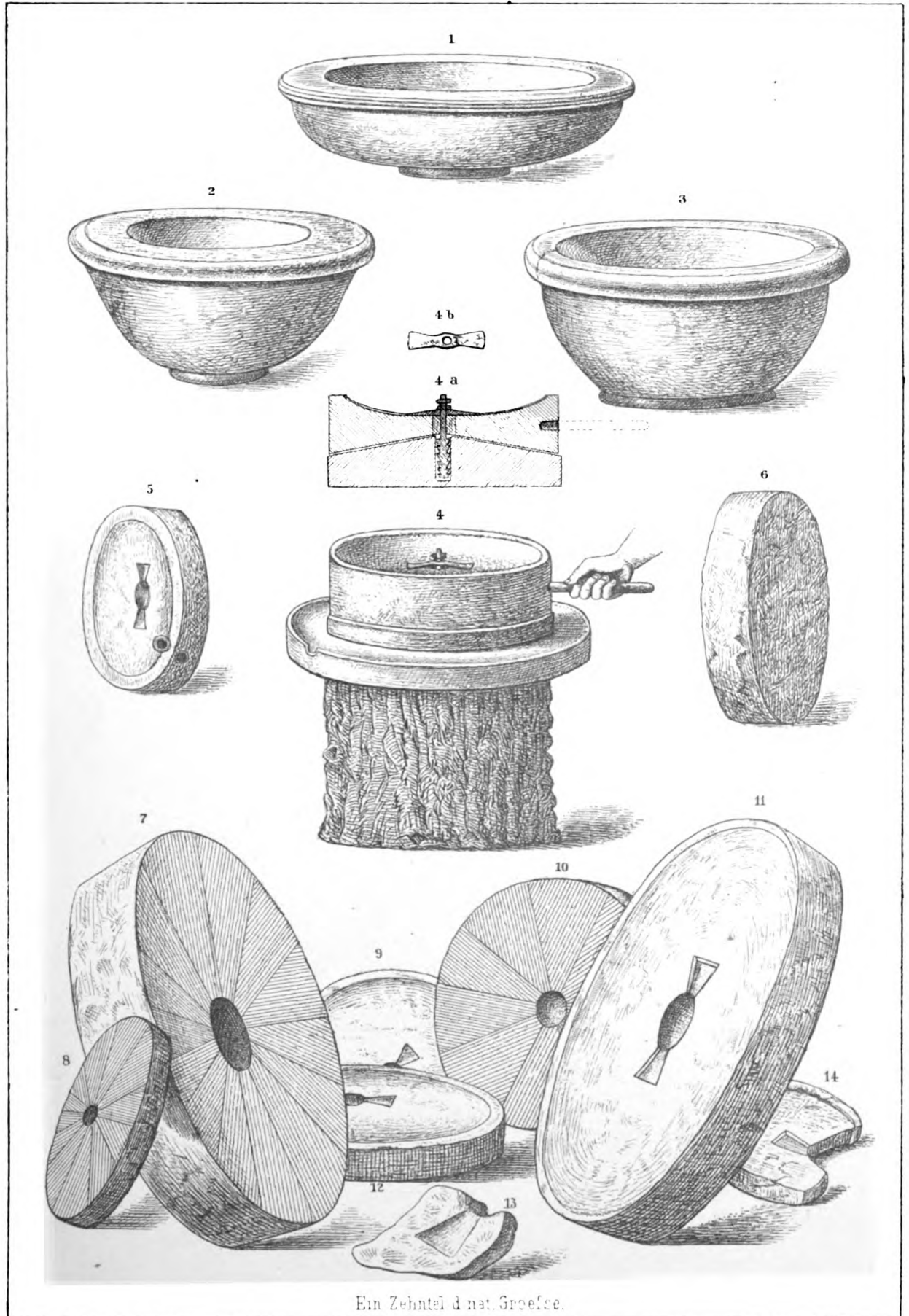

Ein Zehntel d. nat. Gröesse.

Saalburg-Museum, Homburg v. d. H.

A. Pauli Lith. Anst. Homburg

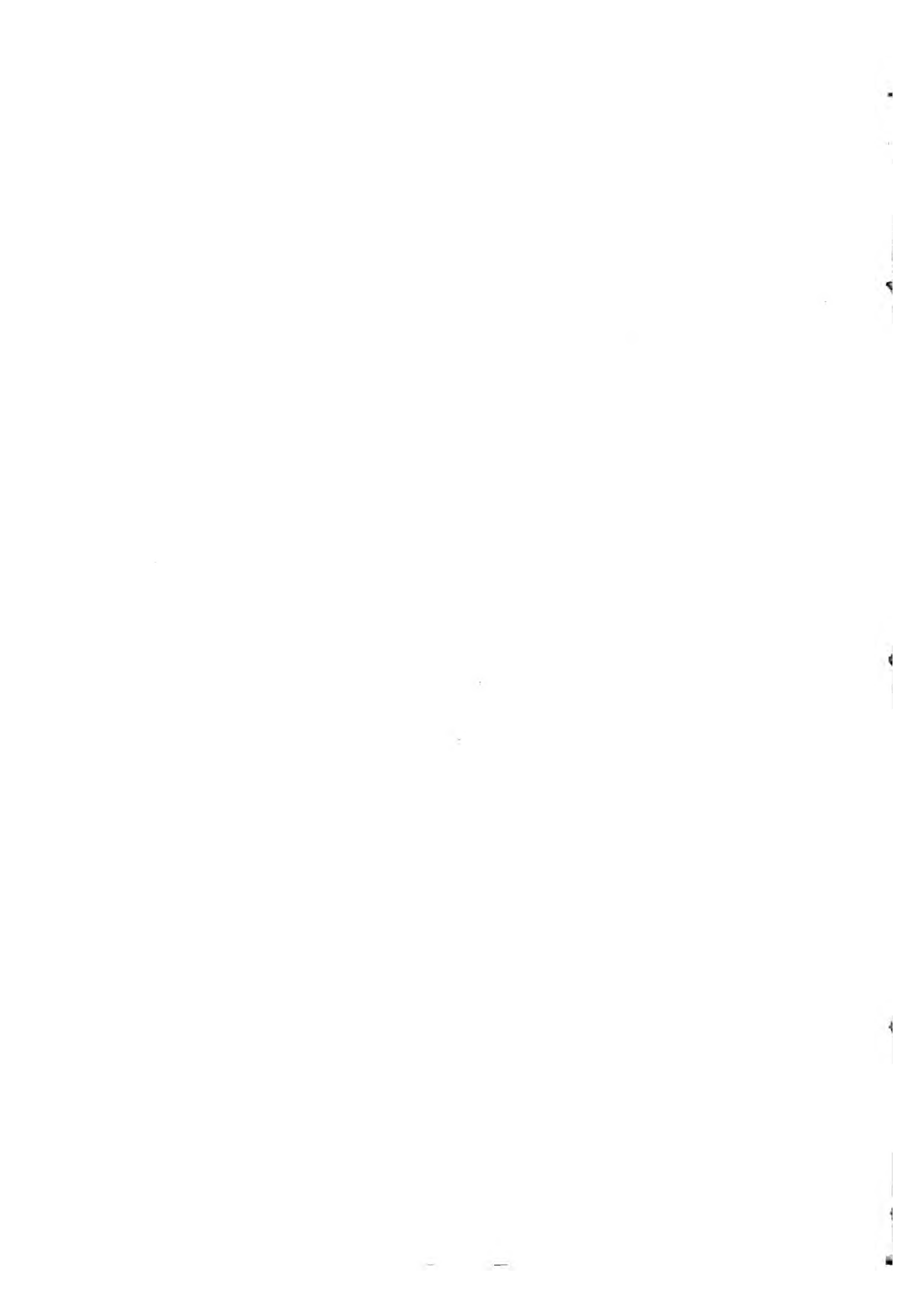

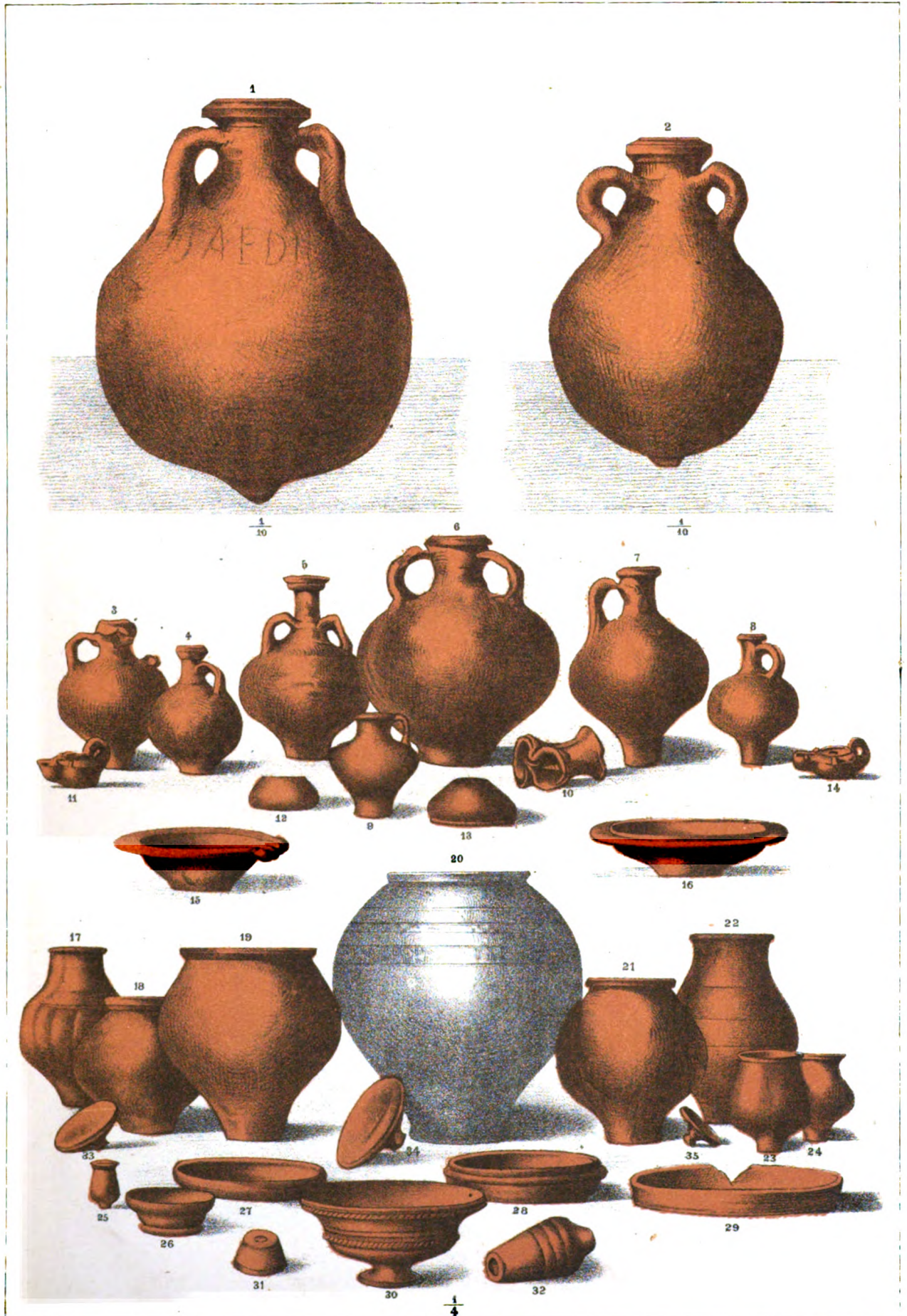

Saalburg-Museum, Homburg v.d.H.

A Pauli Lith. Anst. Homburg







Ein Fünftel d.nat.Groefse.

Saalburg-Museum, Homburg v. d. H.

A Pauli, Lith. Anst, Homburg



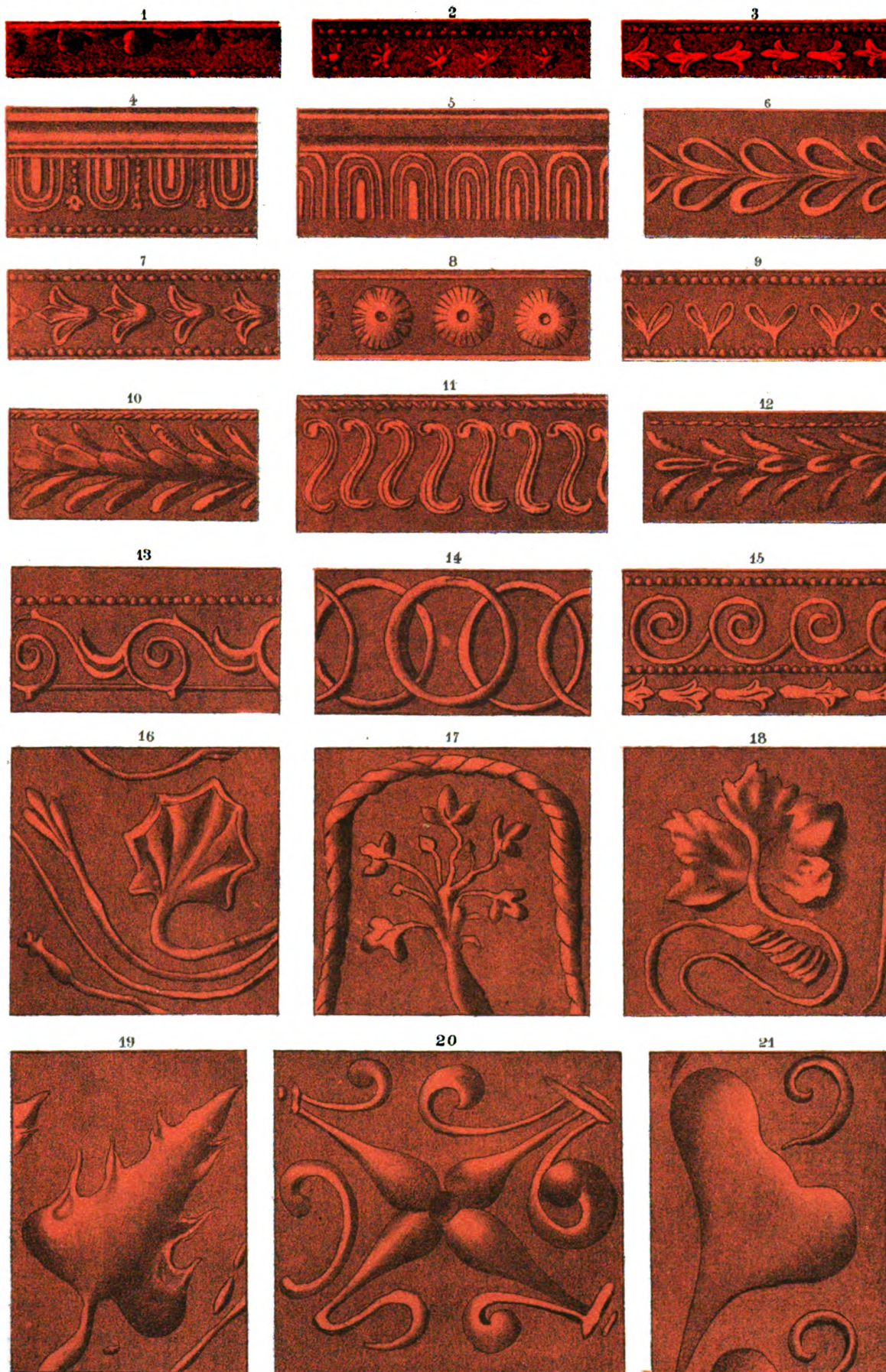

Natürliche Gröesse.

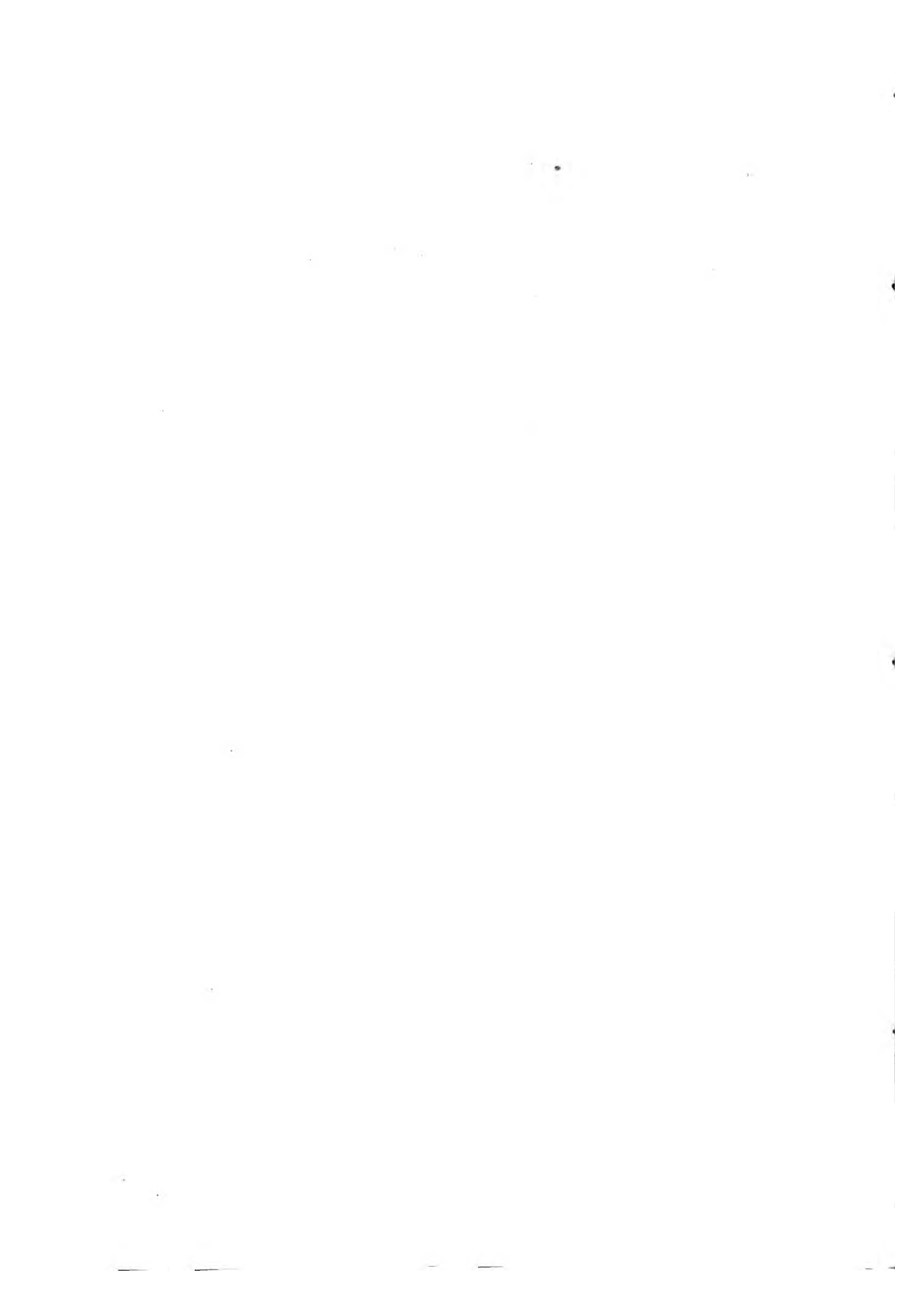

BILDLICHE DARSTELLUNGEN.

Die Saalburg.

auf Terra sigillata Gefässen.

TAFELXXXI.

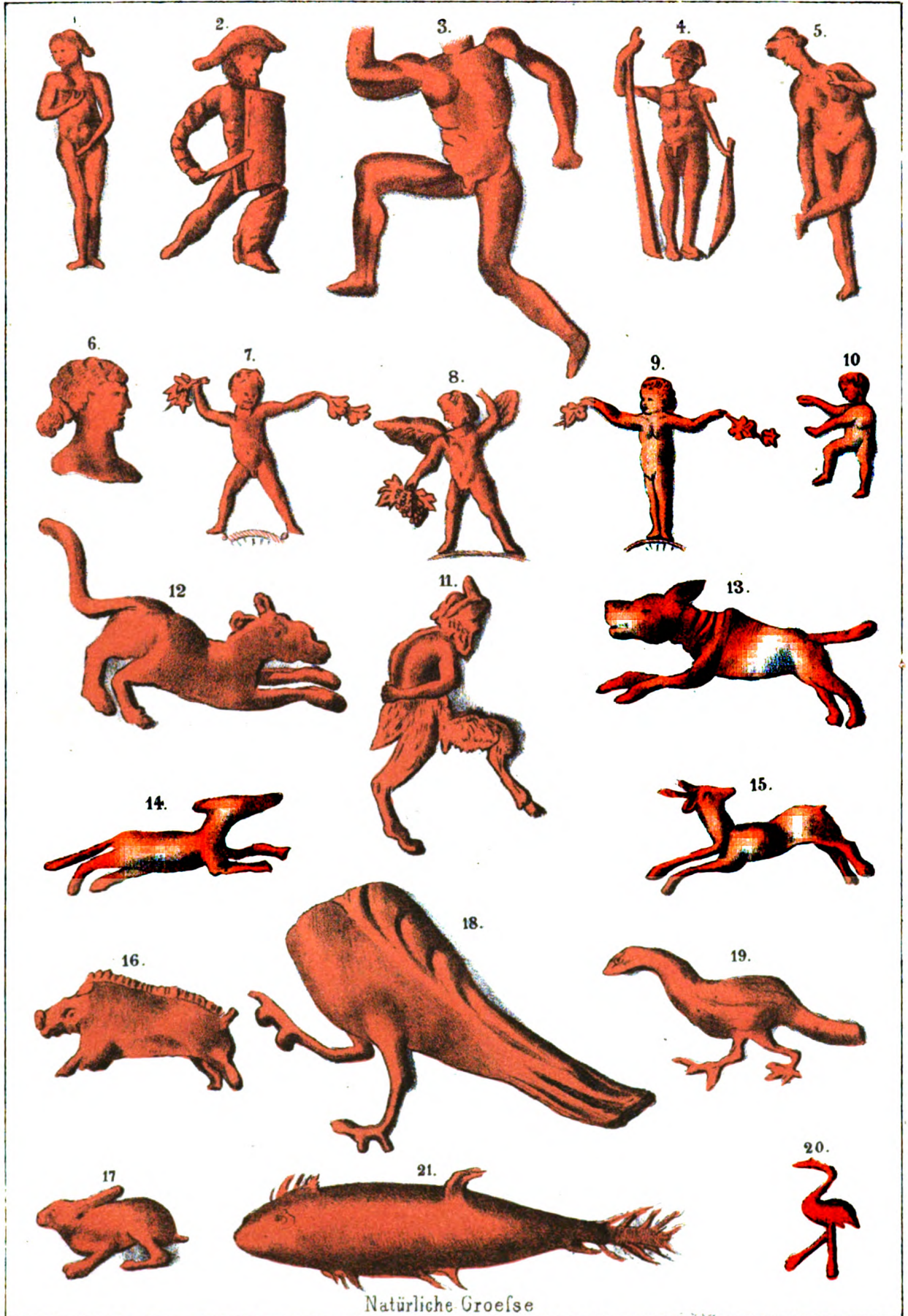

Natürliche Gröesse

Saalburg-Museum, Homburg v. d. H.

A. Pauli Lith. Anst. Homburg.

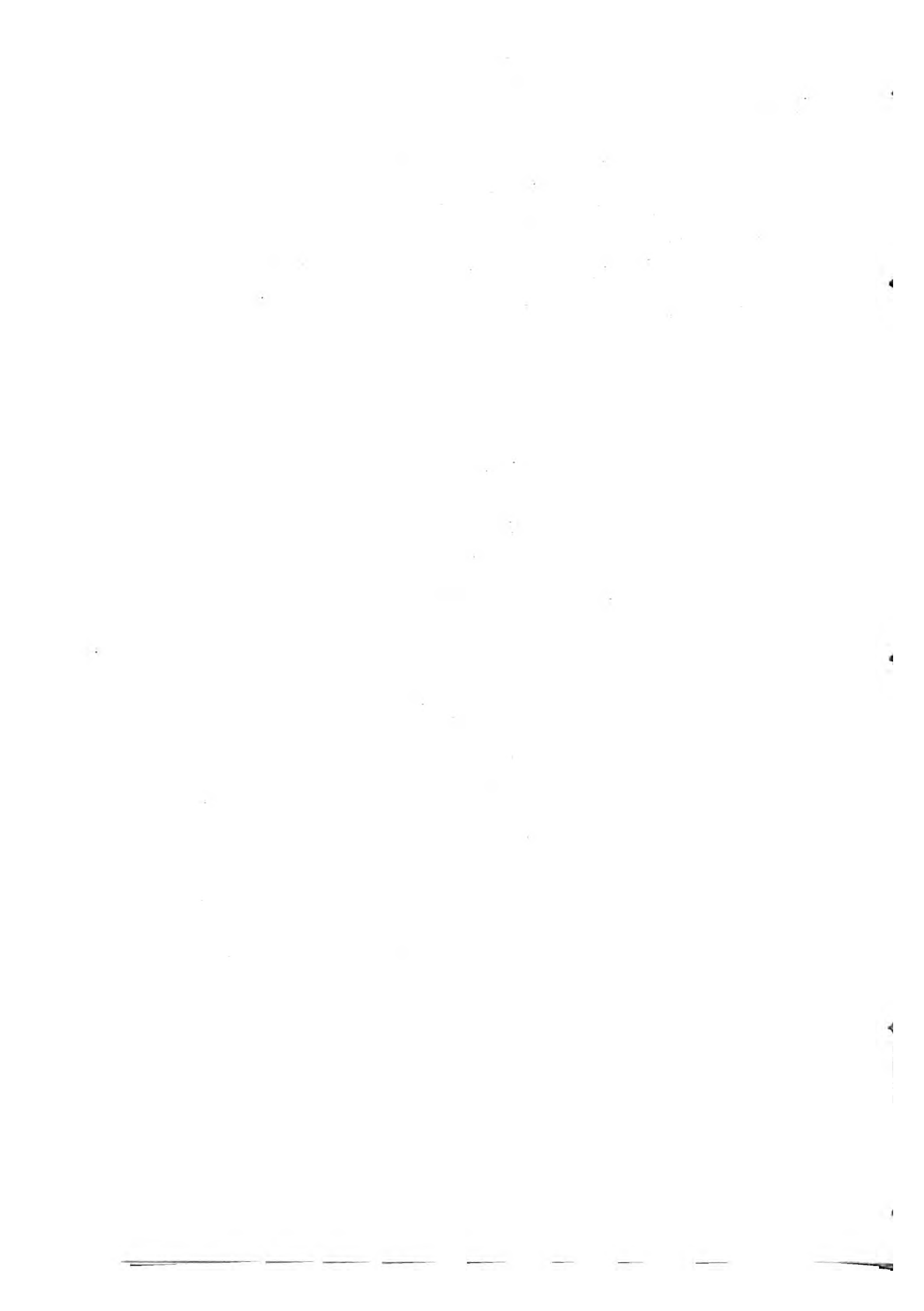

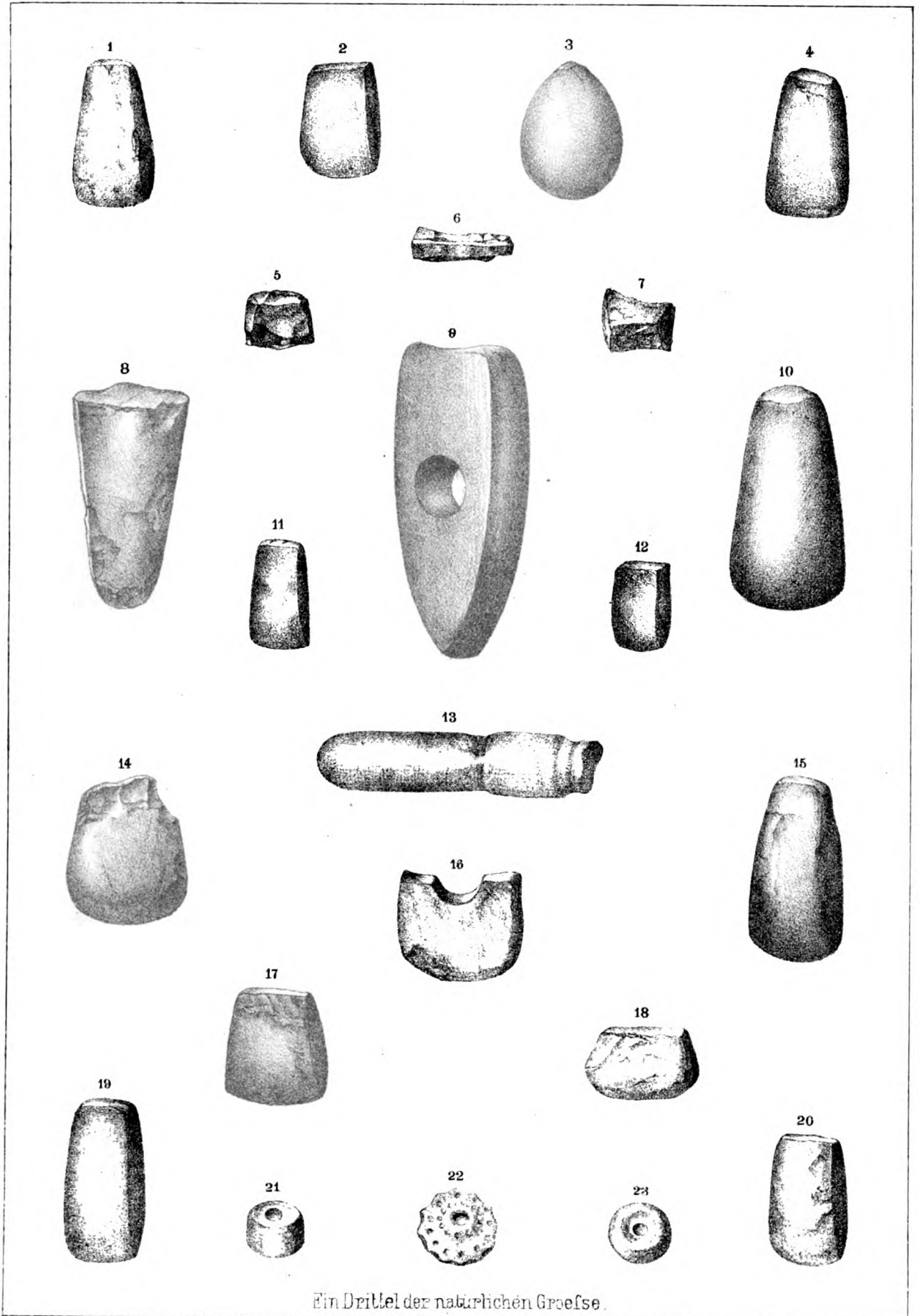

Ein Drittel der natürlichen Gröefse.





WERKZEUGE.

Eisen.

TAFEL XXXIII.

Die Saalburg.

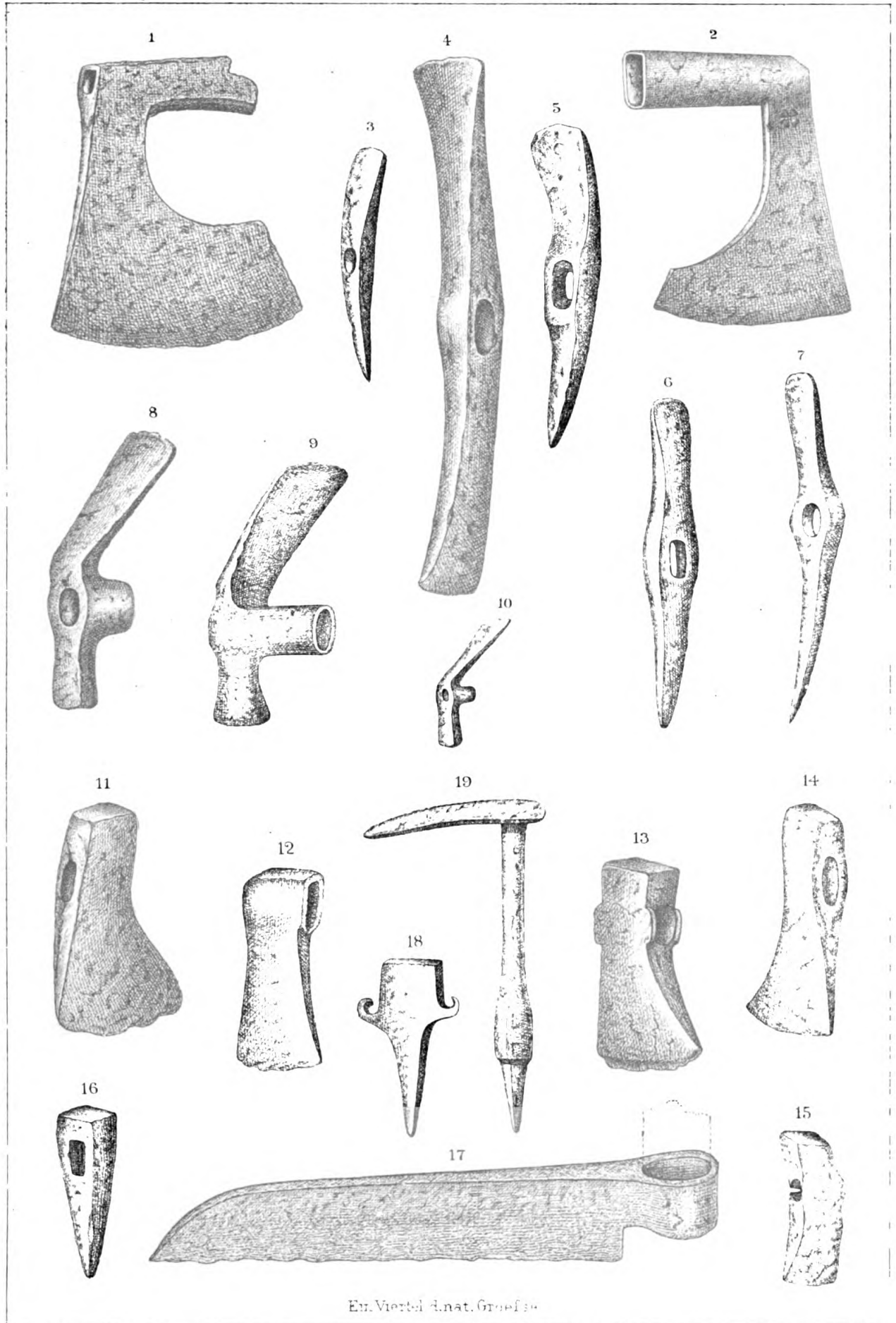

Ein Viertel d. nat. Größe

Saalburg-Museum, Homburg v. d. H.

A. Fournier, Kunst. Homburg.

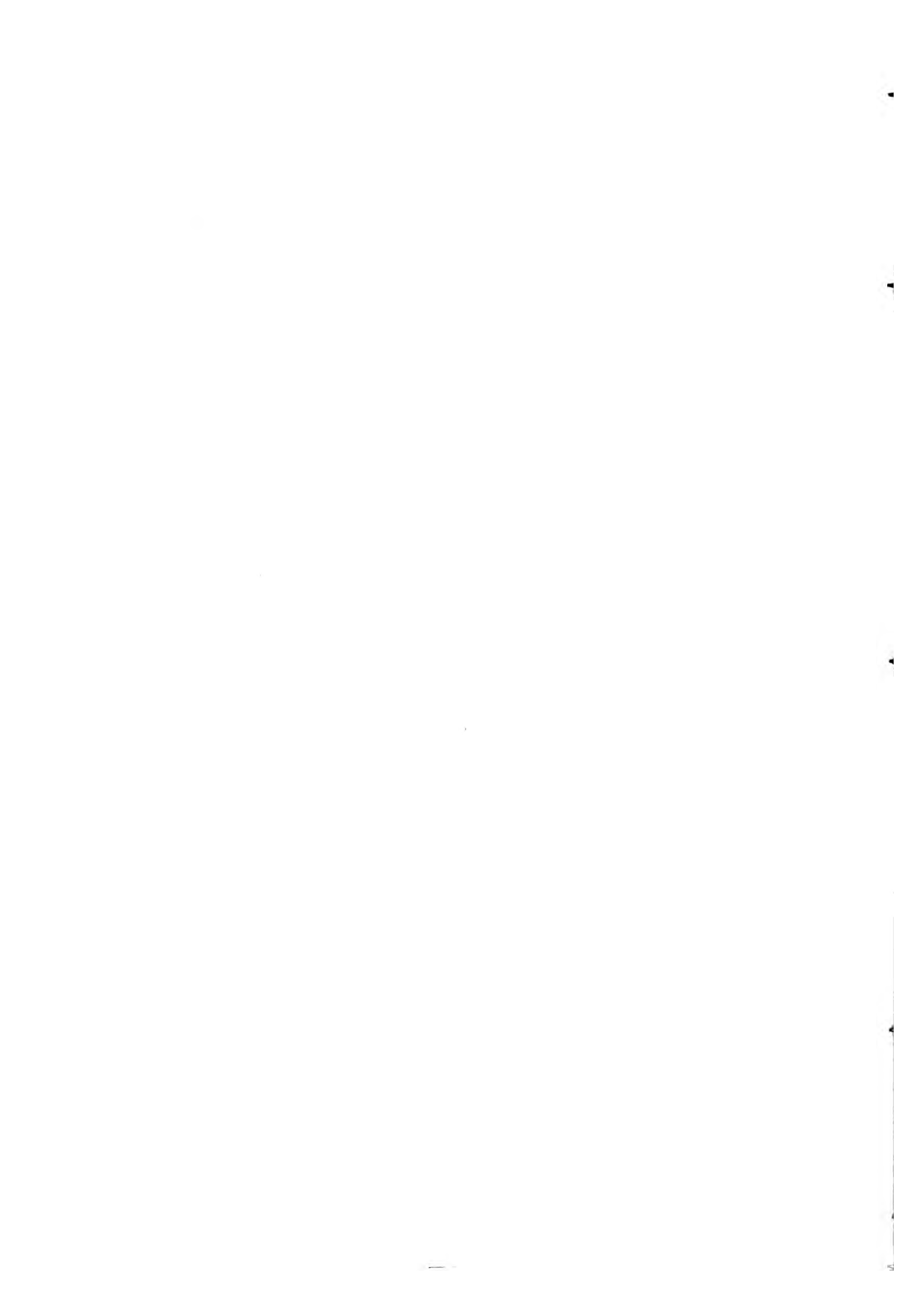

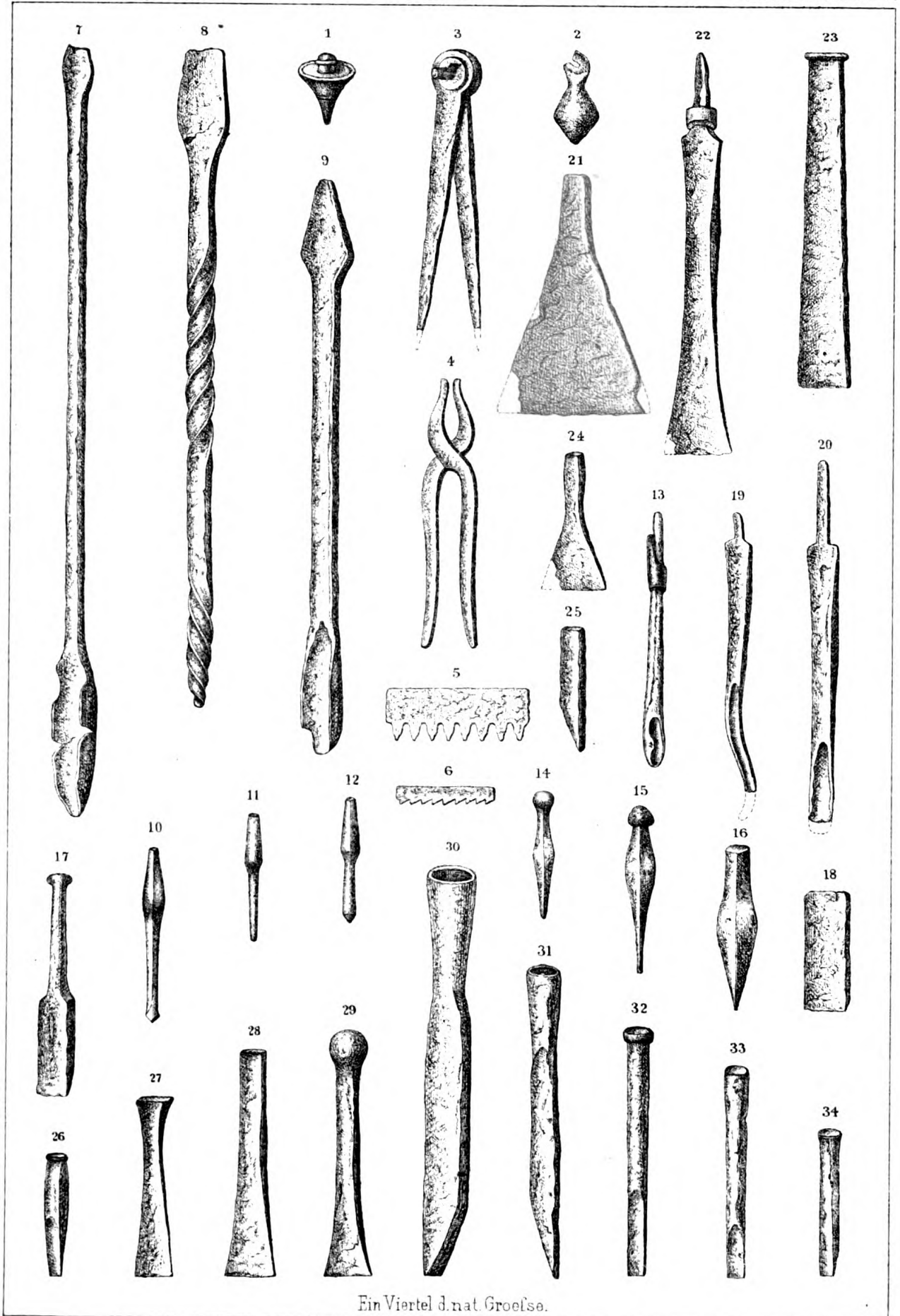

Ein Viertel d. nat. Gröfse.



# GERÄTHE UND WERKZEUGE.

Die Saalburg.

Eisen.

TAFEL XXXVI

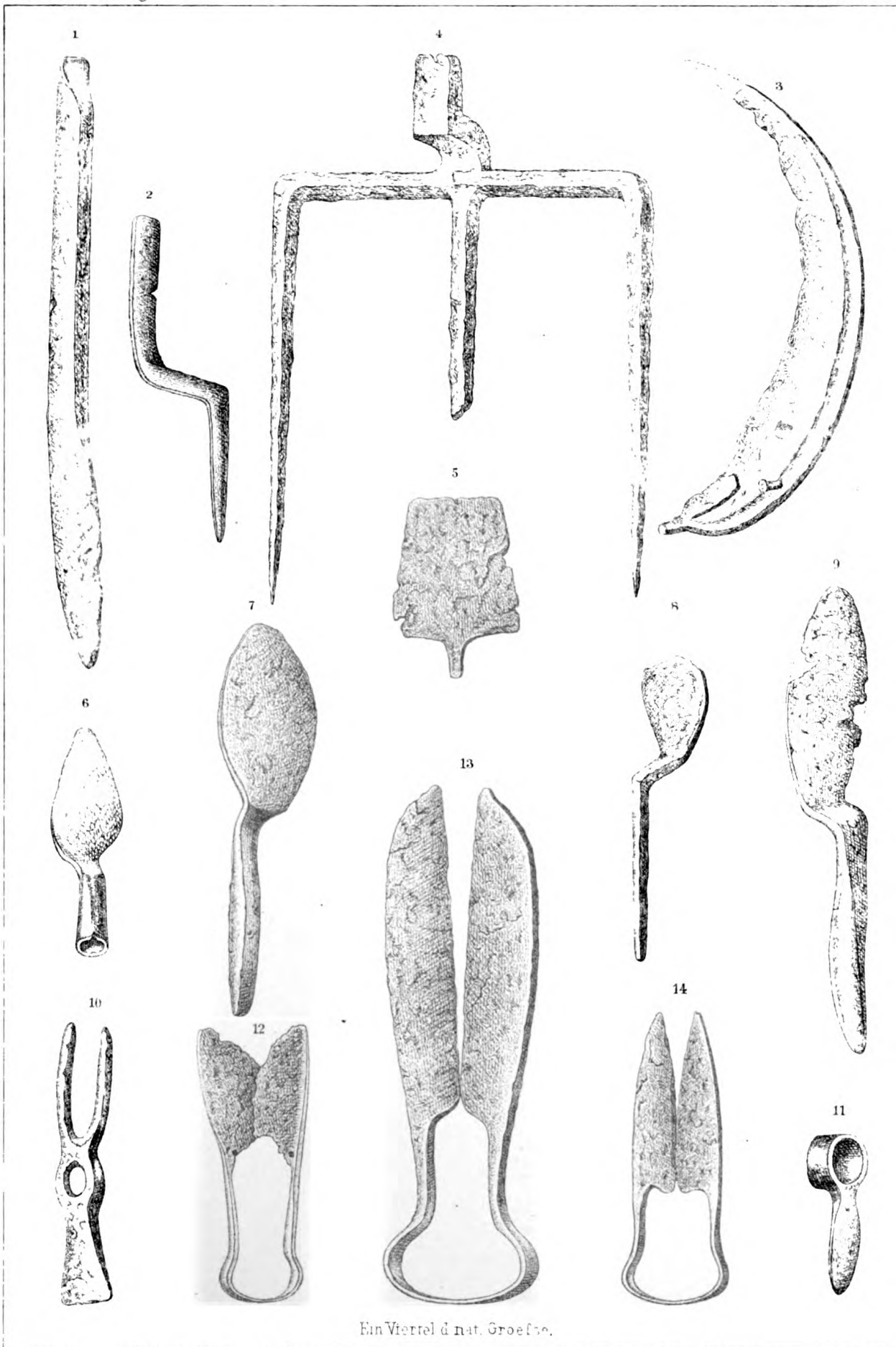

Ein Viertel d nat. Gröfse.

Saalburg-Museum, Homburg v.d H.

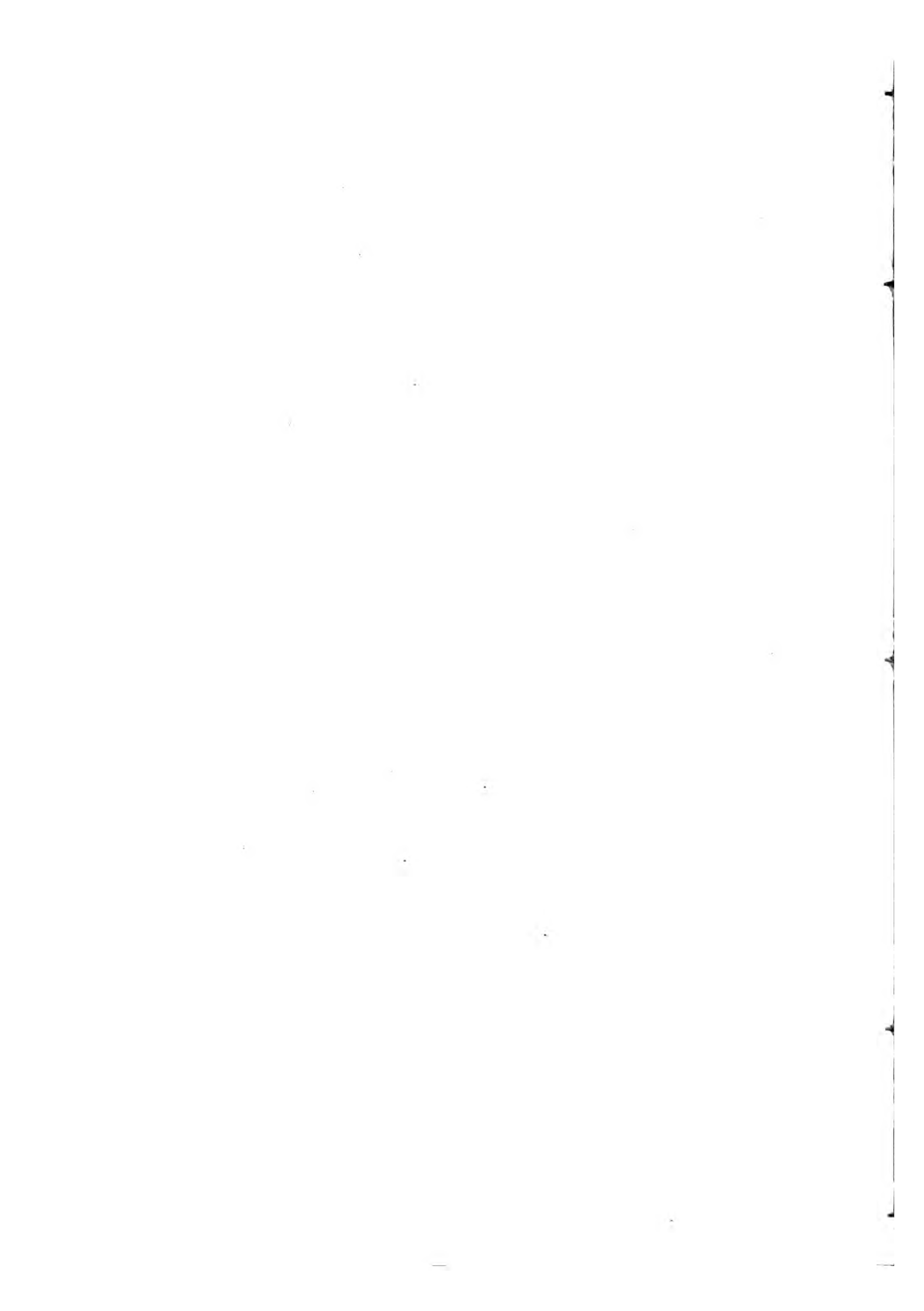

# SCHELLEN, SCHNALLEN & GERÄTHE.

Die Saalburg.

Eisen.

TAFEL XXXVI.

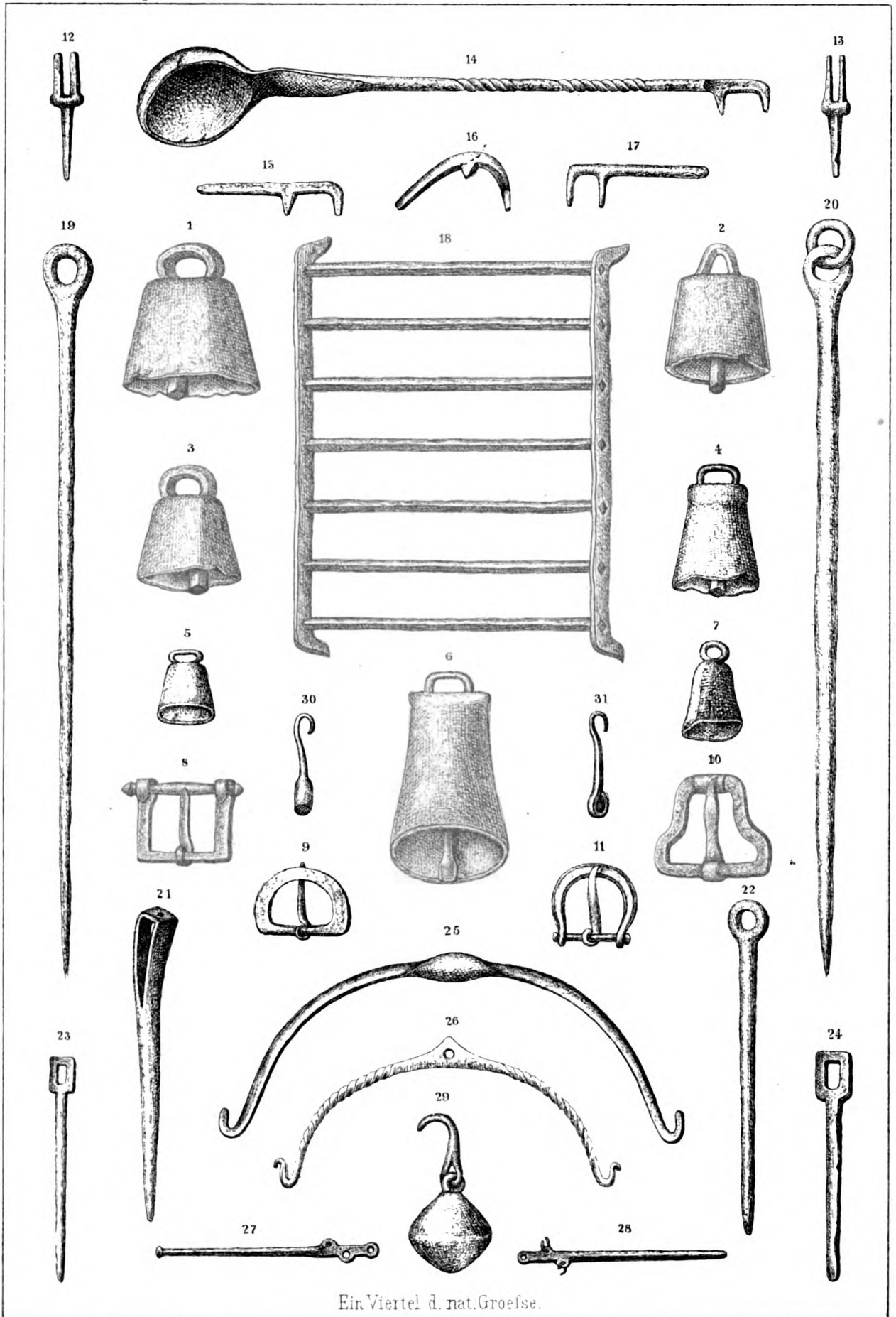

Ein Viertel d. nat. Gröfse.

Saalburg-Museum, Homburg v.d.H.

A. Pichler's Anst., Homburg





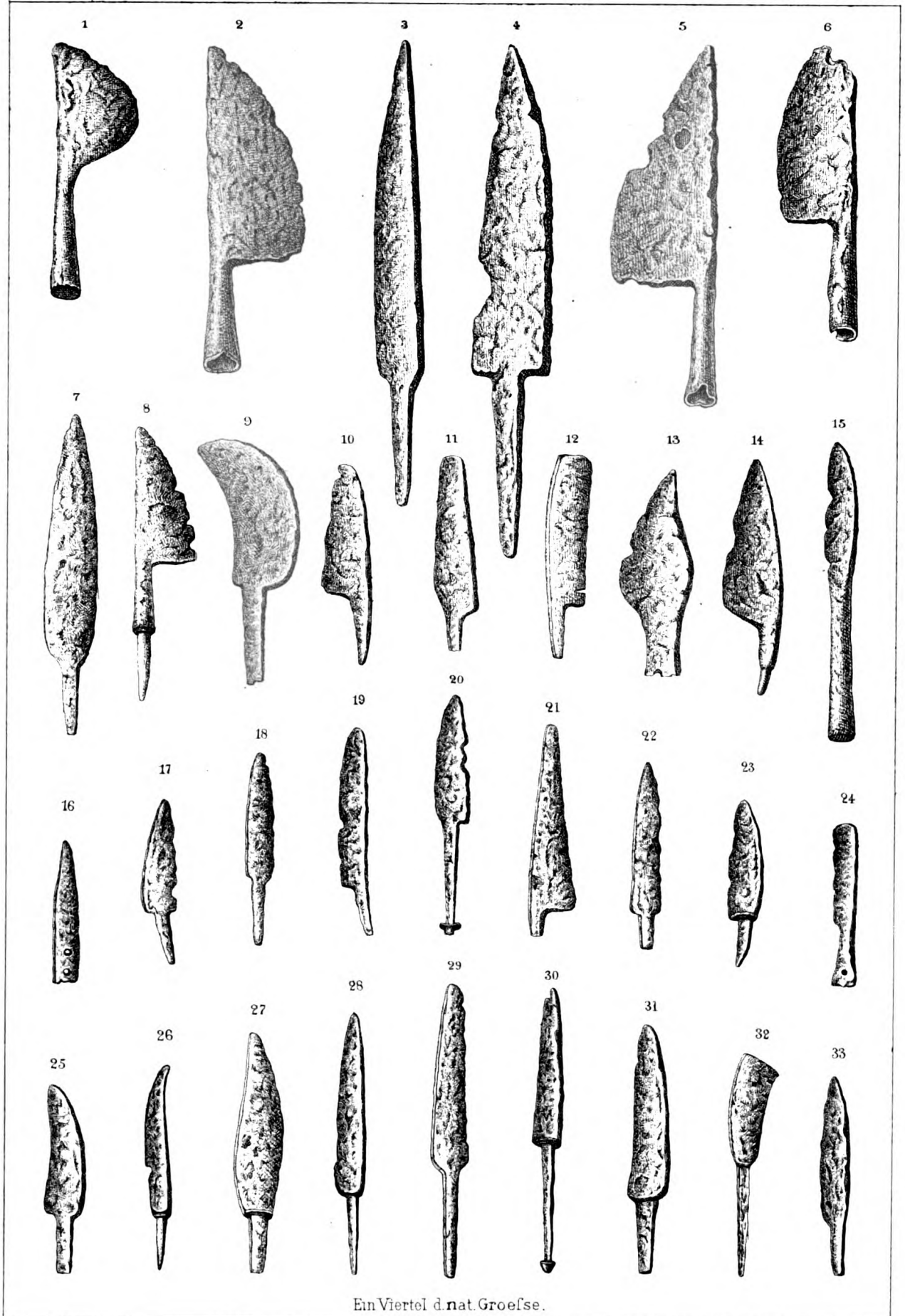

Ein Viertel d. nat. Groefse.

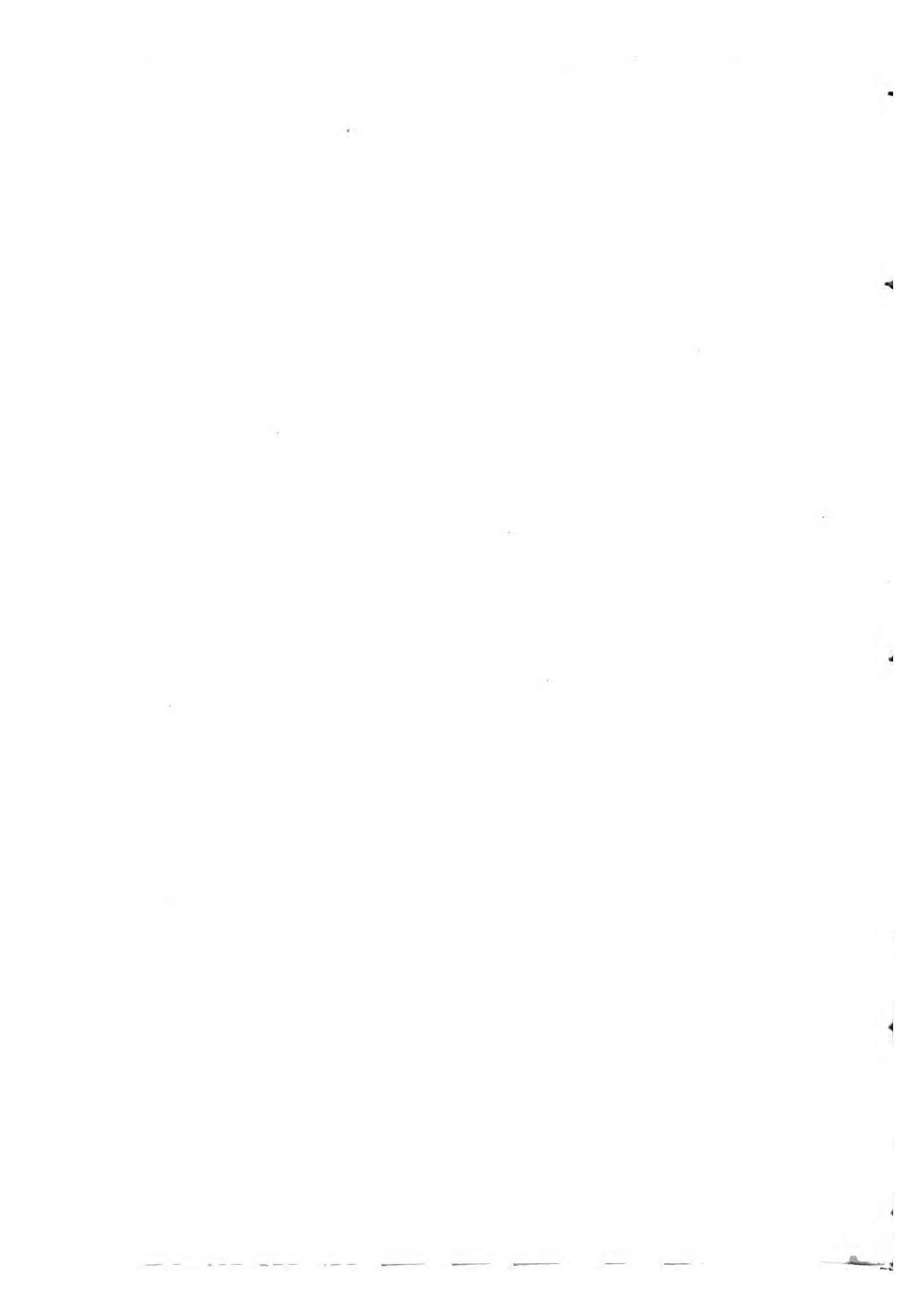

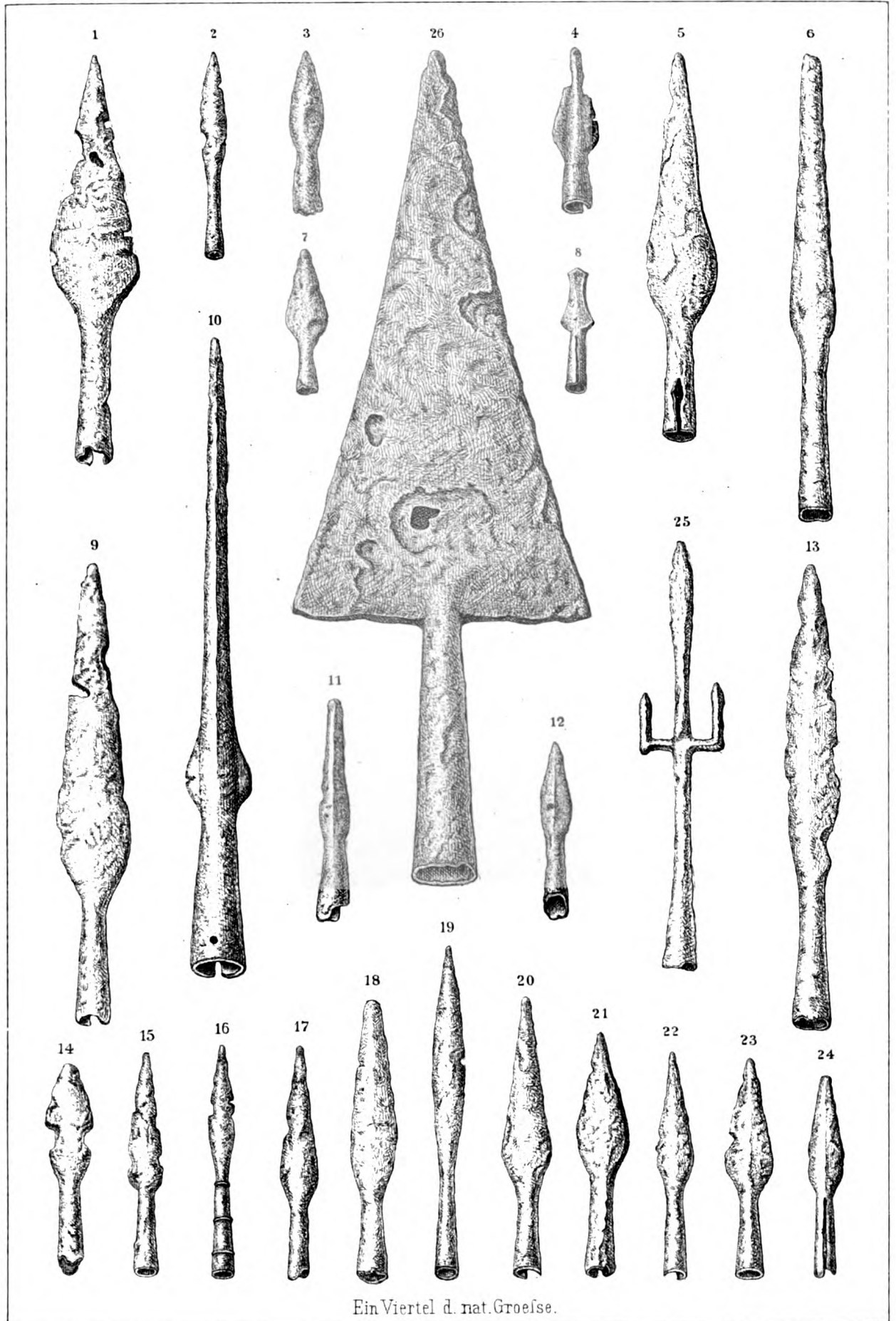

Ein Viertel d. nat. Gröesse.

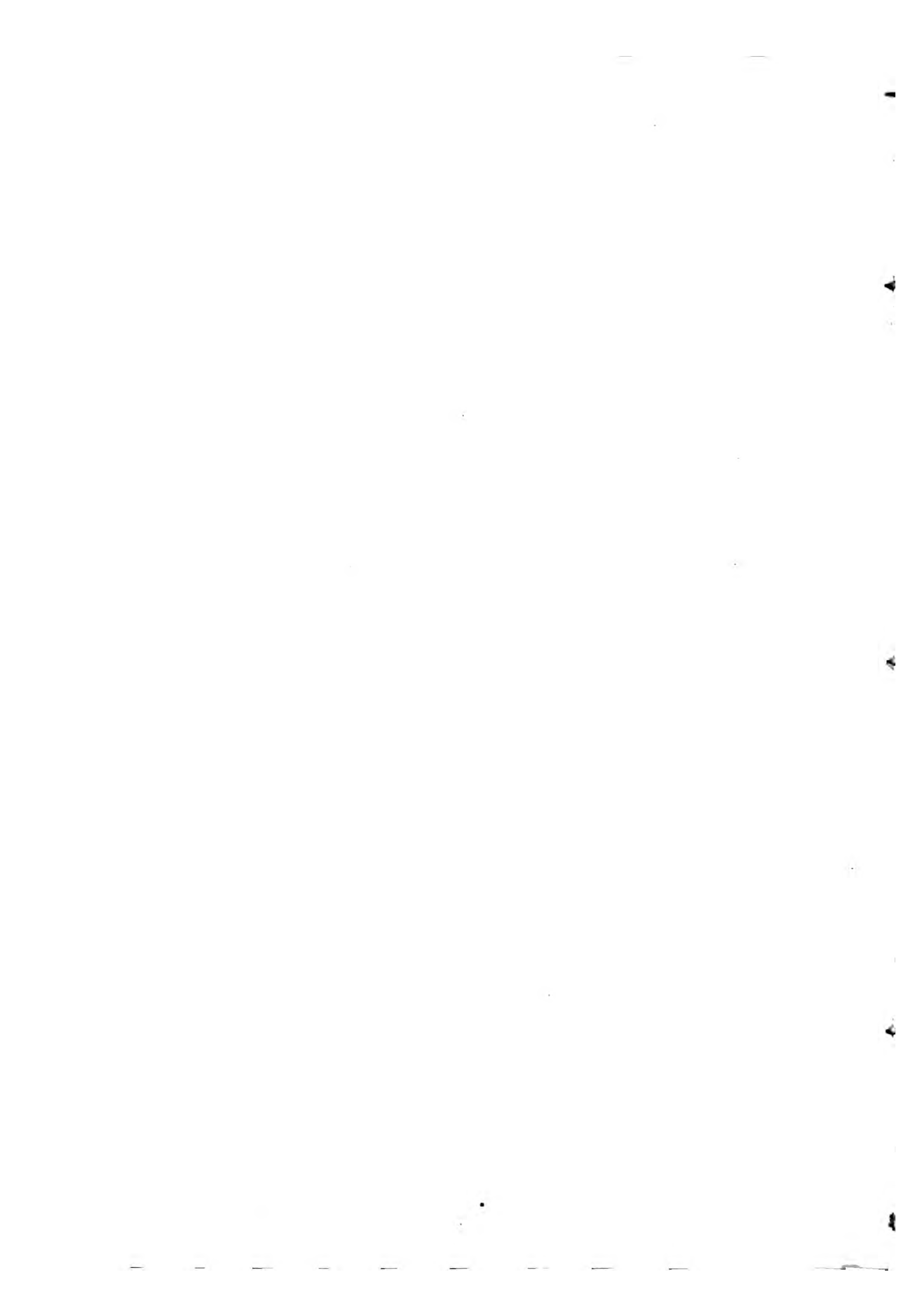

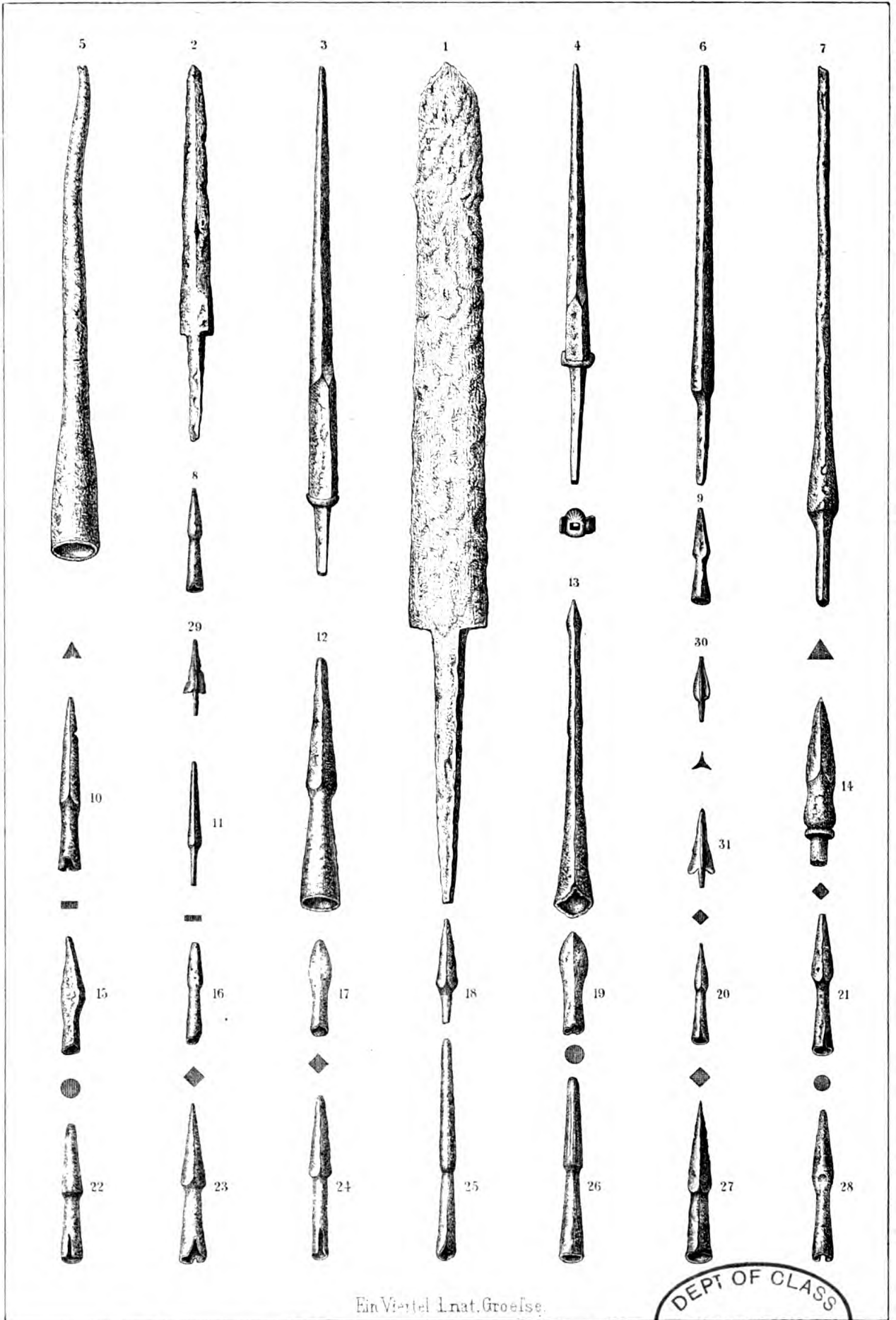

Ein Viertel Nat. Groesse.

Saalburg-Museum, Homburg v. d. H.

A. PAUL, Lit. Anst. Homburg



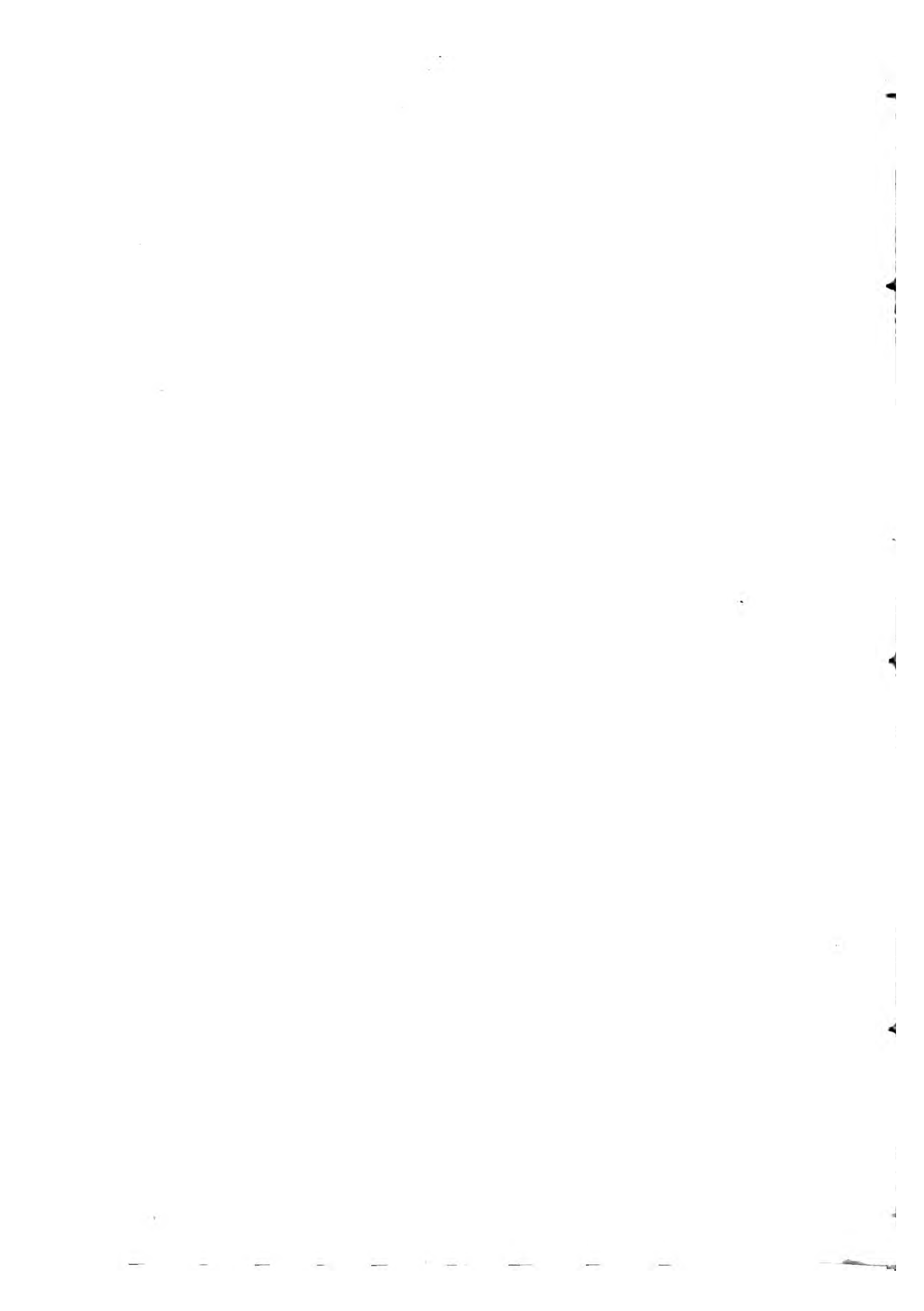

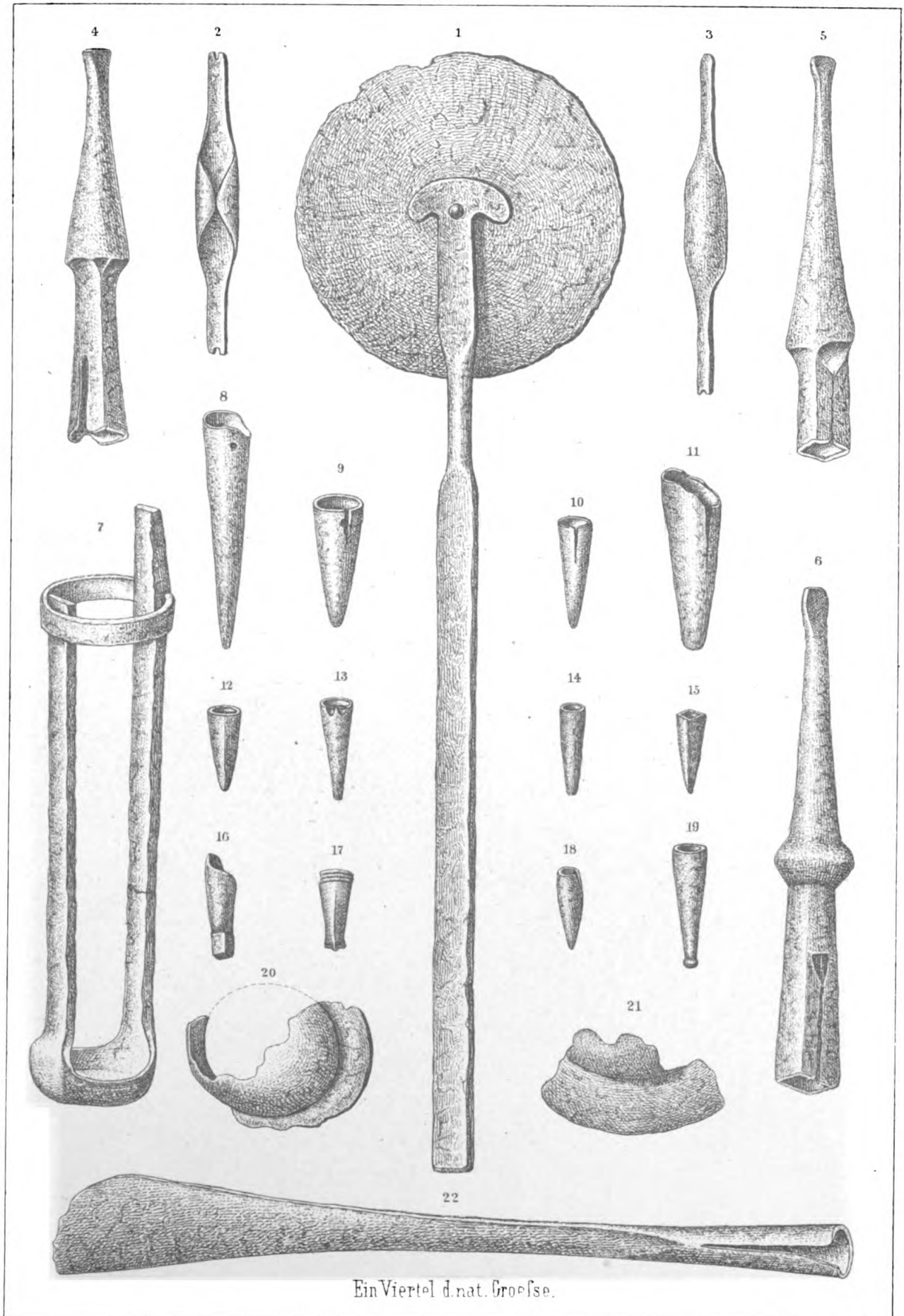

Ein Viertel d.nat. Gröfse.





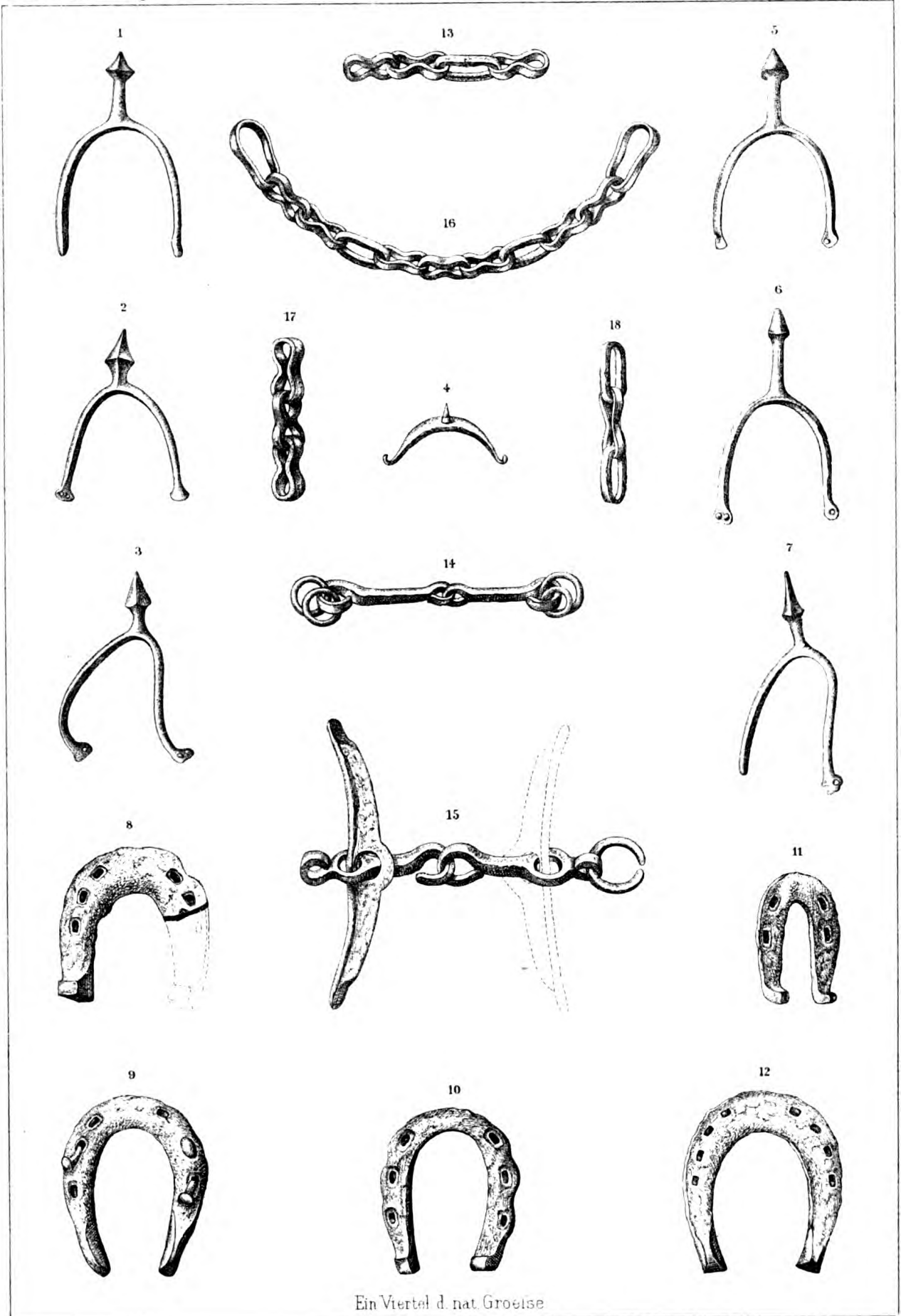

Ein Viertel d. nat. Gröesse



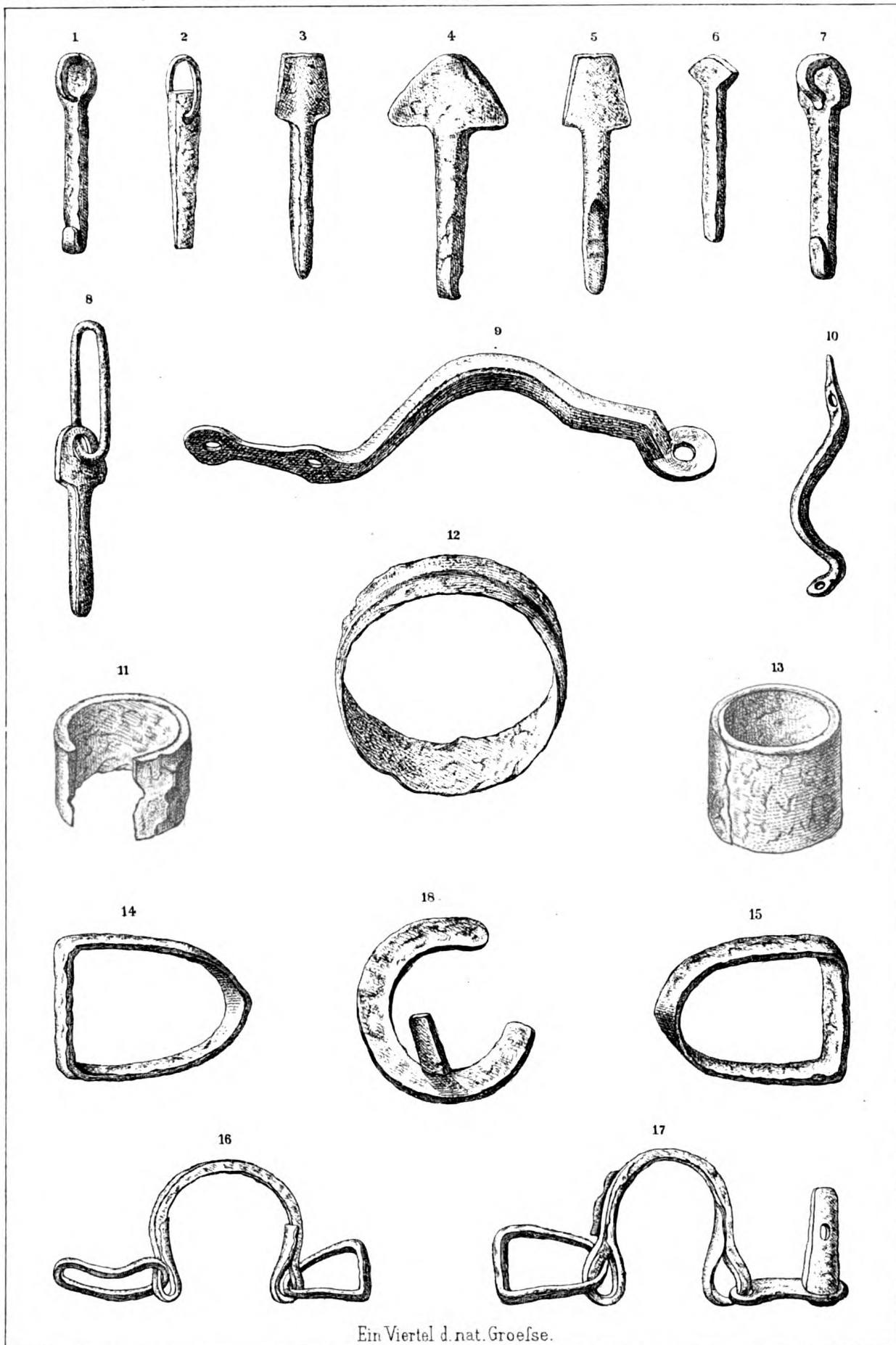

Ein Viertel d. nat. Groefse.



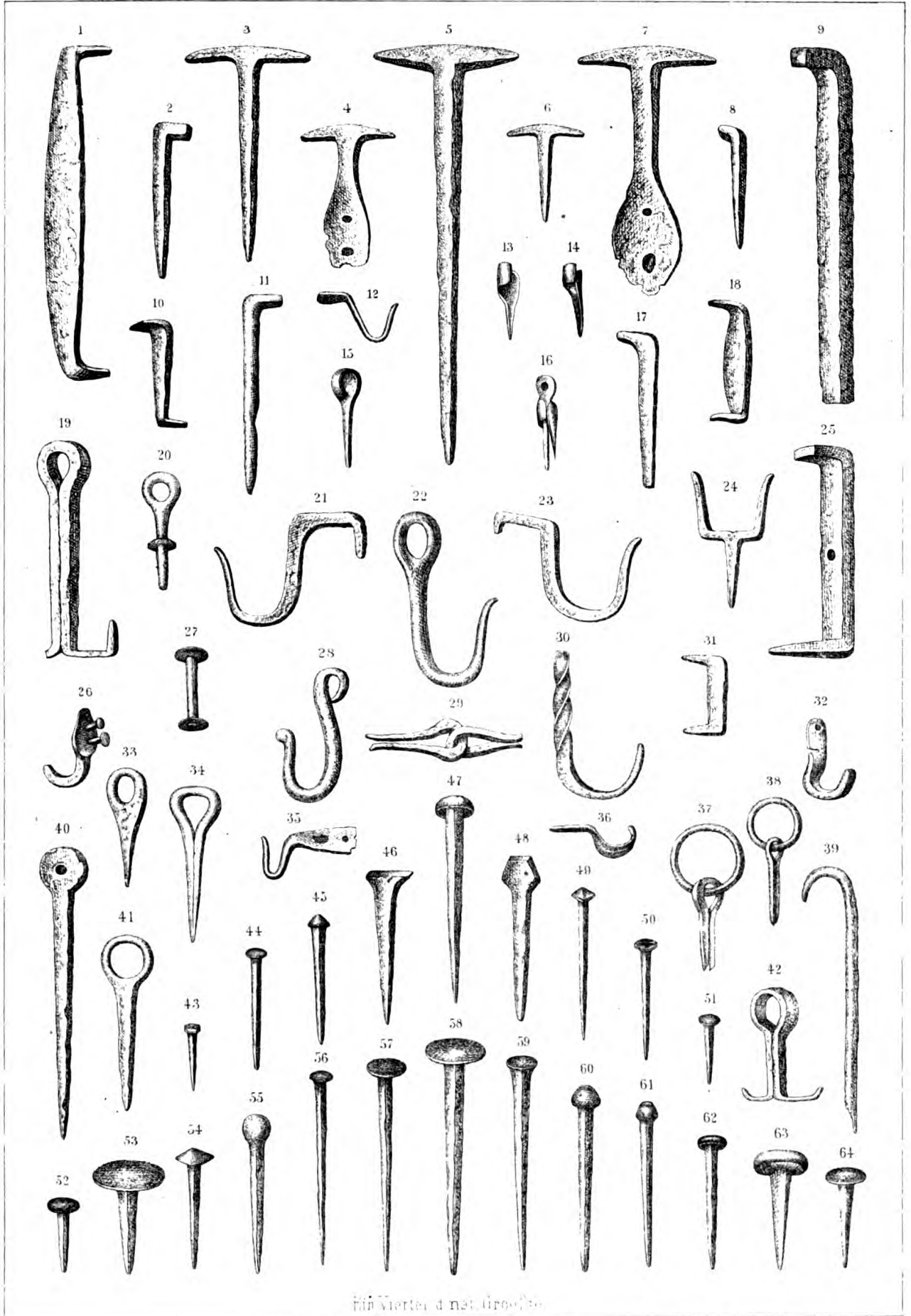

Ein Viertel d. nat. Größe



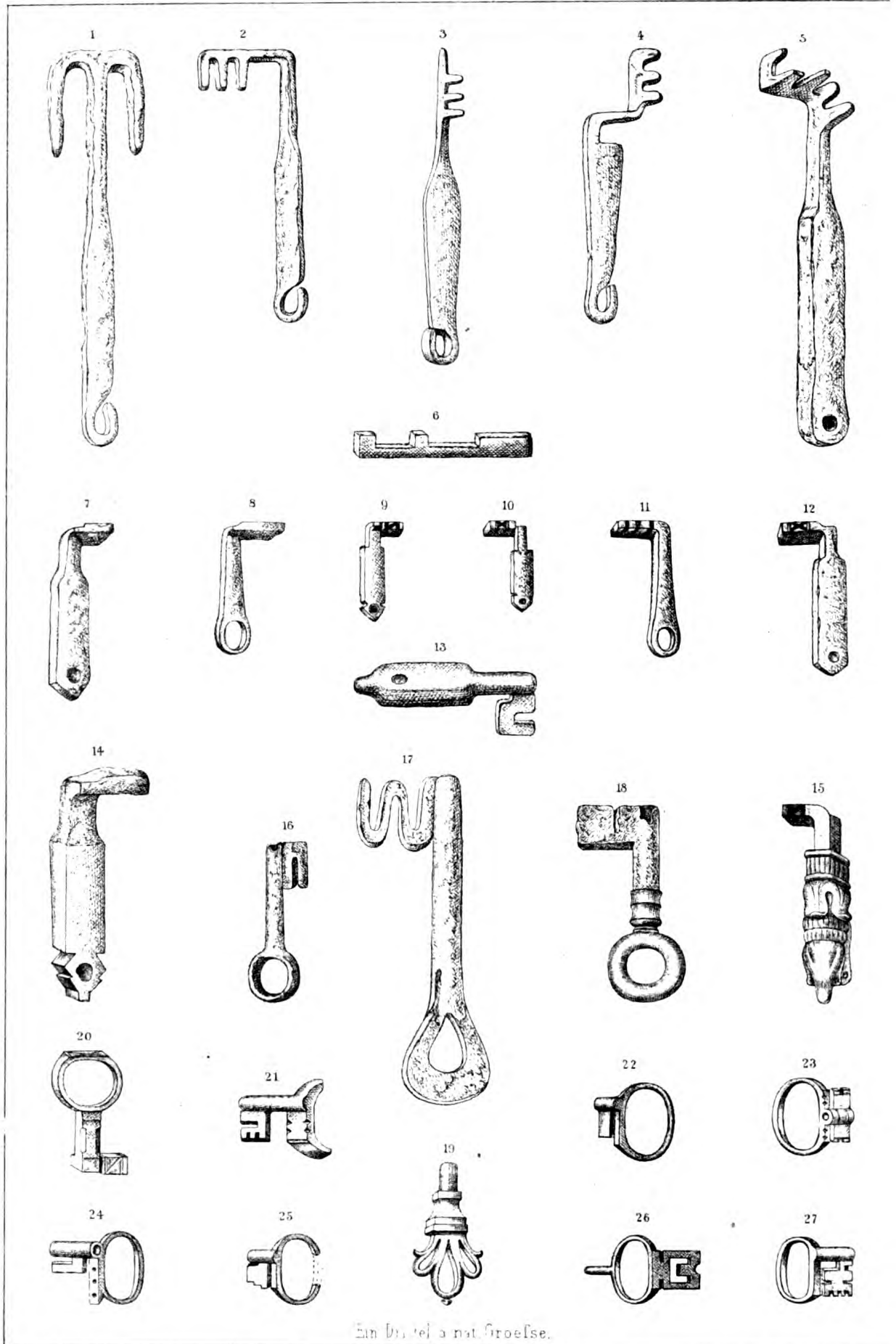

Ein Drittel a nat. Gröesse.





# SCHLOSSTHEILE & THÜRBECHLÄGE.

Die Saalburg.

Eisen und Bronze.

TAFEL XXXV.

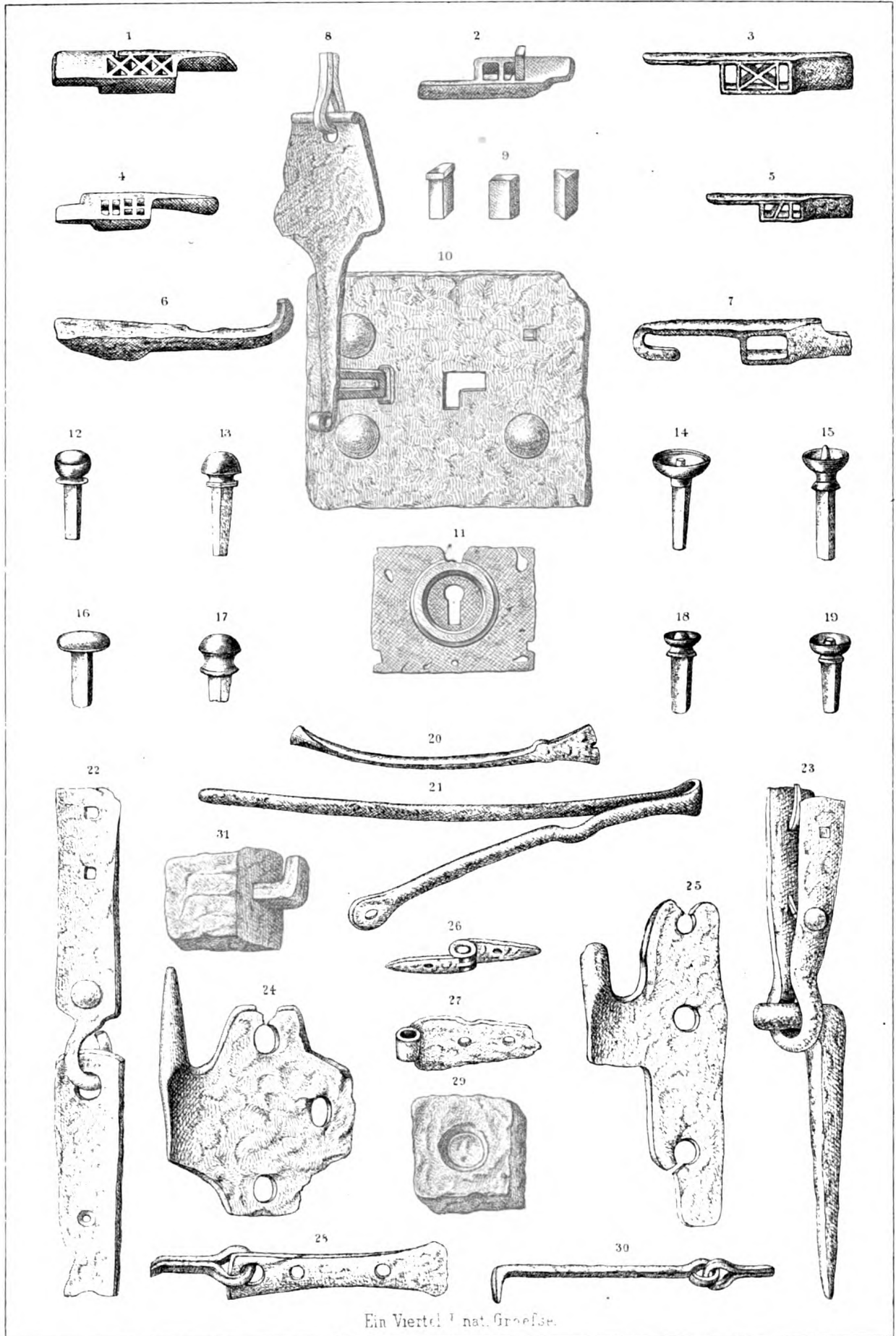

Ein Viertel nat. Gröfse.

Saalburg-Museum, Homburg v. d. H.

A. Faulstich Lith. Anst. Homburg

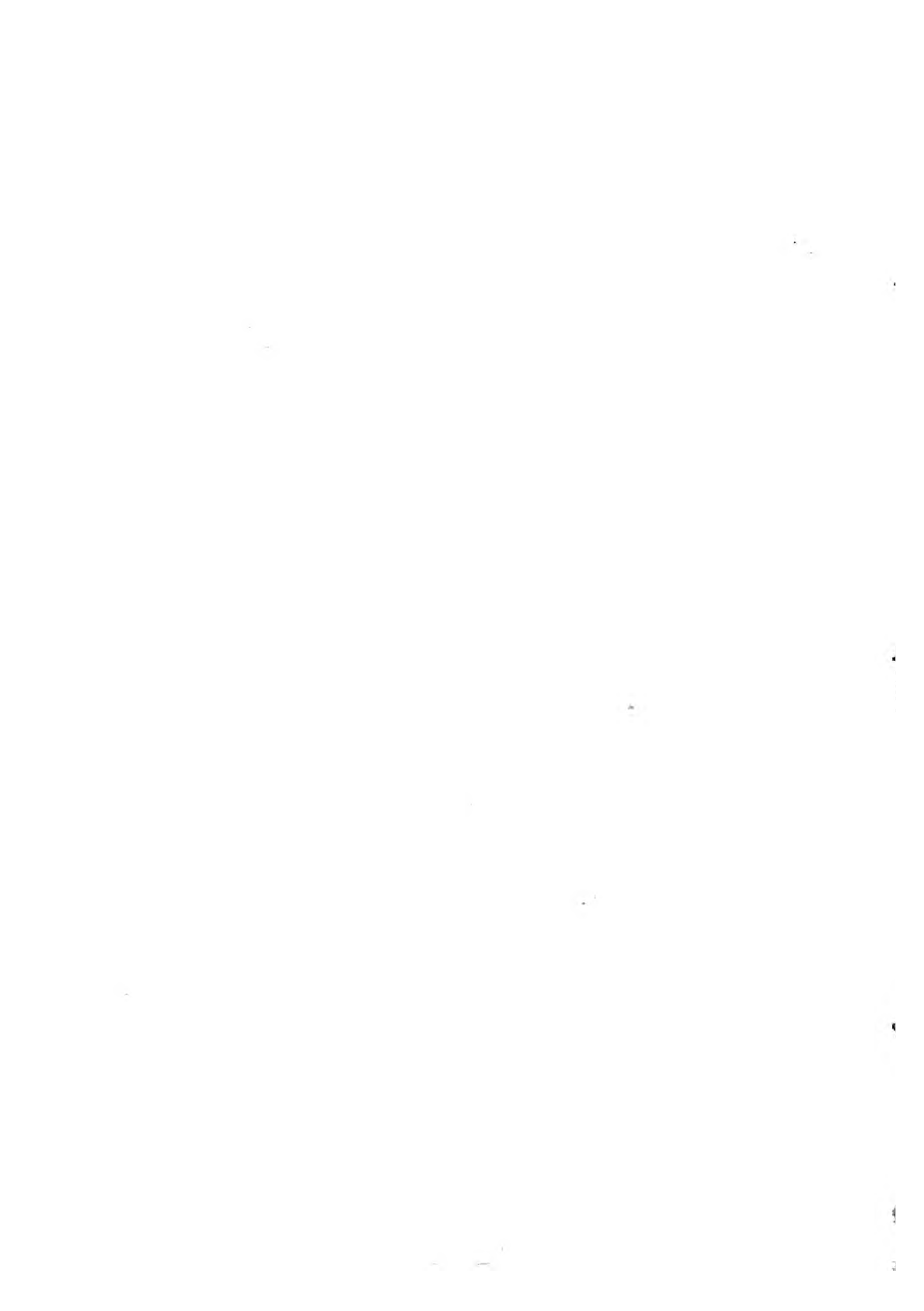

WERKZEUGE, GERÄTHE, WAFFEN & BESCHLÄGE.  
Die Saalburg.

Eisen.

TAFEL XXXVI.

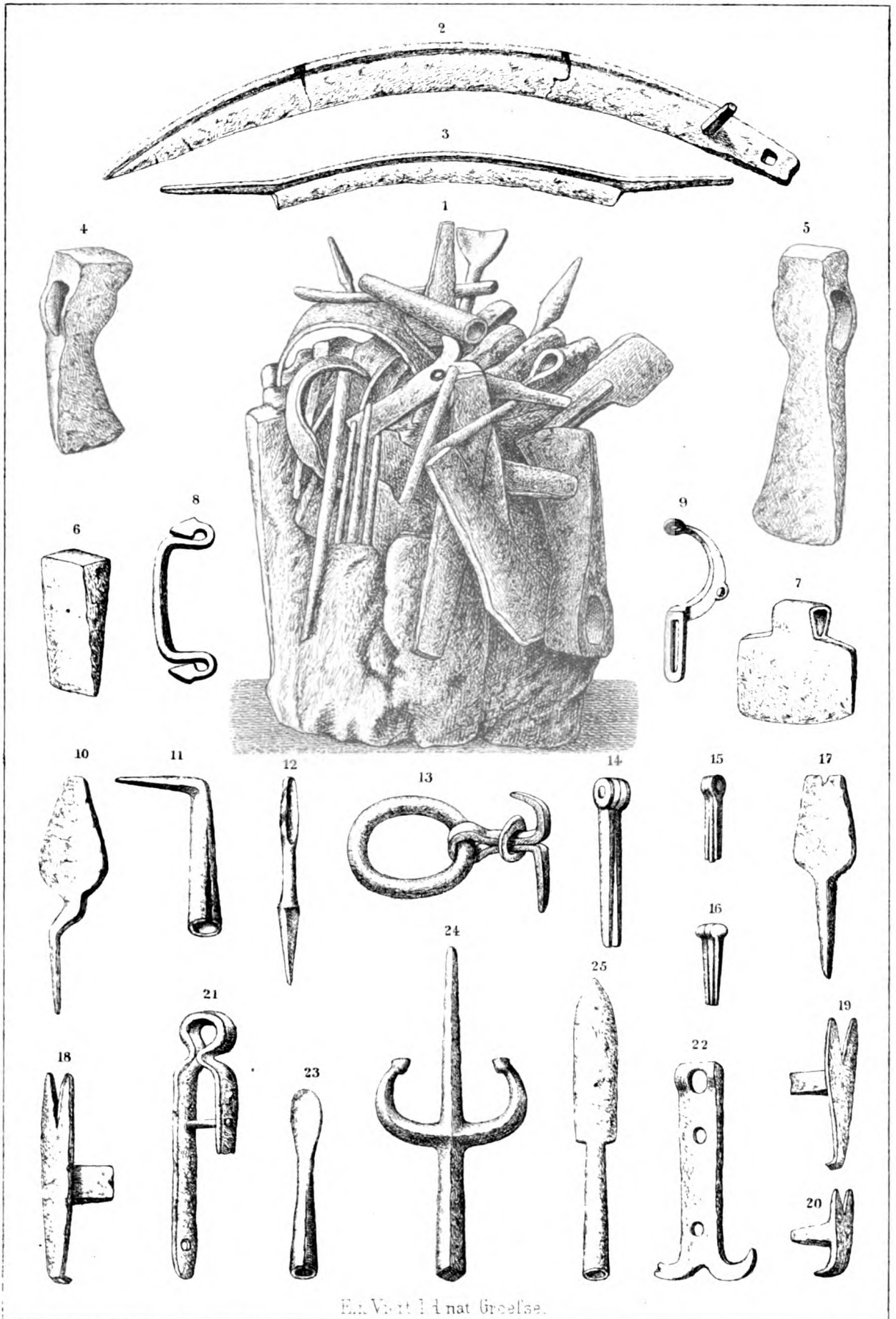

Ein Viertel d. nat. Gröfse.

Saalburg-Museum, Homburg v. d. H.

A. Pauck Lith. Anst. Homburg

THE UNIVERSITY OF CHICAGO

PHYSICS DEPARTMENT

PHYS 433

1982

1983

1984

1985

1986

1987

1988

1989

1990

1991

1992

1993

1994

1995

1996

1997

1998

1999

2000

2001

2002

2003

2004

2005

2006

2007

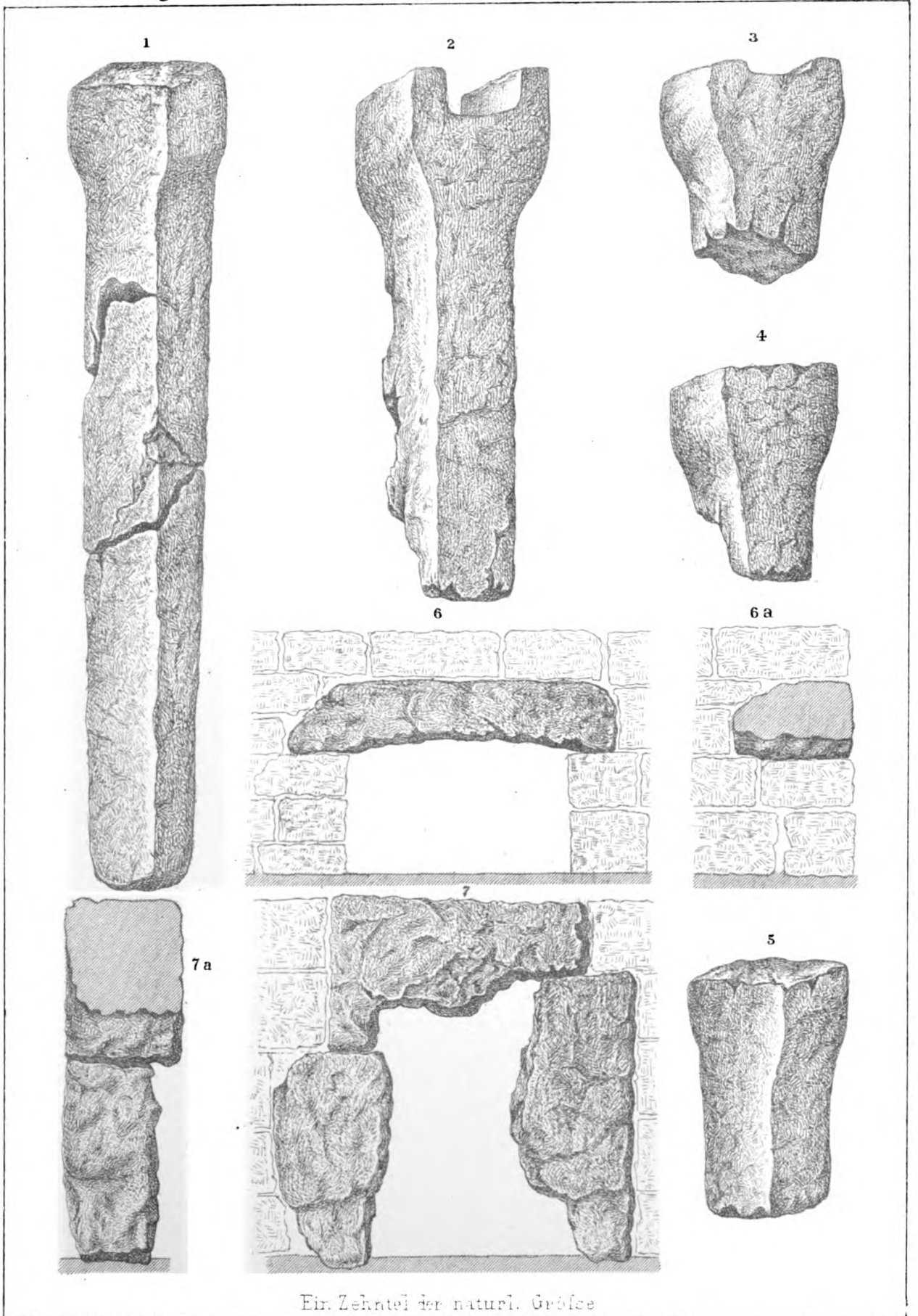

Ein Zehntel der natürl. Größe

Saalburg-Museum, Homburg v. d. H.

A. Bachmann del. F. Kopp sculp.



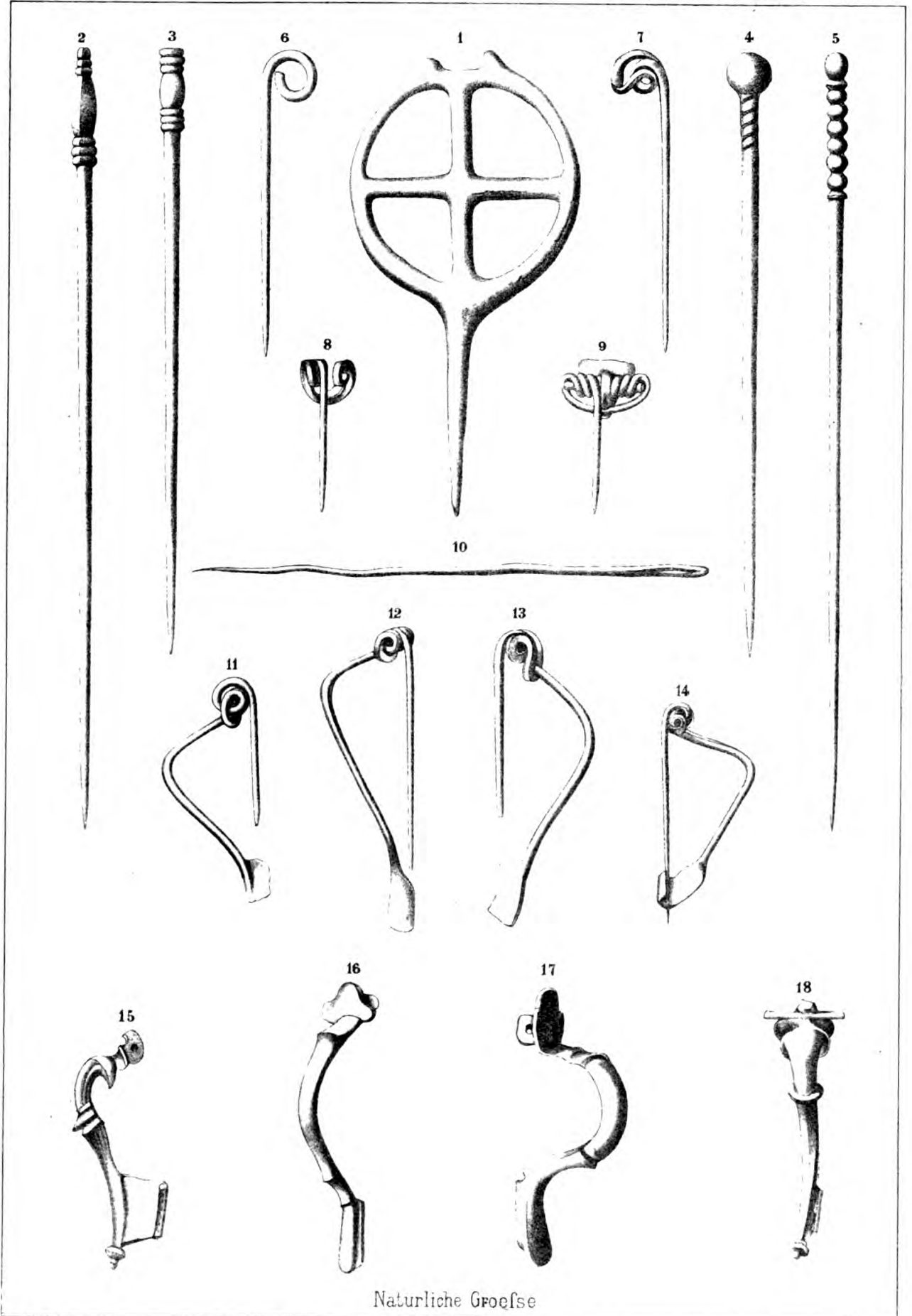

Natürliche Gröeße

Saalburg-Museum, Homburg v. d. H.

*A. v. L. v. d. H.*



\_\_\_\_\_

\_\_\_\_\_

\_\_\_\_\_

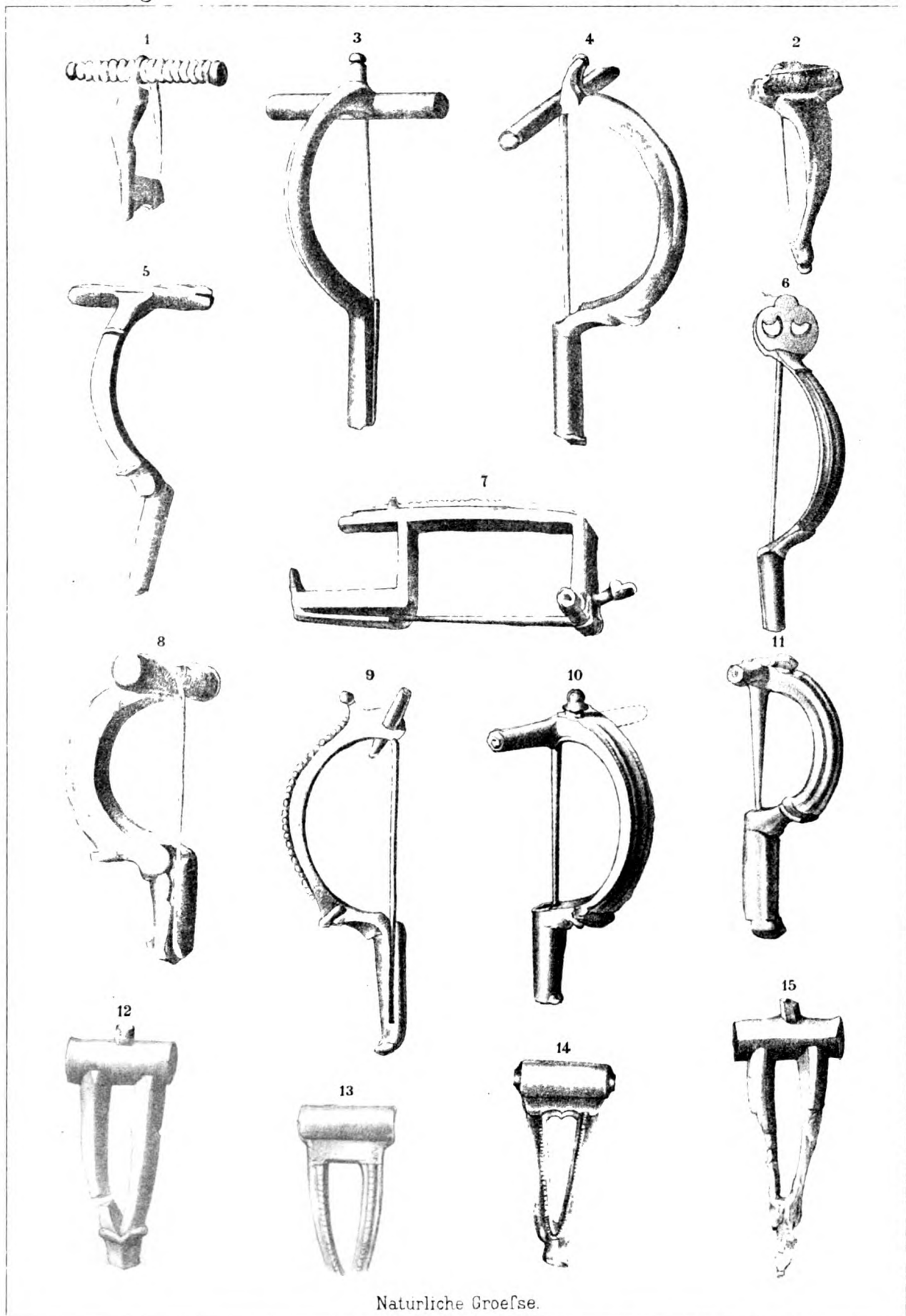

Natürliche Groefse.



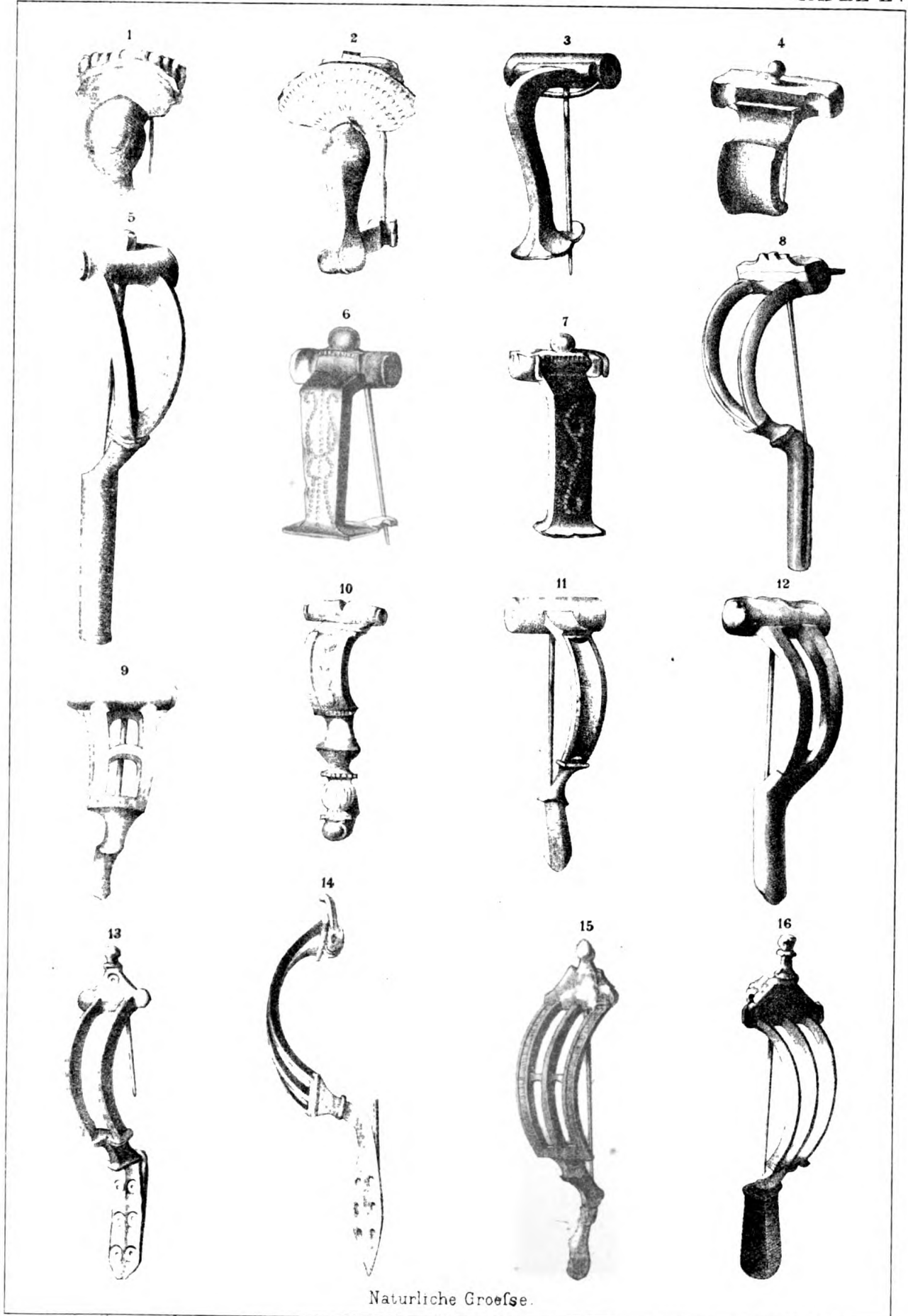

Natürliche Gröesse.

Saalburg-Museum, Homburg v.d.H.

A Pauli, Lith. Anst., Homburg



GEWANDNADELN.

Bronze.

TAFEL LI

DieSaalburg.

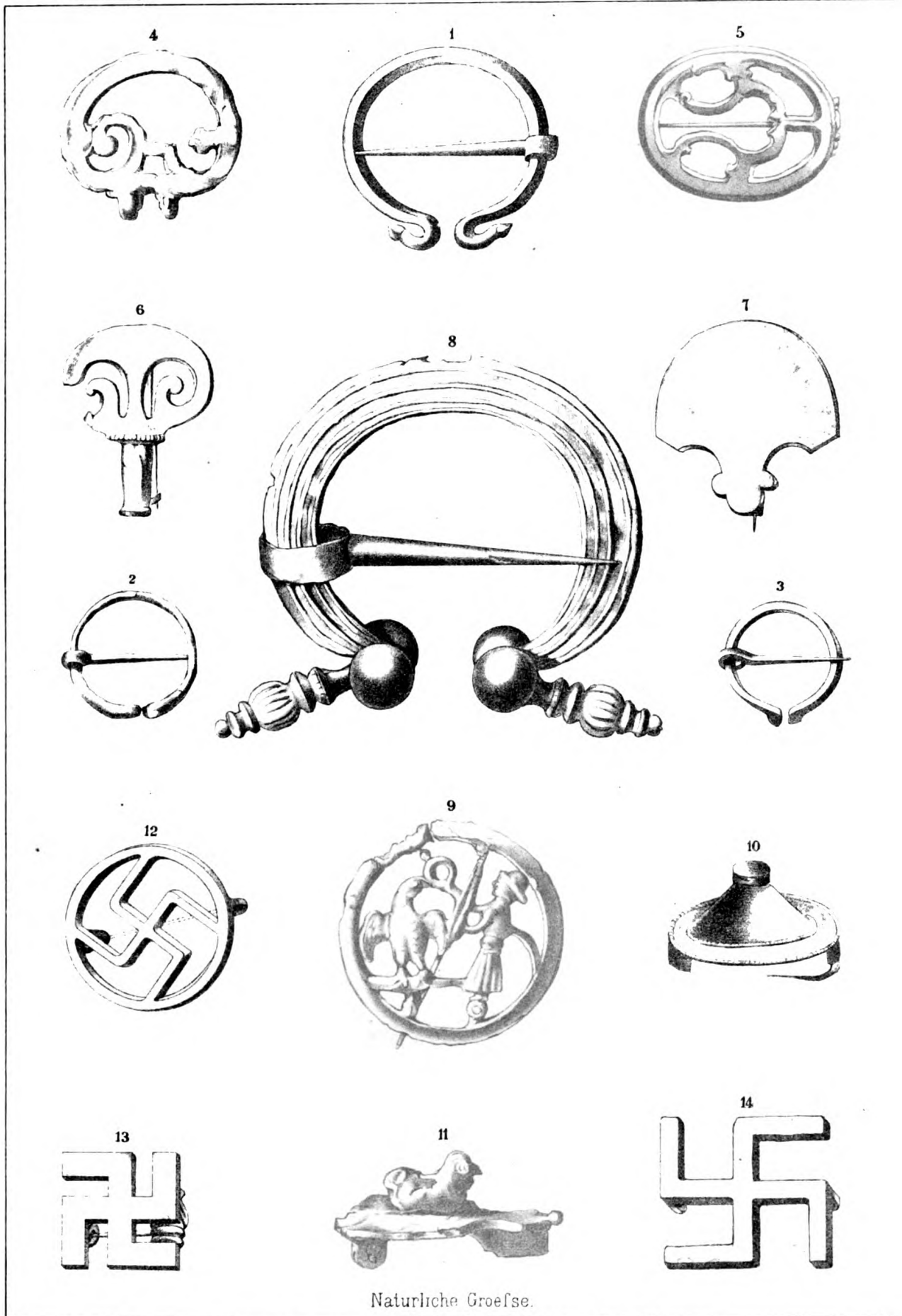

Natürliche Gröfse.

Saalburg-Museum, Homburg v. d. H.

A Pauli Lith. Anst. Homburg

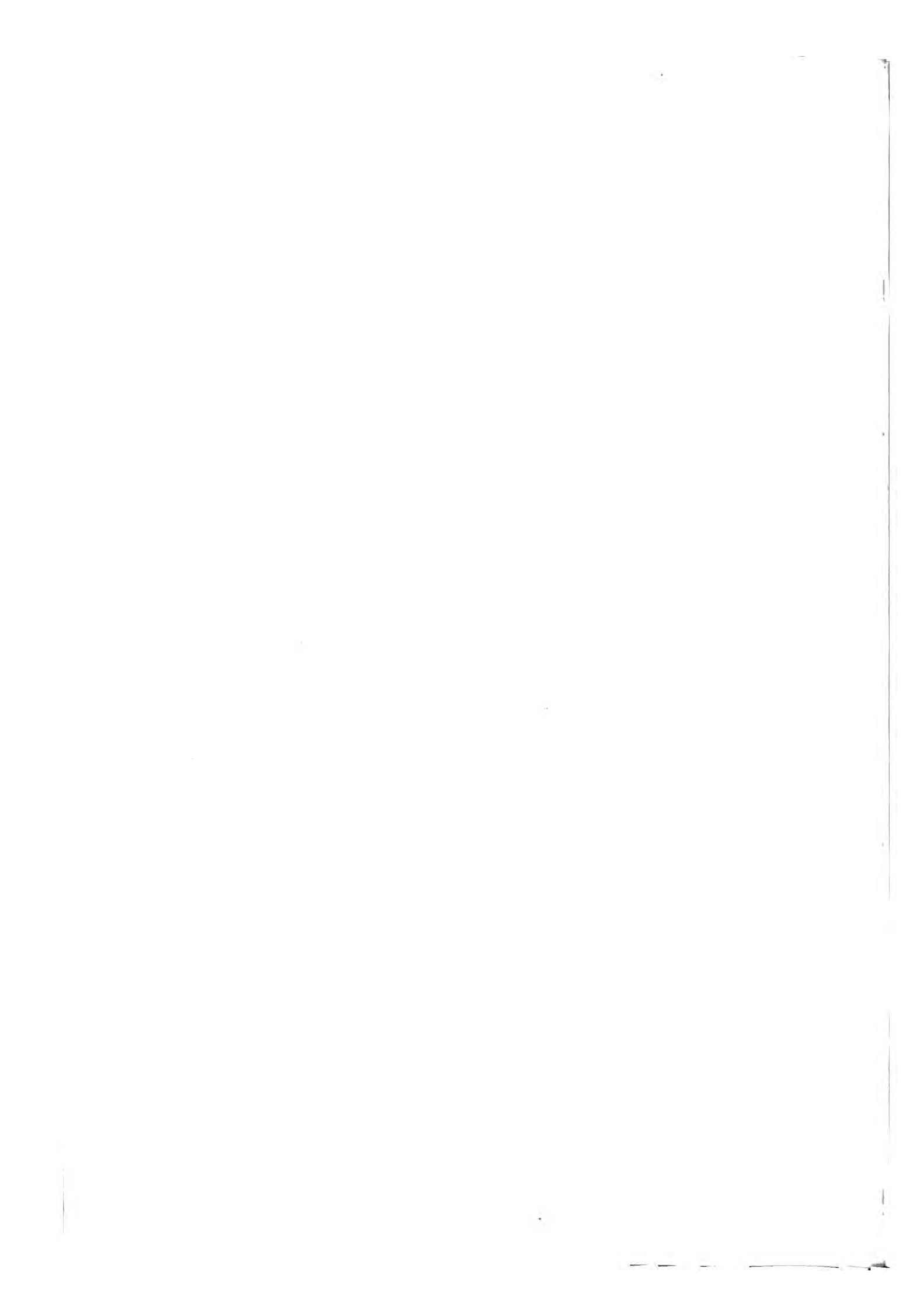

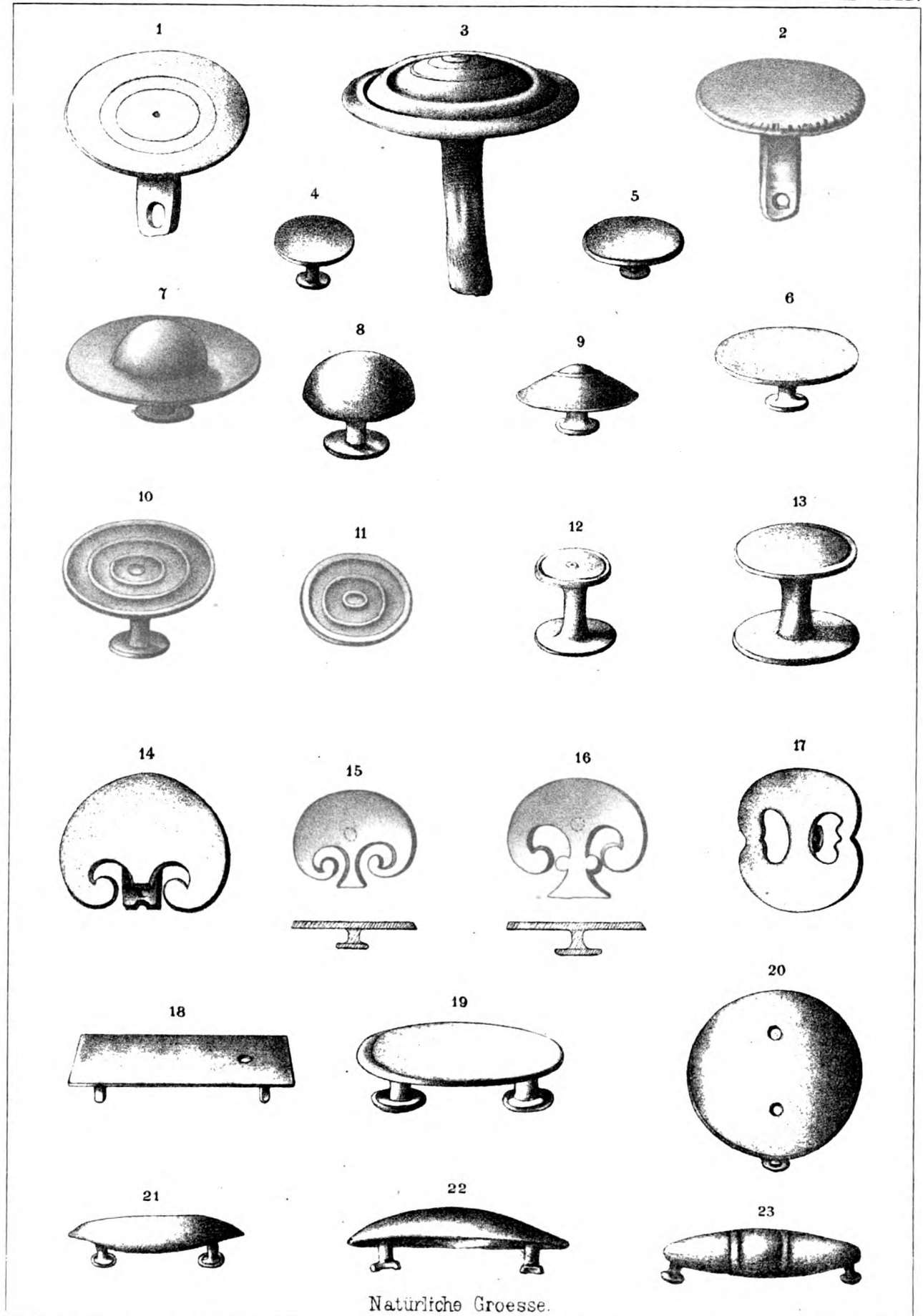

Natürliche Grösse.





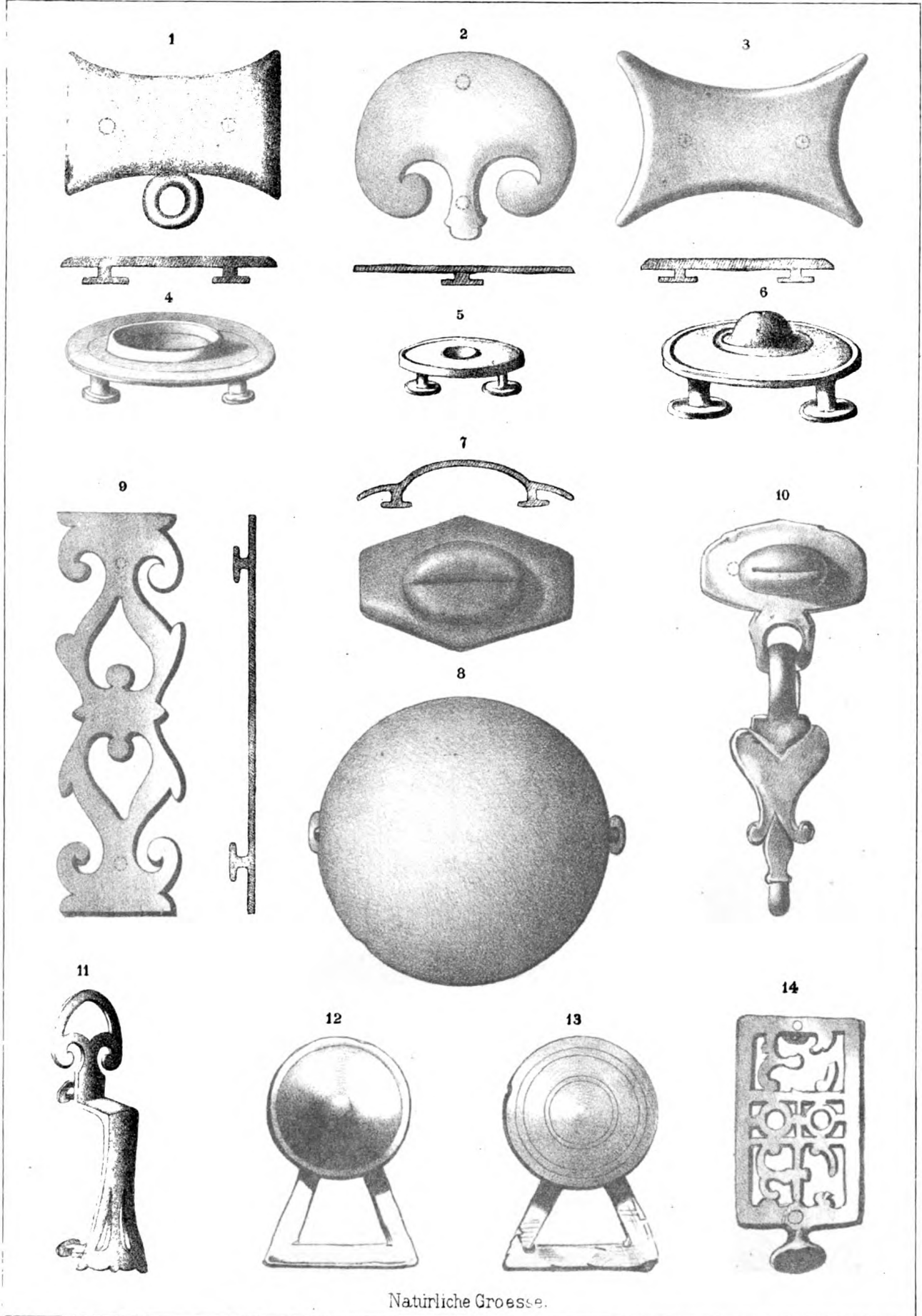

Natürliche Grösse.



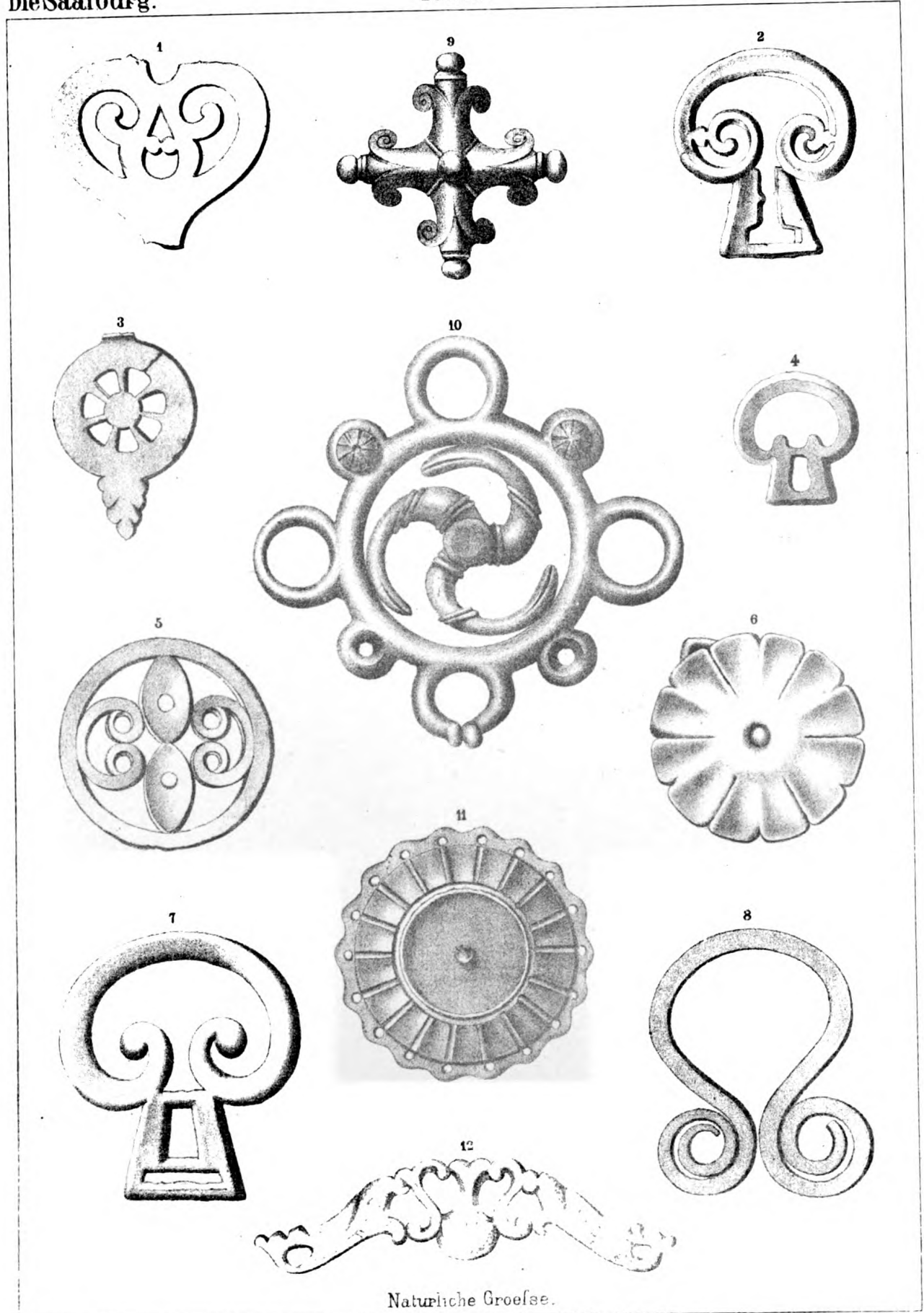

Natürliche Gröfse.



PHALERAE & SCHEIDENBESCHLAEGE.

DieSaalburg.

Bronze.

TAFEL LV.

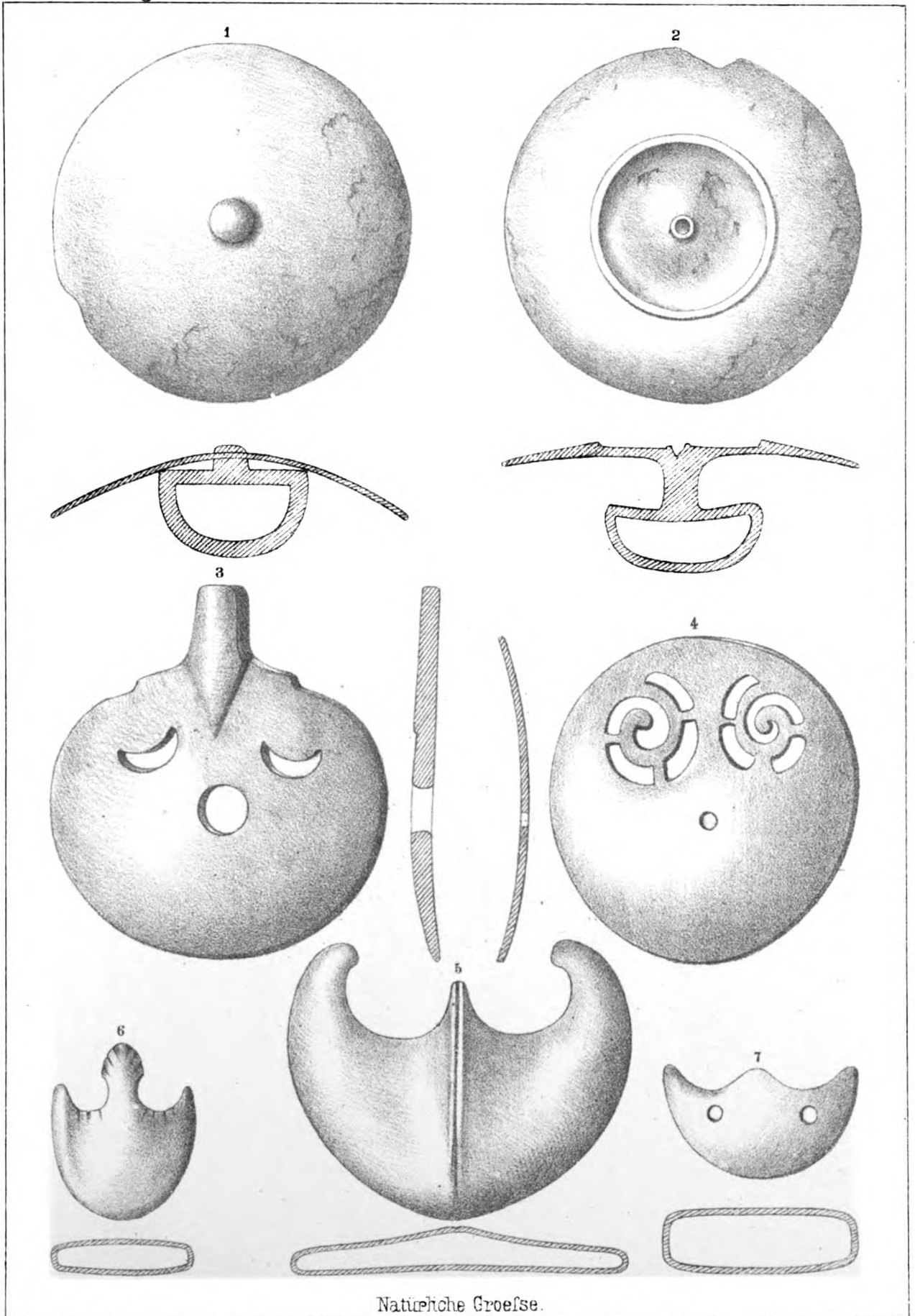

Natürliche Gröesse.

Saalburg-Museum, Homburg v. d. H.

A. Pauli, Lith. Anst. Homburg.



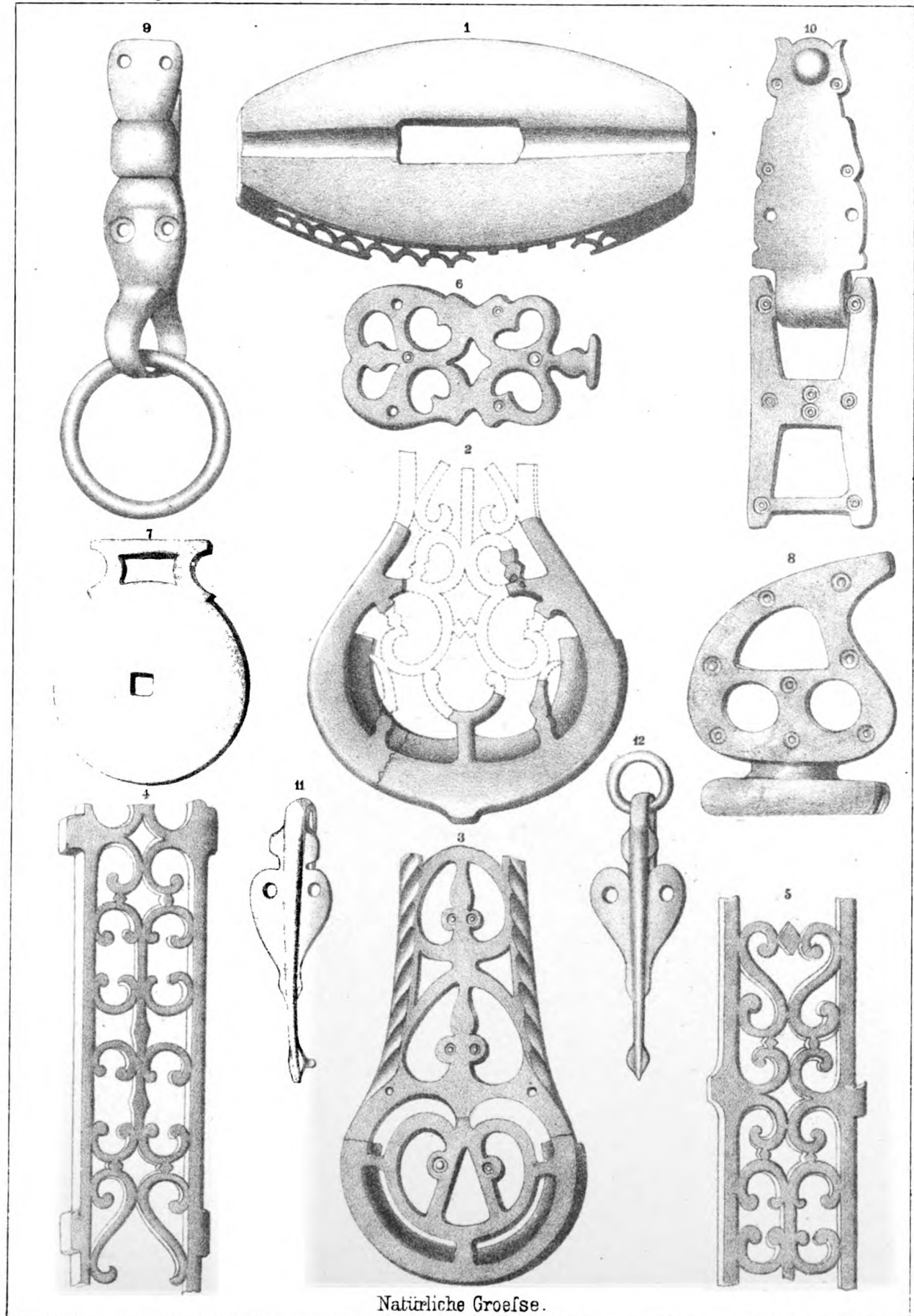

Natürliche Groefse.

Saalburg-Museum, Homburg v. d. H.

A Pauli, Lith. Anst. Homburg



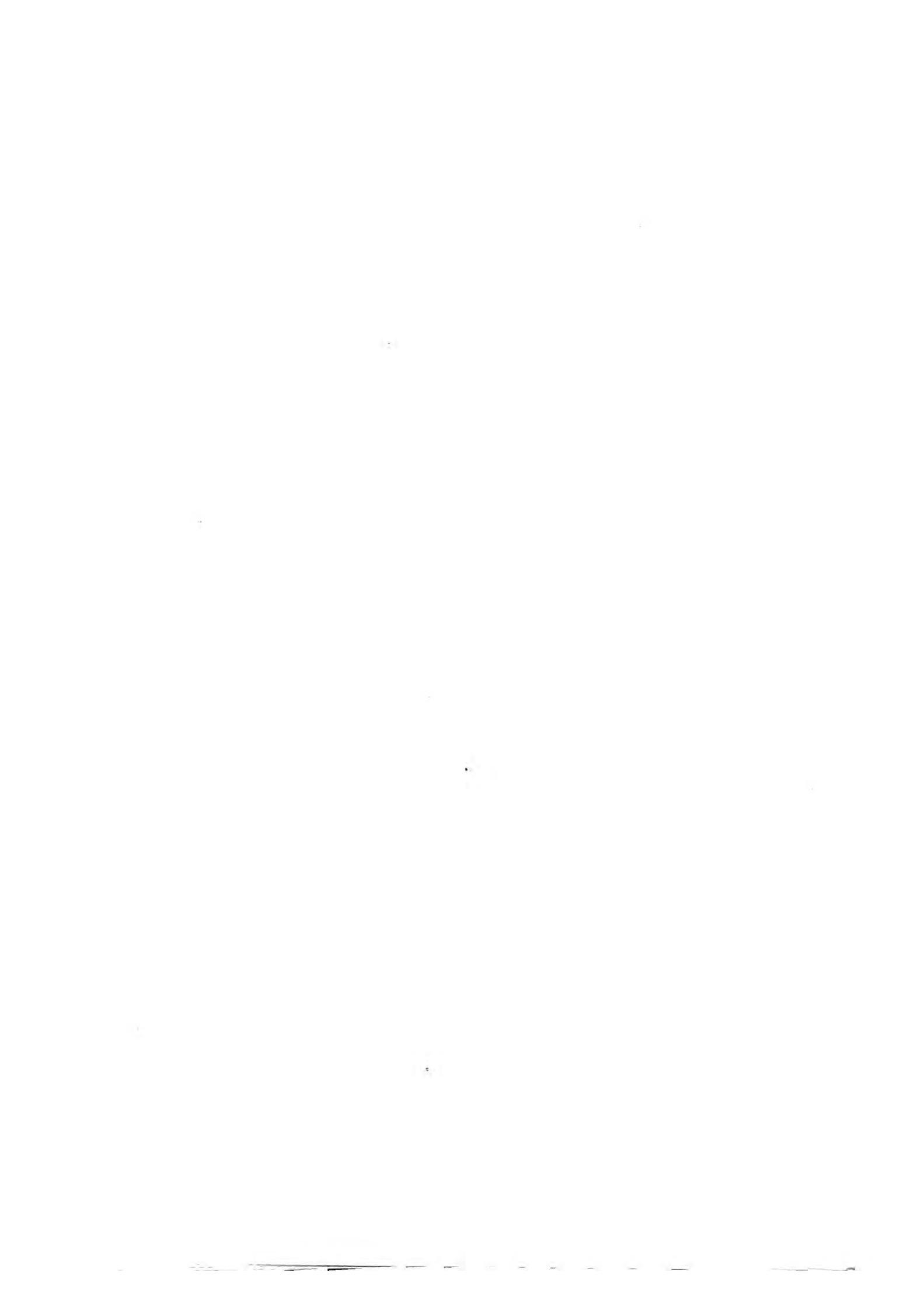

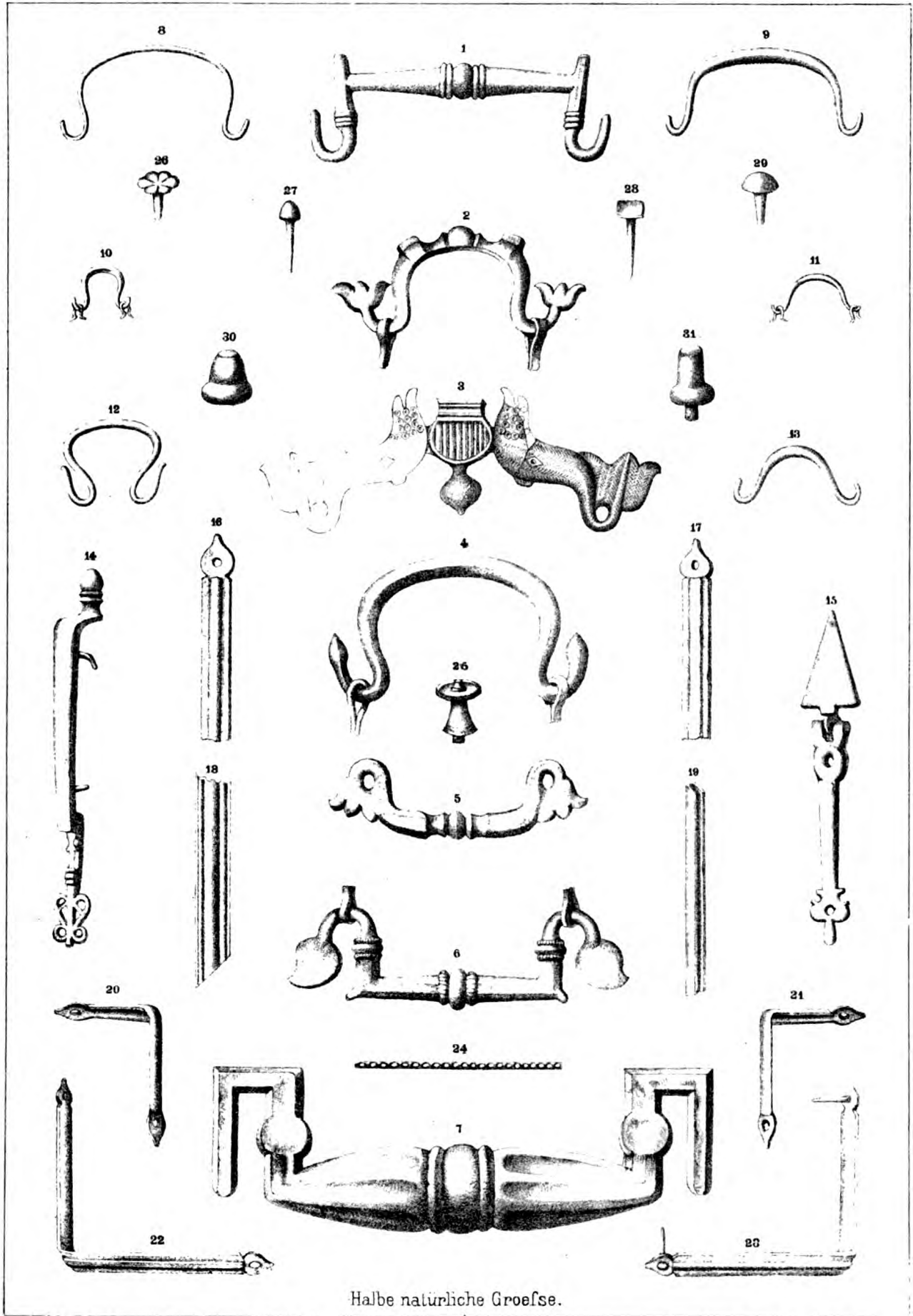

Halbe natürliche Gröfse.

Saalburg-Museum, Homburg v. d. H.

A Pauli Lith. Anst, Homburg



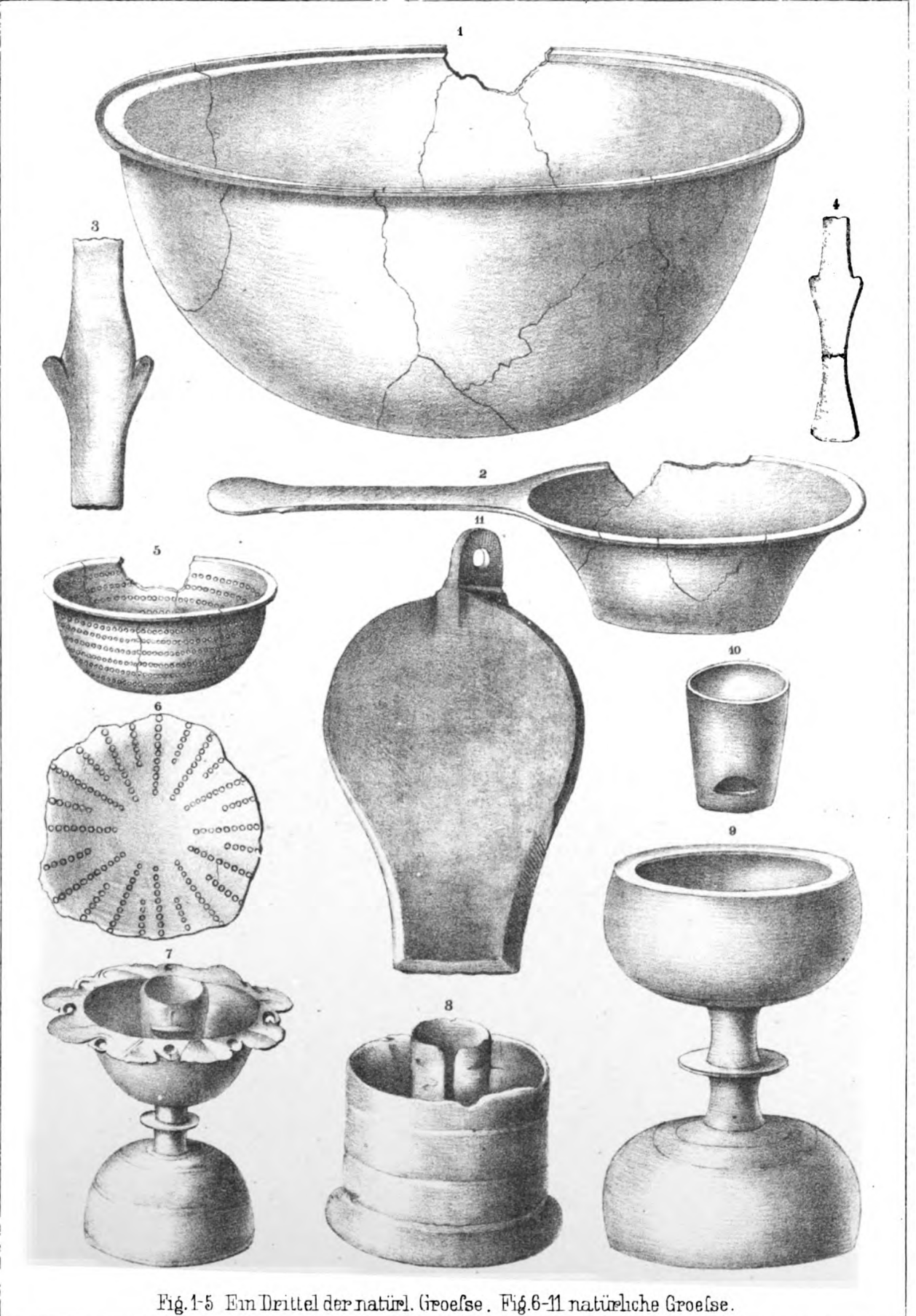

Fig. 1-5 Ein Drittel der natürl. Gröesse. Fig. 6-11 natürliche Gröesse.

Saalburg-Museum, Homburg v. d. H.

A. Pauli Lith. Anst. Homburg



**GESCHIRRBESCHLAEGE, SCHELLEN & SCHNALLEN.**

Die Saalburg.

Bronze.

TAFEL LIX.

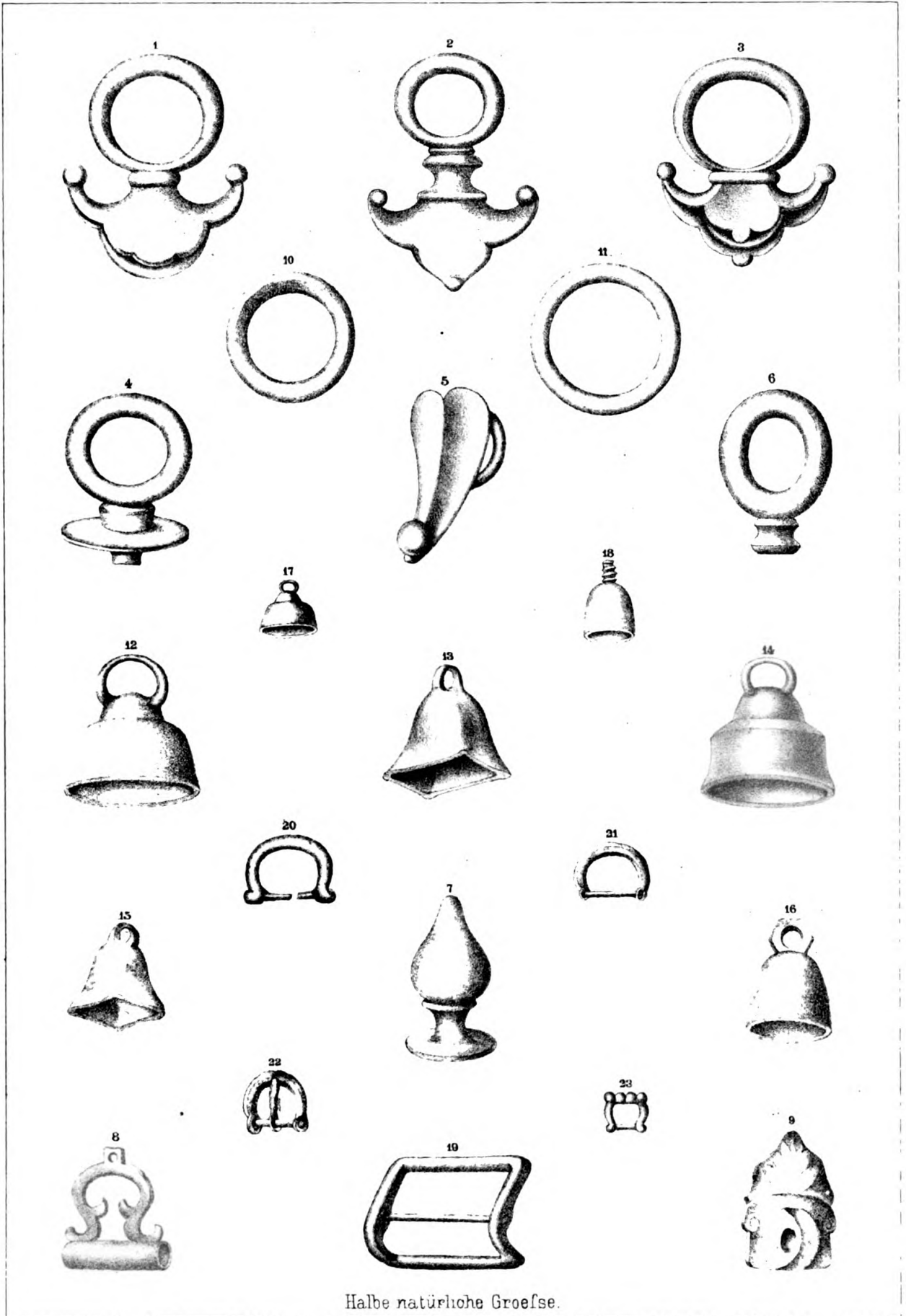

Halbe natürliche Groefse.

Saalburg-Museum, Homburg v. d. H.

A Pauli Lith Anst, Homburg.

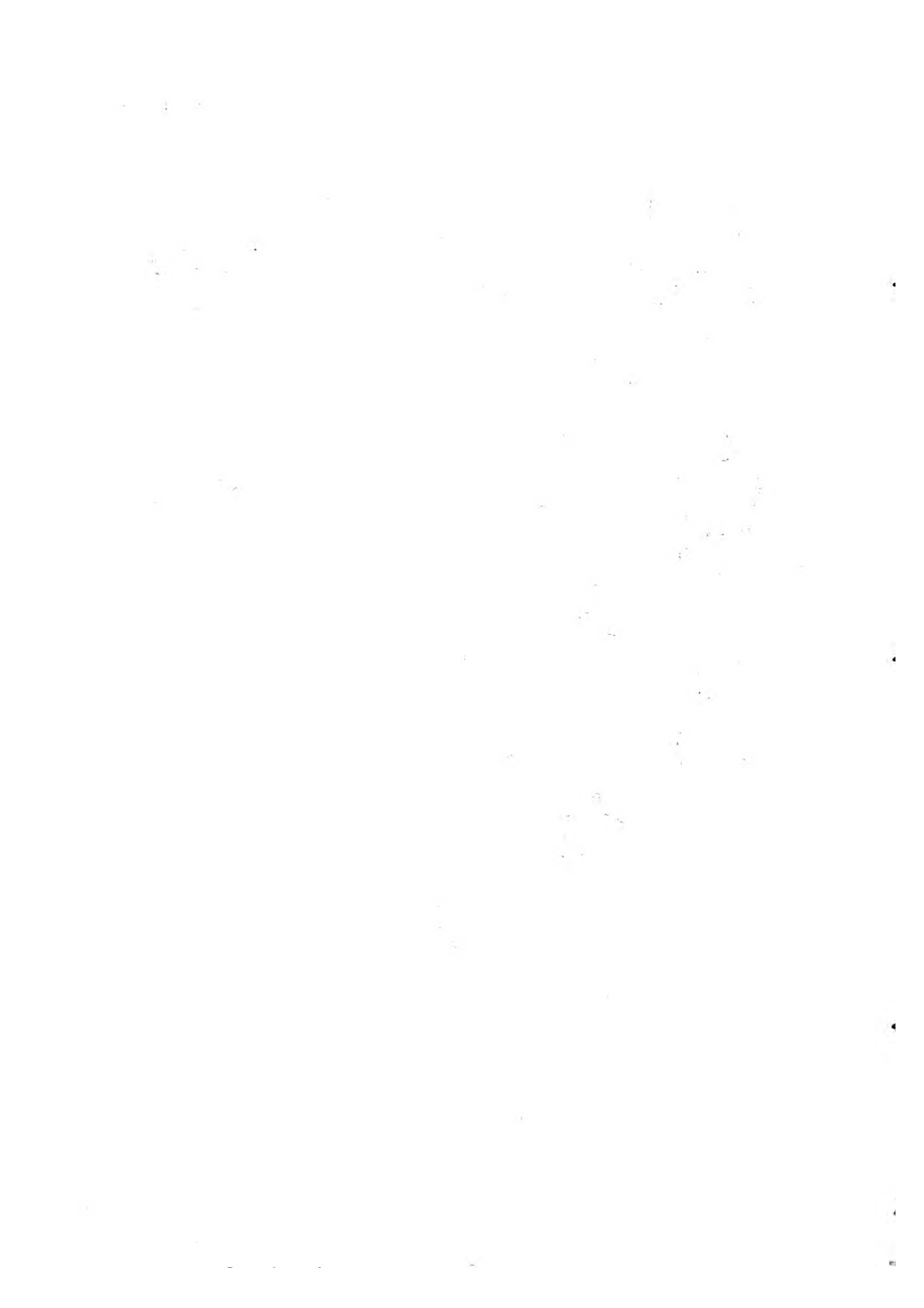

# HELMTHEILE, WAFFEN- & MESSERGRIFFE.

1-9 Bronze, 10 Eisen, 11-13 Horn.

Die Saalburg

TAFEL LX.

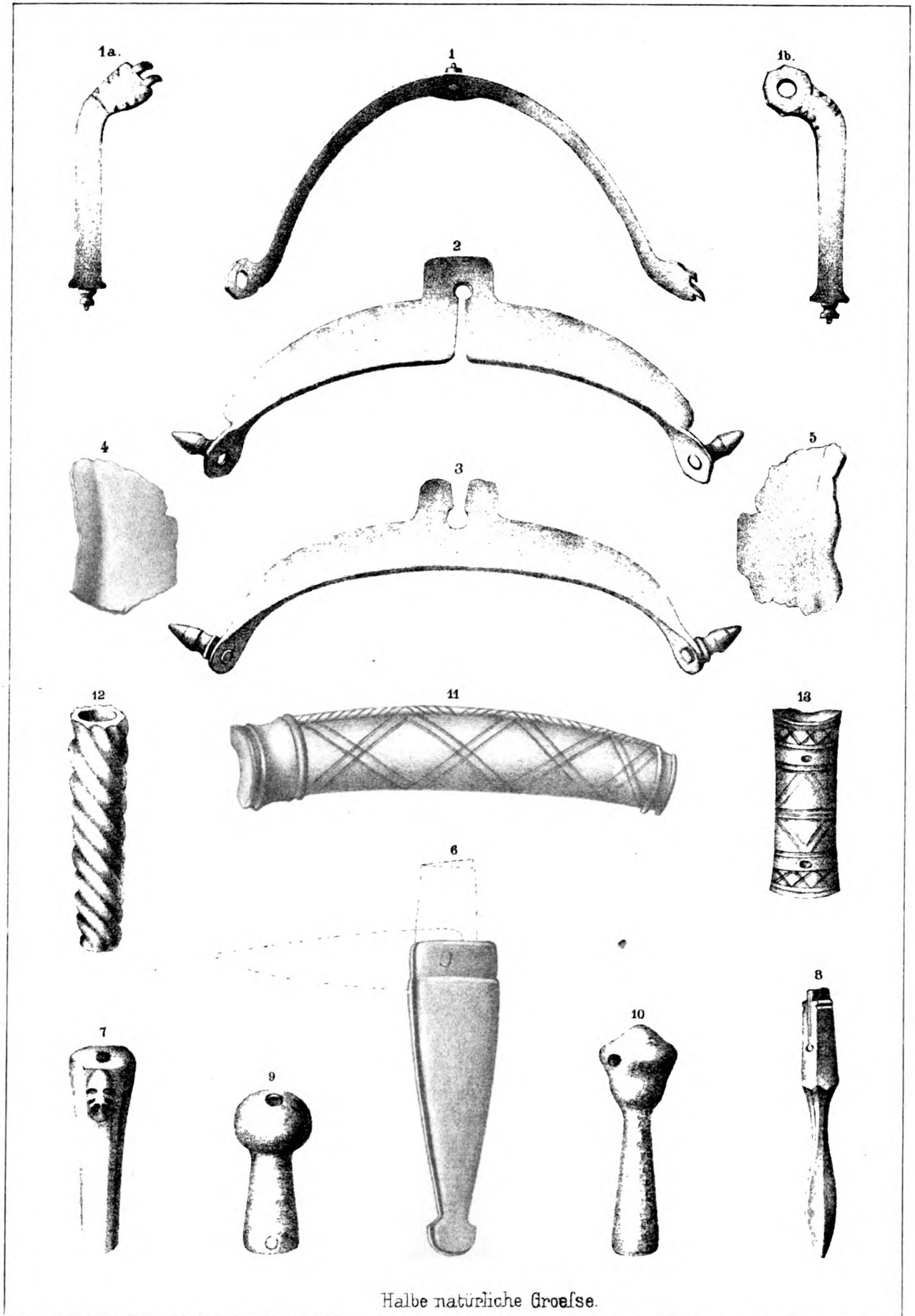

Halbe natürliche Gröfse.

Saalburg-Museum, Homburg v. d. H.

A. Feiler lith. Anst., Homburg





# METALLSPIEGEL & GRIFFE. Bronze.

TAFEL LXI.

Die Saalburg.

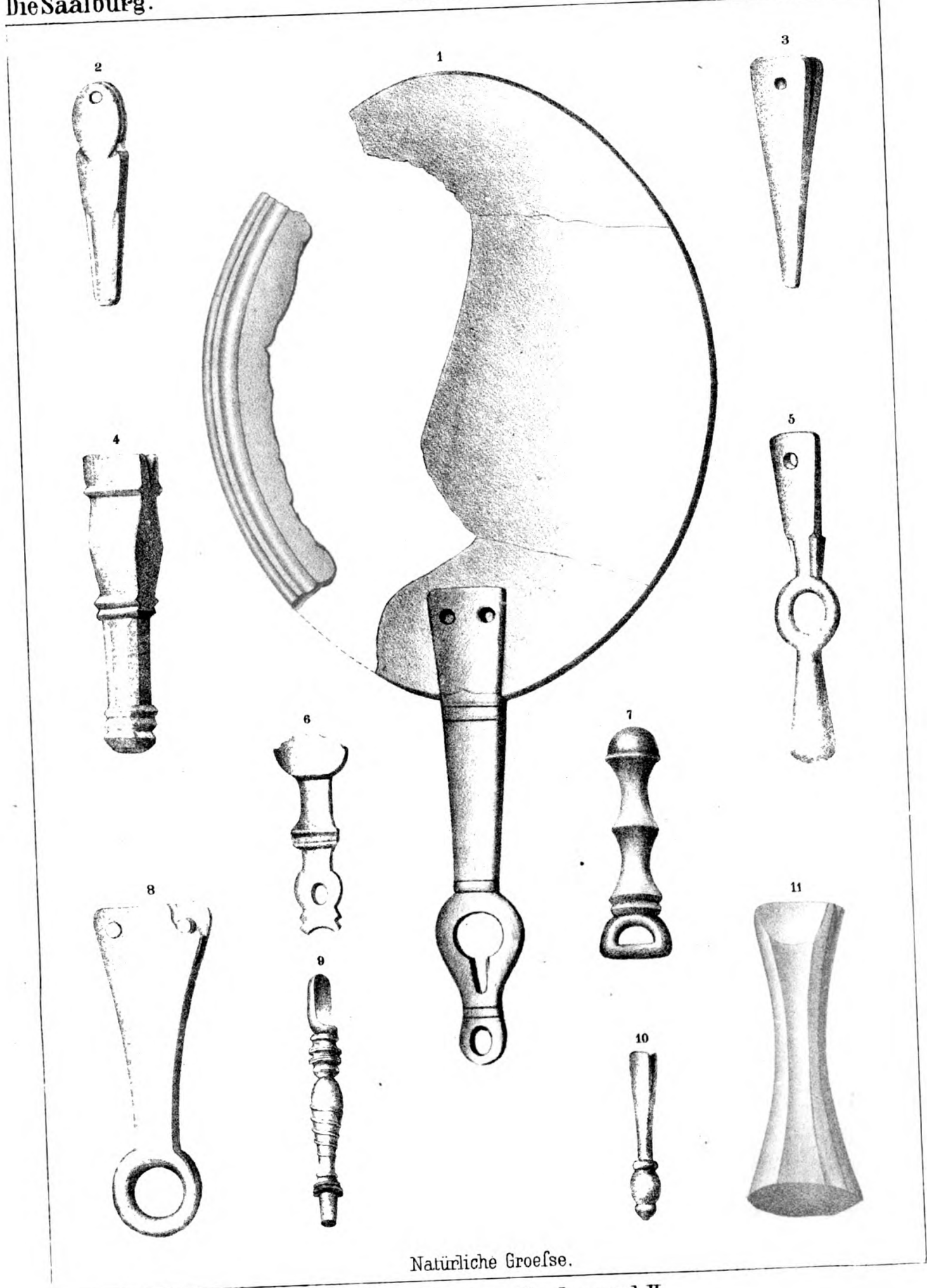

Natürliche Groefse.

Saalburg-Museum, Homburg v. d. H.

A. Pauli Lith. Anst., Homburg.



AERZTLICHE INSTRUMENTE.

Bronze.

TAFEL LXII.

Die Saalburg.

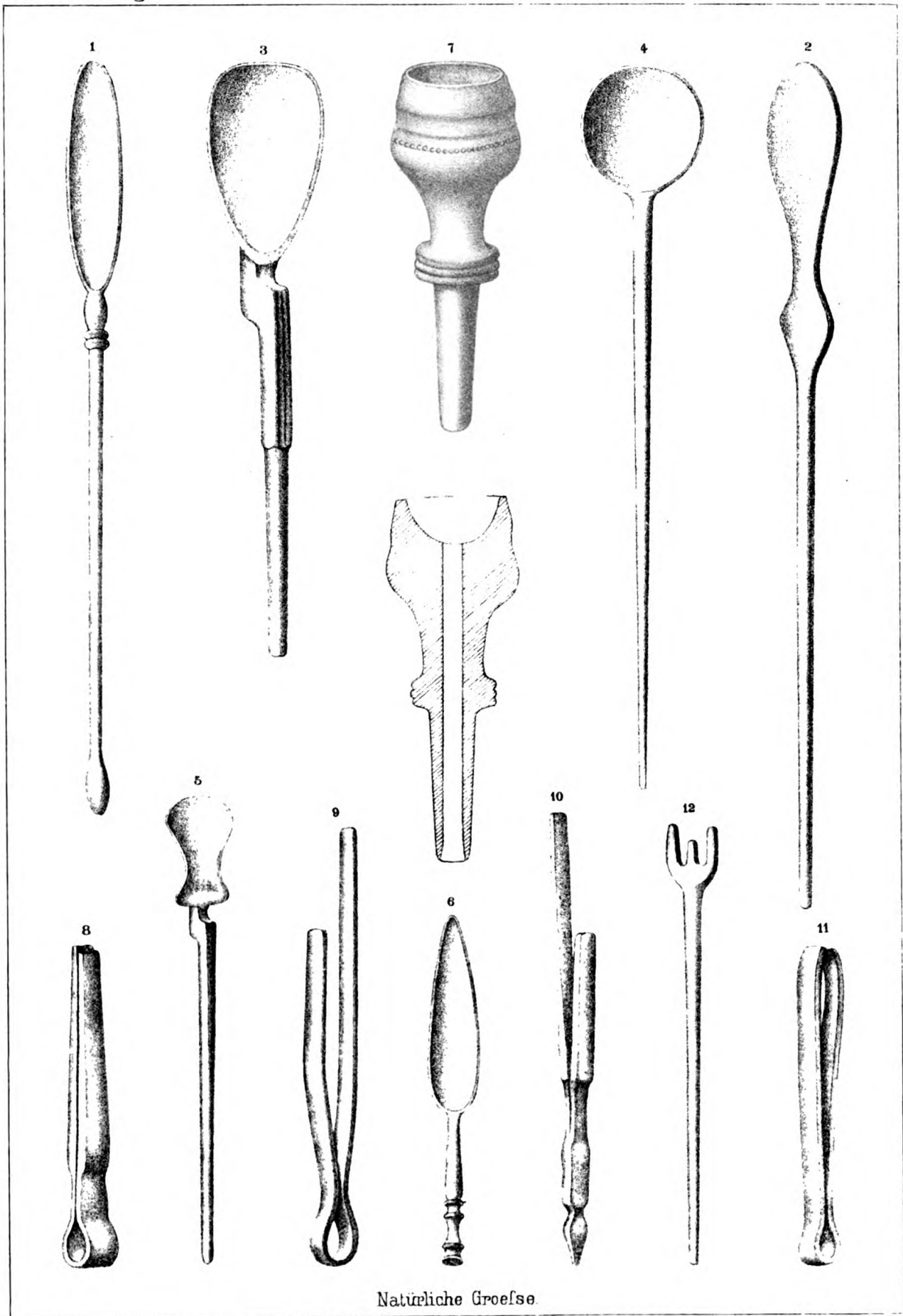

Natürliche Größe.

Saalburg-Museum, Homburg v. d. H.

A Pauli Lith. Anst., Homburg



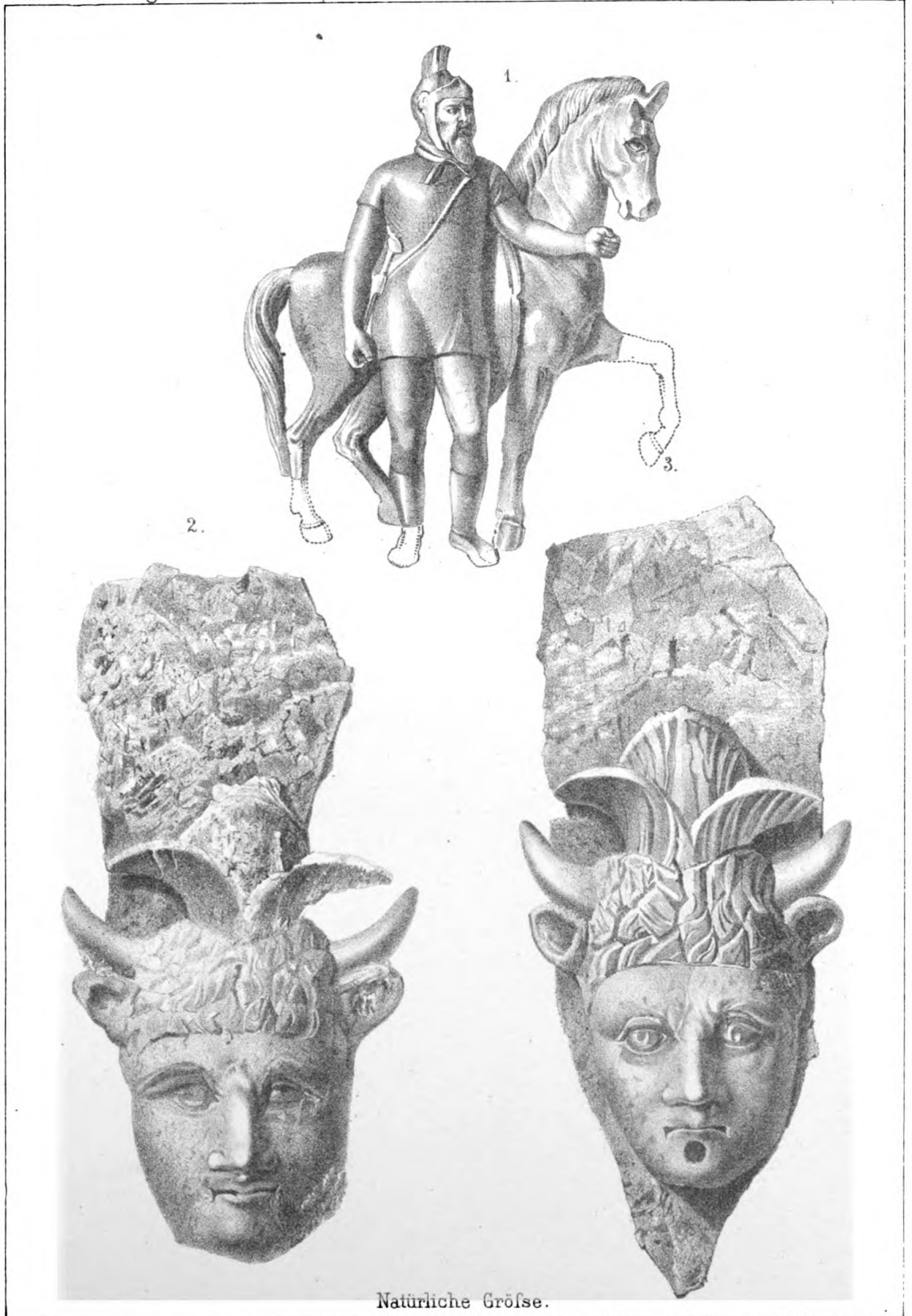

Natürliche Gröfse.

Saalburg-Museum, Homburg v. d. H.

A. Pauli, Lith. Anst. Homburg

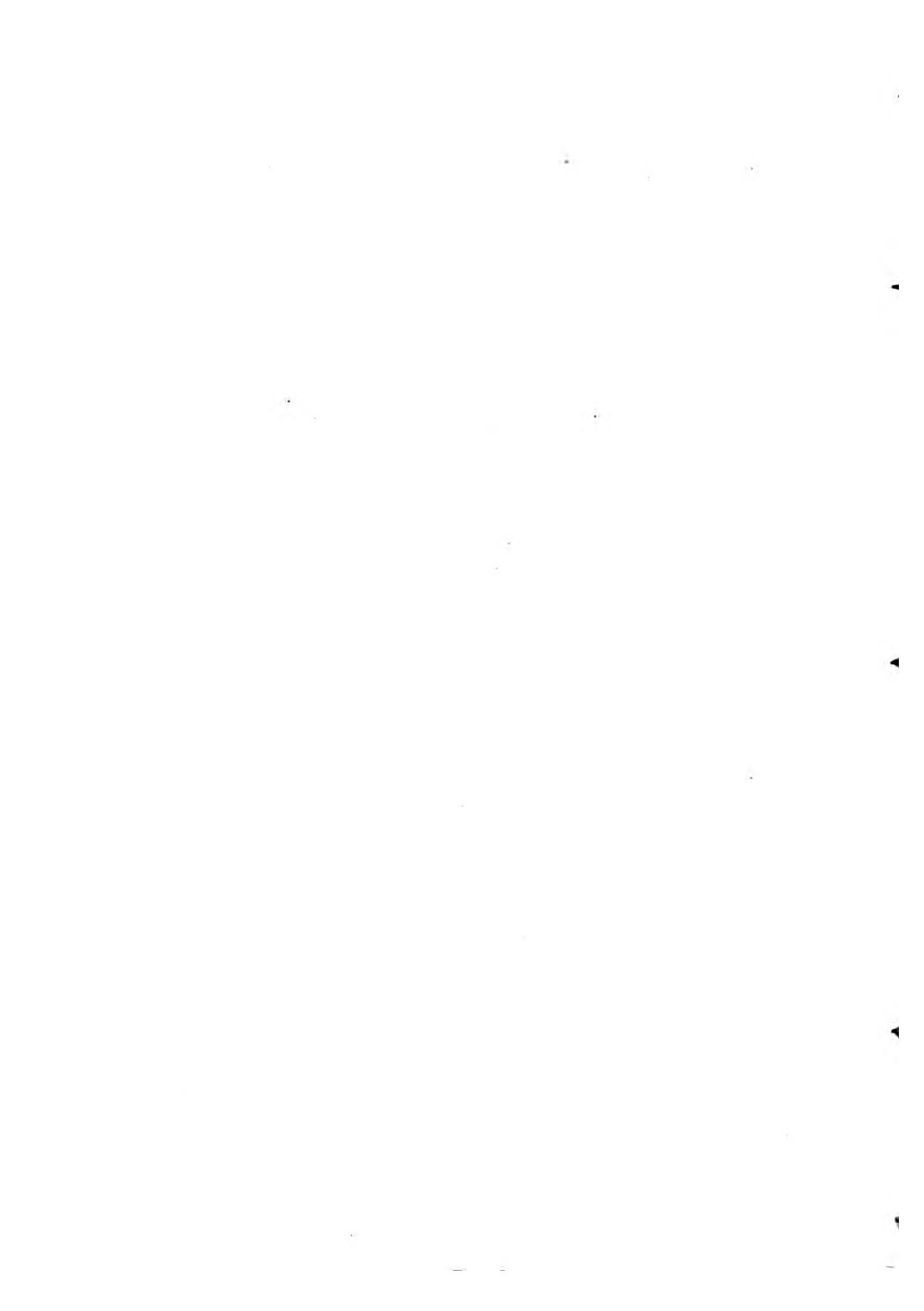

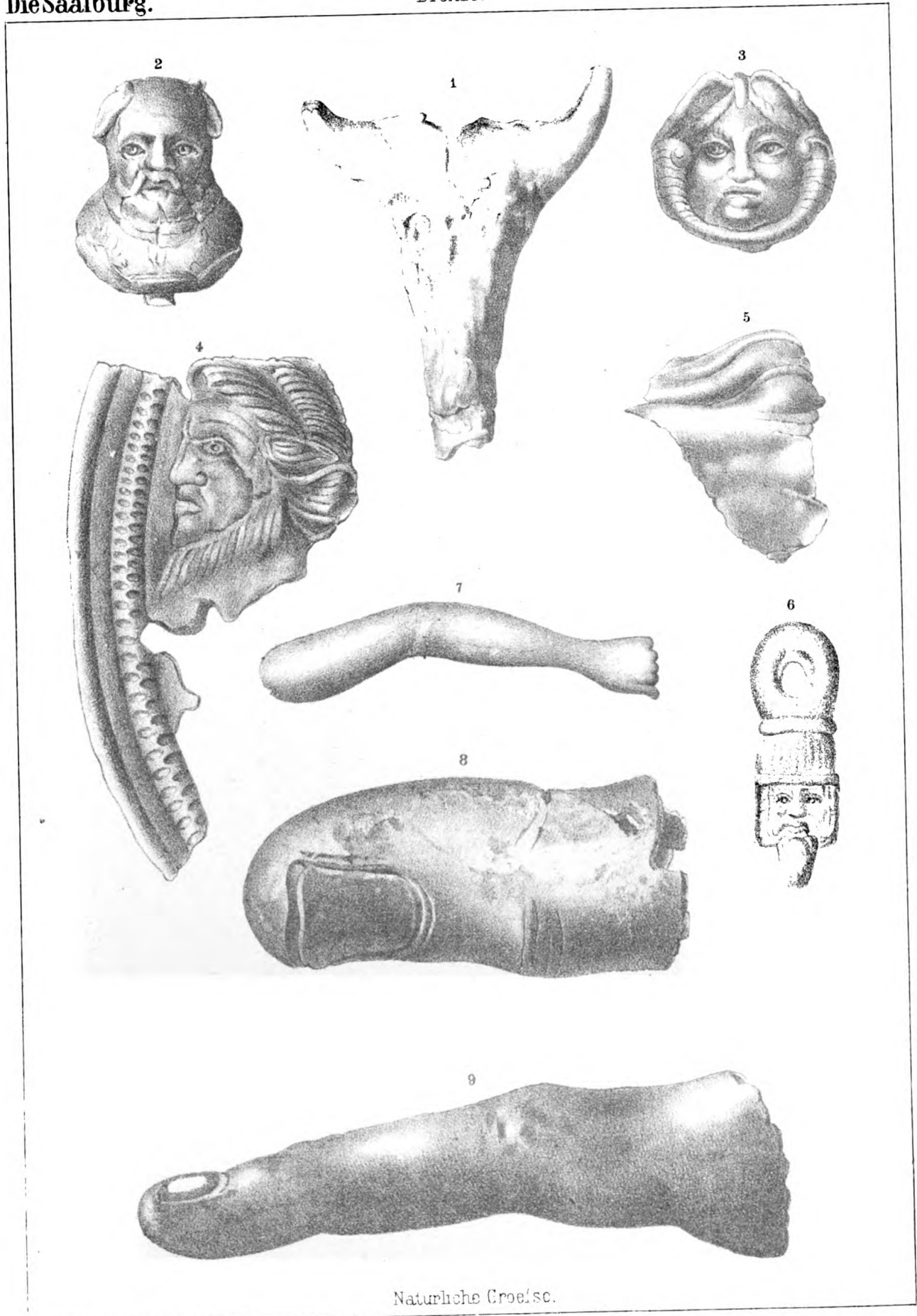

Natürliche Größe.

Saalburg-Museum, Homburg v.d. H.

A. Frank Lith. Anst. Homburg



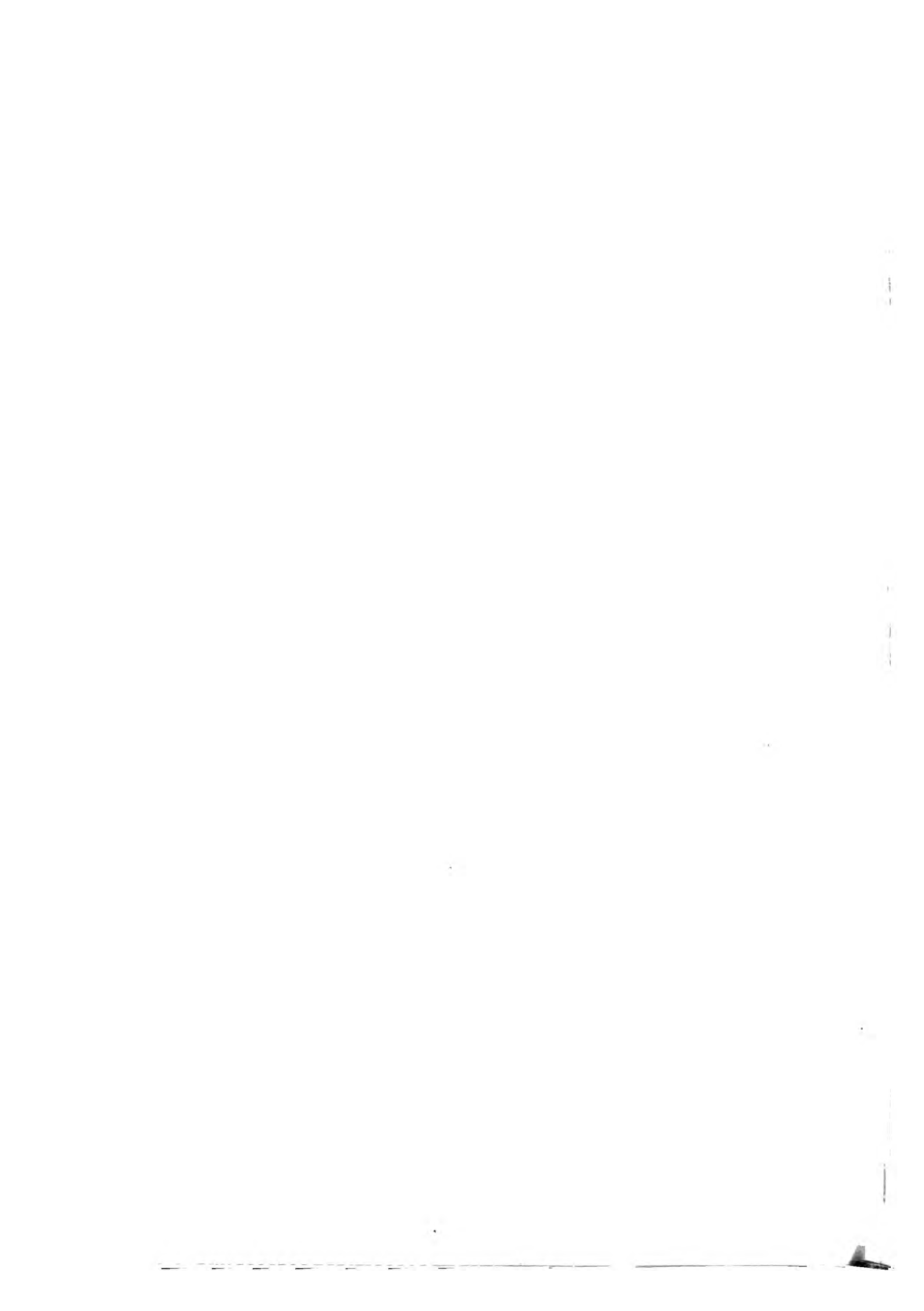

BRUCHSTUECKE VON FIGUREN & ORNAMENTEN.

Die Saalburg.

Bronze.

TAFEL LXV.

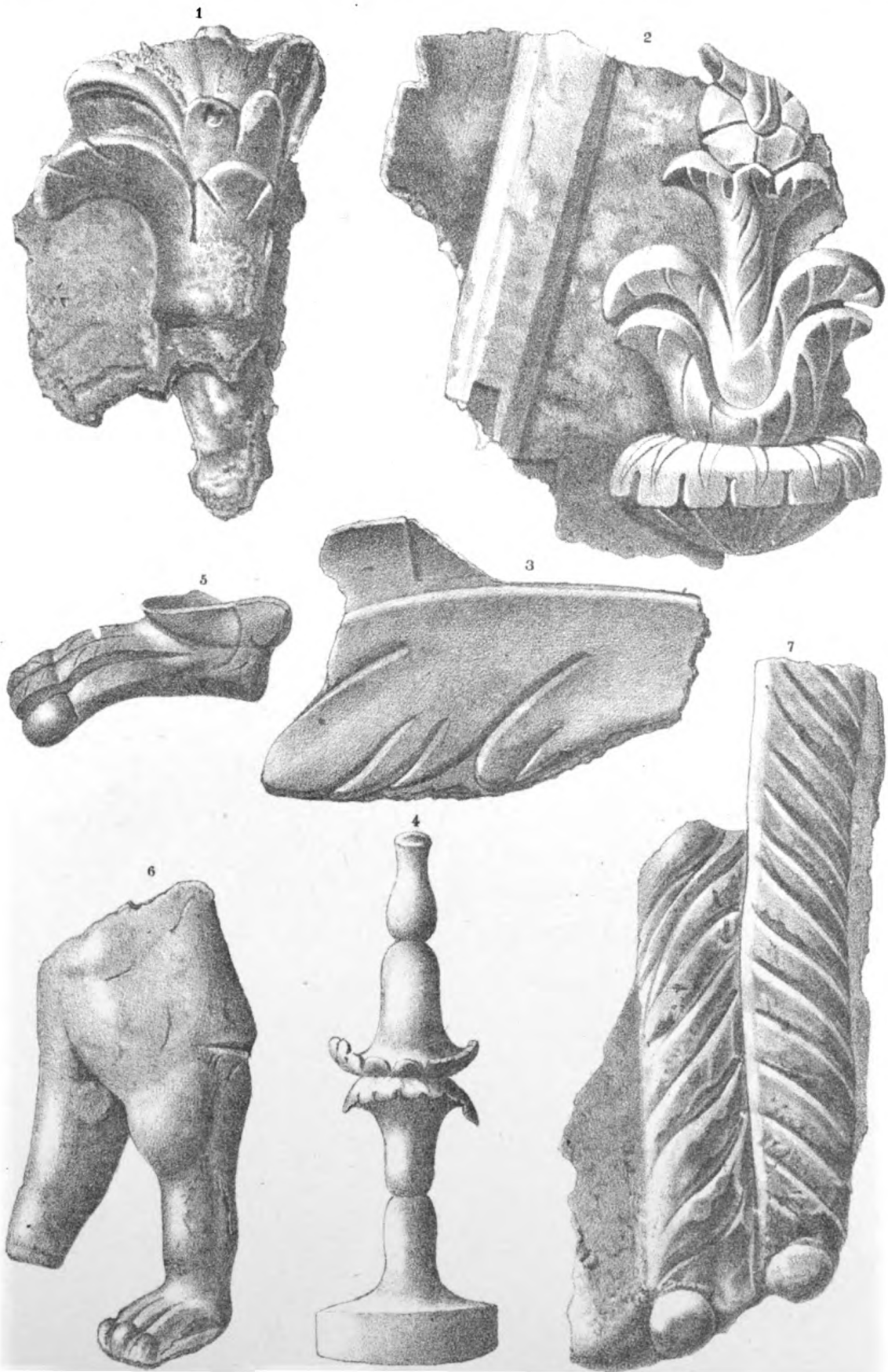

Natürliche Größe.

Saalburg-Museum, Homburg v. d. H.

A. Faulk, Lith. Anst., Homburg.



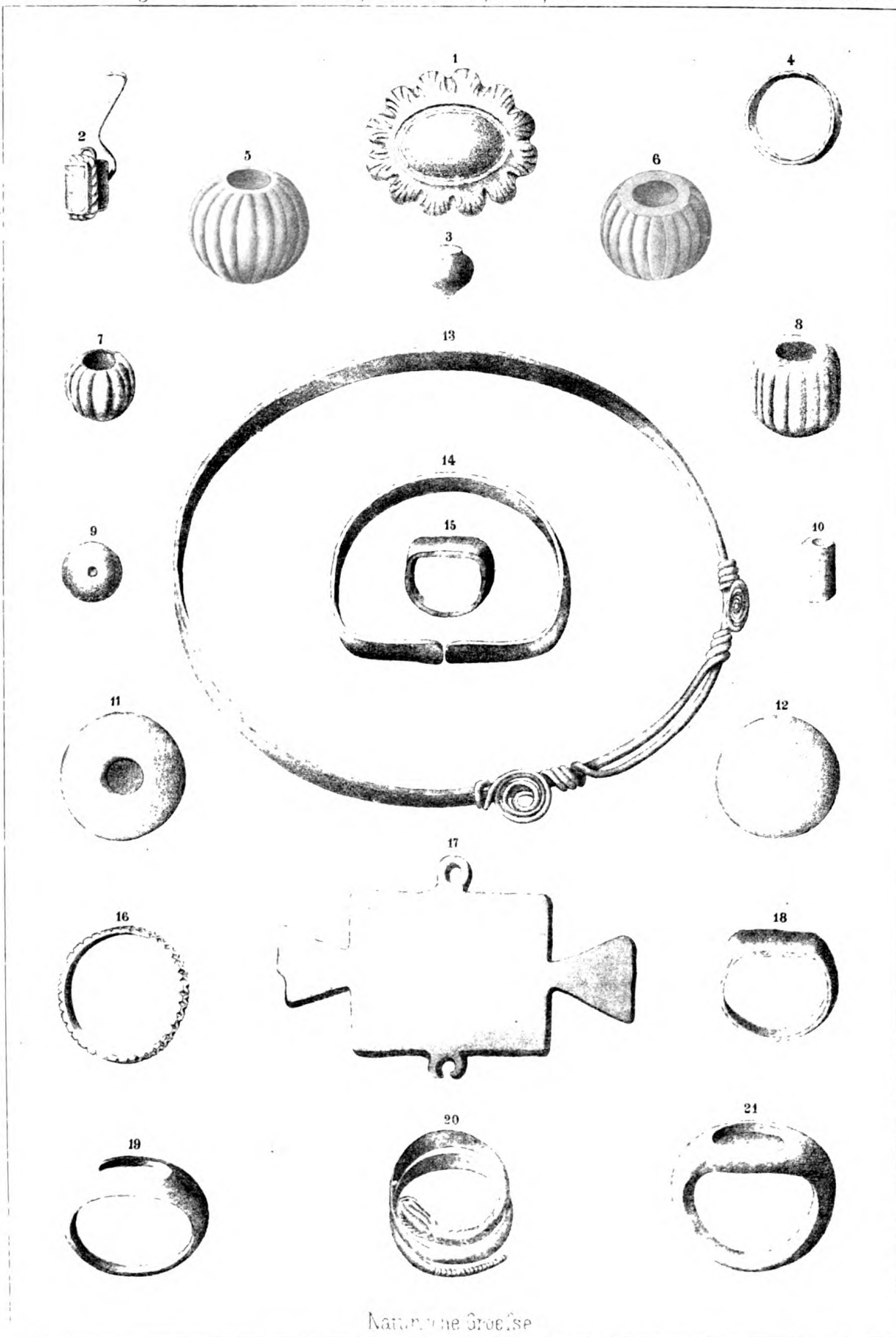

Naturliche Grösse

Saalburg-Museum, Homburg v.d.H.

Abgebildet von ...



VERSCHIEDENES.

Bronze.

TAFEL LXVII.

Die Saalburg.

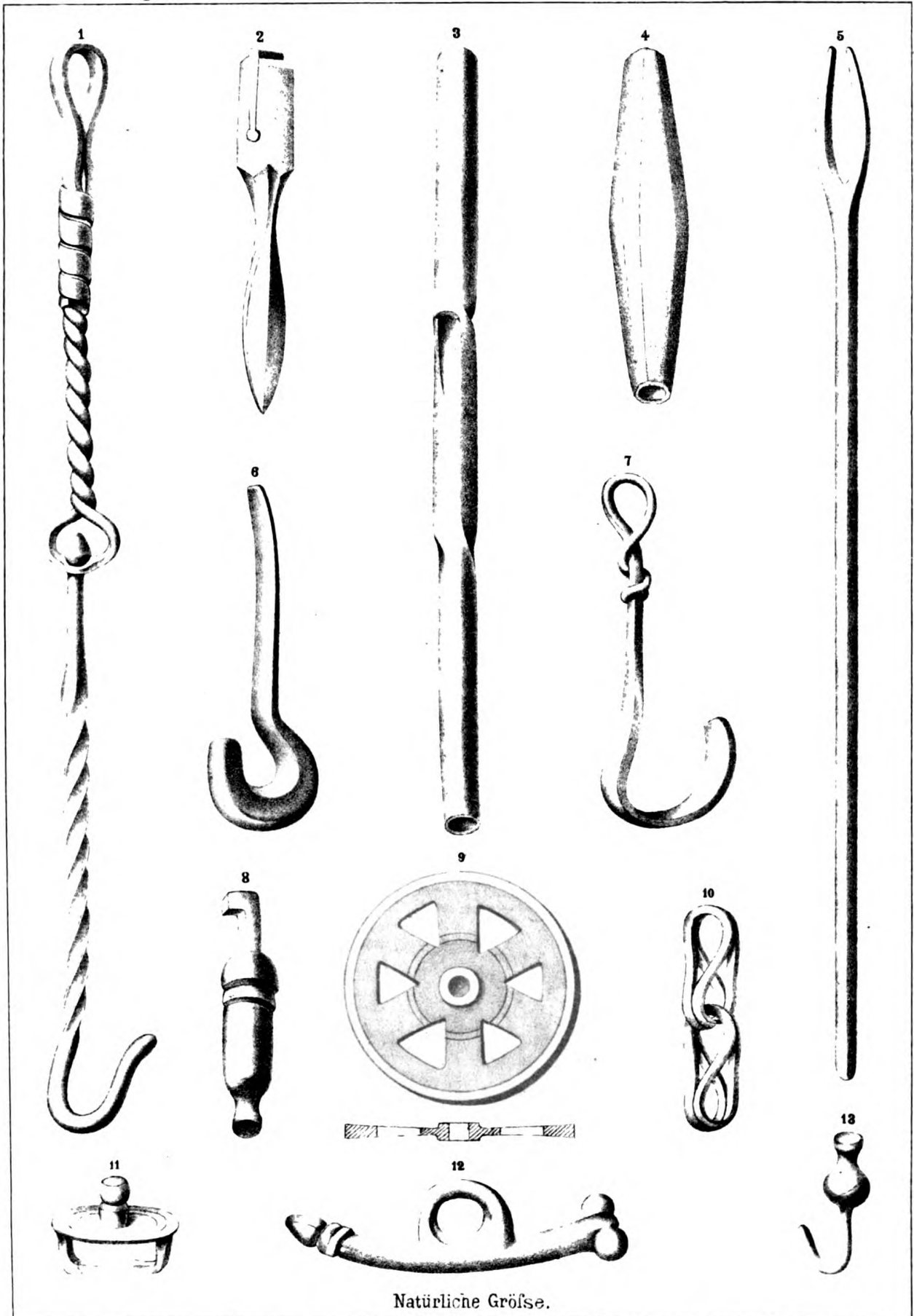

Natürliche Gröfse.

Saalburg-Museum, Homburg v.d.H.

A Pauli, Lith. Anst. Homburg



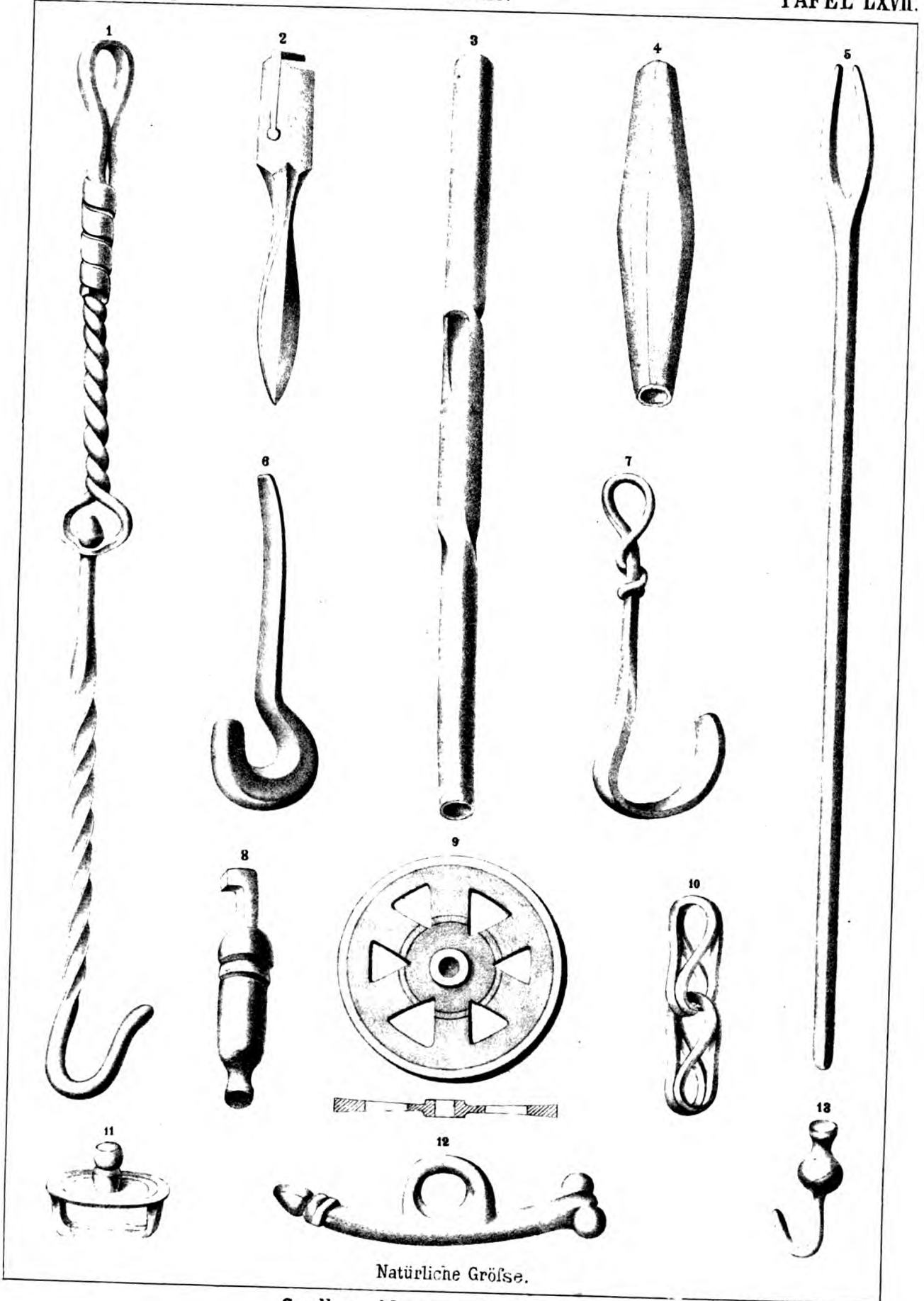

Natürliche Gröfse.

Saalburg-Museum, Homburg v.d.H.







3



1



2



4



5

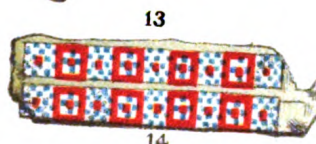

13

14



6

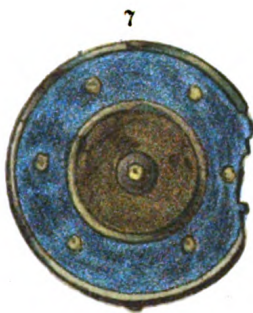

7



8



9



10



15



11



12



Natürliche Grösse.





Natürliche Grösse.



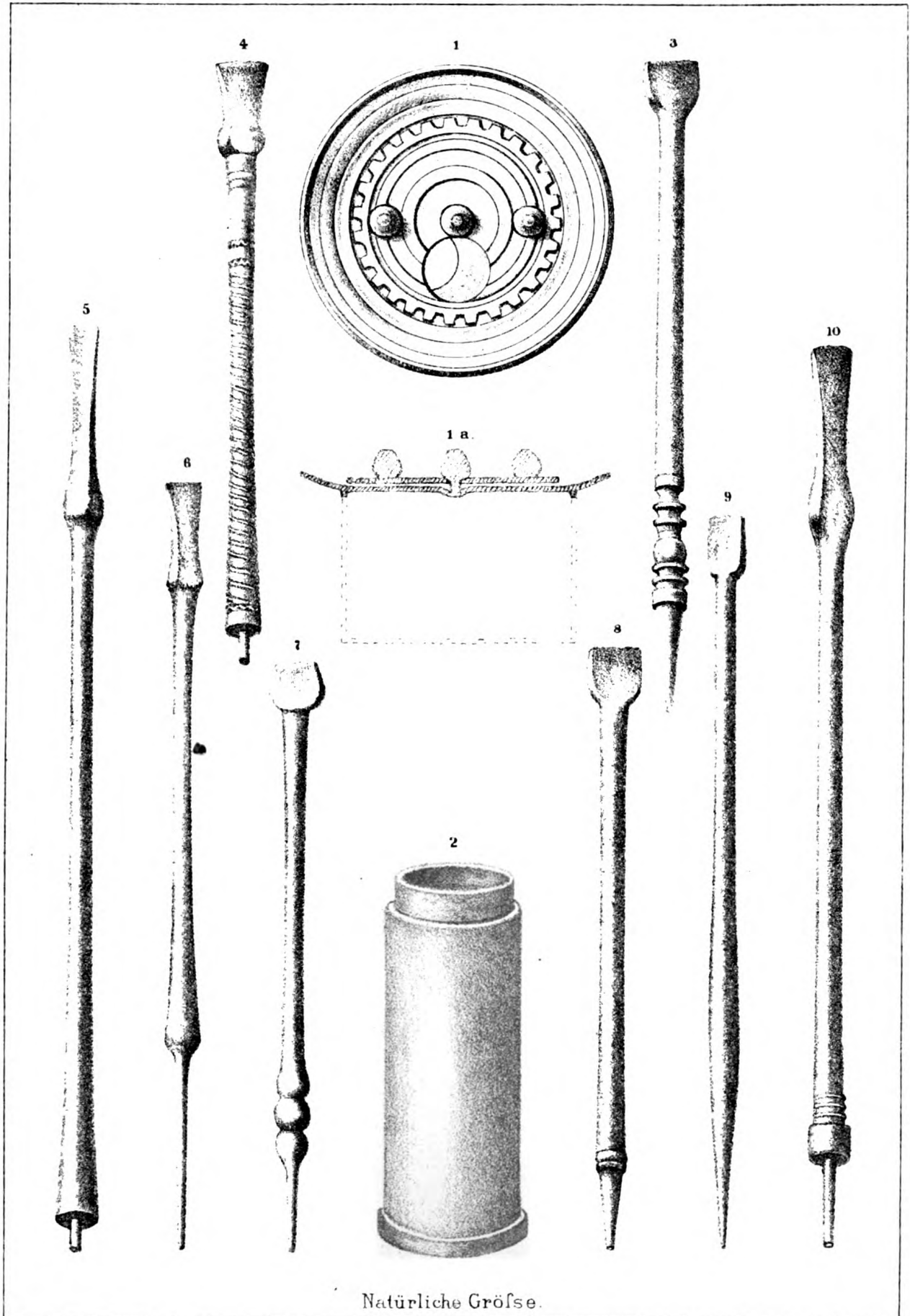

Natürliche Gröfse.

Saalburg-Museum, Homburg v. d.H.

A. Maul Lith. in Leipzig



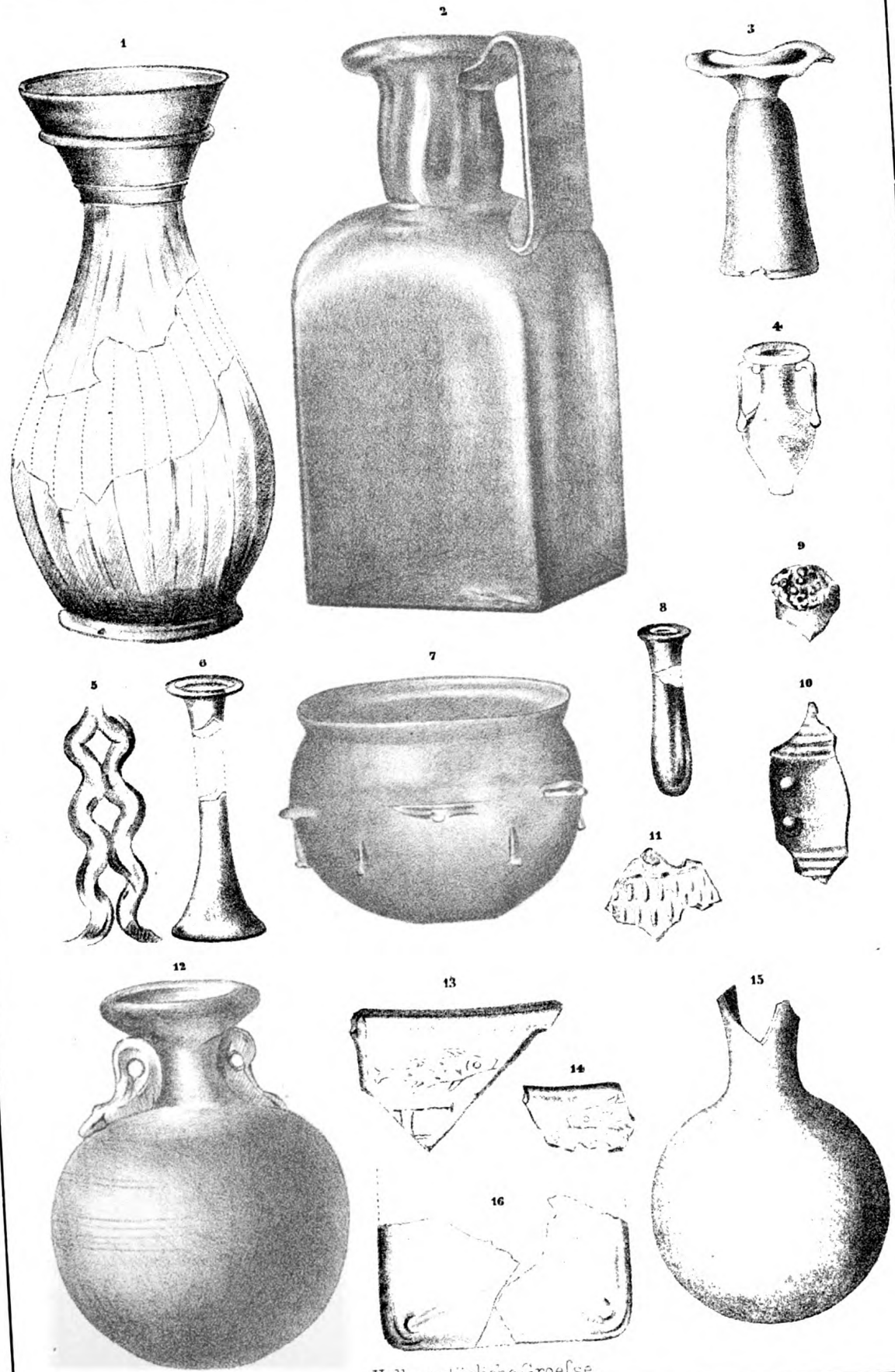

Halbe natürliche Gröesse.

Saalburg-Museum, Homburg v. d. H.

A. Pauli, Lith. Anst. Homburg.





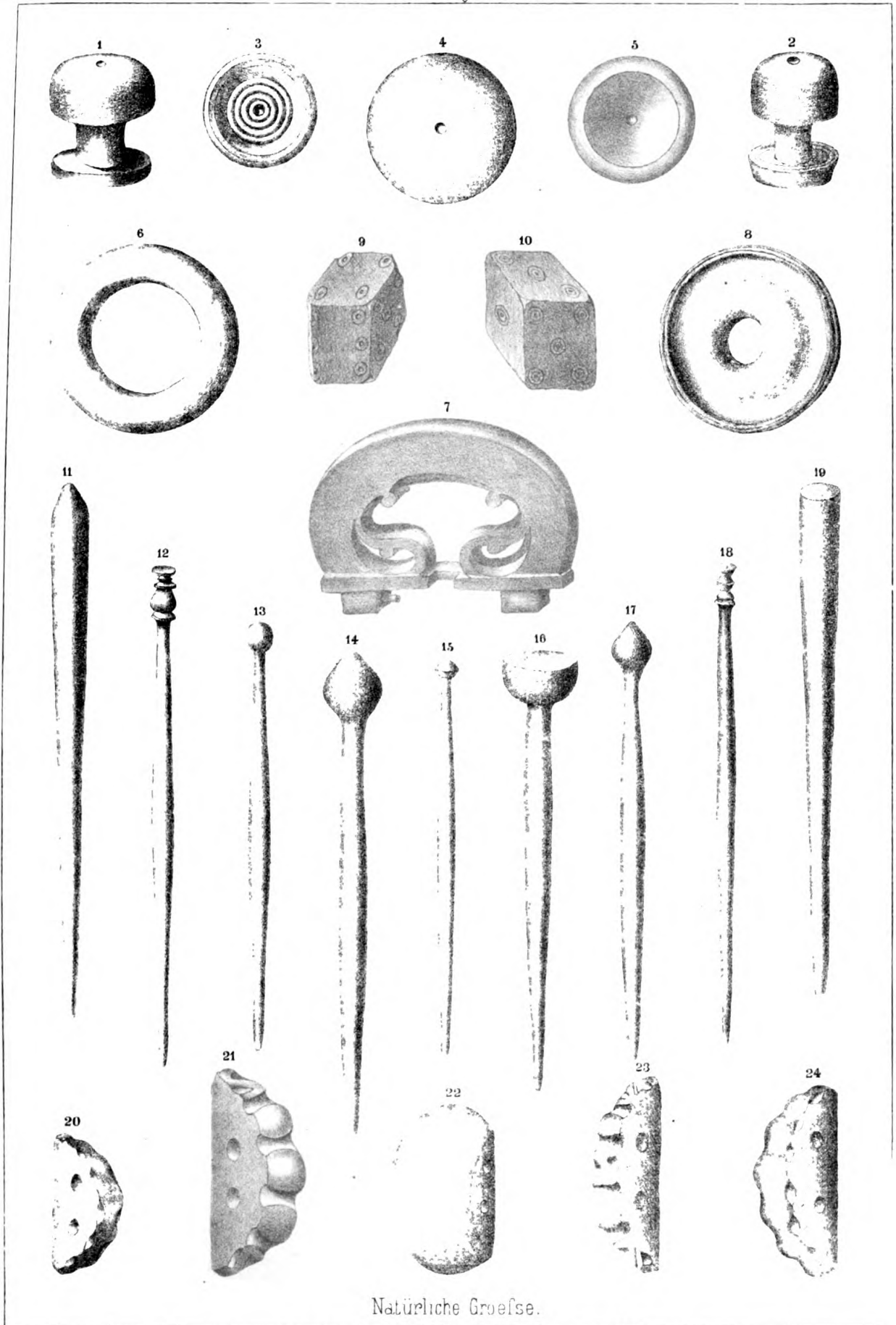

Natürliche Größe.

Saalburg-Museum, Homburg v. d. H.

A. F. v. L. v. Homburg

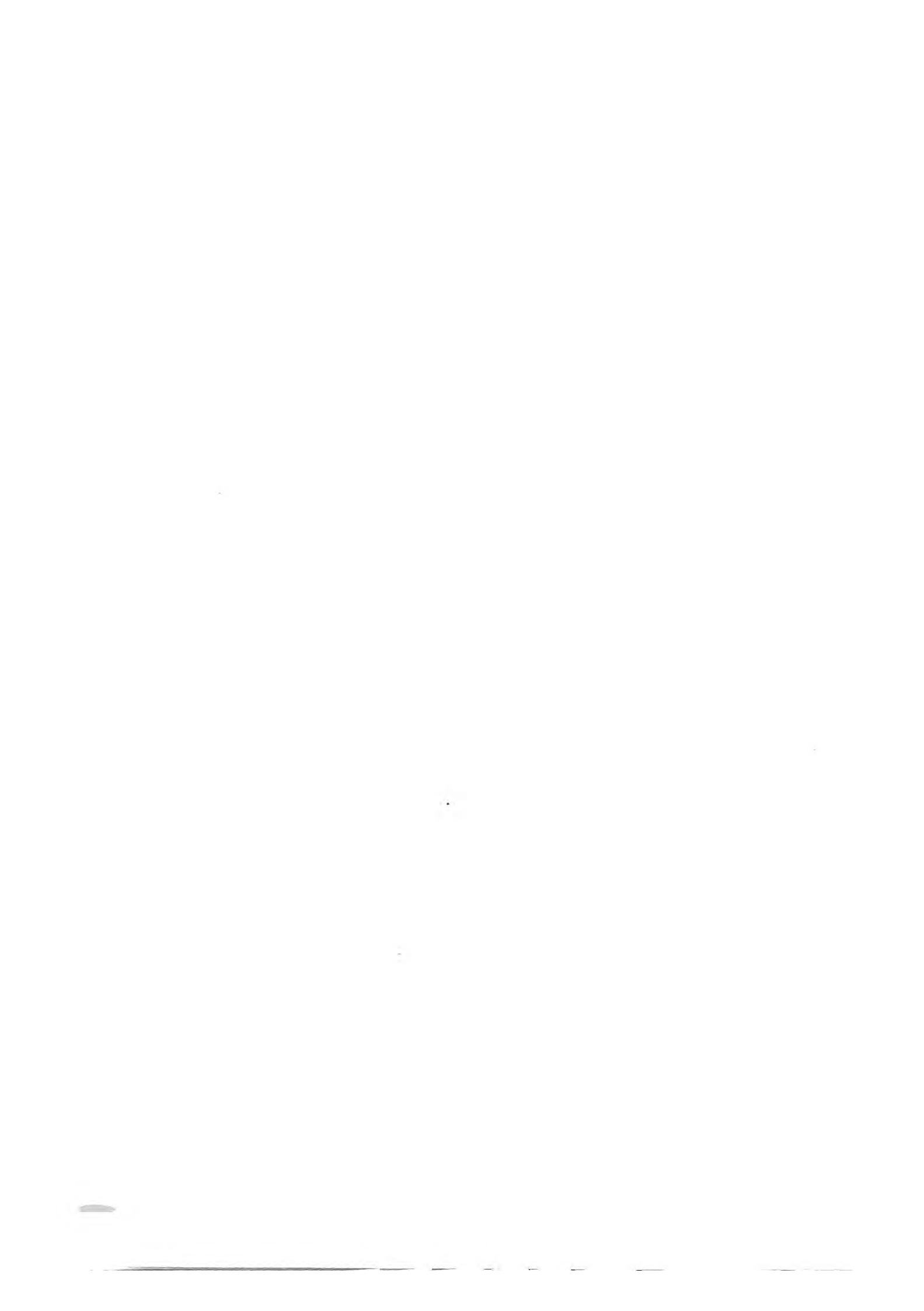

SCHMUCK, KNOEPFE & WUERFEL.

Elfenbein, Gagat & Bein.

Die Saalburg

TAFEL LXXII.

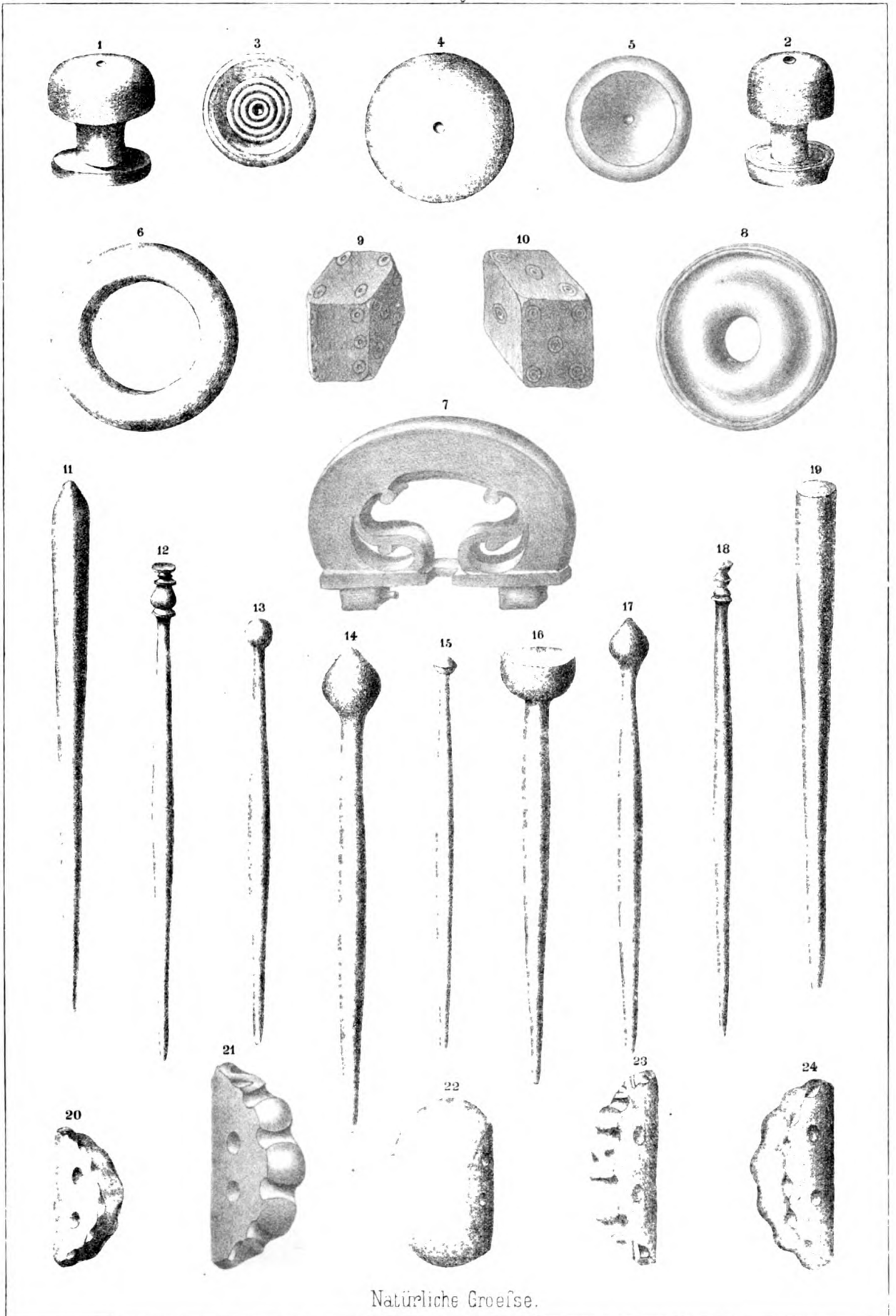

Natürliche Gröfse.

Saalburg-Museum, Homburg v. d. H.



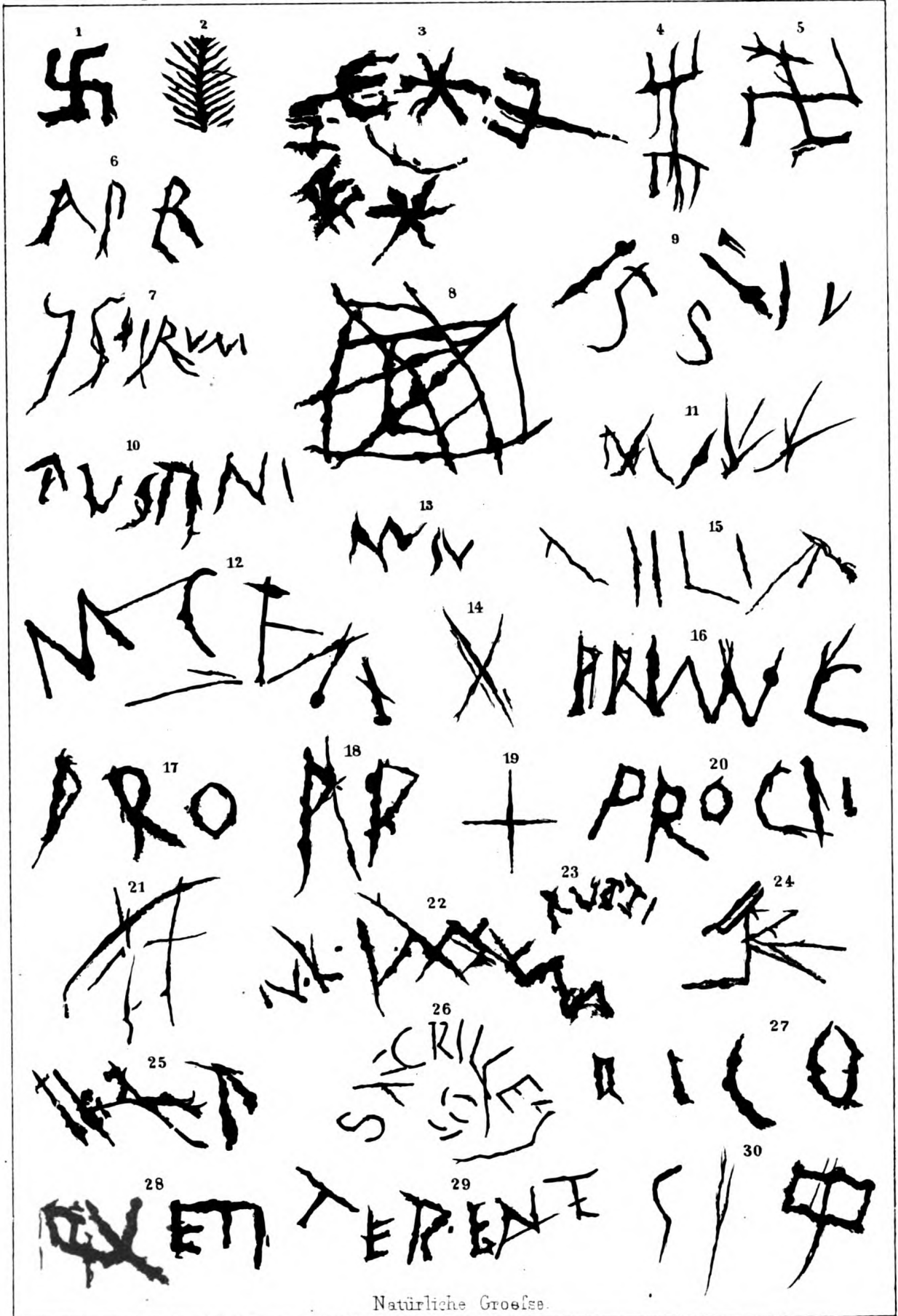

Natürliche Grösse.

Saalburg-Museum, Homburg v. d. H.

A. Pauli Lith. Anst. Homburg



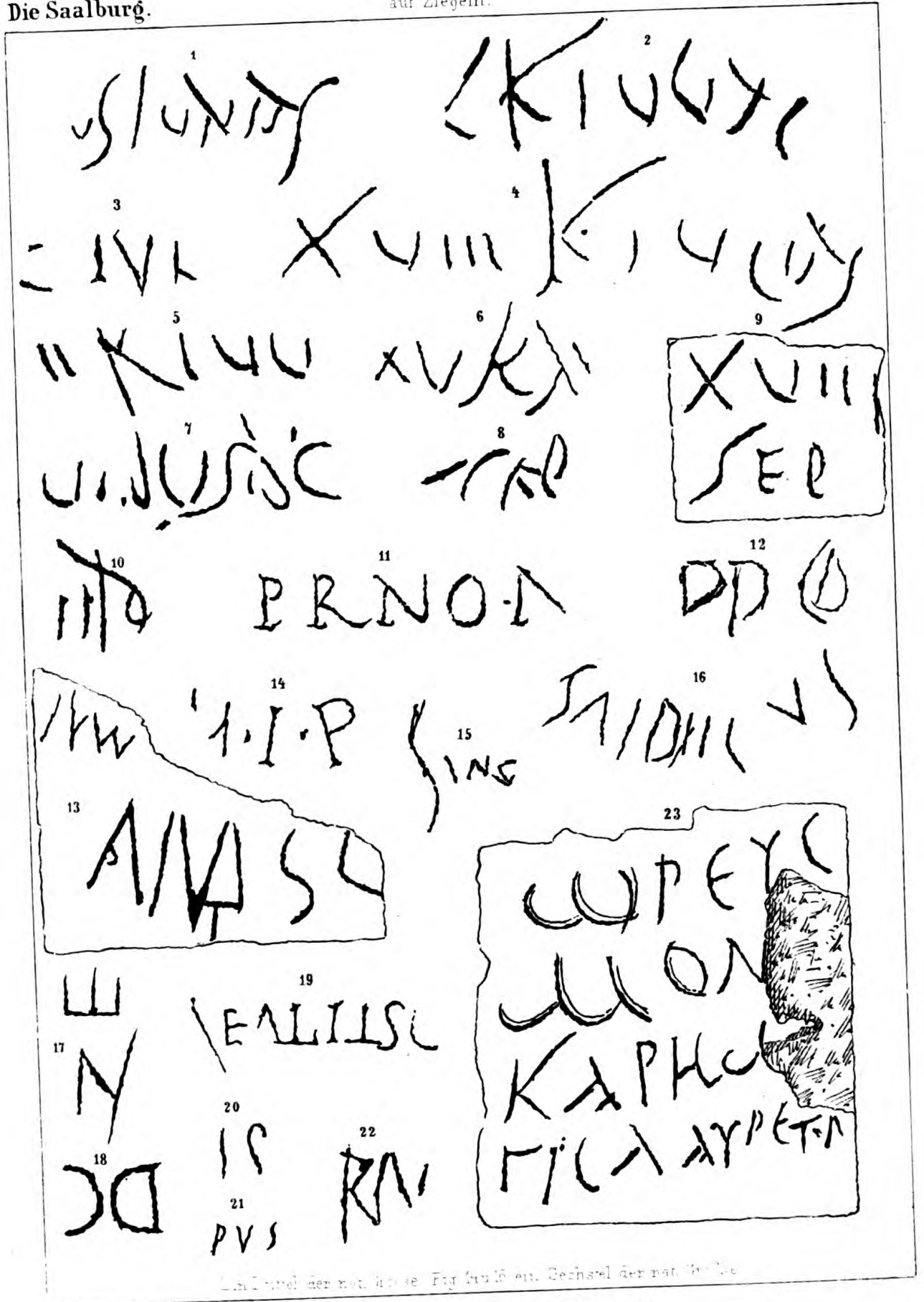

Linienzahl der nat. Größe Fig. (zu 15) ein Sechstel der nat. Größe





ZIEGEL-STEMPEL.

Die Saalburg.

LEG XXII PR P.F.

TAFEL LXXV.

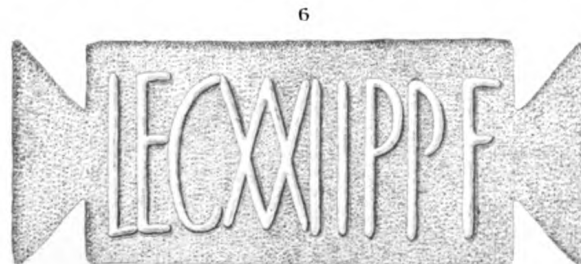
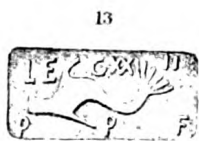
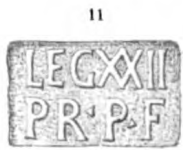
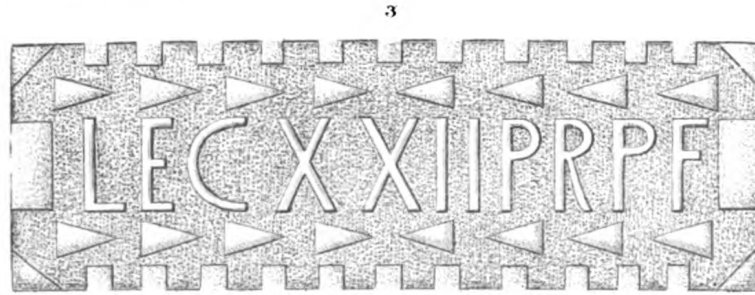
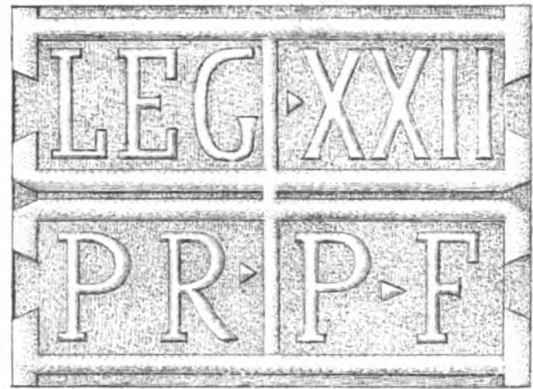
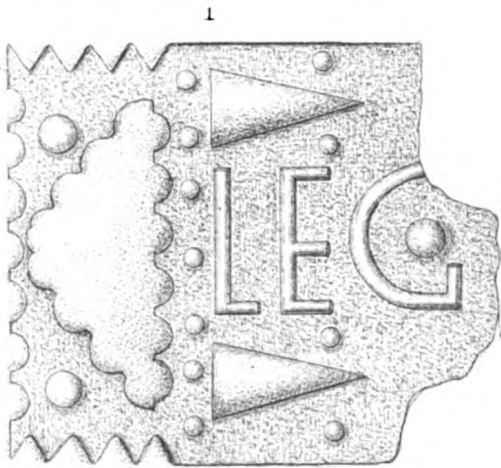

Ein Blatt aus dem Saalburg-Museum.

Saalburg-Museum, Homburg v. d.H.

Verlag des Saalburg-Museums.



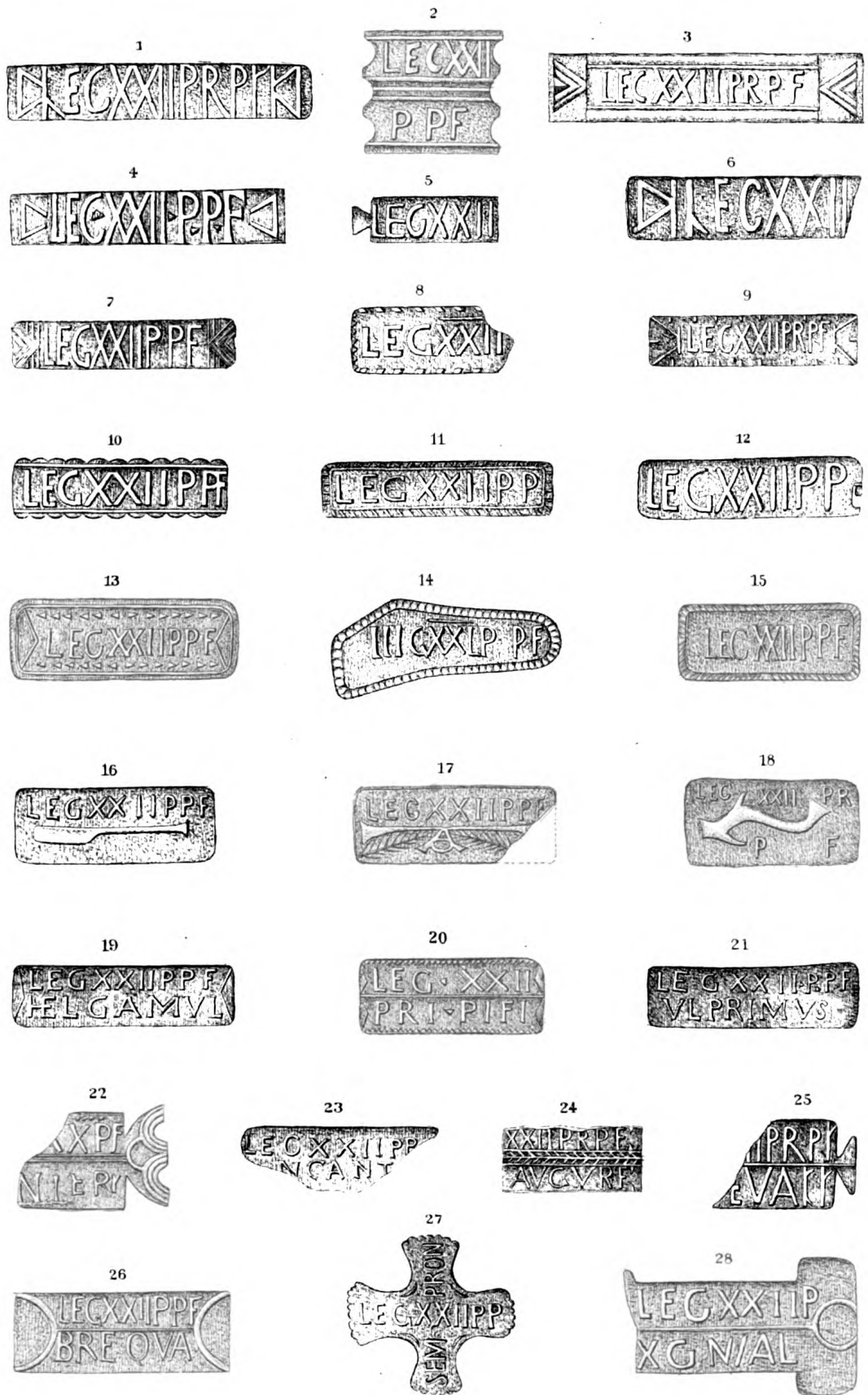

Ein Drittel nat. Größe

Saalburg-Museum, Homburg v. d. H.

A. Pauli Lith. Anst. Homburg.



# ZIEGEL - STEMPEL.

LEG. XXII PR. P.F.

TAFEL LXXVII.

Die Saalburg.

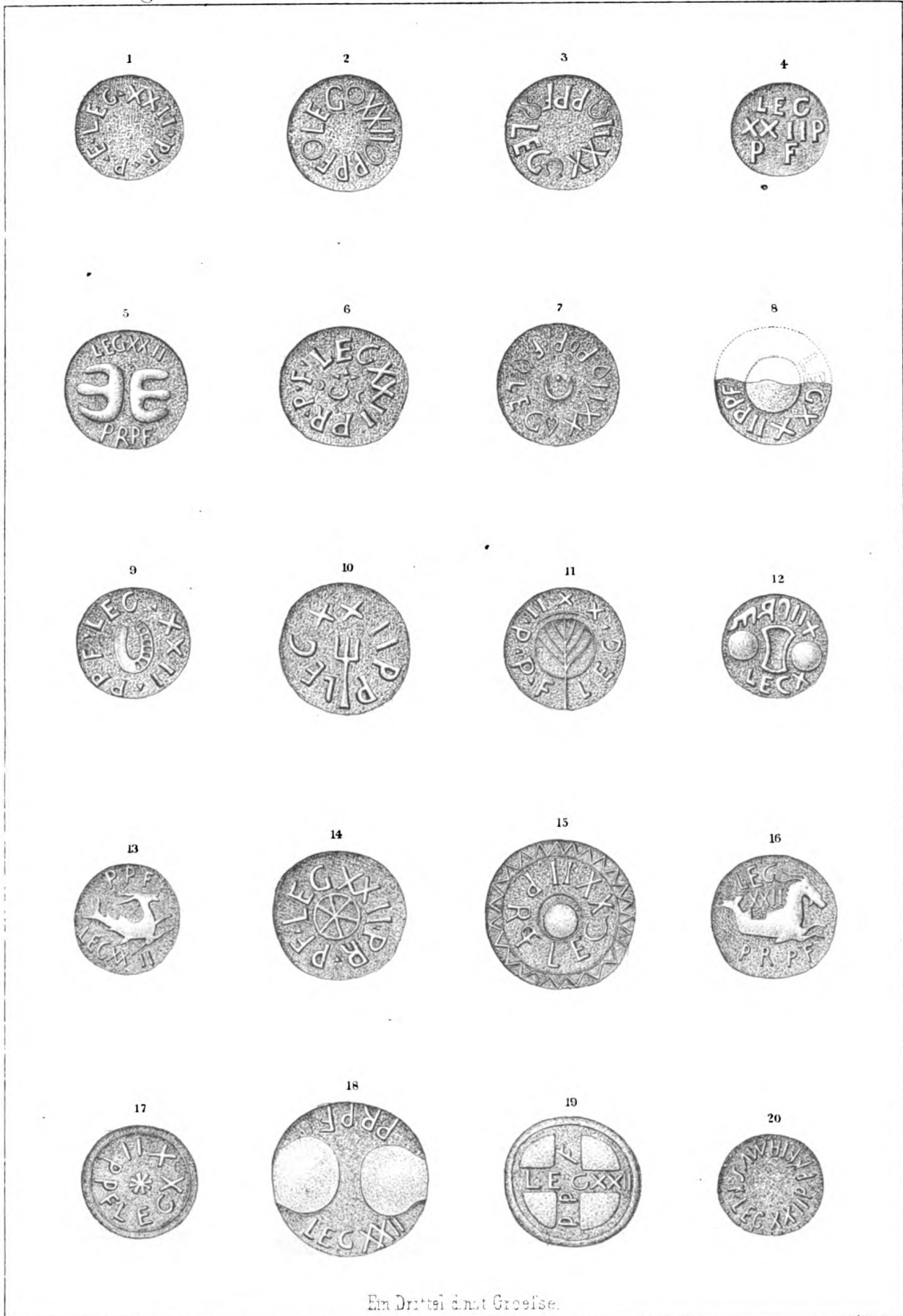

Ein Drittel nat. Gröfse.

Saalburg-Museum, Homburg v. d. H.

A. Pauli Lith. Anst. Homburg



# ZIEGEL - STEMPEL.

Die Saalburg.

LEG-XXII-PR-P-F-LEG-VIII-AUG

TAFEL LXXVIII

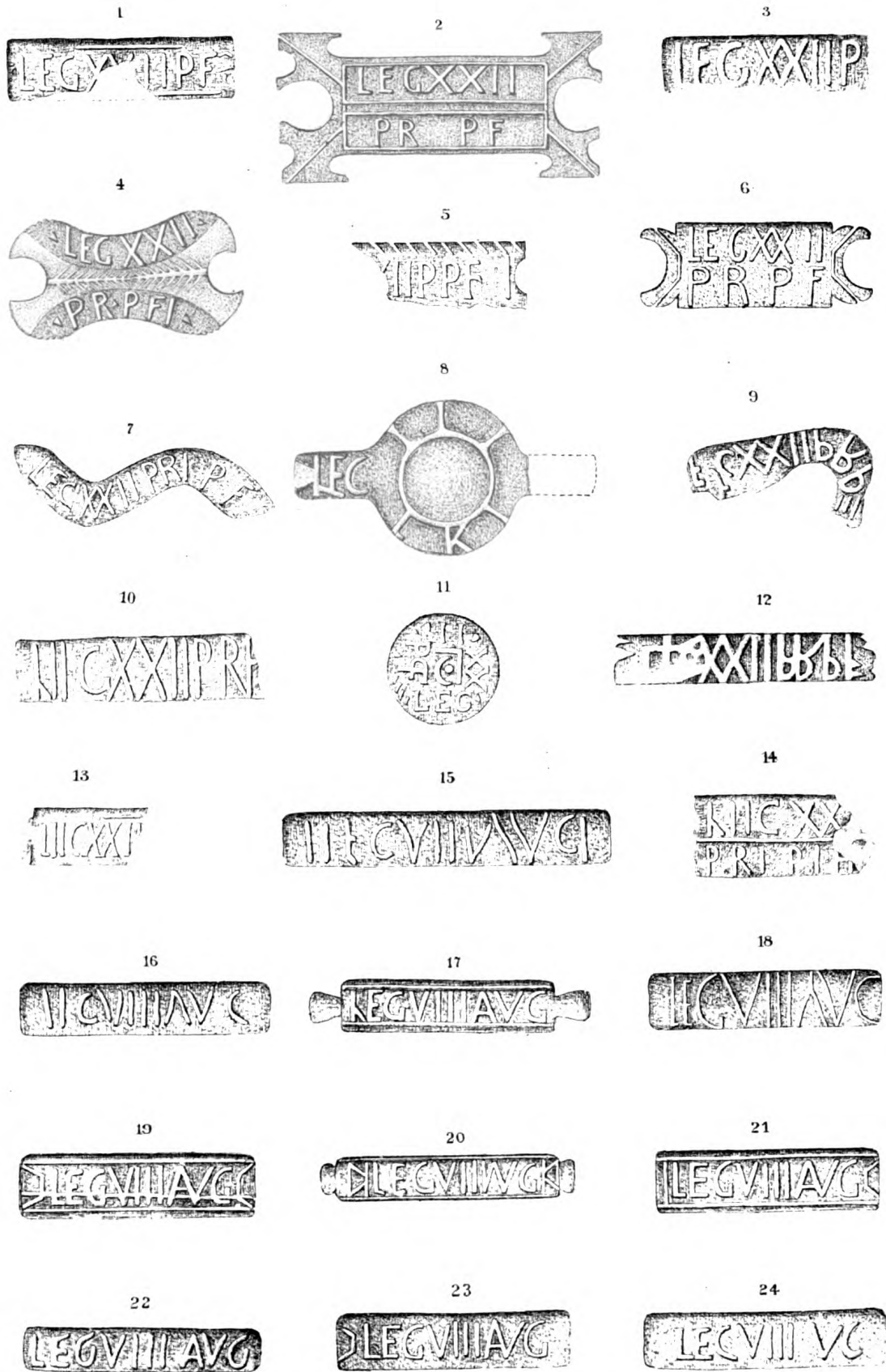

Ein Drittel nat. Größe.

Saalburg-Museum, Homburg v.d.H.

A. Pauli Lith. Anst. Homburg









# GEGENSTAENDE

aus Holz u. Leder

TAFEL LXXX.

Die Saalburg.

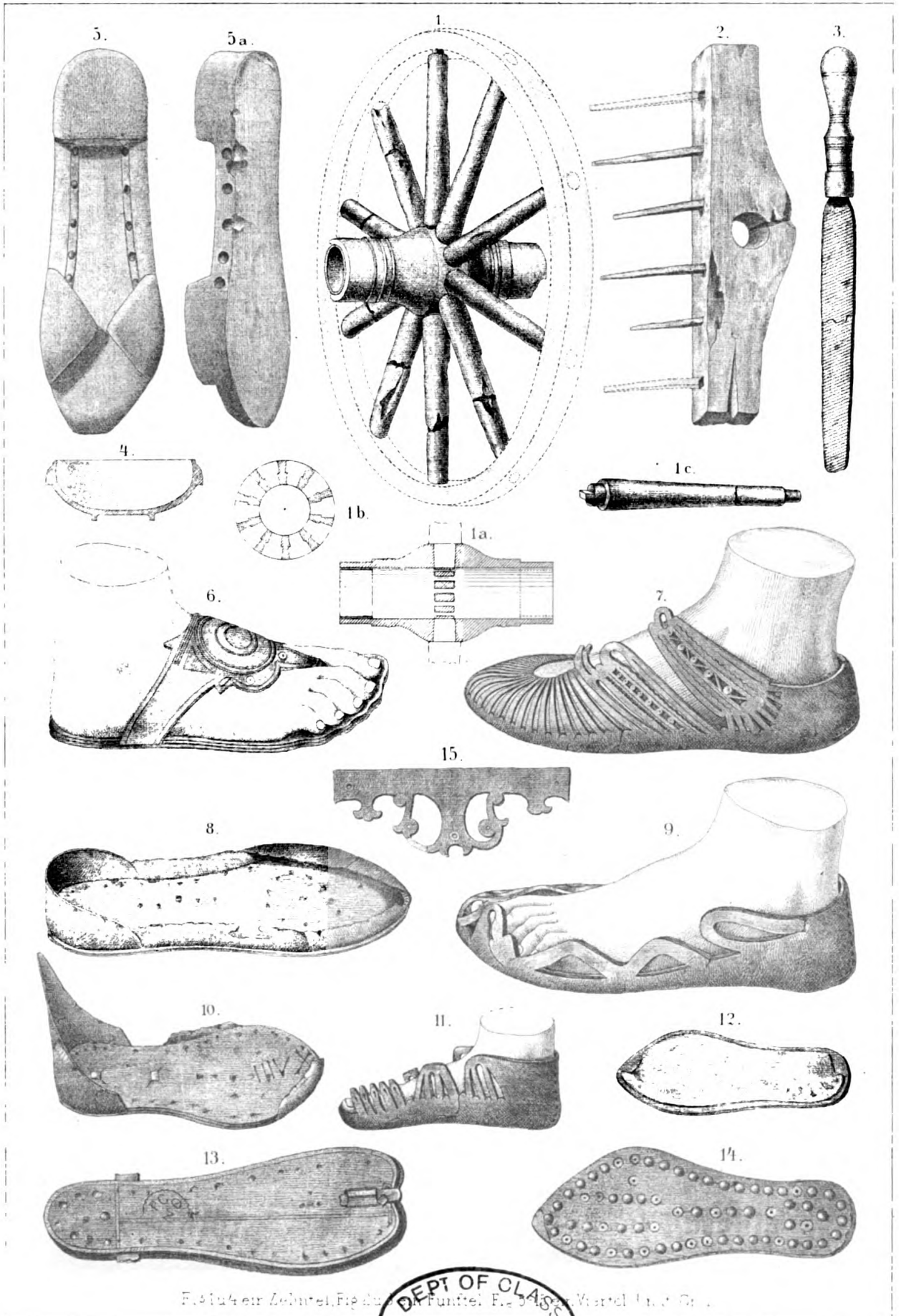

F. 91 u. 4 ein Zehneitel, F. 92 ein Fünftel, F. 93 ein Viertel, F. 94 ein

DEPT OF CLASS  
ARCHAEOLOGY  
OXFORD



\_\_\_\_\_

\_\_\_\_\_

[The page contains extremely faint and illegible text, likely bleed-through from the reverse side of the document. The text is scattered across the page and cannot be transcribed accurately.]

Faint, illegible text at the top of the page, possibly a header or title.





