



# Bodleian Libraries

UNIVERSITY OF OXFORD

This book is part of the collection held by the Bodleian Libraries and scanned by Google, Inc. for the Google Books Library Project.

For more information see:

<http://www.bodleian.ox.ac.uk/dbooks>



This work is licensed under a Creative Commons Attribution-NonCommercial-ShareAlike 2.0 UK: England & Wales (CC BY-NC-SA 2.0) licence.

WEALE'S

FUNDAMENTAL

SERIES

252

*BRICKWORK*

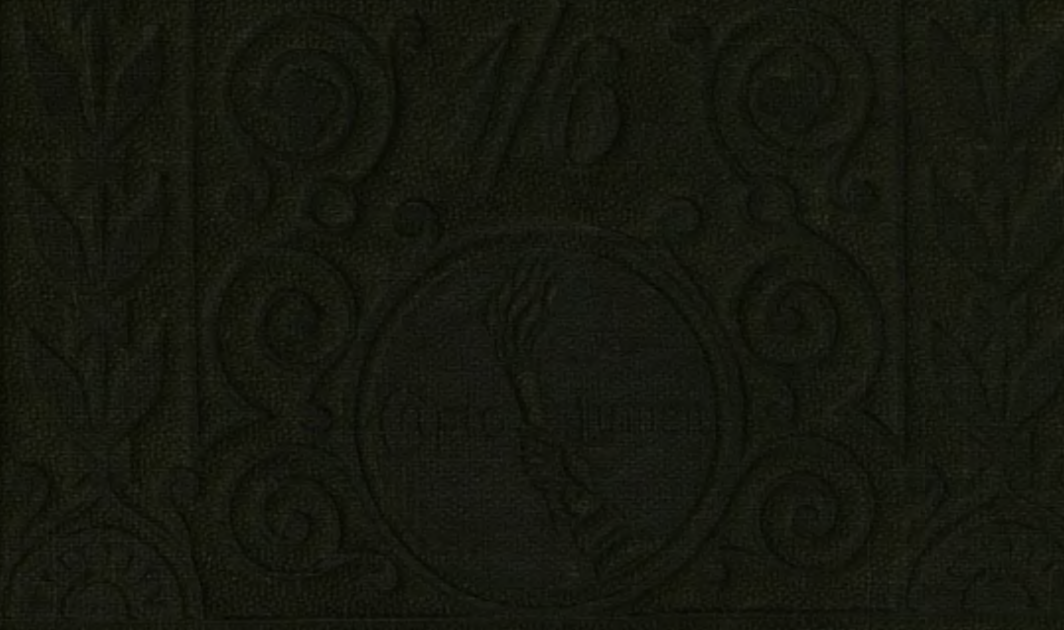

ROSEY LOCKWOOD & CO  
LONDON.

WEALE'S RUDIMENTARY SCIENTIFIC  
AND EDUCATIONAL SERIES.

*The following are the Works already published in*  
**ARCHITECTURE, BUILDING, &c.**

*(The Volumes are bound in limp cloth, except where otherwise stated.)*

**ARCHITECTURE—ORDERS**—The Orders and their  
Æsthetic Principles. By W. H. LEEDS. Illustrated. 1s. 6d.

**ARCHITECTURE—STYLES**—The History and De-  
scription of the Styles of Architecture of various countries, from  
the earliest to the present period. By T. TALBOT BURY, F.R.I.B.A.,  
&c. Illustrated. 2s.

*\*\* The Orders and Styles of Architecture, in one vol., 3s. 6d.*

**ARCHITECTURE—DESIGN**—The Principles of De-  
sign in Architecture, as deducible from Nature and exemplified  
in the works of the Greek and Gothic Architects. By EDWARD  
LACY GARBETT, Architect. Illustrated. 2s. 6d.

*\*\* The three preceding Works, in one vol., half-bound, 6s.*

**VITRUVIUS' ARCHITECTURE.** Translated from the  
Latin by JOSEPH GWILT, F.S.A., F.R.A.S. Plates. 5s.

**GRECIAN ARCHITECTURE**, an Inquiry into the  
Principles of Beauty in. By the EARL OF ABERDEEN. 1s.

*\*\* With "Vitruvius," in one vol., half-bound, 6s.*

**ARCHITECTURAL MODELLING IN PAPER**, the  
Art of. By T. A. RICHARDSON, Architect. Plates. 1s. 6d.

**HINTS TO YOUNG ARCHITECTS.** By GEORGE  
WIGHTWICK. New and Enlarged Edition. By G. HUSKISSON  
GUILLAUME, Architect. 3s. 6d.; cloth boards, 4s.

**A BOOK ON BUILDING**, Civil and Ecclesiastical ;  
including Church Restoration ; with the Theory of Domes and  
the Great Pyramid, and Dimensions of many Churches and other  
Great Buildings. By Sir EDMUND BECKETT, Bart., LL.D., Q.C.,  
F.R.A.S. Second Edition, enlarged, 4s. 6d. ; cloth boards, 5s.

**THE ART OF BUILDING**, Rudiments of. General  
Principles of Construction, Materials used in Building, Strength  
and Use of Materials, Working Drawings, Specifications, and  
Estimates. By EDWARD DOBSON, M.R.I.B.A., &c. Illustrated.  
2s. ; cloth boards, 2s. 6d.

**COTTAGE BUILDING ; or, Hints for Improved Dwell-**  
ings for the Labouring Classes. By C. BRUCE ALLEN, Architect.  
Illustrated. New Edition, 1s. 6d.

**DWELLING-HOUSES**, a Rudimentary Treatise on  
the Erection of, illustrated by a Perspective View, Plans, Eleva-  
tions, and Sections of a pair of semi-detached Villas, with the  
Specification, Quotations, &c. By S. H. BROOKS,  
Architect. New Edition, 3s. 6d. ; cloth boards, 3s.

CROSBY LOCKWOOD

15, N. B. COURT, E.C.

A SELECTION FROM WEALE'S SERIES.

- WARMING AND VENTILATION*; being a Concise Exposition of the General Principles of the Art of Warming and Ventilating Domestic and Public Buildings, Mines, Lighthouses, Ships, &c. By CHARLES TOMLINSON, F.R.S., &c. Illustrated.
- THE ACOUSTICS OF PUBLIC BUILDINGS.* By T. ROGER SMITH, M.R.I.B.A., Architect. Illustrated. 1s. 6d.
- FOUNDATIONS AND CONCRETE WORKS.* By E. DOBSON, M.R.I.B.A., &c. 1s. 6d.
- ARCHES, PIERS, BUTTRESSES, &c.*: Experimental Essays on the Principles of their Construction, for the use of the Practical Builder. By W. BLAND. 1s. 6d.
- THE BLASTING AND QUARRYING OF STONE* for Building and other purposes, and on the Blowing up of Bridges. By Gen. Sir JOHN BURGOYNE, Bart., K.C.B. 1s. 6d.
- LIMES, CEMENTS, MORTARS, CONCRETE MASTICS, PLASTERING, &c.* By G. R. BURNELL, C.E. 1s. 6d.
- PORTLAND CEMENT FOR USERS.* By HENRY FAIJA, Assoc. M. Inst. C.E. Second Edition, corrected. 2s.
- MASONRY AND STONECUTTING*, Rudimentary Treatise on; in which the Principles of Masonic Projection and their application to the construction of Curved Wing-Wall Domes, Oblique Bridges, and Roman and Gothic Vaulting, are concisely explained. By EDWARD DOBSON, M.R.I.B.A., &c. Illustrated with Plates and Diagrams. 2s. 6d.; cloth boards, 3s.
- THE RUDIMENTS OF PRACTICAL BRICK LAYING.* By ADAM HAMMOND. Fourth Edition. Illustrated with 68 Woodcuts. 1s. 6d.
- BUILDING ESTATES*: a Rudimentary Treatise on the Development, Sale, Purchase, and General Management of Building Land, including the Formation of Streets and Sewers and the Requirements of Sanitary Authorities. By FOWLTON MAITLAND, Surveyor. Illustrated. 2s.
- SANITARY WORK IN THE SMALLER TOWNS AND IN VILLAGES.* Comprising:—1. Some of the most Common Forms of Nuisance and their Remedies; 2. Drainage; 3. Water Supply. By CHARLES SLAGG, Assoc. M. Inst. C.E. Second Edition, revised and enlarged. 3s.; cloth boards, 3s. 6d.
- PLUMBING*: a Text-book to the Practice of the Art or Craft of the Plumber. With Chapters upon House Drainage embodying the latest improvements. By W. P. BUCHAN, Sanitary Engineer. Fourth Edition, revised and much enlarged. With 330 Illustrations. 3s. 6d.; cloth boards, 4s.
- HOUSE PAINTING, GRAINING, MARBLING AND SIGN WRITING*: a Practical Manual of. With Coloured Plates of Woods and Marbles, and nearly 150 Wood Engravings. By ELLIS A. DAVIDSON. Fourth Edition, 5s.; cloth boards, 6s.

CROSBY LOCKWOOD & CO., 7, STATIONERS' HALL COURT, E

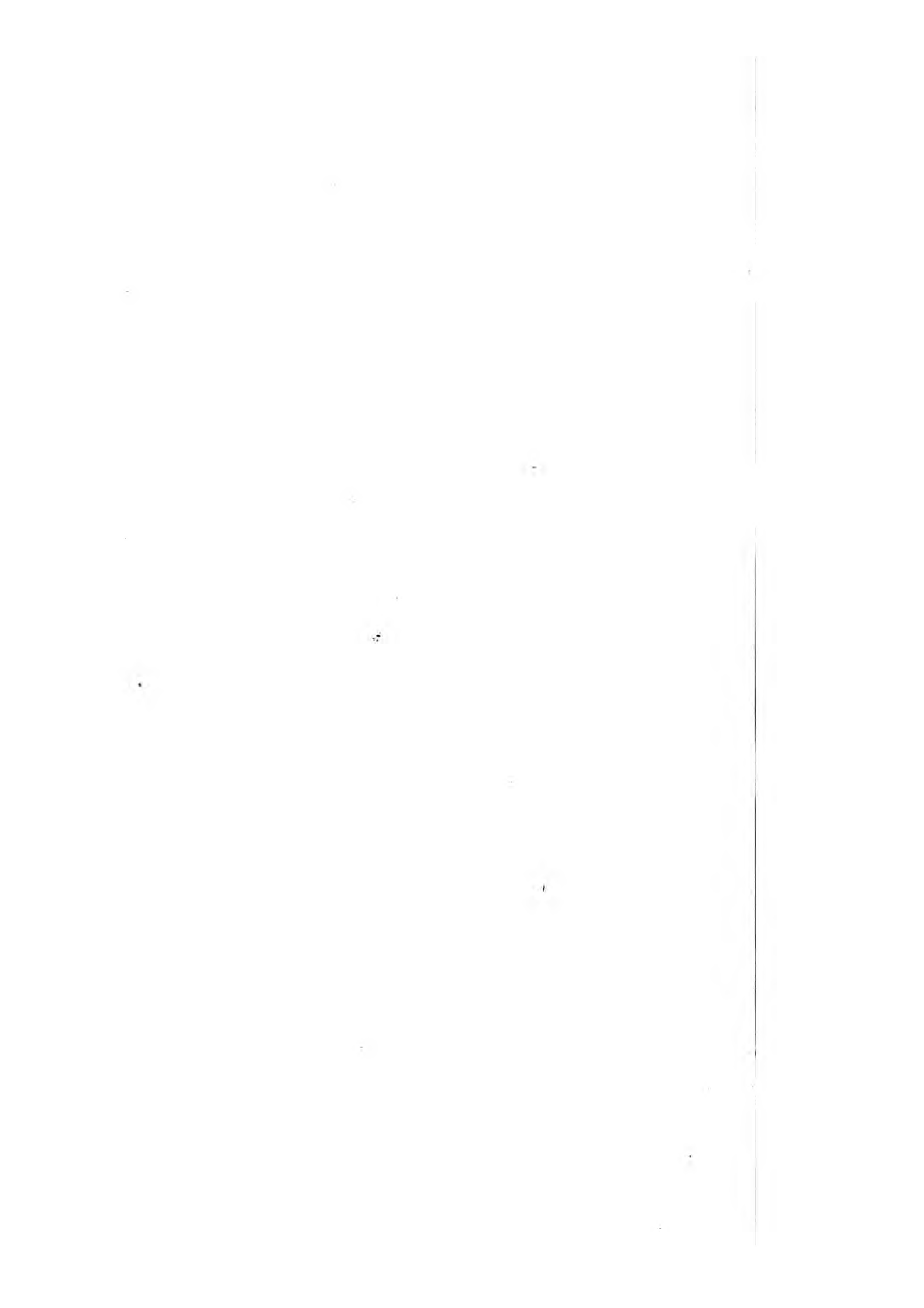

# BRICKWORK

## *A PRACTICAL TREATISE*

EMBODYING THE GENERAL AND HIGHER PRINCIPLES OF  
BRICKLAYING, CUTTING, AND SETTING

WITH

THE APPLICATION OF GEOMETRY TO ROOF TILING,  
REMARKS ON THE DIFFERENT KINDS OF POINTING,  
A DESCRIPTION OF THE MATERIALS USED BY THE BRICKLAYER

AND

A SERIES OF PROBLEMS IN APPLIED GEOMETRY

By F. WALKER

CERTIFICATED BY THE SCIENCE AND ART DEPARTMENT IN BUILDING CONSTRUCTION,  
SOLID GEOMETRY, ETC., ETC.

*ILLUSTRATED WITH NINETY-ONE WOODCUTS*



LONDON  
CROSBY LOCKWOOD AND CO.  
7, STATIONERS' HALL COURT, LUDGATE HILL  
1885

[*All rights reserved.*]

179 e. 1.

LONDON:  
PRINTED BY J. S. VIRTUE AND CO., LIMITED,  
CITY ROAD.



## PREFACE.

---

THE object of this little work is to give the young artisan a general and practical insight into his trade, and to inspire him with a wish to become a useful and successful workman; which means that he must work with his head as well as with his hands. The greater portion of the matter contained herein is such as to be indispensable to the proficient workman. Though the work does not profess to be in any way an exhaustive treatise on a trade so varied as that of the bricklayer, yet the writer hopes that it may be a help to those who, through the division of labour or otherwise, have had their practice confined to one branch only of their trade; and that it may not be considered altogether unworthy the notice of professional men, being to some extent the outcome of twenty-two years of practical experience in building operations. It is, however, intended



chiefly for that large majority of young men who enter the trade of the bricklayer (and all other trades in house-building) without any previous training or instruction to fit them for the calling, depending entirely upon the manipulative skill they may or may *not* acquire in the handling of their tools. The book commences with the site of a building, and goes through the successive stages of the bricklayer's trade, including roof tiling; and concludes with a section on Applied Geometry, containing problems that may be useful in every-day practice.

LONDON, *September*, 1884.

# CONTENTS.



## SECTION I.

### MATERIALS AND GENERAL PRINCIPLES OF CONSTRUCTION.

	PAGE
Site . . . . .	1
Establishing a Level or Datum . . . . .	2
Setting out Building . . . . .	2
Concrete . . . . .	5
Cement . . . . .	8
Drains . . . . .	10
Mortar . . . . .	12
Red Brickwork . . . . .	13
Bricks . . . . .	14
Characteristics of good Bricks . . . . .	17
Bond of Brickwork . . . . .	18
Old English Bond . . . . .	18
Bond of Footings and Walls . . . . .	19
Setting out the Bond . . . . .	23
Heading Bond . . . . .	26
Templates and Strings . . . . .	27
Bats . . . . .	27
Flemish Bond . . . . .	28
Various Bonds . . . . .	31
Herring-bone Bond . . . . .	33
Dutch Bond . . . . .	34

	PAGE
Keeping the Perpend . . . . .	36
Toothings . . . . .	36
Grouting . . . . .	37
Flues . . . . .	38

---

## SECTION II.

## ARCHES IN GENERAL.

Arches . . . . .	43
Relieving Arches . . . . .	45
Plain Arches . . . . .	46
The Skew or Oblique Arch . . . . .	46
Skew Arch at Brondesbury . . . . .	49
Water Conduits . . . . .	53
Groined Vaulting . . . . .	55

---

## SECTION III.

## GAUGED-WORK AND ARCH-CUTTING.

Gauged Work . . . . .	58
Setting . . . . .	60
Drawing and Cutting Arches . . . . .	61
The Bulls-eye . . . . .	61
Semi and Segmental Arches . . . . .	63
The Camber Arch . . . . .	64
The Gothic Arch . . . . .	66
The Ellipse Gothic Arch . . . . .	68
The Semi-Ellipse Arch . . . . .	69
The Venetian Arch . . . . .	70
The Scheme Arch . . . . .	71
The Semi-Gothic Arch . . . . .	72
Gothic on Circle Arch . . . . .	73
To Find the Soffit Mould . . . . .	74

## SECTION IV.

## ORNAMENTAL BRICKWORK.

	PAGE
The Niche . . . . .	75
The Niche Mould . . . . .	79
Moulded Courses . . . . .	79
Ornamental Arches . . . . .	80
The Oriel Window . . . . .	81
Ornamental Gable or Pediment . . . . .	83
Gothic Window . . . . .	84

---

## SECTION V.

## ROOF-TILING, POINTING, ETC.

Tiling . . . . .	88
Roofs having different Pitches . . . . .	90
To obtain the necessary Angle of Hip or Valley Tiles . . . . .	92
Pointing . . . . .	93
Flat-Joint Pointing . . . . .	94
Burning Clay into Ballast . . . . .	96
Building Additions to Old Work . . . . .	98
Fire-proof Floors . . . . .	98

---

## SECTION VI.

## APPLIED GEOMETRY.

To draw a square whose superficial area shall equal the sum of two squares whose sides are given . . . . .	99
To draw a right-angled triangle, base $1\frac{1}{2}$ inches, height $\frac{1}{2}$ inch . . . . .	100
To draw an arc by cross-sectional lines . . . . .	101
To describe a flat arc (camber for instance) by mechanical means . . . . .	102

	PAGE
To find the joints of a flat arch without using the centre of the circle of which the arc is a part . . . .	102
To draw the joints of a semi-ellipse arch with mathemati- cal accuracy . . . . .	103
To find the invisible arch contained in a camber . . . .	104
Any two straight lines given to determine a curve by which they shall be connected . . . . .	105
To find the form or curvature of a raking moulding that shall unite correctly with a level one . . . . .	107
To describe an ellipse by means of a carpenter's square and a piece of notched lath . . . . .	108
To draw a Gothic of any given height and span, an Ellipse Gothic . . . . .	109
To draw the arch bricks of a Gothic arch . . . . .	110
To find the radius of any arc or arch, the rise and span being given . . . . .	110

# BRICKWORK.

---

## SECTION I.

### MATERIALS AND GENERAL PRINCIPLES OF CONSTRUCTION.

#### SITE.

THOUGH the bricklayer is very seldom called upon to choose the site of a proposed building, he should nevertheless make himself acquainted with the essentials of a good foundation, and the characteristics of a bad one, as a subject not altogether foreign to his calling. The workman who rests satisfied with just the manipulative knowledge of his own trade is not likely to realise the value of the word *progress*, and must of necessity be content to remain in the position in which he found himself placed as a workman. Though the bricklayer has no voice in the choice of site, he may, as foreman or clerk of works, have to a great extent the power of minimising the evil effects of a bad one, if he be possessed of the necessary knowledge. For be it remembered that a good foundation is as necessary to the stability of a building, as good flues and drains are to the health and comfort of its occupants. The best sites to build upon are hard gravel, igneous and

metamorphic rocks, limestones, sandstones, and chalk. A clay foundation should be well drained, as clay by its impervious nature retains moisture, and the whole area of the site covered with 6 inches of surface concrete, made up with Portland cement or ground blue lias lime, to keep back ground-damp, which will be attracted by the warm air within the building. When building on a clay or sand foundation the building should be kept level throughout, as by building up one portion of the building and leaving down another, ugly fractures sometimes occur in the walls, caused by one portion of the work settling at one time, and other portions at another, which greatly mar the appearance of the structure.

#### ESTABLISHING A LEVEL OR DATUM.

Before excavating trenches to receive concrete for footings, a level, or *datum* as it is technically called, should be established. To do this, drive a large stake well into the ground where it will not be likely to get disturbed, and let the top of it be the ground-floor level, which must be taken off the drawings if not otherwise determined. To avoid the possibility of mistakes, all levels for excavations, concrete, and brickwork should be taken from this only.

#### SETTING OUT BUILDING.

In setting out a building, one or other of the following methods is generally adopted. Either the extreme side walls are squared from

the line of frontage, which is given, and the positions of the intermediate walls established by parallels; or, two centre lines are drawn at right angles, right through the plan of the building, and the walls set out at parallel distances from them; taking all measurements from the centre lines. The positions of walls should not be laid down by measuring the distance of one wall from another in succession; for if an error be made in the setting out of the first wall, it will, in this way, be perpetuated from one wall to another throughout the building. But by measuring from the centre line, an error would be confined to that particular wall in connection with which it was made. In both methods we have assumed the building to be square. If the setting out is to be done by means of a large square, which is generally the case, it should be tested or proved before use.

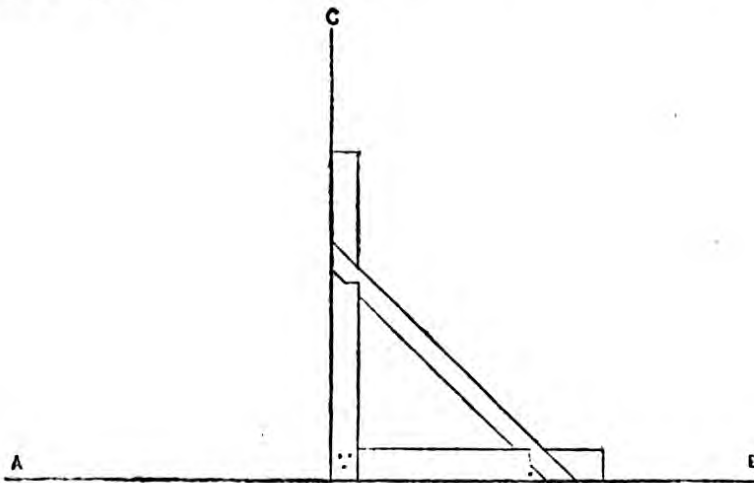

Fig. 1.

To do this, draw a line  $a b$  along a straight edge (Fig. 1), not less than twice the length of



the base of the square. Adjust the base of the square along this line from *b*, and draw a line *c* along the perpendicular blade until it meets the base line *a b*; now reverse the square along the base line from *a*, and if the square be true its perpendicular will coincide with the perpendicular line *c*. Another way of setting out the side walls from a given line of frontage is by means of a 10-foot rod. Having drawn a line tightly to represent the front of the building, along this line measure 6 feet from the quoin (French *coin*, a corner), and push through the line at the 6-foot point an ordinary brass pin. Draw another line in the same way as the first, approximately at right angles to it, and from the quoin again measure off 8 feet along *this* line, fixing another pin as before at the 8-foot point.

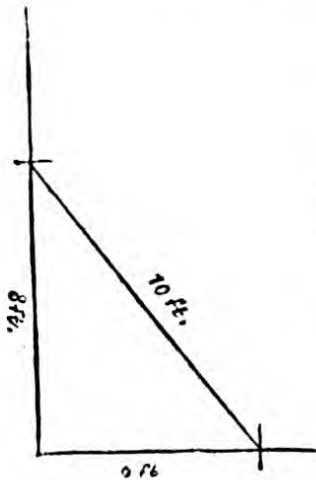

Fig. 2.

With one end fixed at the quoin, the other end of the line must be moved until there be a distance of 10 feet between the two pins measured across the angle. The lines will then be square one with the other. Instead of 6, 8, and 10, we could have taken 12, 16, and 20; but whatever figures be used must stand in the same ratio or proportion to each other as the above, and shown in Fig. 2.

*Another Method.*—From point B (Fig. 3), with measuring tape set off 30 feet, or more or less

as convenient, at an approximate angle of 45 degrees with the given line A B. From D mea-

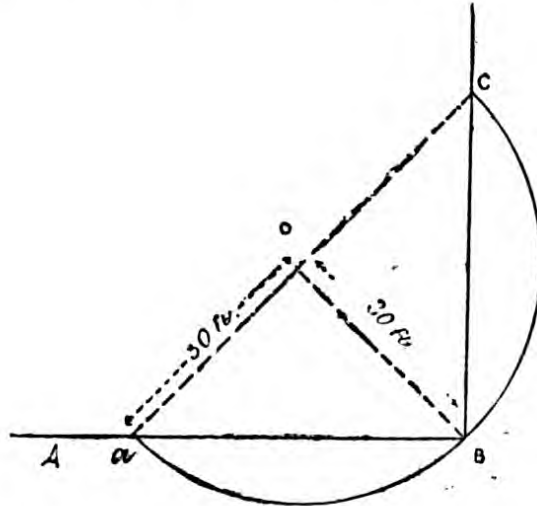

Fig. 3.

sure off the same distance to *a*; from *a* draw a line through *D*, measuring from *D* to *c* 30 feet. A line drawn from *B* through *c* will be at right angles to the given line A B, the line of frontage; *B* would be the quoin of building. This depends upon the principle that all triangles in a semicircle are right-angled triangles, and all the angles in the same segment of a circle are equal (*Euclid*, bk. iii. prob. 21).

### CONCRETE.

The thickness for concrete varies from 1 to 3 feet, according to the nature of the subsoil upon which the building will stand; but in some cases it is very much thicker, as in made-up ground, where, to ensure a good foundation, it is necessary to go down to the London clay, or some other firm

substratum, depending upon the nature of the ground. The concrete must not be less than 9 inches in depth, nor have a margin of less than 4 inches outside the first course of footings; 6 inches is the usual margin in good work.

The following is a specification to govern the supply of materials, the mixing, and the putting into place of cement concrete. The whole of the cement to be Portland of the very best quality, very finely ground, weighing not less than 110 lbs. to the striked bushel, of which 80 per cent. must pass through a sieve of 2,500 meshes to the square inch, and it must be capable of maintaining a breaking weight of 350 lbs. per square inch, after being made in a bronze mould immersed in water during an interval of seven days.

The mixing to be carried on upon a clean platform made of 9 inch  $\times$  3 inch deals, bedded solidly on sand, that the cement may not run off through the joints in the process of mixing. The concrete to be composed of four parts of broken bricks, broken porous stone, or Thames ballast; two parts sharp clean sand, free from loam or other impurities; and one of cement of the specified quality. The parts to be measured in a half-yard cubic box (3 feet  $\times$  2 feet  $\times$   $2\frac{1}{4}$  feet), and thoroughly mixed together in a dry state. The ballast or broken bricks to be capable of passing through a 2-inch mesh. The dry concrete to be heaped up and turned over at least twice before wetting. The water to be applied through a rose, not more to be used than is necessary to mix the whole very

thoroughly. While the water is being sprinkled on, the mixture should be drawn down by "picks," while two or more other men turn it over, after being so drawn down, to another part of the platform, from which it must be again turned over until the parts are thoroughly incorporated. The concrete to be tipped from a height not exceeding 4 feet, and to be steadily rammed or struck with the back of a shovel until the cement or matrix flushes to the surface. The whole to be left solid and clean.

In Portland cement concrete, "a rotten or friable material is to be avoided, except where unavoidable, and in that case only in combination with a large quantity of cement, so as to neutralise as far as possible any tendency to weakness. Sand, where a choice exists, should be as rough and coarse as possible, and that made by the various natural or physical influences from sandstone, limestone, or other similar rocky formations, is to be preferred over those from flint or volcanic rocks. The former sands or shingles are more porous than the latter, and consequently better able to absorb the silicates of the cement when being mixed. For this reason it is advisable not to have the sand, gravel, or shingle too fully saturated with water; if this is so, the matrix is unable to imbibe the fluid portion of the mixture, and consequently it is thrown off as waste from the concrete. This observation equally applies to the mischievous practice of over-wetting bricks in building with cement mortar. A dry brick is

bad enough, but when saturation is carried to excess equally faulty results ensue. With regard to the acting properties of Portland cement when used with salt sand, or salt water, an experiment proved the use of salt water and salt sand perfectly satisfactory, both with Portland cement and lias lime, but there was no question as to their setting being retarded by their use."—*Brunel*.

When blue lias is used for concrete, the proportion of parts and the mixing is the same as described in cement concrete.

Burnt ballast is frequently used as an aggregate for concrete, but care should be taken that it be thoroughly burnt free from clay. Burnt ballast concrete should be made rather sloppy on account of its absorbent nature, or it will quickly absorb the moisture from the cement or lime with which it is mixed, to the injury of its setting properties and ultimate strength.

Mixed with one-third of Thames ballast and a fair proportion of lime it will yield a good concrete.

#### CEMENT.

Adie's No. 1 cement testing machine is very generally used for testing cements, but where one



Fig. 4.

of these is not at hand they may be roughly tested in the following manner. Having mounted a briquette (Fig. 4), whose sectional area is one square inch, or more as the case may be, after seven days' immersion let it be suspended from one

end, and from the other end suspend a cement barrel containing sand, increasing the quantity until the briquette breaks or its power of resistance be overcome. The sand should not be thrown into the barrel, but slid into it by means of an inclined plane, and in small quantities. The weight of the cask with its contents will represent the breaking weight. With Adie's machine the briquette in the making is subjected to a slight pressure, which adds considerably to its tensile strength, so that the resistance to breaking of a briquette made by the machine will be greater

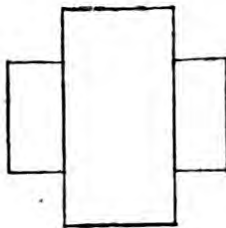

Fig. 5.

than that of a briquette of the same cement made by hand and not subjected to pressure. Another way: bed two bricks together (Fig. 5), and after a few days' immersion let them be suspended and treated in the same way as the briquette. This plan is suitable for ascertaining the comparative strength of cements, but in so doing the same kind of bricks, sand (if any used), and even water should be used, and the exact proportions maintained in the mixing, or, in other words, the conditions should be exactly the same. Bricks having a smooth impervious bed will be found to have less adhesion than those of a hard but comparatively porous nature—pressed bricks and hard stocks, for instance.

The bricklayer should make himself acquainted with the various limes and cements, and the ingredients used in combination with them; also

with concrete, as subjects belonging particularly to his trade, and which by reason of his occupation he has a better opportunity of doing than any other class of operatives. In large and important public works these are generally subject to the inspection of a bricklayer.

#### DRAINS.

The laying of drains, at once the most important and too frequently the most neglected part of a building, should never be intrusted to unskilled workmen. The fall having been determined, which should not be less than one in sixty or one inch in five feet, the flange of each pipe should rest upon a bedded brick, that the joints may be caulked all round with gaskin or oakum previously to being made up with Portland cement. The object of caulking is to prevent the cement squeezing through into the pipe, a very common cause of stoppage in drains. They can now be bedded half way up in fine concrete, so as to form a cradle, care being taken not to disturb the joints. The drains should be laid down air and water-tight, free from "dips," with no right-angled junctions nor sharp bends, and kept, if at all possible, outside the building, with inspection holes large enough for a man to work forcing-rods in case of a stoppage. A length of pipe in the man-hole should have a movable top. This kind of pipe is called an *operculum* or "channel" pipe. In many instances only the invert half of the pipe is used

in that portion of the drain passing through the man-hole, which is ventilated by a current of fresh air entering the man-hole, passing through the entire length of the drains, and finding an outlet through the open soil-pipe above the roof. In such an arrangement a trap should intervene between the sewer and the man-hole, to prevent

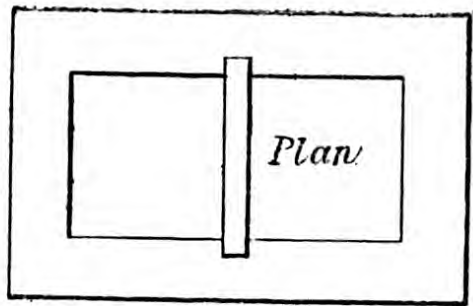

Fig. 6.

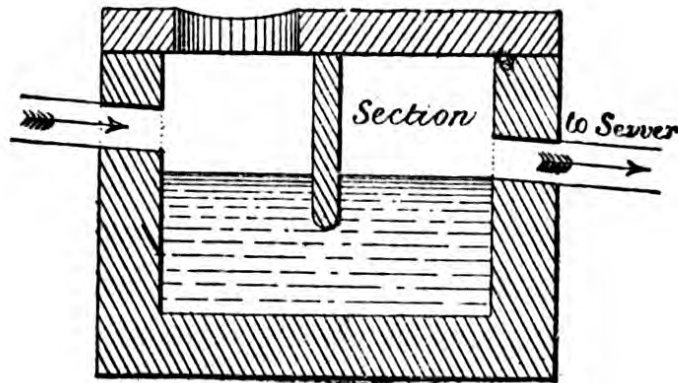

Fig. 7.

the possibility of sewer gas escaping through the fresh air inlet. But where fresh air is not introduced, the trap may be dispensed with, the soil-pipe serving as a ventilator both for the sewer and the drains.

Six-inch pipes will be found large enough for most buildings. As trapping, disconnecting, and



ventilating drains belong to sanitary science, it cannot be further noticed here beyond giving a plan and section of a dip-trap (Figs. 6 and 7) which the bricklayer is sometimes called upon to build. This trap should be used only where there is a copious and frequent supply of water (but not in connection with soil), as by its size and construction a greater quantity of water is required to trap it than the earthenware traps now more generally and preferably used.

#### MORTAR.

Mortar used by the bricklayer is made either from stone lime, lias, or Portland cement, mixed with a proper proportion of sand. Chalk lime should not be used, as the only setting that takes place in it is the formation of a surface crust, bearing a small proportion to the bulk. Stone, or gray chalk lime, as it is sometimes called, is generally used; it possesses slight hydraulic power, and will set hard if secluded from the air or in damp situations, and is capable of bearing three parts of sand to one of lime. For damp situations blue lias will be found to make the best mortar. It is eminently hydraulic, and becomes very hard, especially in damp places; but it will not bear so much sand as stone lime. The amount of sand should not exceed twice that of lime. Lump lias is used for mortar; it should be well wetted, covered over with sand, and allowed a day to slack before being ground in the mortar mill. The sand used for all mortars

should be a clean, sharp, angular grit. Cement has been already spoken of in connection with concrete, and elsewhere.

### RED BRICKWORK.

Owing to the revival of the Queen Anne style of architecture, brickwork now occupies the foremost position in building construction, of which very good samples may be seen at Westwood House, Sydenham; Fitz-John Avenue, Hampstead; the Chelsea Embankment, and many other places in and about London. Our popular architects delight to revel and indulge their fancies in red brickwork, as evidenced in several public buildings of recent erection. The Victorian age, from an architectural point of view, will be conspicuous for its stuccoed buildings and its red brickwork—the former a lie and a cheat, a lifeless and soulless imitation, the vile offspring of the speculator, and the Caliban of architecture. But Truth in architecture, as in all things, *will* assert herself; she breathes into the nostrils of a second Adam, and lo! we have “a thing of beauty.”

“It is to be regretted that plastering with cement, a practice which is more to the interest of the brickmaker and the speculating builder than to the consumer, has become so prevalent in this country. These tradesmen thus get rid of their worst bricks, which are hidden by a coat of plaster, the building soon decaying when the heart of the wall is bad. Colour seems to be the

objectionable quality about this material, the commonplace architect forgetting that form is much more essential to beauty than colour. In the time of Jones and Wren red brick was beautifully wrought into architectural forms, of which a few examples still remain in the metropolis; and by Palladio bricks were occasionally used for columns without smearing them over with plaster."—*Gwilt*.

### BRICKS.

In dealing with brickwork it is necessary that something should be said about bricks, though it is not intended to go into the chemical properties or other scientific matters connected with them, as we are presumably writing for persons in or connected with the trade of a bricklayer, but will just take a passing glance at the bricks commonly used in and about London, and state the purposes for which they are best adapted.

Stock bricks are divided into "picked" stocks (picked for colour and hardness), "washed" stocks, "grizzles," "place," and "shuffs." "Shuffs" are worthless, "place" are little better; "grizzles" are those bricks which have a good face or end with the other face or end underburnt, and similar in appearance to "place," which are of a reddish colour. "Picked" are those which are suitable for good exterior facing. "Washed" stocks, on account of their softness, are fit only for interior facing. The best stock bricks for general facing purposes are those called

“shippers,” which, as their name implies, are sorted for shipping.

Malms are a superior kind of stock bricks, made of washed clay and chalk, and are used for superior facing and for “cutting” purposes, but are not suitable for “gauged-work” on account of the numerous small air-cells contained in the bricks, which make it impossible to rub them up to an arris, which is indispensable to good setting.

Of red building bricks there are a great variety in the London market, the best of which for colour and weathering properties are Fareham reds. They are very irregular in shape. Fareham rubbers for “gauged-work” also stand first in quality, though they are not extensively used, as they are dearer than the other varieties in the market.

Next in quality come the Berkshire Builders and T. L. B. Rubbers, made by T. Lawrance, Bracknell, Berks. The Teynham bricks, stamped G. Richardson, Teynham, are good bricks, possessing in a large degree the qualities that recommend the Farehams, and with the additional advantage of a fairly good shape. Gault bricks are much used for facing; they are much harder than stocks, and also dearer. Of white bricks Suffolks are the very best. They are a close, firm brick, suitable for first-class facing, either exterior or interior, or for “gauged-work.” They are of a soft nature, but harden very much by exposure to the action of the atmosphere.

A very nice piece of work—three-light geometrical windows—executed in these bricks, and designed by Messrs. H. Saxon Snell and Sons, 22, Southampton Buildings, W.C., may be seen in the chapel attached to the Rackham Street Infirmary, Notting Hill, W. Staffordshire blue bricks are the most suitable for external bases, plinths, and dwarf-walls for palisading, or wherever there is much traffic.

Enamelled bricks are now very extensively used instead of tiles; they can be obtained in various colours, and are suitable for facing dairies, &c., and areas where reflected or borrowed light is required. They are obtainable in double headers,

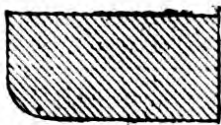

Fig. 8.

viz. two ends enamelled for 9-inch walls, and double stretchers for  $4\frac{1}{2}$ -inch walls, and bullnose bricks (Fig. 8) for jambs or reveals. The best kind are those

bearing the stamp, "Cliffe, Wortley, Leeds."

Firebricks should be used for all places exposed to the action of fire or intense heat. They are made of fireclay, and should be set with close joints in a mortar made of the same material, wetting the bricks before setting them. The mortar under the action of the fire will vitrify, and form one body with the bricks. In lining boiler furnaces, &c., bricklayers frequently use fireclay only with that portion of the work that will be subjected to the flame, but it may be set down as a rule that wherever it is necessary to use firebricks, it is also necessary to use *fireclay* to

bed them in. Nevertheless, when it is not readily obtainable, plaster of Paris and sand may be used as a very good substitute for small jobs, but on no account should cement be used, for being non-elastic it will fracture under the action of intense heat. Stourbridge bricks are much used on account of their cheapness; they are suitable for house fires, but not for large boiler furnaces. Dinas firebricks are the best, and are capable of resisting the temperature of  $4,000^{\circ}$  to  $5,000^{\circ}$  Fah.\*

#### CHARACTERISTICS OF GOOD BRICKS.

Soundness, freedom from flaws, cracks, or stones of any kind. They should contain no lumps of lime or limestone, however small; should be regular in shape and uniform in size, their length exceeding twice their breadth by the thickness of a mortar joint. They should not absorb at most more water than is equal to one-sixth of their dry weight. They should be hard, and burnt so thoroughly that there is incipient vitrification all through the brick. When struck together they should yield a clear metallic ring. (This last-mentioned characteristic belongs more to stocks and the harder kind of bricks.) Their texture should be homogeneous and compact. They should be regular in colour, with their arrises square, sharp, and well-defined. Pressed bricks, such as those from the midland counties, are almost non-absorbent.

\* Dr. Siemen's "Chemical Society," 7th May, 1868. '

## BOND OF BRICKWORK.

We will now enter into what might be termed the scientific part of bricklaying, and it will not be out of place to repeat what Smeaton wrote half a century ago with reference to this subject, and which is equally true to-day: "As the art of bricklaying is generally supposed to be so simple as to require little or no attention, it will be necessary to remove this false impression by a somewhat particular detail of the facts which relate to it. There are many persons, and even some workmen, who suppose that nothing more is required than that the bricks should be properly bedded and the work level and perpendicular. But the workman who would attain perfection in his business should acquaint himself with the different arrangements made use of in placing [bonding] the bricks, so that one part of the work shall strengthen another, and thus prevent one portion from a greater liability to give way than another."

So much for the statement of an eminent engineer, than whom none knew better the value of bonding, as evidenced in the old Eddystone Lighthouse, which was so thoroughly bonded, one stone into another, and each into the whole, that nothing but the wearing away of the rock upon which it stood led (or was likely to lead) to its demolition.

## OLD ENGLISH BOND.

Old English bond consists of alternate courses of headers and stretchers, while Flemish bond

consists of alternate headers and stretchers in each course. Old English is the only *true* bond, the other bonds (and there are several) being merely arrangements to please the eye. Gwilt, referring to bond, remarks, in his "Encyclopedia of Architecture," that "previous to the reign of William and Mary all the brick buildings in the island were constructed in what is called English bond; and subsequent to the reign in question, when in buildings as in many other cases Dutch fashions were introduced, we regret to say much to the injury of our houses' strength, the workmen have become so infatuated with what is called Flemish bond that it is difficult to drive them out of it. To the introduction of the latter has been attributed (in many cases with justice) the splitting of walls into two thicknesses; to prevent which expedients have been adopted which would be altogether unnecessary if a return to the general use of English bond could be established."

#### BOND OF FOOTINGS AND WALLS.

The Metropolitan Building Act requires that the footings of all walls shall not be less than twice the thickness of the superincumbent wall, or, as bricklayers call it, "the neat work."

Fig. 9 represents the footing for a brick-and-a-half wall. A two-

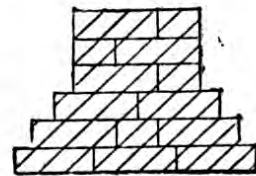

Fig. 9.

brick wall would require a four-brick footing, and so on, according to the size of the wall, setting back  $2\frac{1}{4}$  inches on each course of



footings until the wall be brought into its proper size. Where a "bat" occurs in the footings, as

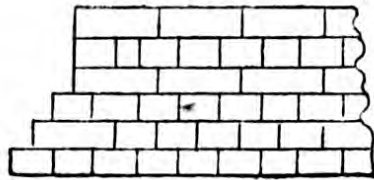

Fig. 10.

in the second course, it should always be kept in the centre. Fig. 10 shows in elevation the footings and three courses of a 14-inch wall. It will be

seen that the "closer" is not used until the setting out of the bond for the "neat work." Figs. 11 and 12 are the plans of two successive

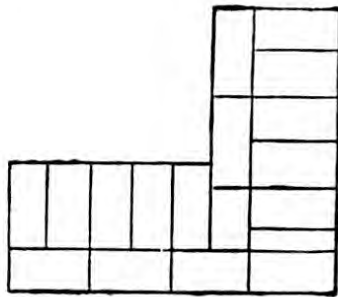

Fig. 11.

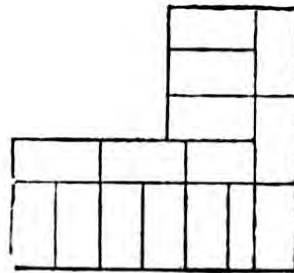

Fig. 12.

courses of a one-and-a-half brick wall, showing the sectional bond. It will be seen by this that there are no two joints in the wall immediately one above the other, but that in the direction of the length of the wall there is a lap or bond of  $2\frac{1}{4}$  inches of each brick over the two immediately below it in the next course, and a lap of  $4\frac{1}{2}$  inches in the width of the wall. This result is obtained by running the transverse joints right through the wall from one side to the other. A simple principle, but seldom carried out even by bricklayers.

The method in general practice is shown in

Figs. 13 and 14. It will be seen that the transverse or "cross" joints do not run through the

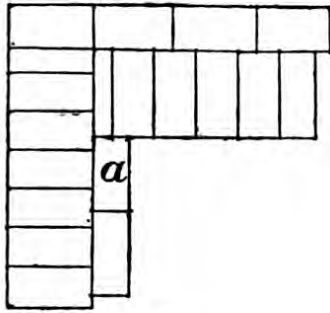

Fig. 13.

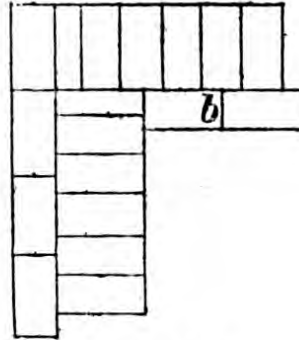

Fig. 14.

wall, but that the ends of the stretchers come in the middle of the headers, consequently the cross joints in the middle  $4\frac{1}{2}$  inches of the wall are one over the other from the bottom to the top of the wall. This is caused by showing full "stretchers," *a* and *b*, in the internal angle, instead of letting them pass  $2\frac{1}{4}$  inches into the return wall, as in Figs. 11 and 12. Many bricklayers insist upon showing a full "*stretcher*" in the angle in all cases; but he who insists upon this has yet to learn the bond of brickwork. The reader would be greatly helped to an understanding of

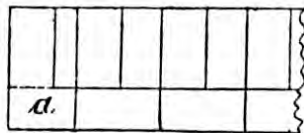

Fig. 15.

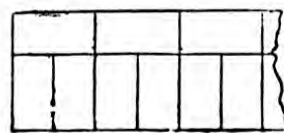

Fig. 16.

bond by having a few model bricks, and arranging them as shown in these Figs. Dominoes make very good model bricks. Figs. 15 and 16 represent a straight jamb in a 14-inch wall. Here

again, that the "cross" joints may run straight through the wall, it is necessary to introduce a three-quarter "stretcher" *a*, and to omit the "closer" in the next course above. Figs. 17 and 18 are the plans of two consecutive courses of a

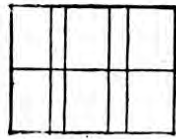

Fig. 17.

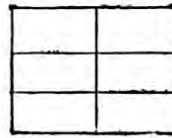

Fig. 18.

pier 14 inches on the face and 18 inches deep. The face bond is made up of two three-quarter "stretchers" on one course, and of three "headers" on the other. Figs. 19 and 20 are two courses of

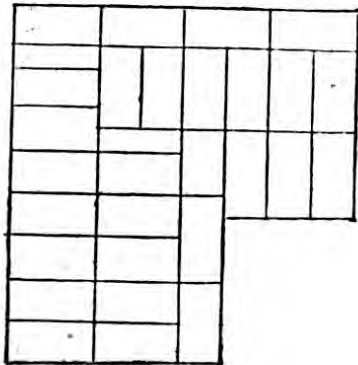

Fig. 19.

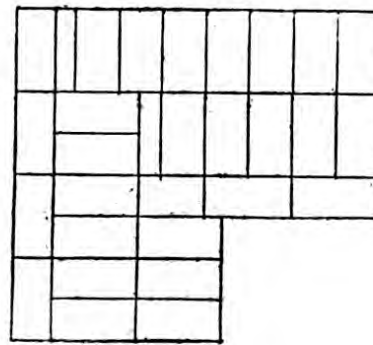

Fig. 20.

a wall two and a half bricks thick. In all walls of such a size as to take an odd half brick (two



Fig. 21.

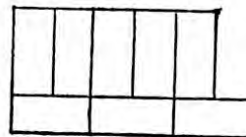

Fig. 22.

bricks and a half, three bricks and a half, &c.), the "stretcher" is always laid on the outside face in

one course and on the inside face in the next course. Figs. 21 and 22 show the "king closer," which in practice, owing to the trouble of cutting and the probability of breaking in the cutting, is seldom used. In this case two bricks are cut in their whole length from  $2\frac{1}{4}$  inches to  $4\frac{1}{2}$  inches, but it is more frequently cut out of one brick, as in Fig. 23, and an adjoining "bat" is cut to fit it.



Fig. 23.

A great many instances of bond in different sized walls and piers might be given, but as a thorough knowledge of "bonding" can be obtained only by practice, we will not multiply examples.

If the bricklayer adhere to the principle of keeping the "cross" joints immediately opposite each other, and laying the bricks in one course quarter bond with the bricks in the course below it, he will experience little difficulty with any sized wall or pier.

#### SETTING OUT THE BOND.

The chief thing in connection with brickwork is setting out the bond, for which a good bricklayer should be selected. This will be more readily recognised when we consider the strains to which a building is subject. The bond should be set out at least one course below the ground line, and the positions of doors, windows, panels, or large apertures taken off the drawings. This is best done in a stretching course, setting a "perpend" for every reveal or jamb, and working the

“broken bond” under each window, or other aperture, as the case may be, as in Fig 24, *a* and

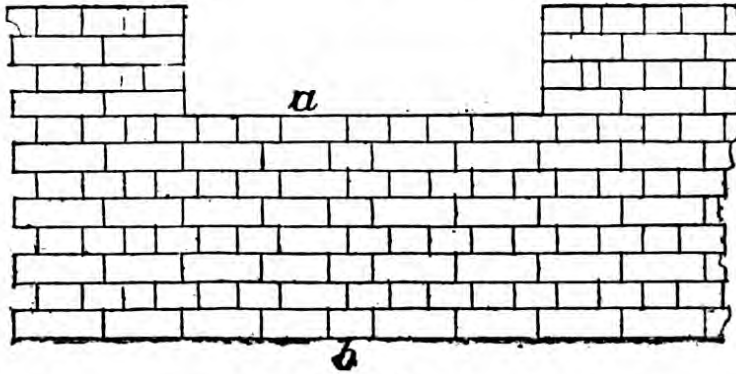

Fig. 24.

*b*. Reveals and jambs in point of bond should be treated as “quoins.” Where a base occurs the “bond” should be so arranged that a whole brick will work in the internal angle above the plinth.

In Fig. 25 we have a  $2\frac{1}{4}$ -inch plinth; a “per-

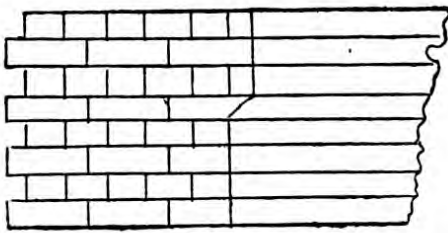

Fig. 25.

pend” or vertical joint in the stretching course is started  $6\frac{3}{4}$  inches from the angle at the base; this joint “plumbed” up will be 9 inches, or a brick, from the angle above the plinth, and work proper or con-

ventional “bond.” In many cases the base is treated by bricklayers as if it were a detached part of the building, and the consequence is that “closers” are to be seen in the internal angles of many good buildings where whole bricks should be found. Such things, though small in themselves, go a long way to make up or to detract

from the general effect and appearance of a building.

“Broken Bond” is the result of badly proportioned piers; thus, in a pier 3 feet  $2\frac{1}{2}$  inches long, the bricklayer would have to work four bricks and a quarter, but to do away with the quarter or “closer,” a header and a three-quarter “stretcher” are substituted for a “stretcher” and the “closer,” the three-quarter and “header” making up the “broken bond,” and are kept as near as possible in the middle of the pier.

The work once above the ground, the building should be levelled all round, and a piece of hoop-iron fixed in a joint at each corner or angle to gauge or measure from, taking care that they are all in the same level course. A “gauge-rod,” reaching from floor to floor, with all the courses and stone strings (if there be any) and heights of window sills and heads marked on it, should be given to the bricklayer to work to, by which means he can at any time see how his work is rising, which in London should not exceed nor be less than four courses to a foot; and the careless or inferior workman will then have no excuse for not keeping his work level and to the gauge. Not working to a gauge-rod is the chief cause of thick and thin joints, though any competent workman with a 2-foot rule should be able to keep his work right. The bricks in building should be wetted, but not to saturation, and the mortar of such a consistency that the “cross” joints between the bricks can be drawn up as the

bricks are laid ; any open or partially filled joints can then be filled by “flushing,” which is to be preferred to “grouting,” and should be done on every course.

### HEADING BOND

is the name given to that arrangement in which the bricks are laid all “headers.” This bond is used in circular and curved walls of a short radius, and

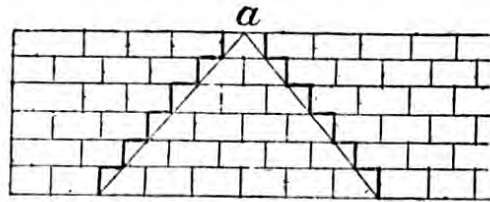

Fig. 26.

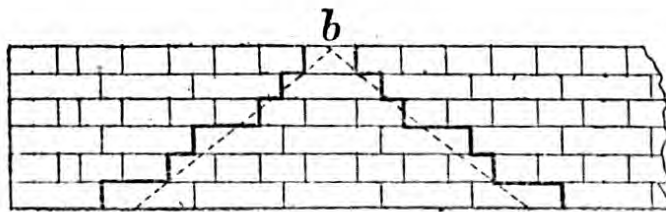

Fig. 27.

in round chimney stacks, so as to keep the wall within the “sweep,” or arc, for if “stretchers” be used, every 9 inches of the wall will be a straight line, and when built will consist of projections and hollows, and will be in that state described by bricklayers as “*hatching and grinning.*” Heading bond should never be used on straight walls or where it can be avoided, as very little longitudinal strength is obtained, as will be seen by reference to Figs. 26 and 27, showing the angles of strain in two walls, one in heading bond and

the other in English. The thick lines show the direction a fracture would take in the event of a settlement. They also show the space over which any given weight resting on either *a* or *b* would be distributed; and this idea leads us to the consideration of the use of stone templates and strings in connection with brickwork.

#### TEMPLATES AND STRINGS.

Templates under girders, principals, beams, &c., should always be of York, never of Portland or any similar stone, and should be at least 14 inches long—18 inches would be better, but the length must be regulated by the weight which it has to carry. There is little doubt that “string courses” in the shape of a flush band were first introduced to impart strength to walls whose component parts were of diminutive dimensions (the Roman tile for instance, used in Roman walling), and that their ornamental feature was a secondary idea and an outgrowth of the former. String courses and bands are still used very extensively for this purpose, and are placed generally at the floor line, the window sill level, or the window head or springing line, and in some buildings in each and all of these positions.

#### BATS.

A consideration of the previous remarks will have illustrated the evil attending the use of “bats.” The greatest evil in connection with them is that workmen when walling, instead of fairly



distributing them amongst the whole bricks, generally allow them to accumulate on the scaffold, and when they have a quantity put them in the wall all of a heap, much to its injury. Good work may be done with a fair proportion of "bats" if they be used with discretion; and it is only fair to the builder that he be allowed to use the bats made on the job.

### FLEMISH BOND.

Having already pronounced upon the merits of this bond and given the opinion of an eminent authority (Gwilt), little remains to be said on this subject beyond explaining a few examples in different sized walls and piers.

Figs. 28 and 29 show a 14-inch wall with a

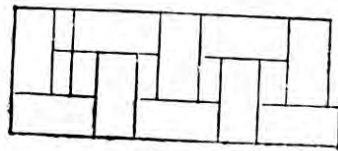

Fig. 28.

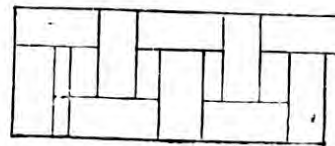

Fig. 29.

straight jamb, both sides Flemish bond, showing the way such a wall is generally bonded in practice. The rule laid down to keep the "cross" joints straight through the wall is departed from in this example, consequently the joints in the middle of the wall are one over the other in the entire height of the wall. The proper method is shown in Figs. 30 and 31, in which the "closer" is dispensed with, and two "headers," *a*, in one course and a three-quarter "stretcher," *b*, in the other are used. A heading and stretching course

are obtained by laying whole headers on one face and "snapped headers" on the other. A still

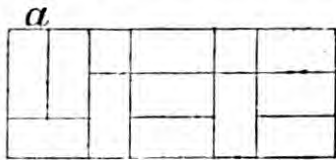

Fig. 30.

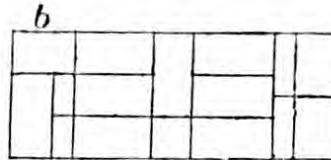

Fig. 31.

better bond would be obtained by laying the headers on each face, alternately "header" and "snap;" but to prevent all "snaps" coming over each other and all whole headers over each other they (the "snap headers" and the whole "headers") should be alternated in the height as well as on the level.

Figs. 32 and 33, the same wall, with the face

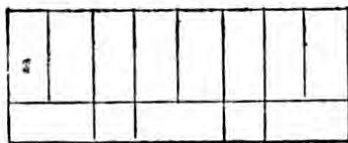

Fig. 32.

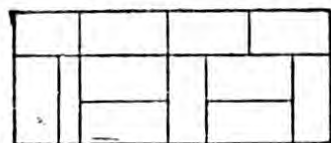

Fig. 33.

in Flemish and the back in English bond. A good strong wall can be obtained in this way, and where the inside has to be plastered it should always be so built.

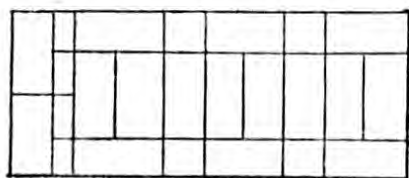

Fig. 34.

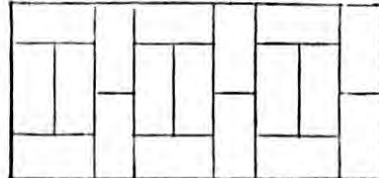

Fig. 35.

Figs. 34 and 35, a two-brick wall, Flemish bond both sides. By snapping the headers in

one course, 34, and putting them whole in the other, 35, a heading and a stretching course are obtained, which gives a much better bond through the wall than if all whole headers were used. Fig. 36, a quoin in isometric projection, showing the

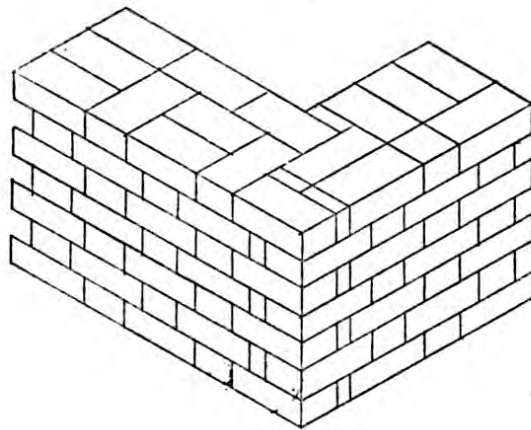

Fig. 36. ]

internal and external angle, and a perfect bond as far as obtainable in Flemish bonding with the inside face built in Old English bond. Fig. 37 gives

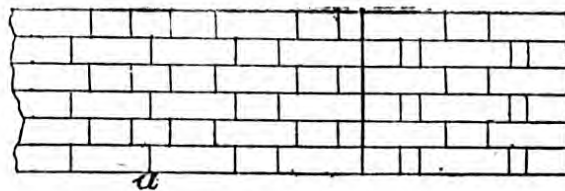

Fig. 37.

the bond of a two-and-a-half brick pier projecting from a wall. At *a* is shown a broken bond—two “stretchers” in one course and three “headers” in the next course above them, which frequently occurs, and is the only legitimate “broken” bond in Flemish. Where a three-quarter “stretcher” occurs as “broken” bond, it can be obviated or

done away with by "reversing" the bond on one end of the pier or wall. Thus for a "stretcher" substitute a "header" and "closer."

#### VARIOUS BONDS.

Chimney bond is a term applied only to  $4\frac{1}{2}$ -inch external walls to chimney stacks. In this arrangement the disposition of the bricks is such as to obtain the greatest possible strength by bonding in the "withes" on every second course, and avoiding the use of bats as far as practicable.

Stacks of  $4\frac{1}{2}$ -inch walls should never be built in Old English bond, for the reason that bricklayers, when cutting the half bricks to form "snap headers," will sometimes cut them  $3\frac{1}{2}$  inches in depth instead of  $4\frac{1}{2}$  inches, depending upon the pargetting or mortar to make up the thickness of the wall, which when the flue comes into use will shrink and crack, and falling away from the brickwork leave a stack, in many cases, built partly of closers. English bond is also objectionable on account of the numerous bats. Another practice in  $4\frac{1}{2}$ -inch stack building, and which cannot be too severely condemned, is that of "buttering" the cross joints with the point of the trowel; or, in plainer words, putting a mortar joint between the ends of the bricks, extending in about 1 inch from the face, the remaining  $3\frac{1}{2}$  inches being left open, excepting what little may be filled up in the process of pargetting.

We believe this practice, together with that of plugging into  $4\frac{1}{2}$ -inch chimney walls for fixing

skirtings, to be a fruitful source of many fires, with accounts of which we are occasionally startled. The mortar or cement joints should be put *right through* the width of the bricks, and drawn up solid and tight. Stacks with  $4\frac{1}{2}$ -inch walls may often be built with advantage in Flemish bond; but the main thing to be attained is strength, which is to be obtained only by bonding in the "withes" or divisions between the flues. Another reason the author would advance in objection to  $4\frac{1}{2}$ -inch walls for chimney stacks is that plumbers, in "flashing" round the base, cut out the joints for the purpose of turning in the lead; and when wedging the same, thoughtless of the power exerted by the wedge, often break the bond of adhesion between the mortar and the course above the "flashing," leaving the stack in this condition to withstand a wind pressure of from 40 to 50 lbs. on the square foot during a hurricane, often resulting in a coroner's inquest. Zinc "soakers" may be used with much advantage in connection with stacks built with  $4\frac{1}{2}$  inch walls, and the angles formed by the junction of the stack and the slating filled in with a small cement fillet, triangular in section, making a perfectly sound and water-tight job, doing away with the necessity of flashings, and preventing the evils that sometimes attend them.

English garden-wall bond consists of three courses of "stretchers" to one course of "headers." This bond may be said to have grown into disuse, excepting in the north of England, where five

courses of "stretchers" to one course of "headers" are frequently used in general building. Flemish garden-wall bond consists of three "stretchers" to one "header" in every course, as in Fig. 38.

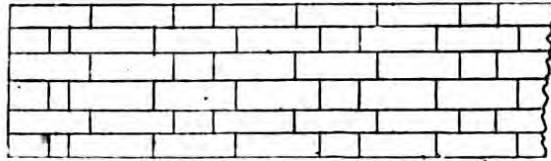

Fig. 38.

Garden-wall bond is used only, as its name implies, for 9-inch garden walls that have to be kept fair or smooth on both sides. The bricks vary most in their lengths; the more "headers" that are put through the wall will, therefore, add to the difficulty of keeping it straight.

#### HERRING-BONE BOND.

Figs. 39 and 40 represent a panel filled in with bricks laid "herring-bone." The former is gene-

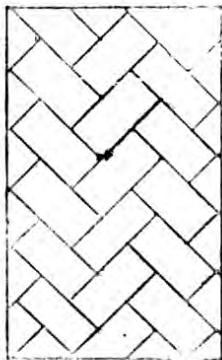

Fig. 39.

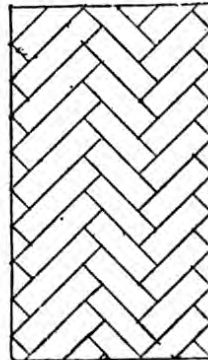

Fig. 40.

rally the method used in paving, where the bricks are laid on their beds,  $4\frac{1}{2}$  by 9 inches, in sand, and "grouted" up with cement or mortar. The

latter is used for filling in panels under windows and for tympana of arches, and are laid four courses to the foot. When a large area of paving has to be done in this way, the simplest way will be to work from a centre line, and lay the middle course first and at an angle of 45 degrees, the other courses will then follow, and the points may be kept right by means of a line drawn parallel to the centre line.

In a panel, the first brick starting from the corner should be set to a small set square, forming a right angle and two angles of 45 degrees, and measuring from the base to the apex 3 inches, or whatever the bricks will work.

#### DUTCH BOND.

Fig. 41 is an arrangement called Dutch bond. It is a modification of English bond, the "closer"

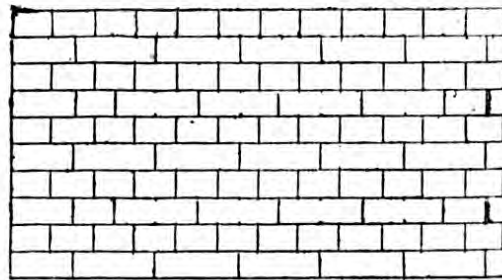

Fig. 41.

being omitted and a three-quarter "stretcher" used on the "quoin." In every third stretching course a "Flemish header" is introduced next to the "quoin" brick, by which means the "stretchers" in that course are pushed forward,

and overlap the "stretchers" below  $4\frac{1}{2}$  inches, instead of being "plumb" over them as in other bonds. The advantage of this bond is that additional strength is imparted to the wall in the direction of its length, and that without diminishing its transverse strength. A writer in the *Builder*, from which Fig. 41 is taken, speaking of this subject says : "As regards construction in common English and Flemish bonds, no greater tie in the direction of the wall is obtained than  $2\frac{1}{4}$  inches which one brick overlaps another. If, therefore, a fracture takes place, the crack runs down the wall, following the joint with only that small deviation from a perpendicular line ; but by the Dutch method a crack would have to follow  $4\frac{1}{2}$  inches to the right or left in the courses containing the 'Flemish header,' or else break through the bricks. Clearly, therefore, we have some additional strength, the lap between the courses of 'stretchers' being as much as  $4\frac{1}{2}$  inches."

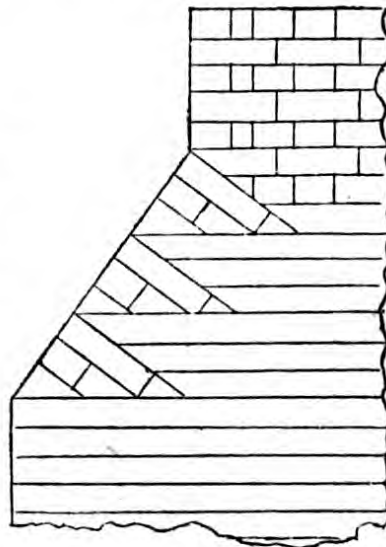

Fig. 42.

The adjoining Fig. 42 shows the way in which buttresses and chimney stacks are reduced. They are generally "tumbled in" at an angle of about 60 degrees. The beds of the bricks should always be at right angles to the "tumbling in." The



bond on the "battering" jamb will be the same as on the upright jamb below.

"KEEPING THE PERPENDS."

Architects usually specify that the "perpends" shall be kept, or, in other words, the vertical joints are to fall in plumb lines from top to bottom. Owing to the difference in the sizes of bricks, this cannot be done with bricks as they come to hand; they must be sorted to a length, or cut where necessary, by the bricklayer as he proceeds with his work. This would add to the cost of the work, and, as cost has to be considered in most buildings, it is seldom done. But if the bricklayer carry up a plumb line in the middle of large piers, and work his bricks between that and the plumb reveals or jambs, he will be able to keep his "perpends" tolerably regular. The "closers" should be cut to a  $2\frac{1}{4}$ -inch gauge.

TOOTHINGS.

Toothings should not be allowed in a building where they can possibly be avoided; they are a source of weakness, and very often a disfigurement to a building. When building into toothings, the bricklayer seldom takes the time or trouble to make solid work; and where they have been can very often be traced in buildings that have been up but a short time by the pointing having fallen out right down the line of toothings. This is caused in frosty weather, by the expansion of moisture which has got into the hollow parts of

the toothings, forcing the pointing from the brickwork, to be washed off by the first heavy rainfall. Where toothings are unavoidable, they should not be carried up in a straight line from bottom to top, as they usually are, but should be stepped back every few courses, so that the new work may be bedded solidly here and there. When building new work into old, a chase is preferable to a tothing, as the new work is left free to settle. But in a front where new work has to be built into an old tothing there should be no mortar used in the tothing; the new work should be kept a trifle high above the old, and the joints of the tothing filled in after the building is up. Among the characteristics of good brickwork are solidity, perpendicularity, smoothness; the vertical joints carry a plumb line from top to bottom, and the "cross" joints of the "stretchers" fall immediately in the centre of the "headers," and the bed joints are neither too thick nor too thin.

#### GROUTING.

"Grouting" is the practice of using mortar or cement in a semi-liquid state to fill up the open joints in the work, the result of careless or bad workmanship. In some works every course is "grouted" in; in others every four courses.

"Grouting" is not the best way to obtain solid walls, for the mortar being in a semi-fluid state, the excess water is absorbed into the bricks of which the work is composed, and, as a conse-

quence, the "grouting" shrinks or subsides, leaving the joints or interstices only partially filled. A better process is that of "*larrying-up*," which is, after having laid a course of bricks on each side or face of the wall, to put a proper amount of mortar in the wall, and by the addition of water, and the use of trowels, shovels, or a larry, to reduce it to such a consistency as to be able to swim in the bricks solidly. Even in this practice there is a subsidence or shrinkage of the mortar, with the same effect, though in a less degree, as described in "grouting." But the best and proper plan is undoubtedly that of putting up the joints solidly through each brick as it is laid, and having the mortar of such a consistency as to be able to draw the joints up solidly when filling in the middle of the wall.

#### FLUES.

Of the abominations of a bad building, bad flues are second only to bad drains. The causes of smoky flues are as follows. The sectional area of the flue is either too large or too small. Its sectional area is cramped, the "cramp" generally occurring in sharp bends, close to a floor, where the bricklayer has to make room for another fireplace. The flue is too short, or is not carried up high enough to be above some adjoining building or contiguous wall. There is too much air-space below the throat of the flue, or, in bricklayers' language, the wing gatherings are not brought over fast enough. In considering the scientific

principle of flues, we should remember that the properties of air in their action are very similar to those of water. A stream with a straight smooth course flows swiftly and regularly, while one with a rugged winding course is full of eddies and whirls, and flows with a retarded velocity. So it is with flues. An unused flue contains a column of cold air in equilibrium with the surrounding air. This column of cold air must be rarefied or heated before a good draught can be obtained, when the denser air rushes in, pushing the lighter up. This will account for the fact that a flue never draws so well when the fire is first started as it does some little time after.

Where the flue is unnecessarily large, a larger volume of air has to be rarefied, and it also admits of a possible down draught, or in other words an ascending and a descending column, in consequence of the heated air not filling the flue. Where the flue is "cramped" somewhere in its length, the cause of smoking is that the smoke is checked in its ascent just where the "cramp" occurs, the smoke escaping with a retarded instead of an increasing velocity. Sharp bends have the same effect, though in a less degree, as "cramps." Yet it is a common thing to hear bricklayers advocating sharp bends in flues to increase their draught.

Every flue should be formed with sufficient bend to prevent the daylight and rain falling upon the fire.

Where a flue terminates below an adjoining wall, it will often smoke in consequence of a

down draught, caused by the wind striking against the wall and in its rebound passing down the flue, or at least obstructing for a time the passage of the smoke from the flue, which in effect is similar to a down draught. Where the throat of the flue is formed high up above the chimney bar there is a large volume of cold air collected which has to be heated or rarefied to get a proper draught ; until this takes place the smoke is obstructed in its ascent, and driven back into the room.

To cure these evils, innumerable contrivances have been invented, of various forms and different degrees of ugliness, and it is almost rare to see a house in the metropolis that is not surmounted with one or more of these articles, each advertised as a panacea for smoky flues. These so-called remedies are (with the exception of the "blower") always applied to the top of the flue, when in fact the remedy is generally required at the bottom or somewhere in the length of the flue. We would give the following advice for flue building. Form the throat of the flue as low down as possible, and let the sectional area be the same throughout its entire length, avoiding all bends beyond what is necessary to hide light. Where bends cannot be avoided let them be as easy as possible, and carry the flue well up above contiguous structures, and let it be pargetted smoothly inside. In building flues "coring holes," 12 × 14 inches, should be left out on every floor, or at least where every bend occurs,

and a piece of board put in to catch the mortar and brick rubbish that fall while in erection. By this method the flues may be easily "cored" or cleared without the aid of a chimney sweep. Flues for dwelling-houses are generally for registers,  $9 \times 14$  inches, and for kitchens  $14 \times 14$  inches.

Fig. 43 is the plan of a fireplace and flue for a register stove, which we insert by permission of the originator, H. Saxon Snell, Esq., F.R.I.B.A.

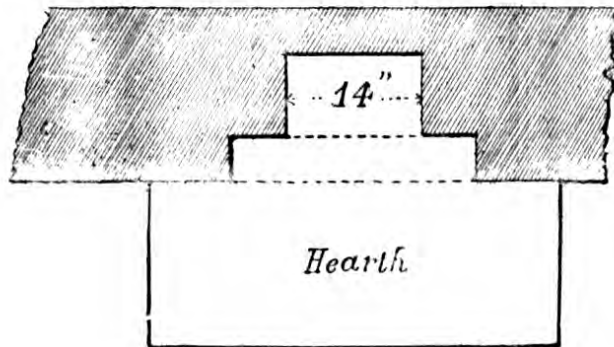

Fig. 43.

The peculiarity and advantage of this fireplace is that the sectional area or throat of the flue commences immediately on the chimney bar, doing away with the necessity of wing gatherings and the possibility of cold air collecting round the base of the flue. This for its economy of construction and efficiency of action recommends itself for general use.

All chimney stacks from the part where they pass through a roof, or from the point where they separate from a wall with which they have been in junction, to their tops, should be built in cement and sand instead of with lime mortar.

Where several flues are grouped together in one stack, instead of dividing them with the usual  $4\frac{1}{2}$ -inch brick "withes," Boyd's flue-plates (iron plates  $\frac{1}{8}$  inch thick, and about 12 inches square, fitting into each other with a tongued and grooved joint, and built into the sides of the stack) are often introduced to economise space.

## SECTION II.

## ARCHES IN GENERAL.

## ARCHES.

ARCHES are of various kinds, but those which the bricklayer has to deal with are either circular, segmental, scheme, elliptic, or Gothic. To the young operative, and in many cases to the aged workman, they are veiled in mystery, though a little application and determination to understand them would soon make them clear to the operative who would be master of his trade. Time was when the arch-cutter would box himself up and carefully tack strips over the chinks between the boards that prying eyes might not penetrate into his cutting-shed and discover the craft by which he held himself superior to his fellow-workmen. This jealousy and exclusiveness is still alive, though it is being slowly trampled under by means of the flood of light that is spread abroad, and is still spreading, from technical classes and technical publications. If the young workman will but set to work in earnest, there is every facility to acquire technical knowledge, and to make himself, as a workman, superior to those who have gone before, and who,

“By geometric scale,  
Did gauge the size of pots of ale.”

Let him but catch that spirit breathed forth in



Longfellow's lines to Strasburg Cathedral, and success will surely be his :—

“ A great master of his craft,  
Edwin von Steinbach ; but not he alone,  
For many generations labour'd with him.  
Children that came to see these saints in stone,  
As day by day out of the blocks they rose,  
Grew old and died, and still the work went on,  
And on, and on, and is not yet completed.

The architect

Built his great heart into these sculptured stones,  
And with him toil'd his children, and their lives  
Were builded with his own into these walls,  
As offerings to God.”

The word *arch* implies an arrangement of bricks or other material in which all its parts—we might with equal propriety say particles—are in equilibrium ; or, in other words, that the pressure or thrust to which it is subjected is transmitted from one course to the other, and distributed throughout the whole of the arch, each course or voussoir taking its share. Every bricklayer who has turned an arch will have noticed that this condition is not obtained by simply turning the arch on its centre and keying it in, the tendency being for the arch, by reason of its own weight, to spread out at the haunches, or if this be prevented to buckle up at the haunches, to prevent which and bring about equilibrium, calculations have to be made so as to apportion the weight at the haunches to resist or counteract the thrust from the crown. Such mathematicians as Dr. Hooke, Huygens, Leibnitz, and many others, devoted much time and attention to the solution of the principle of the arch under the

name of the *catenary curve* (Latin *catena*, a chain); and the conclusion *they* arrived at was, that the true shape of an arch is that into which a chain would arrange itself if freely suspended from two hooks whose distance apart is equal to the span of the intended arch. We have mentioned these things because, considering the way in which arches are often *thrown* together, it is well that the artisan should know there is a principle involved in their construction.

#### RELIEVING ARCHES.

Relieving arches should be turned over all lintols where practicable, and should spring clear of their ends. They should not be built, as they generally are, solid on the brick "core," whereby the weight of the wall above is transmitted from the arch to the "core," from the "core" to the lintol, and from the lintol to the frame, very often to the great injury of the latter; but should be built at least  $\frac{3}{4}$  inch clear of the "core." This can be done by putting a layer of sand  $\frac{3}{4}$  inch thick on the core, and raking it out with a trowel or piece of hoop iron when the arch is turned, that it may take its own bearing. They should be turned in compo.

The above remarks apply to where the window and door frames are built into the brickwork during erection; and more particularly to arches intended to relieve free-stone rectangular door and window heads. It is not an uncommon thing to see such heads fractured right through their

depth in about the middle of the openings which they span, and kept from falling only by the weight of brickwork upon their ends ; though the architect has been careful to provide against superincumbent weight by the use of relieving arches, but which, through inexperience or want of judgment, have been built upon a solid "core."

#### PLAIN ARCHES.

All arches put in with bricks as they come from the brickfield come under the term plain arches, and are built in concentric rings of  $4\frac{1}{2}$  inches laid as "headers" on edge, instead of bonding by "stretchers," to avoid the large joints that would unavoidably occur at the extrados, thereby decreasing the strength of the arch unless it were built with cement, or a strong hydraulic mortar, as lias.

#### THE SKEW OR OBLIQUE ARCH.

This arch is used in the construction of bridges over roads or waterways where the bridge is not at right angles to the road passing under it.

Two very remarkable arches of this kind may be seen on the Metropolitan District Railway at Brondesbury, and which the writer believes to be the only bridges so constructed. Of these we will speak hereafter.

To set out and understand drawings of the skew arch, a knowledge of solid or descriptive geometry is indispensable ; but as the setting out is generally performed by the engineer or in-

spector of works, we will confine our remarks to that portion of the work which properly belongs to the operative bricklayer. A B C D, Fig. 44,

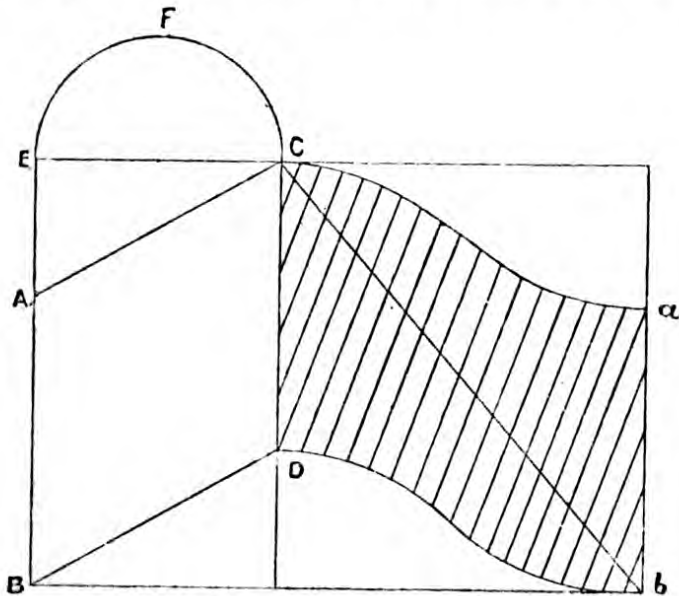

Fig. 44.

represents the plan of a skew arch of which E F C would be a section cut square with the abutments. E C A is called the angle of skew, for it shows how much out of square the face of the arch is with the road. *a c* is the face of the arch, and as the "bed" joints (called by engineers "coursing" joints) start square from the face, they must run in a diagonal direction across the centre, as seen in *c D a b*, which is a development of the soffit of the arch. To make this clear, we will suppose the courses to be pencilled on the centre, and a sheet of white paper folded round the centre and rubbed until the pencil marks be transferred to the paper. If the paper—fastened at *c D*, the abutment line—be now un-

folded from the centre and spread out on a level surface as in Fig. 44, we shall have a development of the soffit of the arch.  $ca$  is the length of the line on the centre from  $c$  to  $A$ .  $db$  is the length of the line on the centre from  $D$  to  $B$ , and is

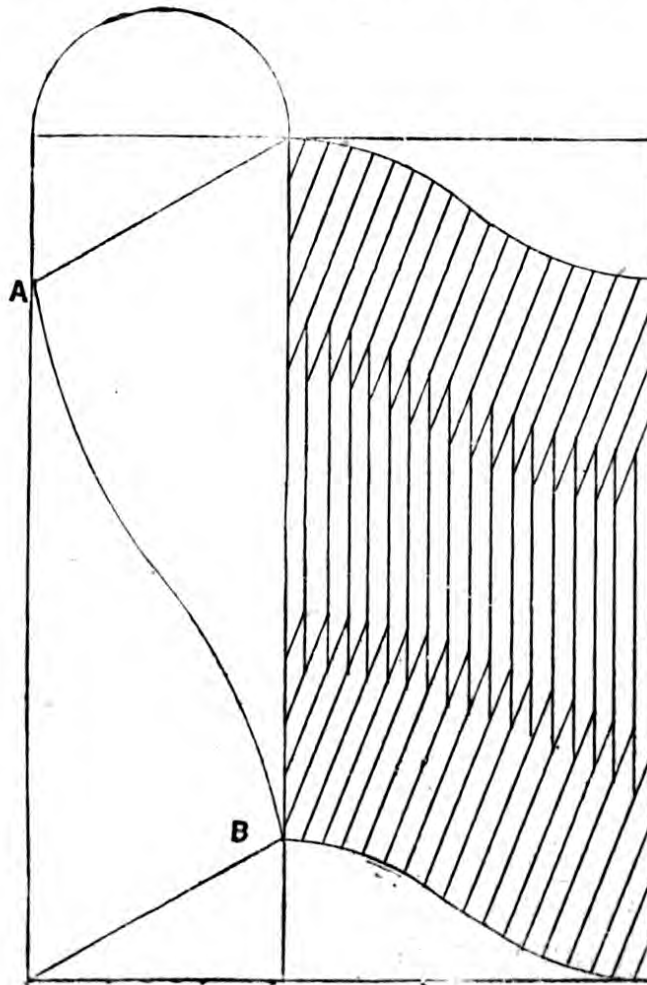

Fig. 45.

parallel with  $ca$ .  $cb$  is the length of a line on the centre from  $c$  to  $B$ .

In long skew arches the bricks, instead of being laid on the skew all through the arch, are arranged as in Fig. 45, where the skew courses

are intersected by courses laid parallel with the abutments. The skew courses are marked on the centre by means of a "coursing mould," which should be supplied by the engineer or inspector in charge of the work. A B is the plan of a line on the centre from A to B. All the courses on the centre will be so many spirals or screws parallel to each other. Each brick on the face of the arch will require a different bevel, but by far the easiest and the best way to get these will be to let the bricks stand well out in front of the face line, and cut them off to the line of work when the centre is struck. But when the bricks used are too hard to be cut, such as Staffordshire blue bricks, they must either be moulded to the required levels, or after the first ring allowed to project one in front of the other, and thus form what is known as a "dogstooth."

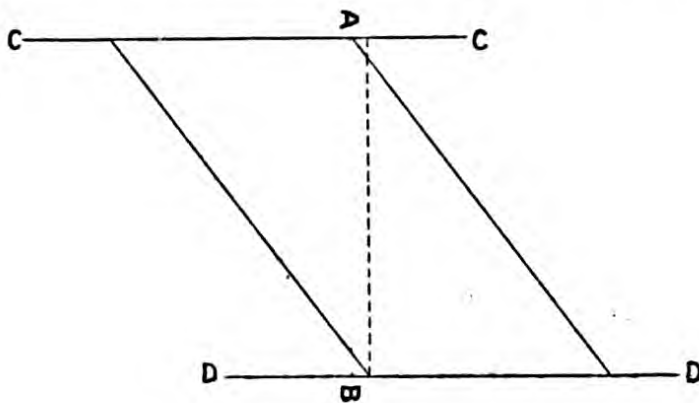

Fig. 46.

#### SKREW ARCH AT BRONDESBURY.

The remarkableness of this arch or skew is not alone in its construction, but in the angle that it

makes with the roadway that it spans, the angle being so acute as to cause the abutment line or skew-back of one side to fall *without* the abutment line of the other side. This is shown by the line  $AB$  at right angles to  $CC$ ,  $DD$ , Fig. 46.

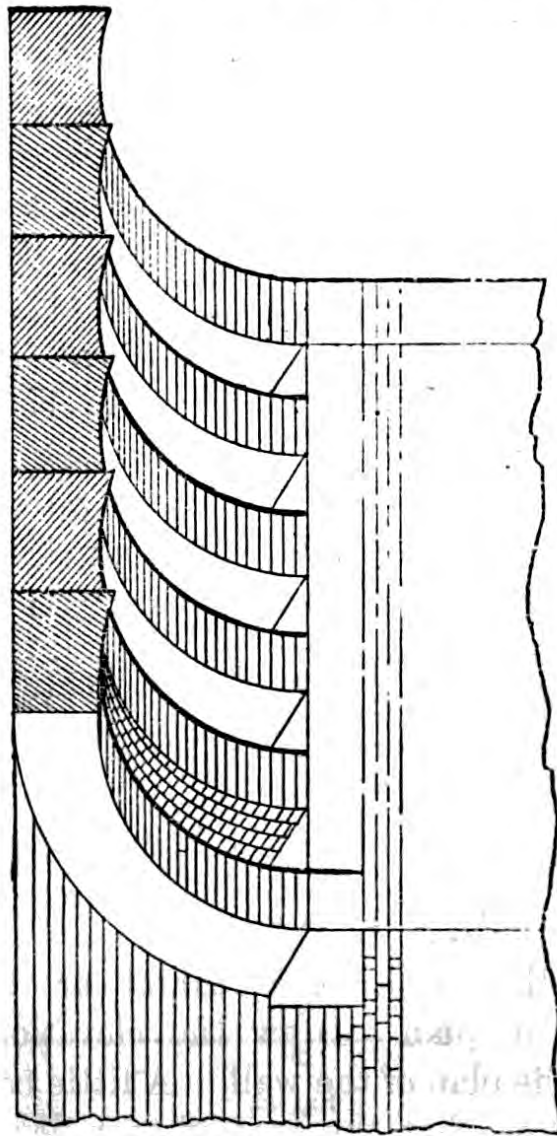

Fig. 47.

Let us imagine that across a given road we have to construct a bridge whose angle of skew

shall be equal to that on the accompanying

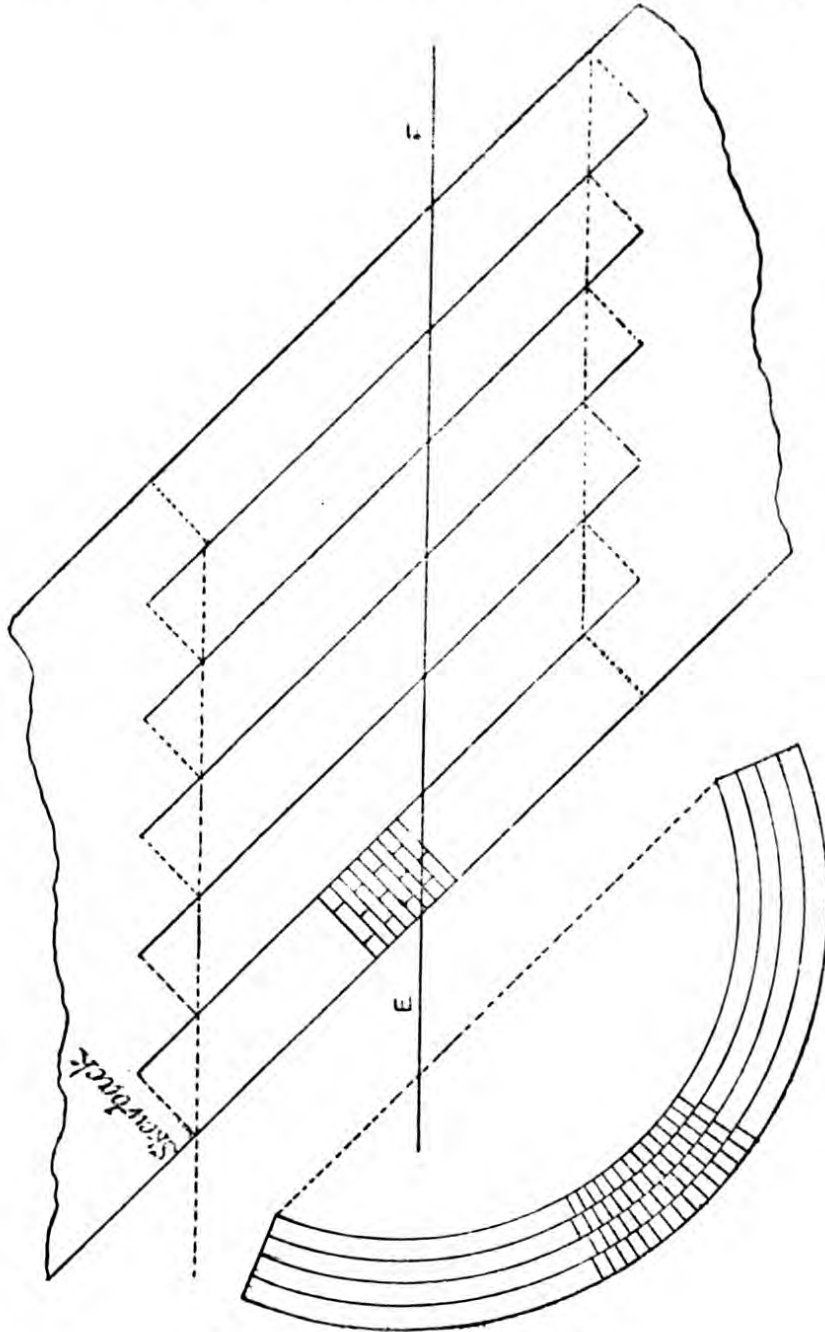

Fig. 48.

Fig. 49.

Fig. 46. It is clear that we cannot construct it on the principle of the ordinary skew arch, viz.



to take the courses (starting square with the face of the arch) as so many spirals across the centre, finding their abutment in the line *c c*, and as we have explained at page 47. An arch so constructed could not stand, for the lines of force, or thrust, acting at right angles to the abutments, would find no resistance, and consequently collapse. But the engineer who designed the bridge in question, seeing this, fell back on the principle that should regulate the construction of all arches where strength is required, that *the bed joints shall be in the line of radii, and on the soffit parallel with the abutment*, and thus in the simplest, yet most effective manner, solved the otherwise difficult problem. Fig. 47 shows the sectional elevation on the line *E F* in plan, Fig. 48 the plan, and Fig. 49 the face arch in elevation of a bridge somewhat similar to that at Brondesbury, constructed in the same way, and involving the same principles.

The plan of the abutments and skew-backs are shown by dotted line (Fig. 48).

The following are approximate dimensions of this bridge, which we have taken by step measurement: distance between abutments, 45 feet; depth of bridge, measured along the abutment, 26 feet; rise of arch from cord line to crown of soffit, 20 feet; projection of one abutment beyond the other (*D* beyond *A*, for instance, Fig. 46), 36 feet. The arch is made up of twelve  $4\frac{1}{2}$ -inch rings of brickwork.

## WATER CONDUIT.

Fig. 50, a section of a water conduit in Massachusetts, U.S.A., upon which the author was engaged as inspector of works, is worthy of notice, as showing the construction resorted to where a bad bottom occurs. In this case a large

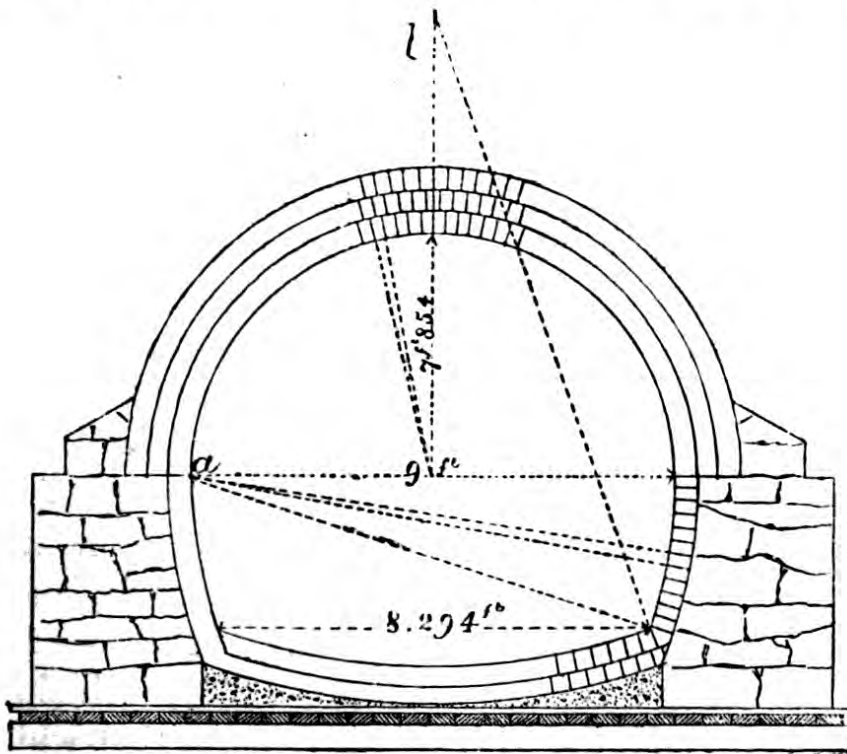

Fig. 50.

portion of the work (which was eighteen miles in extent) ran through very swampy ground, a natural watercourse that drained a large tract of the adjacent country, and at times so great was the pressure of the water as to cause it to rise in a natural fountain 6 or 7 feet above the excavations. When this occurred, stones of sizes similar to those of which the retaining walls were

built were shot into the hole until the water subsided. It was also necessary to keep pumps working night and day.

The bottom consisted of  $6 \times 6$  inch transoms, 18 inches apart, to which were spiked 2-inch planks, and these in turn were covered with 1-inch boards, with joints properly broken, as in flooring. The invert, when the side walls were built, was formed with concrete ready to receive the brickwork. The whole of the work, including concrete, was built in Rosendale cement, manufactured in Rosendale, New York, from a stone found in that locality, which when manufactured is in colour very similar to Roman cement, but less quick in setting, and attains a greater ultimate strength. It will be noticed that the sides of the invert are struck from the springing line *a*, and the bottom from *b*, and that to get the requisite skew-back for the top and bottom beds, a *purpose made* brick is introduced, whose beds are in the line of radii from *a* and *b*.

Sewers are constructed on the same principle as water conduits, with this difference, that while strength and sound work suffice for the latter, to these must be added smoothness for sewers, avoiding all "shoulders," "lips," protuberances, or other irregularities likely to increase friction, or in any way retard the velocity of the sewage. For this reason they are very often built egg-shaped, especially where the flow is intermittent.

## GROINED VAULTING.

Brick groin-vaulting (a very neat sample of which may be seen at the entrance to Winchester Flats, Winchester Terrace, Chelsea Embankment) was at one time very much in practice, but moulded stone ribs finishing at the apex with a carved boss now generally take the places of the brick groins. Samples of this kind of work may be seen at St. Augustine's, Kilburn; St. John's, Auckland Road, Upper Norwood, and the red brick church adjoining the Croydon railway station, all designed in that style known as the thirteenth century, or Early English, by John L. Pearson, R.A. Some good Gothic vaulting in red brickwork may also be seen at the New Law Courts, London. In executing the groin the bricks must be cut so as to form a return on the intersecting arch or vault; but a proper bond, as in square angles, cannot always be obtained, for, instead of the bricks returning from right to left and from left to right every other course, it will be found necessary to sometimes return several courses in succession, all from one side, before getting what bricklayers would call "a tie." This is caused by the groin not getting away fast enough from an imaginary line drawn across the arch from E to G Fig. 51. It is also impossible to keep the perpends regular near the groin, but they should be kept as regular as practicable with a good bond on the groin.

Before the bricklayer can cut his bricks, the

centres must be placed in position, and the bricks can then be cut to fit the intersection, which they should very accurately, and when the centres are "struck" present clean and well-defined arrises. Fig. 51 is the plan of two semi-vaults, intersecting in the groins E F and G H. The

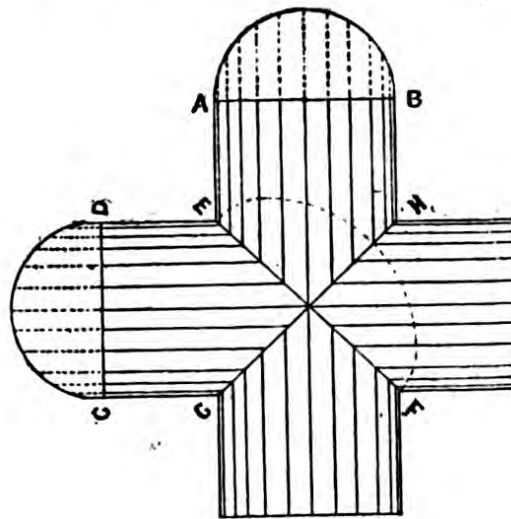

Fig. 51.

curve formed by the groin is an ellipse shown on E F by dotted curve. Sections of the vaults are shown on A B and C D. Sometimes instead of being as here shown, the intersecting arches are Gothics, or one Gothic and the other semi-cylindrical; but if what we have written be understood no difficulty will present itself. In all such cases the bricklayer must space his centre out into courses, and turn the arches as any other arch, with the exception of the groin, which must be treated as described.

In Gothic vaulting, as described above, in which the spaces between the stone springers are

filled in with brickwork, the setting out of the courses is done by marking upward from the intersection, or springing of the ribs, an equal distance along the cross rib and the diagonal or converging rib, and connecting these two points with a line. Upon another line at right angles with this, the courses may be pricked in from springing to apex, and their beds shown by lines parallel with the first line.

## SECTION III.

## GAUGED-WORK AND ARCH-CUTTING.

## GAUGED WORK.

“Cutting” is divided into “axed work” and “gauged work.” In the former the bricks are finished with the Scotch, with just a rub or two round the rubbing stone to take off the irregularities of the beds, allowing  $\frac{3}{16}$  of an inch joint for tuck-pointing. This work is intended to represent “gauged work,” and is supposed to be a trifle cheaper. “Gauged work” is a very superior kind of brickwork, executed in soft bricks set with a white putty joint, which should not exceed the thickness of a new sixpence. The bricks used are Fareham rubbers and T. L. B. rubbers for red work; and malm-cutters and sometimes white Suffolks for malm or stock work. Of red bricks Fareham Rubbers are the best; they are of a close, firm texture, will carry a sharp arris, and weather well; in colour they are cherry red. No. ones T. L. B.’s are good bricks, though less firm than Farehams, but of an even texture; they are divided by colour into two classes—cherry-red and orange tint. The orange is generally used, as they contrast well with the red building bricks, but will not carry so sharp an arris or weather so well as the darker bricks.

“Gauged work” is often objected to on the ground that it will not resist the action of the weather. This we can refute by our own ex-

perience, for we have taken out old "gauged" arches in malms that have withstood for forty years the acids contained in London smoke, and have shown no signs of decay or disintegration. We can cite another instance of the indurating properties of "gauged work" in white Suffolks when exposed to the action of the atmosphere. During the erection of the Rackham Street Marylebone Infirmary, some geometrical windows in these bricks had to be cleaned down some three or four months after erection. This process had to be done by rasping the face of the brickwork, and so hard had got the bricks that it was with difficulty that an impression could be made at all, the rasps sliding off the work and leaving a black mark! Bricks in this condition are said by bricklayers to be case-hardened.

This so-called case-hardening we attribute to the process of setting. In good setting the bricks are always soaked (not to saturation) in water, which in a building in course of erection always contains more or less lime in solution, which is taken up by the brick while soaking, and by exposure to the atmosphere becomes carbonised and forms a hard skin, as it were, upon the face of the brick. Rubbers are purposely made much larger than the ordinary building bricks to allow for cutting and gauging them four courses to the foot, though as a rule they will not hold out or bed more than  $11\frac{1}{2}$  inches with close joints. T. L. B.'s as they come from the brickfield measure  $10\frac{1}{2} \times 4\frac{7}{8} \times 3\frac{1}{8}$  inches.



They are also obtainable 12 inches long, but bricks this length are only required for Camber arches, or Gothic arches whose bed joints radiate from the centre, as in Figs. 57 and 58, in which so much of the brick is cut away to form the long bevels on the soffit and crown, that the ordinary sized bricks will not "hold out" to the required lengths, and have therefore to be lengthened, where necessary, by forming the long "stretchers" out of two three-quarter bricks (this will be best understood by examining a few actual camber arches); to obviate which, the 12 inch bricks are made.

#### SETTING.

In setting "gauged work" the joint is taken up by absorption by holding the bed of the brick in contact with the putty, which must have the proper consistency and be kept in a small putty-box made with a level top, so that the setter can rest or steady his arm upon it while "dipping" his brick. Before putting the brick in place, the putty is scraped off the middle of the "bed," that it may set or joint more evenly. The joint should not be touched after the brick is "bedded," but should be left full like a small bead. Stone lime should be used for setting, as chalk lime is not fit for out-door work. Axed-work is generally set with putty and cement. If the work has to be carved deeply, it is best to build it all "headers," and "grout" it in solidly at back with Portland cement, that the bricks may not

break up or get disturbed under the chisel of the carver.

### DRAWING AND CUTTING ARCHES.

This forms a very important branch in the trade of the bricklayer, and a thorough knowledge of it is indispensable to the operative who would be master of his trade. In this section we will endeavour to make clear not only the setting out of the various arches, but how to take off the bevels and moulds, and apply them to arch-cutting.

An understanding of this will not be so difficult as may at first sight appear. The tools required for this work are—the rubbing-stone (which should not exceed in diameter 14 inches), hammer, boaster, Scotch, scribe, and tin-saw. The scribe is a small tin saw, used for marking the beds and bevels on the bricks.

### THE BULLS-EYE

Should have four keys, *a*, *b*, *c*, *d*, which when possible should be “stretchers;” but as this cannot always be done unless by very much reducing the size of the courses (technically called *voussoirs*), they are, therefore, frequently put in as in Fig. 52. The face mould for this arch is obtained by making a wooden pattern, as at *d*, on which the actual length of the brick is marked, and also its bevel, which

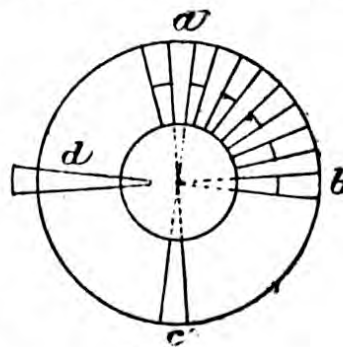

Fig. 52.

is taken off the drawing by placing the stock of the bevel along the bed joint, and moving the blade until it coincides or is in line with the soffit of that particular brick whose bevel is required. All the courses have the same bevel and the same length. It is usual to have two moulds made, so as to trace or traverse the courses round the arch, to ensure that the key brick will come in rightly (though one mould and two parallel straight edges would do equally as well); for if the mould be in the least inaccurate, the inaccuracy will be transmitted to each brick, and this multiplied by the number of courses in the arch (in this case 36), supposing the inaccuracy to be  $\frac{1}{16}$  of an inch, would amount to  $2\frac{1}{4}$  inches, in all probability the thickness of a course. Having proved the moulds, the pattern brick or soffit is marked lower down on the mould, that the brick when cut will be the thickness of a joint less than the brick shown on the setting out. The bevel of the thick end or *extrados*, as it is named, is the same as that of the soffit.

The arch cutter will find it most convenient to have a square piece of wood,  $4\frac{1}{2}$  by 9 inches, with parallel sides, which held flush with the soffit will give the exact place and bevel of the cross joint, and held longwise the length of the brick and its end bevel.

In cutting, the first operation is to square the bed and face of the brick, after which the soffit is bevelled. The brick is then placed on a bedding



down to the skewback, increasing or diminishing the thickness of the brick as may be required by raising or lowering the mould.

### THE CAMBER ARCH.

Fig. 54 is a camber, 12 inches deep, in Flemish bond. The skewback is obtained by taking in

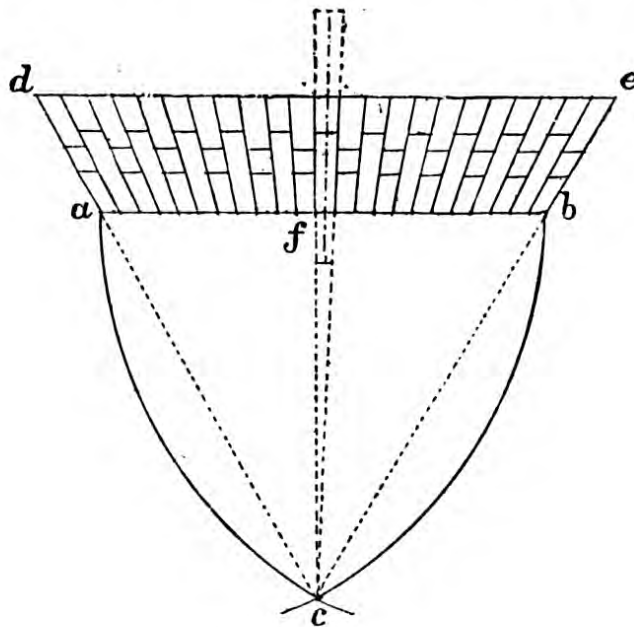

Fig. 54.

the compass the distance  $a b$ , and from these points, with  $a b$  as radius, drawing the inverted Gothic; a line from  $c$  through  $b$  will be the line of skewback, or springing. To draw this arch when the skewback is given—say  $4\frac{1}{2}$  inches from the centre line—set off the distance between the reveals; 12 inches above the springing, draw the line  $d e$ , and from centre line along  $d e$  measure off a distance  $4\frac{1}{2}$  inches beyond the reveal; from this point draw a line through  $b$ , intersecting the

central line in *c*. On *d e* measure off  $1\frac{1}{2}$  inch each side of the centre line, or whatever a brick with its joint will measure. Lines drawn from these two points to *e* will represent the key, and also the face mould. Make two moulds 9 inches ( $4\frac{1}{2}$  inches at each end) longer than the key. With the mould, shown by dotted lines, upon the key, on one of its edges, *f*, where *a b* meets it, make a pencil mark. Put the other mould on top of this and transfer the mark to it. With the two moulds, keeping the pencil mark always on the line *a b*, traverse the courses in down to the skewback as described in the bulls-eye. Take off the bevels, starting from the skewback, and pencil them upon the mould, 1, 2, 3, and so on, as shown in Fig. 55, *a*, which is a mould with the lengths

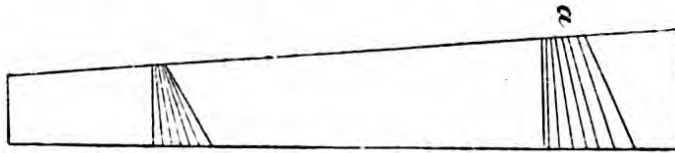

Fig. 55.

and bevels of each course upon it. One-half only of the arch need be set out. The cross joints may be cut in the courses with the saw and parallel board, as previously described, always working from the soffit. For greater accuracy and distinctness, the bevels may be pencilled on the back of the mould, at the top end, keeping them some little distance apart, and numbering them as already described. The courses may be traversed in by working from the top line *d e*, instead of from the soffit, marking on the mould,

downward from the top mark, the length of each course. Having thoroughly understood the setting out and cutting of this arch, no difficulty will be experienced with any of the ordinary arches.

The soffit generally cambers  $\frac{1}{8}$  of an inch to the foot.

The camber is not suited for large openings, or where any considerable weight has to be carried, as it is in reality not an arch at all, but simply an arrangement or *scheme*.

### THE GOTHIC ARCH.

Bisect the line  $a b$ , Fig. 56, with  $c d$ , and draw

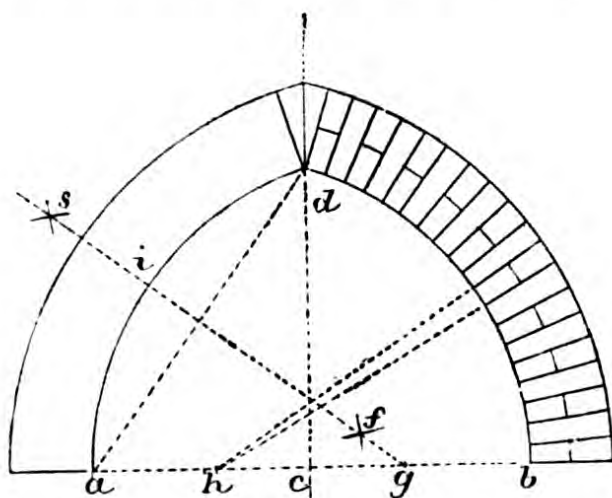

Fig. 56.

$a d$ ; from these two points with the compass opened to more than half their distance draw the arcs  $s f$ . Through their intersections draw a line meeting  $a b$  in  $g$ , from which point with the compass opened to  $a$ , draw the curve  $a i d$ , and by extending the compass, its parallel curve. From

*h* draw the curves on the right-hand side. The bed joints radiate from *h* and *g*, as shown by dotted lines. To do away with the very wedge-shaped key, the joints are sometimes radiated from the centre, as in Fig. 57. This key is also

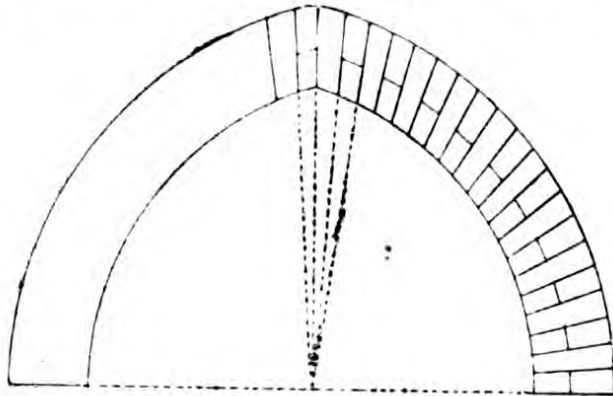

Fig. 57.

objected to by some on account of the oddness of its appearance at the key—a “stretcher” on one side and two “headers” on the other (this is what bricklayers call keying in with a joint), to prevent which a “birdsmouthed” key is used, Fig. 58. In the last arrangement the arch has an odd

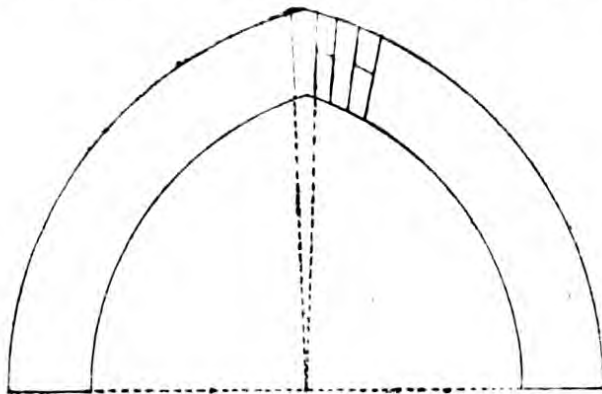

Fig. 58.

number of bricks, in the two former an even number. Fig. 56 is made up of two segments of



a circle, and the mould is obtained in the same way as that for the segment. The moulds for Figs. 57 and 58 are obtained in the same way as that for the camber, the bricks being all of a different bevel and length. These like the camber are *schemes*, not arches, as the bed joints do not fall within the *lines of radii*.

### THE ELLIPSE GOTHIC ARCH.

Divide the span  $a b$ , Fig. 59, into three equal

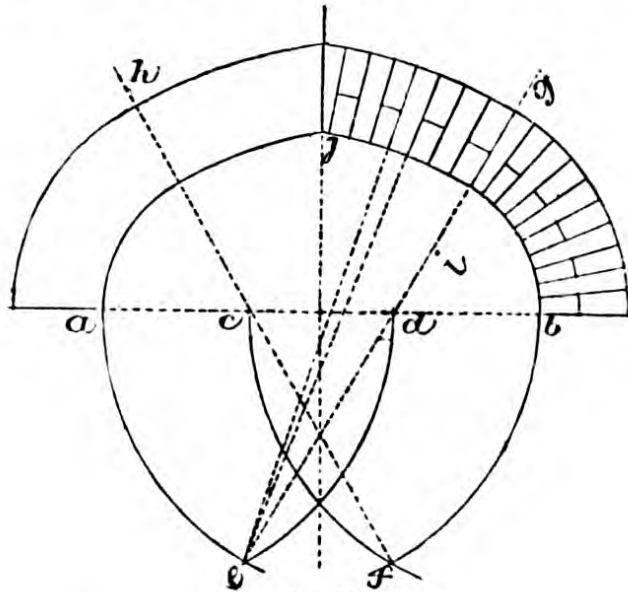

Fig. 59.

parts; take two parts in the compass, and with one leg fixed at  $a$  draw the arc  $d e$ , and from  $d$  the arc  $a e$ . In the same way draw the arcs  $b f$ ,  $c f$ . Through  $e$  and  $d$  draw the line  $e g$ ; through  $c f$  the line  $f h$ . With  $d$  as centre, radius  $d b$ , draw the arc  $b i$ , and from  $e$ , radius  $e i$ , the arc  $i j$ . The points from which the joints radiate are shown by dotted lines. Two different face moulds are required for this arch.

## THE SEMI-ELLIPSE ARCH.

Divide the span  $a b$ , Fig. 60, into two equal

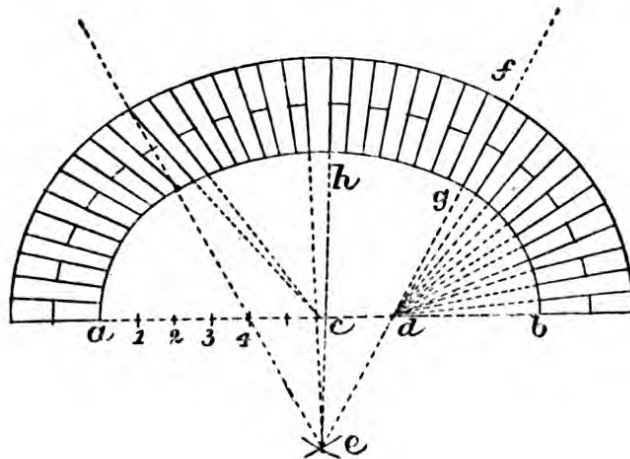

Fig. 60.

parts,  $a c$ ,  $c b$ , and  $a c$ , into six equal parts, 1, 2, 3, 4, &c. From  $c$  towards  $b$  measure off two of those parts, and with the distance  $4 d$  in the compass, and one leg fixed at 4, draw an arc cutting the centre line in  $e$ . Through  $e d$  draw the line  $e f$ ; with  $d$  as centre, radius  $d b$ , draw the arc  $b g$ , and from  $e$  with radius  $e g$ , the arc  $g h$ . Two ways are here shown of putting in the courses—one in which the joints radiate from their centres or foci  $d e$ , the other from  $c$  the centre of the opening. In the second method the lengths and bevels of each brick would be different. The first is an *arch*, the second a *scheme*, and is never adopted except in face work when, in the opinion of some people, it is desirable to have the courses all one thickness, even at the loss of strength. In the second method the mould, lengths, and

bevels are taken off in the same way as those of the camber.

### THE VENETIAN ARCH.

This so-called arch, Fig. 61, is made up of the

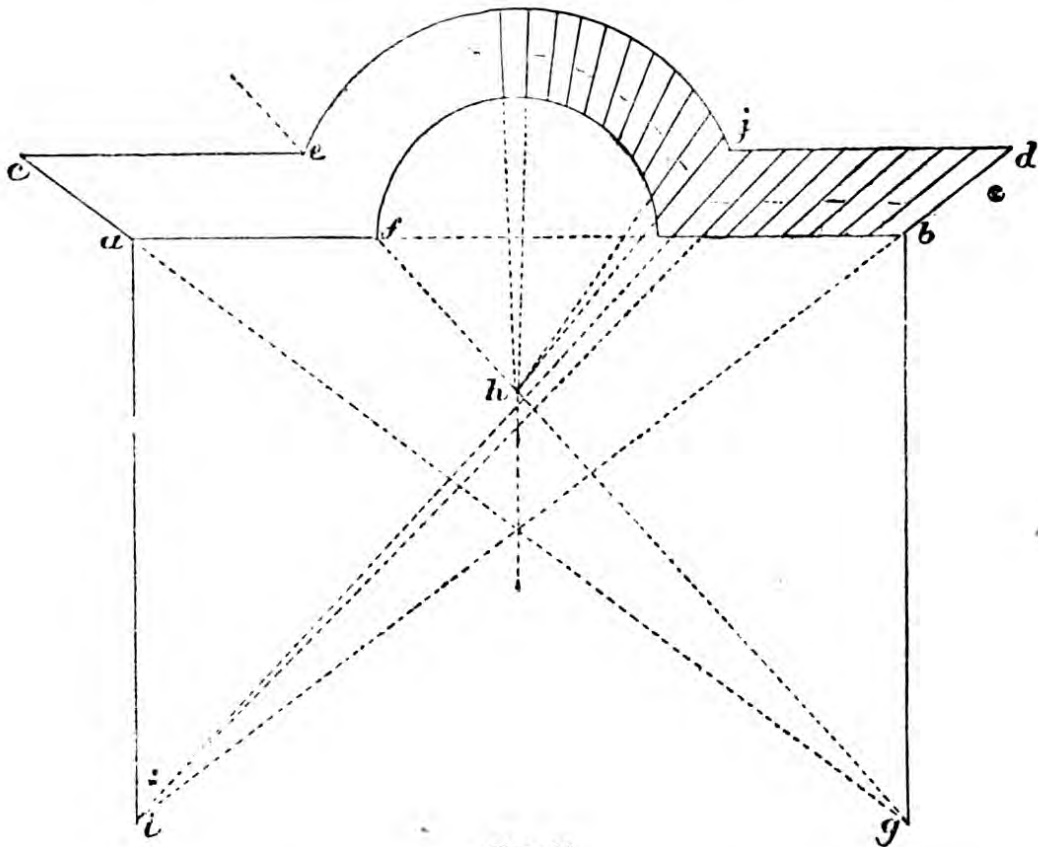

Fig. 61.

camber and semi, and was a few years ago very much used in the construction of three-light windows, sometimes with and sometimes *without* supporting mullions. Without mullions it is a very weak construction, and incapable of carrying much weight. But in this case it is generally allowed to have a bearing on the head of the solid window frame by showing less than  $4\frac{1}{2}$  inches



One would think that its ugliness and want of truth would entirely forbid its use. It is treated by the cutter in the same way as the camber arch.

### THE SEMI-GOTHIC ARCH.

To draw the semi-Gothic, Fig. 63, bisect (divide into two equal parts) the line  $a b$  with the perpendicular  $c d$ , and having determined the height of the apex  $d$ , from  $d$  draw the line  $d b$ , and from these two points the arcs through which the line  $e f$  passes, intersecting the cord  $a b$

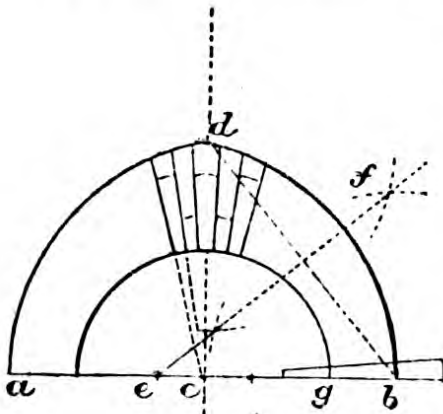

Fig. 63.

in  $e$ . Now with the distance  $e b$  in the compass draw the Gothic or outside curve. Repeat this operation on the other side and the outline of the arch will be drawn. To fill in the courses divide the soffit or semi into equal parts, whatever a brick will work or "hold out," and from the centre  $c$  through these parts radiate the courses as shown. The moulds are taken off as described in the bullseye, and traversed from the key downward to the springing, taking care that the soffit mark on the mould always comes on the soffit of the arch. Having done this, mark on the mould the length of each course, which will also give the bevels of the top ends of the courses. The mould is shown on the springing course with the length and the

outside bevel marked on it; *g* is the soffit mark to cut to; allowance must be made for the joint.

GOTHIC ON CIRCLE ARCH.

Fig. 64 shows the way to set out the moulds

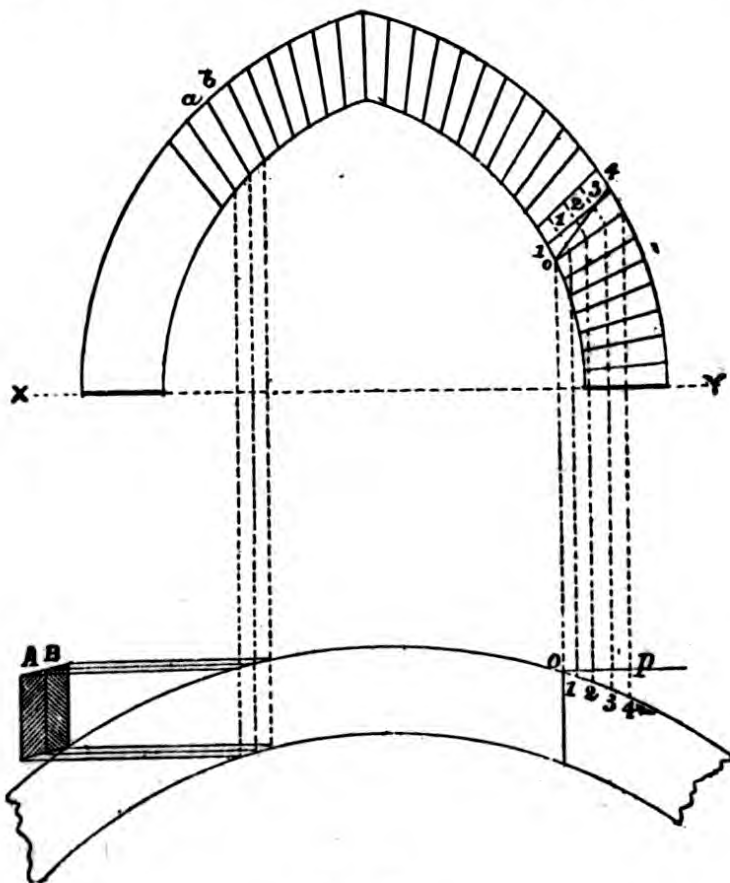

Fig. 64.

for a Gothic arch in a turret or bay that is circular in plan. Draw the elevation of the arch and the plan of the wall. A little consideration will show that the face of each course has a different curvature or "sweep," that at the springing having the greatest—equal to the wall itself—and the key the least, the curvature becoming

less as the courses approach towards an upright position. A separate section mould must therefore be obtained for each course. Divide the bed joint of the course  $o'$  whose curvature is required into a number of equal parts, from which drop lines square with  $x y$ , and intersecting the outside curve in  $o, 1, 2, 3, 4$  in plan. Draw  $o p$  parallel with  $x y$ , and transfer the distances 1, 2, 3, 4 from  $o p$  in plan to lines or ordinates square with the bed joint of the course whose curvature we are obtaining. A line drawn through these points will be the curvature of the section mould. By the same method the curvature of each course may be obtained.

#### TO FIND THE SOFFIT MOULD.

From  $a$  drop down the two left-hand lines passing through the circular wall below  $x y$ . From their intersection with the two curves draw lines parallel with  $x y$ . Take the thickness of the soffit in the compasses, and with one leg fixed anywhere in the upper line draw an arc cutting the lower line; these four points connected will give the soffit mould  $A$ . Moulds for two course,  $a$  and  $b$ , are shown; the others are obtained in the same way. This arch in practice is generally cut by rule of thumb, or what workmen call "near enough," and rubbed down to a suitable shape when the building is up, and its faults hidden with stopping of the colour of the bricks. But where perfect accuracy is required the moulds must be obtained as shown.

## SECTION IV.

## ORNAMENTAL BRICKWORK.

Ornamental brickwork in this country has reached its greatest height in connection with the Queen Anne style of architecture, as elaborated in the present day. The oriel windows of the Tudor, the ornamental gables and projecting chimneys of the Elizabethan, are all merged into it, and with such a profusion of carving as to be unprecedented in any former age. Indeed, to such an extent is this being carried as to call forth from Mr. Waterhouse, A.R.A., the assertion that we are fast departing from the vernacular of architecture. Let us rather say, if we may use the expression, that we have entered into the Augustan age of brickwork, in which the stuccoed front with its hidden carcass of "shuffs" and "place bricks"—often the refuse of the brick-field—is superseded by that which is what it appears to be, bearing on its face the unmistakable stamp of truth!

## THE NICHE.

Figs. 65, 66, and 67 are the elevation plan and section of a niche in Flemish bond. This is considered by bricklayers to be the most artistic piece of work in connection with their trade. There are two kinds of niches, the semi and the



elliptic. In the former it is circular in plan and elevation, in the latter it is elliptic in plan and circular in elevation. If that in our illustration be understood, no difficulty will be experienced with

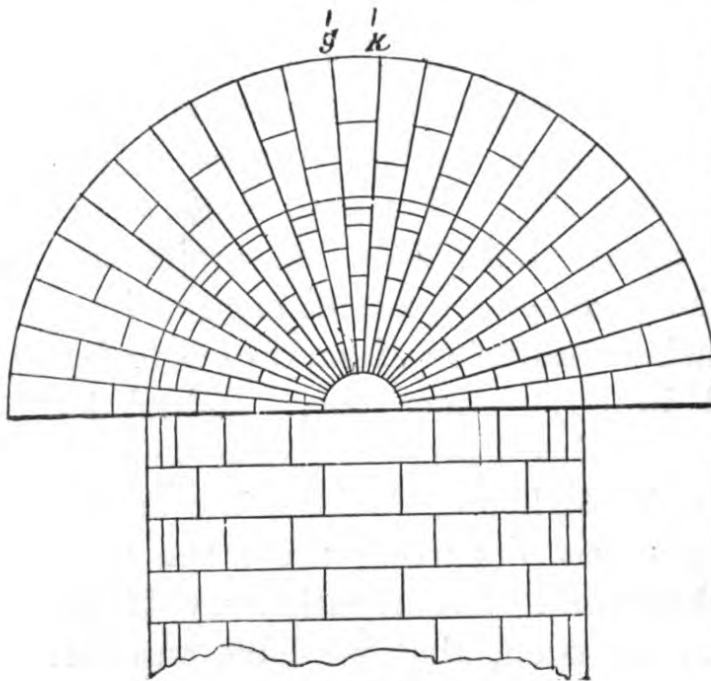

Fig. 65.

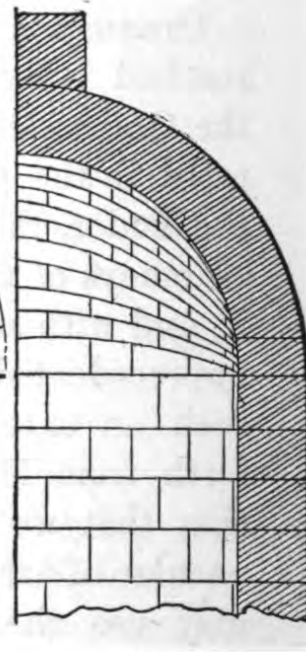

Fig. 67.

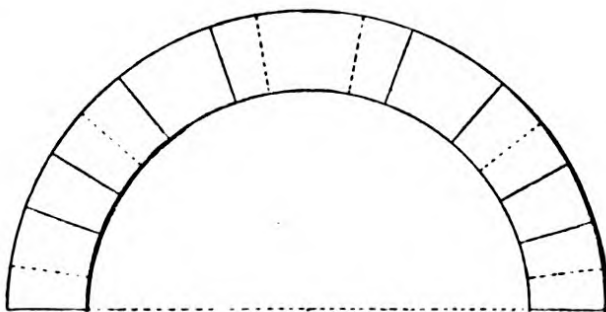

Fig. 66.

the others. The back or upright part is built to a template forming a semicircle, and the bond set out as shown on plan Fig. 66, the joints of one course being shown by thick lines, and those of the

course below by dotted lines. But it is the hood, the more difficult part, that we wish to explain. To make the centre, two pieces of wood, each a semi of the same circle as the niche, are nailed together with brackets in the internal angle (Fig. 68), and the space between the brackets filled in with core, pieces of bricks and mortar, and the surface finished with plaster of Paris, by means of a template a little more than a quarter of a circle (called the generating circle) fixed with a gimlet to the back of the bottom semi. The

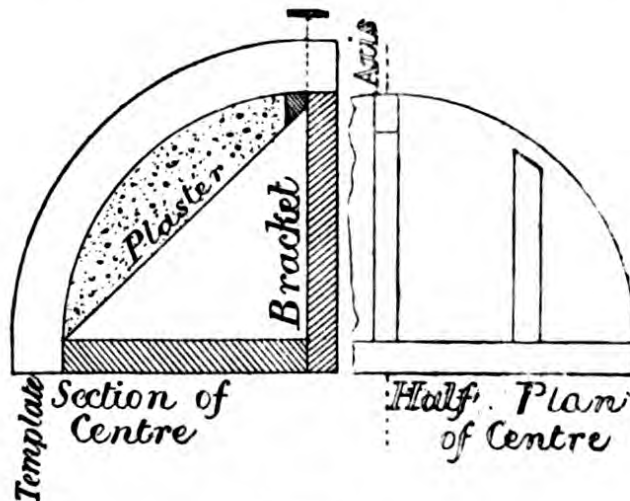

Fig. 68.

template rotating upon the gimlet as an axis, with the other end of it carried round the edge of the upright semi, a quarter of a sphere will be described or generated.

We have now got the centre or turning piece. Next draw the front arch as an ordinary semi arch, and mark the same number of courses on the top of the centre to represent the soffits. Then with

a plianth straight-edge or the rotating template, mark the courses on the plaster centre, all meeting in a needle-point where the gimlet entered; but as the bricks cannot be so finely cut, a small semicircle or "boss" is introduced of such a size that the bricks at the points where they meet it will be in thickness about half an inch. The courses are all of the same length and bevel, and the soffits must be bevelled in the same way as those

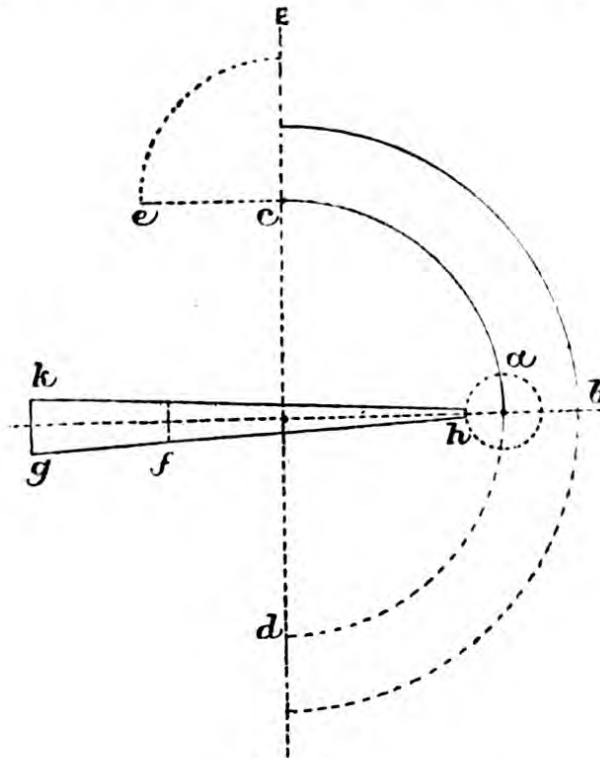

Fig. 69.

of an ordinary semi arch; and by looking at the elevation and section we see that the hood is made up of a series of semies increasing in size from the "boss" to the face arch.

THE NICHE MOULD.

The length of the course must be measured from where it meets the "boss" to the outside of the 9-inch face arch. From *h*, Fig. 69, draw a line square with *c d*, and on it mark a distance *f h* equal to the arc *a c*, and from *f* a distance *f g* equal to *c e*, making *g k* equal to *g' k'* in elevation (Fig. 65); connecting these two points with the circle *h* we obtain the mould. The length of *c a* is obtained by dividing it into small spaces and transferring them along the line *h f*; *f g* is the length of the key brick, and is shown turned up into its proper position *c e*.

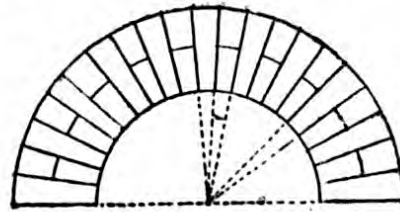

Fig. 70.

MOULDED COURSES.

It is the work of the bricklayer to cut and form all kinds of mouldings, dentils, entasis columns, flutings, and such like members in gauged work, leaving the more intricate, such as design and foliage, to be executed by the carver. Fig. 71 shows the kind of box that is used for cutting moulded bricks to any required section—in this case an ogee. The box is generally made to hold two headers or one stretcher. The brick or bricks, having been squared and rubbed down to the required thickness, are placed in this box and with the bow-saw roughly cut out, and then rubbed down to the section of the box with a

rasp, and sometimes a piece of straight gas-pipe to form the hollow members, the bricks being

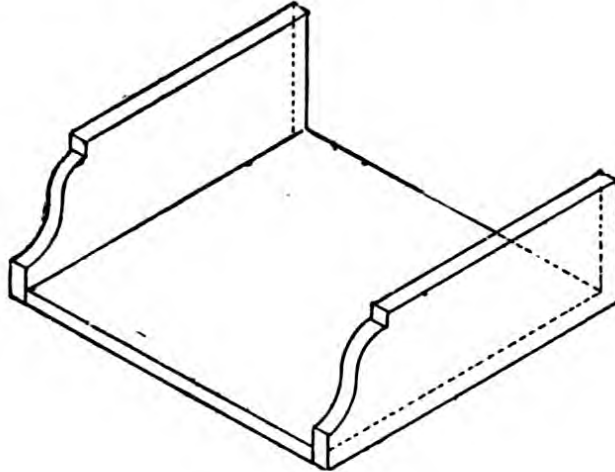

Fig. 71.

very soft. Care must be taken that the bricks be not wedged up or cramped too tightly in the box so as to "flush" the edges; and here we might mention that it is sometimes advisable to work the bricks a little wide, that in case of "flushing" they may be brought up to an arris by a rub or two on the stone. The cross piece or pieces on the top of the box are omitted for the sake of clearness.

#### ORNAMENTAL ARCHES

are those that have moulded soffits; and in such as the semi and segment, and in fact all that have the courses to one bevel, the moulding may be worked square, and applying the face mould cut in every respect similar to an arch with a square soffit. In this case one bed (the bottom one) will be square with the soffit,

and the other very much wedge-shaped. The courses must be cut rights and lefts, but the key and two springing bricks must be wedge-shaped from both beds, otherwise they will want bedding up with large joints to fit the centre, and thus spoil the appearance of the arch.

When a camber, or any arch whose courses have different bevels, has to be moulded on the soffit, the bricks must *first* be bevelled and afterwards moulded, and, lastly cut to the required shape and length by the application of the face mould, as before described.

#### THE ORIEL WINDOW

belongs peculiarly to ornamental brickwork (stone constructions being entirely excluded from this work), and we may add red brickwork. The first thing to be considered in connection with the oriel is its counterbalance. In all heavy projections in brickwork York flagging stones are employed; they are built into the main wall from which the projection starts, projecting to a distance suitable for the work. The weight of the projection on the stones is counterbalanced by the greater weight of brickwork on the other ends of the York slabs. But in the present case a girder or rolled iron joist, running in the direction of the wall line, and entering some 12 inches into the brick wall forming the side jambs, would have to be placed sufficiently low to allow the floor boards to pass over it. The flags and the weight upon them would be counter-

balanced by the girder. The principle of counterbalance is known to bricklayers by the name of "tailing down."

The whole of the oriel (Fig. 72) as shown

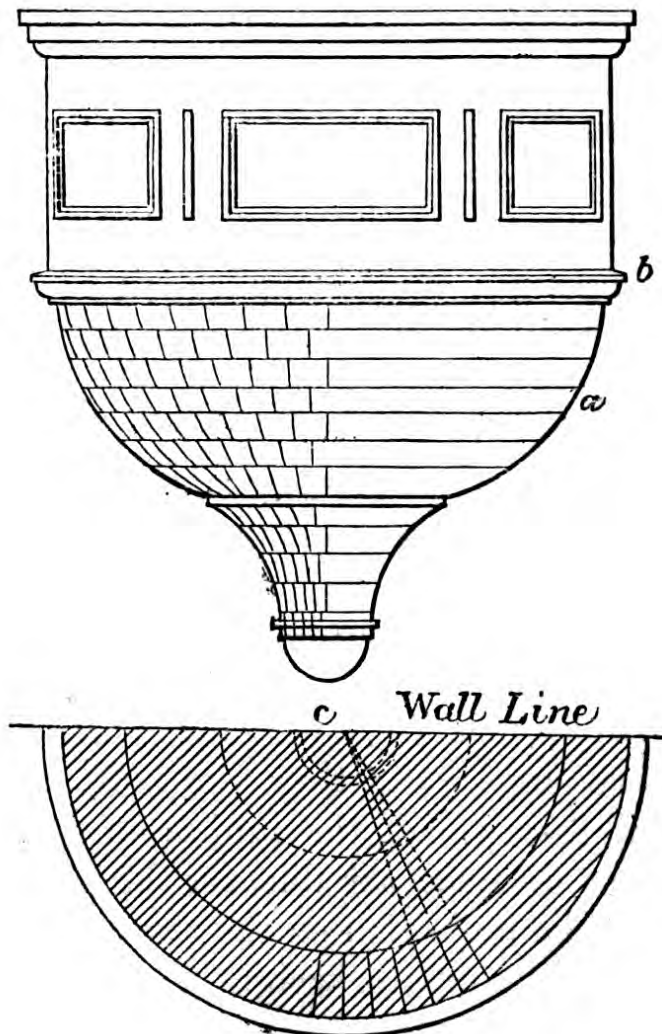

Fig. 72.

would be in brickwork, "gauged" and set in putty. The projecting courses, as the moulded string *b*, and the window-sill would be covered with 5-lb. lead, slightly projecting to form a drip for the water or rain.

The base here shown would be surmounted with mullions in brick or wood (most likely wood on account of its comparative lightness), and finished either with a semi-coned tiled roof or a balustrade. Windows of this type may be seen at Carlyle House, Chelsea Embankment; and the Agnew Picture Gallery, New Bond Street.

The bricklayer when setting out the work must strike all the successive courses from one point, *c*, regulating the length of the radius-rod for each course. Each course must radiate from *c*, as shown in plan, and the face of each brick be worked to the required sweep or curve. The bevels (which will be different for each and every course) will be obtained by placing the stock of the bevel on the line representing the bed, and bringing the blade to coincide with that portion of the curve representing the course we are about to cut. Let the bevel of the course marked *a* be required. Place the stock of the bevel on the third line below the moulded string *b*, and shift the blade until it fit the curve of the course *a*. The bevels for each course must be obtained in the same way. The plan in this figure may be considered as a horizontal section just above the string course *b*.

#### ORNAMENTAL GABLE OR PEDIMENT.

Figs. 73 and 74 are part front and end elevations of an ornamental gable or pediment. The moulding is composed of the members known as



the ovolo, the cavetto, and the ogee. In ornamental brick copings it is usual to form the top fillet with two courses of red tiles, well soaked and closely and neatly set in cement, with the

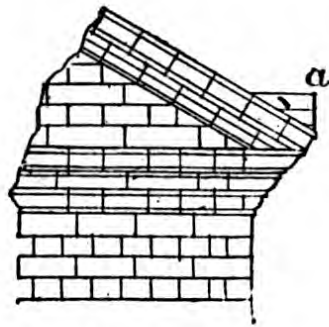

Fig. 73.

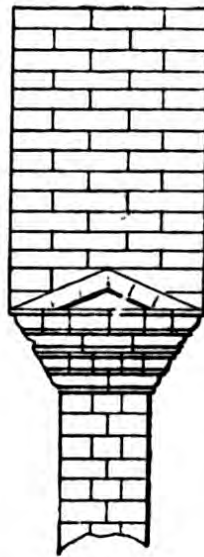

Fig. 74.

joints properly broken, as here shown. Sometimes lead is substituted for tiles. Here we have shown a kneeler, *a*, but in practice the tiles are more frequently brought down to the bottom of the coping, the kneeler being dispensed with.

### GOTHIC WINDOW.

Fig. 75 is a two-light ornamental Gothic window with 2-inch beaded or chamfered reveals. The whole of the work under the large arch would be recessed back from the general wall line. The side piers A and B for uniformity sake might be built in half bond, similar to that

of the 9-inch mullion ; but the proper bond would be to start from the reveal with a header and closer, the same as that shown on the reveal under the large arch. The tympanum is filled in

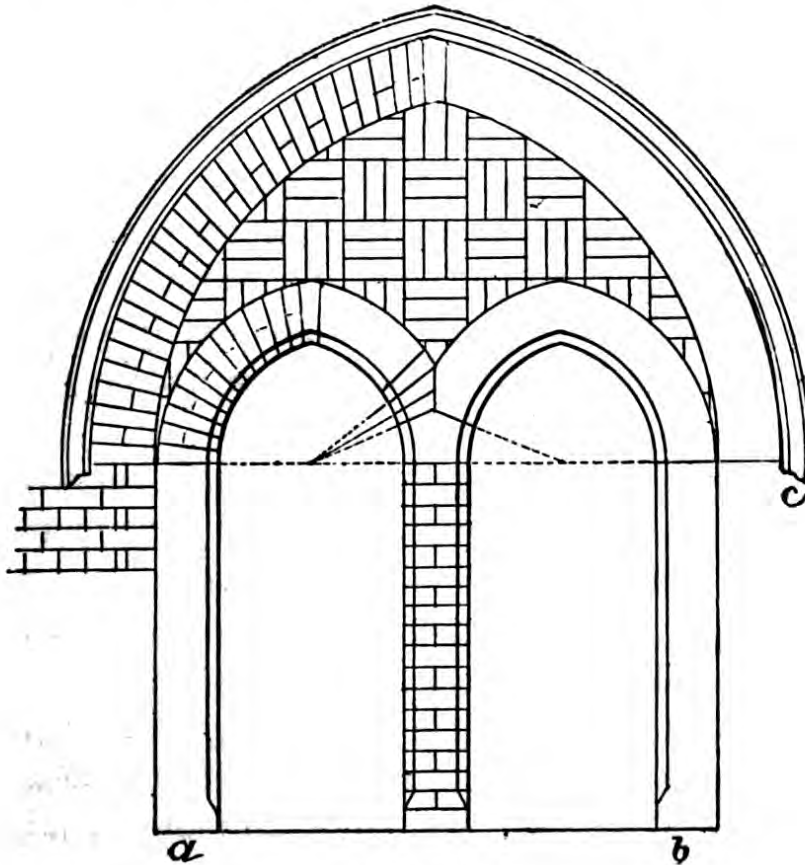

Fig. 75.

with  $4\frac{1}{2}$ -inch work in 9-inch blocks, each block being made up of three bricks, and called "blocking courses."

The label *ce*, enclosing the large arch, for the sake of contrast, might be in Portland stone. The whole of the work here shown, excepting the reveals of the large opening, might be in "gauged" work or in "axed" work ; or the arches alone

might be "gauged" or axed, with the tympanum filled in with good building bricks, selected for colour and shape and neatly pointed, making a very effective as well as economical ornamental feature.

The saddle-back springer on the mullion might with advantage be in stone. Windows of this kind may be built for cased frames with sliding sashes, but they are more generally built in neat work inside and out, with 9-inch jambs, grooved to receive lead lights. Ornamental brickwork is a subject in itself, that to adequately describe would require more space than can be given to it in a treatise of this dimension.

Mr. Ruskin, advocating the use of ornamental brickwork, says: "Here let me pause for a moment to note what one should have thought was well enough known in England, yet I could not, perhaps, touch upon anything less considered—the real use of brick. Our fields of good clay were never given us to be made into oblong morsels of one size. They were given us that we might play with them, and that men who could not handle a chisel might knead out some expression of human thought. In the ancient architecture of the clay districts of Italy, every possible adaptation of the material is found, exemplified from the coarsest and most brittle kinds, used in the mass of the structure, to bricks for arches and plinths, cast in the most perfect curves, and of almost every size, strength and hardness; and moulded bricks wrought into flower work and

tracery as fine as raised patterns upon china. And just as many of the finest works of the Italian sculptors were executed in porcelain, many of the best thoughts of their architects were expressed in bricks, or in the softer material of terra-cotta ; and if this were so in Italy where there is not one city from whose towers we may not descry the blue outline of the Alps or Appennines—everlasting quarries of granite and marble—how much more ought it to be so among the fields of England.”—*Stones of Venice*, vol. ii., p. 260.

## SECTION V.

## ROOF-TILING, POINTING, Etc.

## TILING.

TILING is a branch of the bricklayer's trade, and owing to the rage for red-brick buildings is now very much in use. One advantage of the tiled roof is that it is cool in summer and warm in winter, but on account of their weight stronger timbers are required than for slates. The Broseley tiles are considered the best; they are  $10\frac{1}{2}$  inches long, 6 inches wide, and  $\frac{3}{8}$  of an inch thick, and have three nibs or projections at the head for hanging. Good tiles are fairly smooth and slightly vitrified. Those of a bright red or clayey colour, with no vitrification, are absorbent, and not so capable of resisting the weather. Six kinds are used in good work, viz. under-eaves or three-quarter tiles, plain tiles, hips and valleys, ridge tiles and tile-and-a-half, the last being used for cutting up to valleys and hips, and forming gables, so as to do away with the half tile that would be required to break joint. Valley and hip tiles are purposely made to suit the angles of the roof. As the tiles come to the hand of the tiler he should throw out the straight ones to be used by themselves, while those that have a hollow bed should be also kept by themselves, as the straights will not lie close on the hollows. Good tiling is characterised by the tails of each course fitting closely upon the backs of the course below it; by the cross joints or "per-

pendents" running in straight and regular lines from eaves to ridge, the vertical joint between each two tiles coming immediately in the middle of the tile below them; by the hips and valleys being in the same plane as the sides of the roof of which they form a part. It is a common sight to see hips standing up above the roof, so as to have more the appearance of ridges than hips. As the tiles are ordered before the roof is on, the angles should be set out and sent to the tile-maker to insure getting them to the required angle. In our experience we have frequently found that the contained angle has been guessed at or obtained by some "rule of thumb," and with the consequence that generally ensues from such work, viz. that the angle contained within the hip tile has been either too acute or too obtuse.

Tiles are either laid dry on close boards, with battens above for hanging them, or on open battens, in which case they should be bedded in lime and hair mortar. The most modern and improved way of hanging is shown in Fig. 76. The boards are 6 inches wide and are feather-edged, the top edge being  $\frac{3}{4}$  of an inch thick. Here we have a boarded roof without battens, and one that will keep out the weather if the tiles should get broken, for the rain would cause the wood to expand, and thus tighten the joints of the boards, to the exclusion of all rain. The first course—the eaves and under-eaves—should be bedded in hair mortar. The "lap" (the distance that the tail of the third tile overlaps the head of the first) should be

3 inches. The "gauge" (the distance between the tails of two consecutive courses) can always be ob-

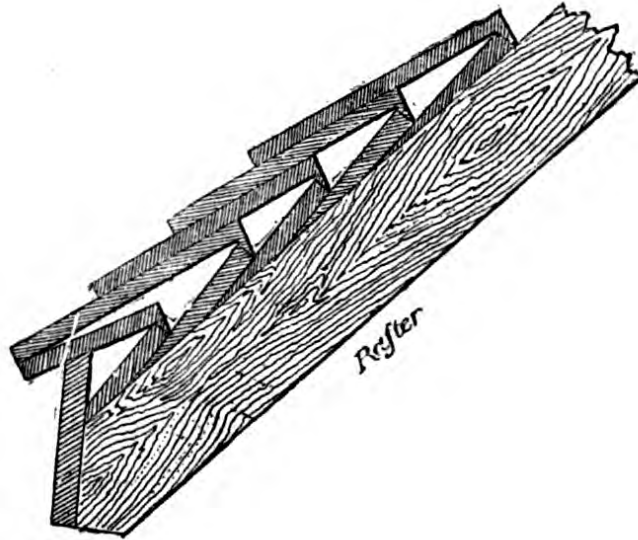

Fig. 76.

tained by dividing the length of the tile (measured from the under side of the hanging nibs) less the lap by two. Thus,  $10\frac{1}{2} - 3 \div 2 = 3\frac{3}{4}$ , the "gauge."

#### ROOFS HAVING DIFFERENT PITCHES.

When roofs of different pitches intersecting in hips and valleys occur, the tiler has generally a deal of trouble, and consequent waste of time, through carpenters frequently insisting upon intersecting the battens; and very often after much time has been wasted, and a portion of the tiling done, it is found necessary to tear off all the battens to correct the error.

The following rule will prevent such an error.

Draw the plan of the two roofs (Fig 77), of different pitch, and from the centre of the valley set out two parallel lines, *a b*, *c d*, representing the true width of the tails of the valley tiles,

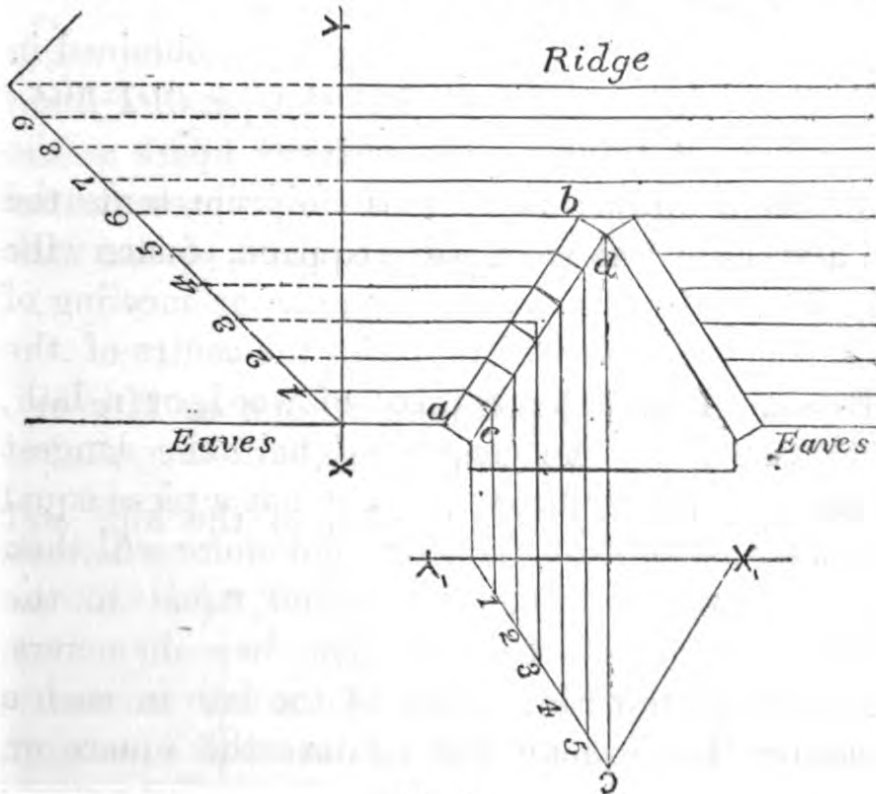

Fig. 77.

which is from  $1\frac{1}{2}$  to 2 inches. On *xy* at right angles with the eaves of the main roof draw its section, on which set out the gauge 1, 2, 3, &c., and drop lines square with *xy* and intersecting the line *ab*. From these points of intersection square the short lines across the valley, and from where they intersect the parallel *cd* draw lines square with *x'y'* and intersecting a section of the smaller roof. The distance between any two points on *y'g* will be the "gauge" for the smaller





hip. Draw  $ed$  square with  $ab$ , cutting the eaves, and from  $f$  a line square with  $cb$ ; with this as radius, from the point  $f$  draw the semicircle, and from where it cuts  $ab$  draw the lines  $eg$ ,  $dg$ ;  $egd$  is the angle required for the hip tiles, or in other words it is a section or cut through the roof at right angles with the hip. The angle for valley tiles is obtained in the same way, remembering that the hip is a salient angle and the valley a re-entering angle.

#### POINTING.

Pointing is divided into two classes, tuck-pointing and flat-joint pointing. In tuck-pointing the joints of the brickwork are filled in with mortar or stopping, of generally the same colour as the bricks, and rubbed down to a level surface with a piece of sacking or soft brick of the same colour as the work, and a putty joint made of lime and silver-sand placed upon it. Stone lime should be used for outside work.

The mode of working is to have a parallel rule from 8 to 10 feet long, 5 inches wide, and  $\frac{1}{2}$  an inch thick, with one feather edge and four cleats  $\frac{3}{16}$  of an inch thick tacked on to the back to afford room for the putty that is cut off to fall through. The putty is spread out on the rule from which the bricklayers, one at each end, take it off with their jointers, and with the rule against the wall, working on the top edge, transfer it to the wall. The ragged edges are then cut off with the Frenchman or knife, and the

loose particles brushed off with a soft brush. Tuck-pointing is not suitable for outside work, as the putty joints projecting beyond the general surface arrest the weather and are consequently soon destroyed, unless protected by heavy projections.

#### FLAT-JOINT POINTING.

This is the most general and durable kind of pointing. It should be made up of washed sand and stone lime several days at least before using it, that it may by retempering acquire toughness, which will add very much to its durability and facility of working. The joints should be finished flush with the work (excepting in "weather-jointing," when the top of the joint should be kept back  $\frac{3}{8}$  of an inch, and the bottom flush to shed the rain) and neatly cut off top and bottom with the Frenchman, and brushed off. To ensure good pointing, the work should be well raked out and wetted not sparingly. If the joints are deep they should be filled in by going over them twice with tolerably stiff mortar to prevent cracking, and the work done with *pointing trowels*. Jointers should not be used under any pretext. In first-class work the pointing is done as the work proceeds during erection, and forming one body with the building will, if the mortar be good, last for many years.

Malm work for tuck-pointing is generally stopped in with mortar, coloured with yellow ochre (2lbs. of ochre to each hod of mortar), but it

will be found best to use *no* colour in the stopping, as by its earthy nature it very much injures the setting and hardening properties of the lime, which in a great measure accounts for so much pointing perishing soon after it is done. Stop the work in with good mortar, as described in flat-joint pointing, and rub it down with a soft malm, leaving the dust on the work, and with a soft stock brush go over it lightly with hot alum water. One pound of alum to 3 gallons of water.

White Suffolk bricks for tuck-pointing, are treated in the same way, rubbing the work with a soft white Suffolk instead of with a malm.

Red work for tuck-pointing is stopped in with mortar coloured with Venetian red and Spanish brown, with sometimes a little vegetable black added. The colour of the stopping must be determined by the colour of the bricks, so as to match them. It is best to avoid colouring the bricks, but when stopped in rub them down with a soft brick, and apply alum water or white copperas, as already described. One pound of copperas to 3 gallons of water. The appearance of red brickwork is often spoilt through the application of colour.

To clean down red work, mix a pint of spirits of salts with a pailful of water. This applied with a stock brush will leave the work clear of all lime spots, &c. It may be done on work recently erected, in which the joints have been struck during erection, and without injuring them.

Copperas is very much used in connection with

stock work, especially when the bricks are inferior or of a bad colour. One pound of green copperas is melted down with every 5 gallons of water. It should be mixed several days before required, and enough made to finish the job, that it may be all one colour. A small nob of lime mixed with the copperas very much heightens its colour. The copperas should be tried on the work to match it before being generally used, and weakened down by the addition of water if found necessary.

#### BURNING CLAY INTO BALLAST.

The use of burnt ballast is increasing every day, both for purposes of mortar and concrete. The chief reason for this is its cheapness in comparison with the cost of sand, for while sand costs from 5s. to 7s. a cube yard, varying according to the locality, burnt ballast can be produced, including all materials and digging of clay, with a run of about 60 yards, at 2s. 6d. a cube yard. While we *reiterate* that for mortar nothing better than clean sand of a sharp angular grit can be used, we do not wish to be understood as condemning the use of burnt ballast. Thoroughly burnt and cool, with the large aggregations (sponge-like lumps whose parts touch each other here and there, and are held in contact by vitreous matter) broken up, and the whole mixed with a fair proportion of Thames ballast or clean gravel (see previous remarks on this subject in Article on Concrete), is capable of making a good concrete, for the ab-

sorbent nature of the ballast attracting the silicates of the cement or lime, which entering the pores form so many threads or ties binding the whole mass together, and unlike Thames ballast, with its non-absorbent and smooth water-worn surfaces, which simply beds itself in the matrix with comparatively little adhesion.

Stiff or strong clay, just as it is dug up, is the best for burning, as it requires the least firing and will make the best ballast. The heap is commenced by forming a cone of clay, about 3 feet in diameter and 5 feet in height, formed round a piece of pole placed on end as a centre. Fires are then made round the cone by placing bricks on edge forming a channel leading up to the centre. These are filled with wood and coal, and covered over and cased with a layer of clay about 6 inches thick before lighting. As the fire burns through it must be drawn down, which is done by means of long-handled prongs made specially for the work, and strewn with small coal called "slack," and covered with another layer of clay. The thickness of the layers of clay may be increased as the work proceeds, until they become from 18 to 24 inches, not forgetting the sprinkling of "slack" on each layer of clay. Care must be taken that the fire be drawn down, as it naturally draws to the top, and the unburnt portions thrown up into the fire. When the clay is thoroughly burnt the fire will go out.

### BUILDING ADDITIONS TO OLD WORK.

When building additions to old buildings, it frequently occurs that the old work is found to be considerably out of perpendicular, generally overhanging. In such a case it is best to carry up with the new work, just where it joins with the old, a pier or pilaster, forming a break in the wall line, which will enable the bricklayer to keep the new work upright and hide the fault of the old, which otherwise would be exposed by junction with the new. The projection of the pilaster will of course be regulated by the amount that the work is out of the upright.

### FIRE-PROOF FLOORS.

Fire-proof floors are now very rarely constructed in bricks, being almost entirely superseded by tile arches brought to a level with concrete, or constructed with rolled joists and concrete alone, or with cement and breeze, but more generally with Dennett's Patent, which is a concrete composed of broken bricks and gypsum. But in very large warehouses, and where great weights have to be carried, the fire-proof floors are still constructed with brick rings carried on rolled girders.

SECTION VI.

APPLIED GEOMETRY.

Geometry of all studies is to the artisan the most attractive and useful. The problems given here are such as may be applied by the bricklayer to every-day practice, and therefore come within the meaning of the term *applied geometry*. But we would advise the young artisan not to rest satisfied with a knowledge of the few problems given herein, but to take up the subject as a separate study, and familiarise his mind with its principles, so as to be able to apply them generally and with understanding.

*To draw a square whose superficial area shall equal the sum of two squares whose sides are given.*

Let  $A B$  (Fig. 79) be the given sides. Draw

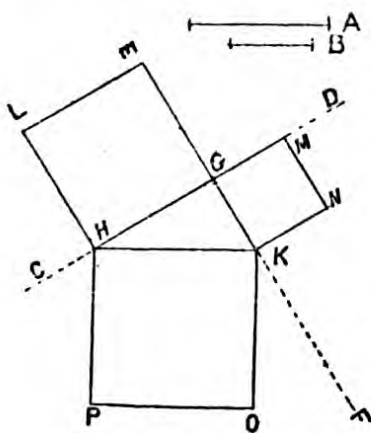

Fig. 79.

the lines  $c d, e f$  at right angles, and from  $G$  set off  $G H$  equal to  $A$ , and  $G K$  equal to  $B$ : a line drawn from  $H$  to  $K$  will be the side of the required square. On  $G K$  complete the square  $G M, N K$ ; and on  $G H$  the square  $H L E G$ ; and on  $H K$  the square  $H K O P$ . The area of this square will

equal the combined areas of the two smaller





*To draw an arc by cross-sectional lines.*

On  $ab$ , the span (Fig 81), erect the perpendiculars,  $de$ , equal to twice the required rise.

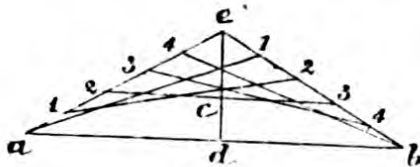

Fig. 81.

Divide  $ae$  into any number of equal parts, 1, 2, 3, 4, and  $eb$  into

the same number of parts, and draw cross-sectional lines as shown. A curve traced through the intersections will be the required arc.

Another method practised (we do not recommend its use) sometimes by carpenters for getting out turning-pieces for the bricklayer. Span 6 feet, rise  $1\frac{1}{2}$  inch. Divide the span into a number of equal parts, say six, and from the points erect perpendiculars, measuring upward  $\frac{1}{2}$  inch on the first, an inch on the second, and  $1\frac{1}{2}$  inch on the third, which in this case is the centre line. Treat the other half of the span in the same way, and with a flexible straight-edge fixed at the springing points  $ab$  (Fig. 81) force it upward until it stand over the distance marks on the perpendiculars, and with a pencil trace the arc or curve.

The foregoing methods do away with the necessity of laying down a large platform and getting out a long radius-rod; the camber, for instance, which is the segment of a circle described by a radius-rod of 70 feet  $2\frac{3}{8}$  inches in length.

*To describe a flat arc (camber for instance) by mechanical means.*

Let  $ab$  (Fig. 82) be the cord of the arc. Bisect

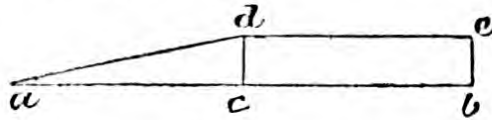

Fig. 82.

$ab$  at  $c$  by the perpendicular  $cd$ , and make  $cd$  equal to the height of the segment. Draw  $de$  parallel to  $ab$ , and make  $de$  a little larger than  $ad$ . This template should be got out of a piece of timber, and by moving the whole of the template, so that the two edges  $da$  and  $de$  may slide on two pins,  $a$  and  $d$ , the angular point  $d$  of the template will describe the segment required, and if the pin be taken out of  $a$  and put in the point  $b$ , the other portion  $db$  of the segment  $adb$  will be described in the same manner. This method should be practised in preference to the methods previously described.

*To find the joints of a flat arch without using the centre of the circle of which the arc is a part.*

Having determined the number of voussoirs or

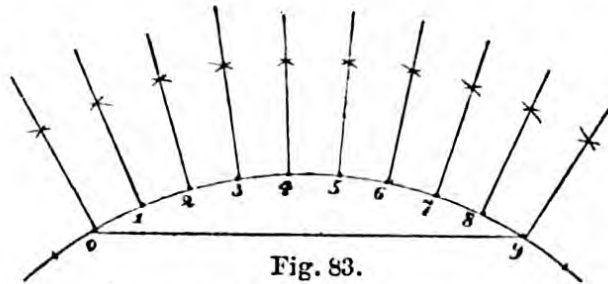

Fig. 83.

“courses,” 1, 2, 3, 4, &c. (Fig. 83), from these points

erect perpendiculars by intersecting arcs; these perpendiculars represent the joints. We need hardly to say that the practical application of this problem is to enable the workman to draw the courses or voussoirs in an arch similar to that given in the previous problem.

*To draw the joints of a semi ellipse arch with mathematical accuracy.*

The point  $D$  (Fig. 84) is the middle of the arch,

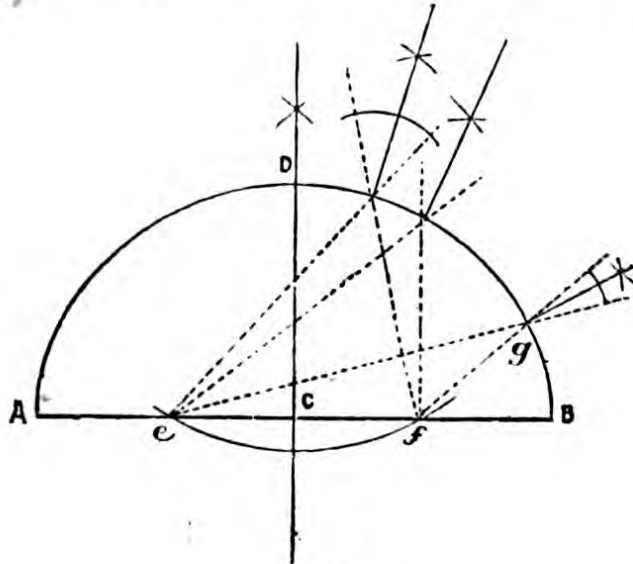

Fig. 84.

and the point  $c$  the middle of the springing line. With the distance  $cA$  or  $cB$ , from the point  $D$  describe an arc cutting  $AB$  at  $e$ , and also at  $f$ ;  $ef$  are the foci. Let a joint be required at  $g$ . From  $e$  and  $f$  draw lines passing through  $g$ , and bisect the angle they make with each other, and from the point  $g$  erect a perpendicular, which will represent the required joint. The other joints are obtained in a similar manner.



*Any two straight lines given to determine a curve by which they shall be connected.*

Let  $a b, c d$  (Fig. 86), be the given lines, and  $c b$

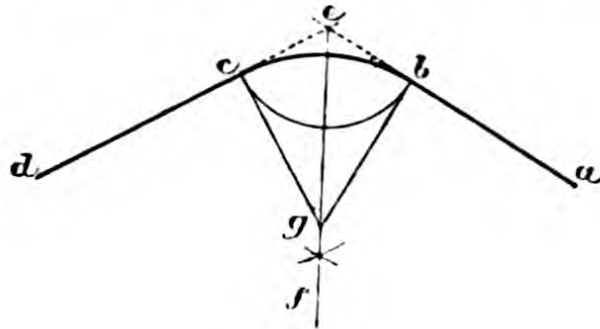

Fig. 86.

the points to be connected. Produce the lines until they meet in  $e$ ; bisect the angle  $c e b$  with the line  $e f$ ; from  $c$  and  $b$  draw lines at right angles to  $a b$  and  $c d$  meeting  $e f$  in  $g$ . From  $g$ , with distance  $g c$  or  $g b$  describe the connecting curve. The given lines may be taken as two brick walls that have to be connected or formed with a round corner.

Fig. 87 is an example in which the given lines

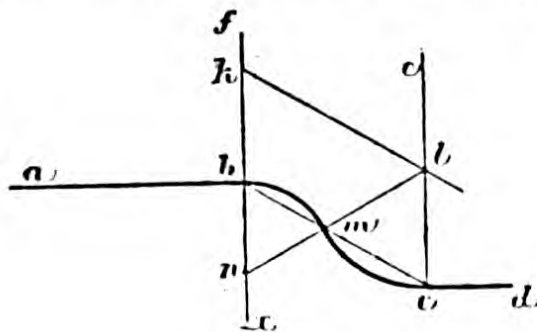

Fig. 87.

are parallel. From point  $b$  draw  $f x$  at right angles with  $a b$ ; and from  $c, c e$ , at right angles

with  $cd$ . On  $f$  mark a point  $k$  any distance from  $b$  less than  $bc$ . Draw  $kl$  through  $k$  parallel to  $bc$  and cutting  $ce$  in  $l$ . From  $l$  as centre with the distance  $lc$ , which is equal to  $bk$ , describe the arc  $cm$ . Join  $lm$  and produce it in the same straight line towards  $m$  to meet  $fx$  in  $n$ . From  $n$  as centre, with the distance  $nb$  or  $nm$ , describe the arc  $bm$ . The given straight lines  $ab$ ,  $cd$  are connected by the curve  $bmc$ .

If the given straight lines are not parallel, but would meet if one or both were produced, as  $gh$  (Fig. 88), produced meets  $ab$  in  $a$ , forming the

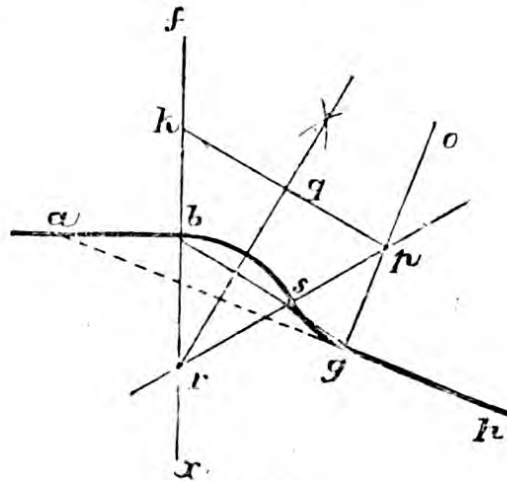

Fig. 88.

small angle  $gab$ , draw, as before,  $fx$  and  $go$  at right angles to  $ab$  and  $gh$  respectively. Take any point,  $k$ , in  $bf$ ; make  $gp$  equal to  $bk$ , and join  $kp$ . Bisect  $kp$  in  $q$ , and draw  $qr$  perpendicular to  $kp$ , meeting  $fx$  in  $r$ . Join  $rp$ , and from  $p$  as centre, at the distance  $gp$ , describe the arc  $gs$ , meeting  $rp$  in  $s$ . Then from the centre  $r$ , at the distance  $rb$  or  $rs$ , describe the arc completing the

curve  $bsg$ , by which the given straight lines  $ab$ ,  $gh$  are connected.

*To find the form or curvature of a raking moulding that shall unite correctly with a level one.*

Let  $abcd$  (Fig. 89) be part of the level

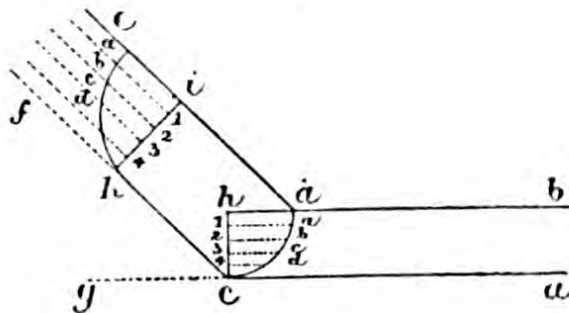

Fig. 89.

moulding (which we will here suppose to be an ovolo or quarter round),  $a$  and  $c$  the points where the raking moulding takes its rise on the angle,  $fcg$  the angle the raking moulding makes with the level one. Draw  $cf$  at the given angle, and from  $a$  draw  $ae$  parallel to it; continue  $ba$  to  $h$ , and from  $c$  make  $ch$  perpendicular to  $ah$ . Divide  $ch$  into any number of equal parts, as 1, 2, 3, 4, and draw lines parallel to  $ah$ , as  $1^a, 2^b, 3^c, 4^d$ ; and then in any part of the raking moulding, as  $i$ , draw  $ik$ , perpendicular to  $ea$ , and divide it into the same number of equal parts as  $hc$  is divided into; and draw  $1^a, 2^b, 3^c, 4^d$ , parallel to  $ea$ . Then transfer the distances  $1^a, 2^b, 3^c, 4^d$ , and a curve drawn through these points will be the form of the curve required for the raking moulding.



The method here shown is for an ovolo, but it would be just the same for any other formed moulding, as a cavetto, ogee, &c. This problem can be applied in the construction of pediments in "gauged" work.

*To describe an ellipse by means of a carpenter's square and a piece of notched lath.*

Having drawn two lines to represent the diameters of the ellipse required, fasten the square so that the internal angle, or meeting of the blade and stock shall be at the centre of the ellipse. Then take a piece of wood, or a lath, and cut it to the length of half the longest diameter, and from one end cut out a piece equal to half the shortest diameter, and there will then be a piece remaining at one end equal to the difference of the half of the two diameters. Place this projecting piece of the lath in such a manner that it may rest against the square on the edge which corresponds to the two diameters; and then turning it round horizontally, the two ends of the projection will slide along the two internal edges of the square, and if a pencil be fixed at the other end of the lath it will describe one quarter of an ellipse. The square must then be moved for the successive quarters of the ellipse, and the whole figure will thus be easily formed. This method is on the principle of the trammel. There are several other ways of drawing an ellipse, but for these the reader must be referred to a work on geometry.

*To draw a Gothic of any given height and span ;  
or, in other words, an Ellipse Gothic.*

Let  $AB$  (Fig. 90) be the span and  $CD$  the height. Draw the line  $AB$  and bisect or centre it at  $c$ ;

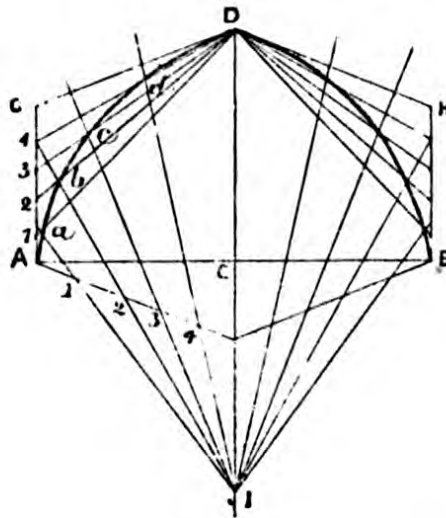

Fig. 90.

draw  $CD$ , and make  $ci$  equal to  $CD$ . Divide  $CD$  into three equal parts, and draw  $AG$ ,  $BH$  parallel with  $CD$ , and equal to two-thirds ( $\frac{2}{3}$ ) of  $CD$ . Make  $CF$  equal to one-third of  $CD$ , and draw  $AF$ ,  $FB$ . Divide  $AF$  into any number of equal parts, 1, 2, 3, 4, and from  $i$  draw  $i1$ ,  $i2$ ,  $i3$ ,  $i4$ . Divide  $AG$  into the same number of parts as  $AF$ , and draw  $1D$ ,  $2D$ ,  $3D$ ,  $4D$ , and the intersection of lines will give the points in the curve, which must be drawn by hand. The other half must be found in the same way.



mathematical formula our calculation would stand thus :

$$\left( \frac{a c^2}{c d} + c d \right) \div 2 = \text{the length of radius re-}$$

quired. Or in plain words  $a c$  square, divided by  $c d$ , plus  $c d$  divided by 2 equal the length of radius. In the above explanation we have gone out of the beaten track for the purpose of making the rule clear to those of our readers who may not be familiar with trigonometrical and algebraic expressions.

It will, however, be recognised by some as the square of half the cord divided by the versed sine, plus the versed sine divided by 2 equal the radius.

For mensuration of brickwork the Author refers the reader to Mr. Hammond's "Practical Bricklaying," forming vol. 189 in this series.

## I N D E X.

- A**DDITIONS TO OLD WORK, 88.  
Angle of hip or valley tiles, to obtain, 92.  
Angle of skew, 47.  
    of strain, 26.  
Apertures, 23.  
Arc, to draw by cross sectional lines, 101.  
Arches, 43.  
    cutting of, 56.  
    principles of, 44.  
    whose courses have different bevels, 81.  
Axed work, 60.
- B**ASE, BOND OF, 24.  
    treatment of, 24.  
Battering jamb, 36.  
Bats, 27, 31.  
Bedding board, 62.  
Bends, 10.  
Berkshire builders, 15.  
Birdsmouthed key, 67.  
Blocking courses, 85.  
Blue lias, 8.  
Boaster, 61.  
Bond of brickwork, 17.  
    underrated, 18.  
    of footings and walls, 19.  
    Gwilt on, 19.  
    Smeaton on, 18.  
Boyd's flue-plates, 42.  
Bricks, 14.  
    characteristics of good, 17.  
    differences in sizes of, 36.  
    case hardening of, 59.  
    wetting of, 25.  
Brick groins, 55.
- Brickwork, 2.  
    characteristics of good, 37.  
Broken bond, 24.  
    cause of, 25.  
    in Flemish, 30.  
Brondesbury bridge, 52.  
Broseley tiles, 89.  
Building new work into old, 37.  
Bull's-eye, 61.  
Burning clay into ballast, 96.  
Burnt ballast, 8.  
Buttering joints, evil of, 31.
- C**AMBER ARCH, 60, 64.  
    invisible arch in, 104.  
    mould, 65.  
    to describe by mechanical means, 65.  
    to take off lengths and bevels of courses, 65.  
Carved work, 60.  
Catenary curve, 45.  
Cement-testing machine, 8.  
Centre for niche head, 77.  
Chalk lime, 12.  
Chimney bond, 31.  
Chimney stacks, 31.  
    walls of  $4\frac{1}{2}$  inches, 31.  
Closer or Closure, 20, 28.  
Colour in stopping, objection to, 95.  
Concrete, 2.  
    thickness of, 5.  
    specification of mixing, 6.  
Construction of arches, 52.  
Copperas, 95.  
Coing holes, 81.  
Counterbalance, 81.

- Coursing joints, 67.  
     mould, 49.  
 Cross joints, 22.
- D**ENNETT'S PATENT, 89.  
     Development of soffit of skew arch, 48.  
 Dipping, 60.  
 Dips in drains, 10.  
 Dip-trap, 12.  
 Dog's-tooth, 49.  
 Doors, positions of, 23.  
 Drains, laying of, 10.  
     fall of, 10.  
     cause of stoppage, 10.  
     ventilation of, 11.  
 Drain-pipes, sizes of, 11.  
 Drawing and cutting arches, 61.  
 Dutch bond, 34.  
     advantages claimed for, 35.
- E**ARTHENWARE TRAPS, 12.  
     Ellipse, to describe, 108.  
 Ellipse Gothic arch, 68.  
     to describe by cross sectional lines, 109.  
 Enamelled bricks, 16.  
 English garden wall bond, 32.  
 English bond in chimney stacks, 31.  
 Excavations, 2.  
 Extradados, 62.
- F**ACE MOULD, 61, 63.  
     Fareham bricks, 15, 58.  
 Fire bricks, 16.  
 Fireclay, 16.  
 Fireplace for register stove, 41.  
 Fireproof floors, 98.  
 Flat joint pointing, 94.  
 Flashing to chimney-stacks, 32.  
 Flat arch, to find joints of, 102.  
 Flemish, 18, 28.  
 Flemish garden wall bond, 33.  
 Flues, 38.  
     building of, 40.  
     down draught, 40.  
     disadvantage of too large sectional area, 39.
- Flues, sizes of, 41.  
 Flushing, 26.  
 Footings, 6, 19, 20.  
 Forcing-rods, 10.  
 Formation of centre for niche head, 77.  
 Foundations, 1.  
 Freestone lintels, cause of fracturing, 45.
- G**AUGE OF TILES, 91, 92.  
     Gauge-rod, 25.  
 Gauged work, 15, 56, 58, 60.  
 Gault bricks, 15.  
 Geometry, 99.  
 Gothic arches, 60, 66.  
     to draw arch bricks of, 110.  
     on circle arch, 73.  
     vaulting, 55, 56, 57.  
     window, 84.  
 Grizzles, 14.  
 Groined vaulting, 55.  
 Ground blue lias, 2.  
 Ground-damp, 2.  
 Grouting, 26, 37.
- H**EADING BOND, 26.  
     Herring-bone bond, 33.  
 Hip tiles, 90.
- I**NSPECTION HOLES, 10.
- J**AMB, 23.  
     Jointers, 94.
- K**ING CLOSURE, 23.  
     Kneeler, 84.
- L**ARRYING UP, 38.  
     Level or datum, 2.  
 Lime, 12.  
 Lines of force or thrust, 52.  
 Line of frontage, 3.  
 Line of radii, 52, 54.  
 Lines, to connect by means of a curve, 105.  
 Lintels, 45.

London clay, 5.  
 Long skew arches, treatment  
 of, 48.  
 Lump lias, 12.

**M**ADE-UP GROUND, 5.  
 Malms, 15, 58.  
 action of London smoke on,  
 59.

Man-hole, 11.  
 Mortar, 12, 25.  
 Moulded courses, 79.  
 Mullions, 70, 85.

**N**ICHE, 75.  
 hood, 77.  
 mould, 79.  
 length and bevel of courses  
 to, 78.

**O**LD ENGLISH BOND, 18.  
 Open soil-pipe, 11.  
 Operculum or channel-pipe, 10.  
 Oriel window, 81.  
 Ornamental arches, 80.  
 Ornamental brickwork, 75, 86.  
 Ornamental gable or pediment,  
 83.

**P**ARGETTING, 31.  
 Paving, 33.  
 Perpend, 36.  
 Picked stocks, 14.  
 Place bricks, 14.  
 Plain arches, 46.  
 Plan of skew arch, 47.  
 Plinth, 24.  
 Pointing, 36, 93.  
 Portland cement, 2, 6.  
 Portland cement concrete, 7.  
 Pressed bricks, 17.  
 Principle of ordinary skew arch,  
 51.  
 Projecting courses, 82.  
 Purpose-made brick, 54.

**Q**UEEN ANNE'S STYLE OF ARCHI-  
 TECTURE, 75.  
 revival of, 13.  
 Quoin, 4, 30.

**R**ADIUS-ROD, LENGTH OF, FOR  
 CAMBER, 101.  
 to obtain by formula, 101.  
 Raking moulding, 107.  
 Red brickwork, 13.  
 to clean down, 96.  
 Red building bricks, 15.  
 Relieving arches, 45.  
 Reveal, 23.  
 bond of, 24.  
 Reversing the bond, 31.  
 Right-angled junctions, 10.  
 Roman tile, 27.  
 Roofs of different pitch, 90.  
 Rosendale cement, 54.  
 Rubbers, 15, 59.

**S**AND, 7, 12.  
 Section-box, 79.  
 mould, 74.  
 Section of niche, 76.  
 Scheme, 69.  
 Scheme arch, 71.  
 "Scotch," 61.  
 Scriber, 61.  
 Semi-ellipse arch, 69, 103.  
 Semi and segmental arches, 63.  
 Semi-Gothic arch, 72.  
 Setting, 59, 60.  
 Setting out and cutting, 62.  
 Setting out building, 2.  
 Setting out the bond, 23.  
 Sewer gas, 11.  
 Sewers, 54.  
 Sharp bends in flues, evil of, 39.  
 Shippers, 15.  
 Ships, 14.  
 Site, 1.  
 Skew arch, 46, 49.  
 Skewback of camber, 104.  
 Smoky flues, 38.  
 Snapped headers, 29, 31.  
 Soakers, 32.  
 Soffit-mould of Gothic on circle,  
 74.  
 Stacks in  $4\frac{1}{2}$ -inch walls, 31.  
 Staffordshire blue bricks, 16, 49.  
 Stock bricks, 14.  
 Stockwork, 58.  
 Stone lime, 12, 60.

- Stone strings, 25.  
 Stopping in pointing, 94, 96.  
 String courses, 27.  
 Stuccoed buildings, 13.  
 Stourbridge fire bricks, 17.  
 Subsoil, 5.  
 Surface concrete, 2.
- T**AILING DOWN, 82.  
 Taking off bevels, 62.  
 Templates and strings, 27.  
 Testing cement, 9.  
 Teynham bricks, 15.  
 Thames ballast, 8, 96.  
 Thick and thin joints, 25.  
 Three-quarter stretcher, 22, 25, 28.  
 Tiled roof, advantage of, 88.  
 Tiling, 88.  
     characteristics of good, 88.  
 Tile fillet, 84.  
 Tiles, characteristics of good, 88.  
     improved method of hanging, 89.  
 Timber foundation, 54.  
 T. L. B. Rubbers, 58.
- To find the radius of any arc or arch, 110.  
 Tools for arch cutting, 61.  
 Toothings, 36.  
 Transverse joints, 20, 21.  
 Transversing the courses, 62.  
 Triangle, 100.  
 Tuck-pointing, 93.  
 Tumbling in buttresses, &c., 35.  
 Tympana of arches, 34, 85.
- V**ALLEY TILES, 92.  
     Valleys, 91.  
 Various bonds, 31.  
 Venetian arch, 70.  
 Voussoirs, 44, 61.
- W**ALL IN FLEMISH FACE AND ENGLISH BACK, 29.  
 Washed stocks, 14.  
 Water conduit, 53.  
 Weather-jointing, 94.  
 White Suffolks, 15, 58.  
 Windows, 23.  
 Wing gatherings, 38, 41.  
 Withes, 31, 32, 42.

THE END.





# Weale's Rudimentary Series.



LONDON, 1862.

THE PRIZE MEDAL

Was awarded to the Publishers of

"WEALE'S SERIES."



A NEW LIST OF

## WEALE'S SERIES

RUDIMENTARY SCIENTIFIC, EDUCATIONAL,  
AND CLASSICAL.

*Comprising nearly Three Hundred and Fifty distinct works in almost every department of Science, Art, and Education, recommended to the notice of Engineers, Architects, Builders, Artisans, and Students generally, as well as to those interested in Workmen's Libraries, Literary and Scientific Institutions, Colleges, Schools, Science Classes, &c., &c.*

“WEALE'S SERIES includes Text-Books on almost every branch of Science and Industry, comprising such subjects as Agriculture, Architecture and Building, Civil Engineering, Fine Arts, Mechanics and Mechanical Engineering, Physical and Chemical Science, and many miscellaneous Treatises. The whole are constantly undergoing revision, and new editions, brought up to the latest discoveries in scientific research, are constantly issued. The prices at which they are sold are as low as their excellence is assured.”—*American Literary Gazette.*

“Amongst the literature of technical education, WEALE'S SERIES has ever enjoyed a high reputation, and the additions being made by Messrs. CROSBY LOCKWOOD & Co. render the series even more complete, and bring the information upon the several subjects down to the present time.”—*Mining Journal.*

“It is impossible to do otherwise than bear testimony to the value of WEALE'S SERIES.”—*Engineer.*

“Everybody—even that outrageous nuisance 'Every Schoolboy'—knows the merits of 'WEALE'S RUDIMENTARY SERIES.' Any persons wishing to acquire knowledge cannot do better than look through Weale's Series and get all the books they require. The Series is indeed an inexhaustible mine of literary wealth.”—*The Metropolitan.*

“WEALE'S SERIES has become a standard as well as an unrivalled collection of treatises in all branches of art and science.”—*Public Opinion.*



PHILADELPHIA, 1876.

THE PRIZE MEDAL

Was awarded to the Publishers for

Books: Rudimentary, Scientific,

"WEALE'S SERIES," ETC.



CROSBY LOCKWOOD & CO.,

7, STATIONERS' HALL COURT, LUDGATE HILL, LONDON, E.C.

## WEALE'S RUDIMENTARY SCIENTIFIC SERIES.



\*\* The volumes of this Series are freely Illustrated with Woodcuts, or otherwise, where requisite. Throughout the following List it must be understood that the books are bound in limp cloth, unless otherwise stated; *but the volumes marked with a ‡ may also be had strongly bound in cloth boards for 6d. extra.*

*N.B.—In ordering from this List it is recommended, as a means of facilitating business and obviating error, to quote the numbers affixed to the volumes, as well as the titles and prices.*

## CIVIL ENGINEERING, SURVEYING, ETC.

- No.
31. *WELLS AND WELL-SINKING.* By JOHN GEO. SWINDELL, A.R.I.B.A., and G. R. BURNELL, C.E. Revised Edition. With a New Appendix on the Qualities of Water. Illustrated. 2s.
35. *THE BLASTING AND QUARRYING OF STONE,* for Building and other Purposes. With Remarks on the Blowing up of Bridges. By Gen. Sir JOHN BURGOYNE, Bart., K.C.B. Illustrated. 1s. 6d.
44. *FOUNDATIONS AND CONCRETE WORKS,* containing a Synopsis of the principal cases of Foundation Works, &c., Practical Remarks on Footings, Planking, Sand, Concrete, Béton, Pile-driving, Caissons, and Cofferdams, &c. By E. DOBSON, M.R.I.B.A. Fifth Edition. 1s. 6d.
60. *LAND AND ENGINEERING SURVEYING,* a Treatise on; with all the Modern Improvements. By T. BAKER, C.E. New Edition, revised by EDWARD NUGENT, C.E. Illustrated with Plates and Diagrams. 2s. ‡
- 80\*. *EMBANKING LANDS FROM THE SEA.* With examples and Particulars of actual Embankments, &c. By J. WIGGINS, F.G.S. 2s.
81. *WATER WORKS,* for the Supply of Cities and Towns. With a Description of the Principal Geological Formations of England as influencing Supplies of Water; and Details of Engines and Pumping Machinery for raising Water. By SAMUEL HUGHES, F.G.S., C.E. New Edition. 4s. ‡
117. *SUBTERRANEAN SURVEYING,* an Elementary and Practical Treatise on. By THOMAS FENWICK. Also the Method of Conducting Subterranean Surveys without the Use of the Magnetic Needle, and other Modern Improvements. By THOMAS BAKER, C.E. Illustrated. 2s. 6d. ‡
118. *CIVIL ENGINEERING IN NORTH AMERICA,* a Sketch of. By DAVID STEVENSON, F.R.S.E., &c. Plates and Diagrams. 3s.
167. *IRON BRIDGES, GIRDERS, ROOFS, AND OTHER WORKS.* By FRANCIS CAMPIN, C.E. 2s. 6d. ‡
197. *ROADS AND STREETS (THE CONSTRUCTION OF),* in two Parts: I. THE ART OF CONSTRUCTING COMMON ROADS, by HENRY LAW, C.E., revised by D. K. CLARK, C.E.; II. RECENT PRACTICE, including pavements of Stone, Wood, and Asphalte, by D. K. CLARK. 4s. 6d. ‡
203. *SANITARY WORK IN THE SMALLER TOWNS AND IN VILLAGES.* Comprising:—1. Some of the more Common Forms of Nuisance and their Remedies; 2. Drainage; 3. Water Supply. By CHARLES SLAGG, Assoc. M. Inst. C.E. Second Edition, revised and enlarged. 3s. ‡
212. *THE CONSTRUCTION OF GAS-WORKS,* and the Manufacture and Distribution of Coal Gas. Originally written by SAMUEL HUGHES, C.E. Sixth Edition, re-written and much enlarged by WILLIAM RICHARDS, C.E. With 72 Illustrations. 4s. 6d. ‡
213. *PIONEER ENGINEERING.* A Treatise on the Engineering Operations connected with the Settlement of Waste Lands in New Countries. By EDWARD DOBSON, Assoc. Inst. C.E. 4s. 6d. ‡

 The ‡ indicates that these vols. may be had strongly bound at 6d. extra.

LONDON: CROSBY LOCKWOOD AND CO.,

**Civil Engineering, Surveying, etc., continued.**

216. **MATERIALS AND CONSTRUCTION**; A Theoretical and Practical Treatise on the Strains, Designing, and Erection of Works of Construction. By FRANCIS CAMPIN, C.E. Second Edition, revised. 3s.‡
219. **CIVIL ENGINEERING**. By HENRY LAW, M.Inst. C.E. Including HYDRAULIC ENGINEERING by GEO. R. BURNELL, M.Inst. C.E. Seventh Edition, revised, with large additions by D. KINNEAR CLARK, M.Inst. C.E. 6s. 6d., Cloth boards, 7s. 6d.

**MECHANICAL ENGINEERING, ETC.**

33. **CRANES**, the Construction of, and other Machinery for Raising Heavy Bodies. By JOSEPH GLYNN, F.R.S. Illustrated. 1s. 6d.
34. **THE STEAM ENGINE**. By Dr. LARDNER. Illustrated. 1s. 6d.
59. **STEAM BOILERS**: their Construction and Management. By R. ARMSTRONG, C.E. Illustrated. 1s. 6d.
82. **THE POWER OF WATER**, as applied to drive Flour Mills, and to give motion to Turbines, &c. By JOSEPH GLYNN, F.R.S. 2s.‡
98. **PRACTICAL MECHANISM**, the Elements of; and Machine Tools. By T. BAKER, C.E. With Additions by J. NASMYTH, C.E. 2s. 6d.‡
139. **THE STEAM ENGINE**, a Treatise on the Mathematical Theory of, with Rules and Examples for Practical Men. By T. BAKER, C.E. 1s. 6d.
164. **MODERN WORKSHOP PRACTICE**, as applied to Marine, Land, and Locomotive Engines, Floating Docks, Dredging Machines, Bridges, Cranes, Ship-building, &c., &c. By J. G. WINTON. Illustrated. 3s.‡
165. **IRON AND HEAT**, exhibiting the Principles concerned in the Construction of Iron Beams, Pillars, and Bridge Girders, and the Action of Heat in the Smelting Furnace. By J. ARMOUR, C.E. 2s. 6d.‡
166. **POWER IN MOTION**: Horse-Power, Toothed-Wheel Gearing, Long and Short Driving Bands, and Angular Forces. By J. ARMOUR, 2s. 6d.‡
171. **THE WORKMAN'S MANUAL OF ENGINEERING DRAWING**. By J. MAXTON. 5th Edn. With 7 Plates and 350 Cuts. 3s. 6d.‡
190. **STEAM AND THE STEAM ENGINE**, Stationary and Portable. By JOHN SEWELL and D. K. CLARK, M.I.C.E. 3s. 6d.‡
200. **FUEL**, its Combustion and Economy. By C. W. WILLIAMS, With Recent Practice in the Combustion and Economy of Fuel—Coal, Coke, Wood, Peat, Petroleum, &c.—by D. K. CLARK, M.I.C.E. 3s. 6d.‡
202. **LOCOMOTIVE ENGINES**. By G. D. DEMPSEY, C.E.; with large additions by D. KINNEAR CLARK, M.I.C.E. 3s.‡
211. **THE BOILERMAKER'S ASSISTANT** in Drawing, Templating, and Calculating Boiler and Tank Work. By JOHN COURTNEY, Practical Boiler Maker. Edited by D. K. CLARK, C.E. 100 Illustrations. 2s.
217. **SEWING MACHINERY**: Its Construction, History, &c., with full Technical Directions for Adjusting, &c. By J. W. URQUHART, C.E. 2s.‡
223. **MECHANICAL ENGINEERING**. Comprising Metallurgy, Moulding, Casting, Forging, Tools, Workshop Machinery, Manufacture of the Steam Engine, &c. By FRANCIS CAMPIN, C.E. 2s. 6d.‡
236. **DETAILS OF MACHINERY**. Comprising Instructions for the Execution of various Works in Iron in the Fitting-Shop, Foundry, and Boiler-Yard. By FRANCIS CAMPIN, C.E. 3s.‡
237. **THE SMITHY AND FORGE**; including the Farrier's Art and Coachsmithing. By W. J. E. CRANE. Illustrated. 2s. 6d.‡
238. **THE SHEET-METAL WORKER'S GUIDE**; a Practical Handbook for Tinsmiths, Coppersmiths, Zincworkers, &c. With 94 Diagrams and Working Patterns. By W. J. E. CRANE. 1s. 6d.
251. **STEAM AND MACHINERY MANAGEMENT**: a Guide to the Arrangement and Economical Management of Machinery, with Hints on Construction and Selection. By M. POWIS BALE, M.Inst.M.E., A.M.Inst.C.E. 2s. 6d.‡

[Just published.]

 The ‡ indicates that these vols. may be had strongly bound at 6d. extra.

7, STATIONERS' HALL COURT, LUDGATE HILL, E.C.

### MINING, METALLURGY, ETC.

4. *MINERALOGY*, Rudiments of; a concise View of the Properties of Minerals. By A. RAMSAY, Jun. Woodcuts and Steel Plates. 3s.‡
117. *SUBTERRANEAN SURVEYING*, Elementary and Practical Treatise on, with and without the Magnetic Needle. By THOMAS FENWICK, Surveyor of Mines, and THOMAS BAKER, C.E. Illustrated. 2s. 6d.‡
133. *METALLURGY OF COPPER*; an Introduction to the Methods of Seeking, Mining, and Assaying Copper, and Manufacturing its Alloys. By ROBERT H. LAMBORN. Ph.D. Woodcuts. 2s. 6d.‡
135. *ELECTRO-METALLURGY*; Practically Treated. By ALEXANDER WATT, F.R.S.S.A. Eighth Edition, revised, with additional Matter and Illustrations, including the most recent Processes. 3s.‡
172. *MINING TOOLS*, Manual of. For the Use of Mine Managers, Agents, Students, &c. By WILLIAM MORGANS. 2s. 6d.‡
- 172\*. *MINING TOOLS, ATLAS* of Engravings to Illustrate the above, containing 235 Illustrations, drawn to Scale. 4to. 4s. 6d.; cloth boards, 6s.
176. *METALLURGY OF IRON*. Containing History of Iron Manufacture. Methods of Assay, and Analyses of Iron Ores, Processes of Manufacture of Iron and Steel, &c. By H. BAUERMAN, F.G.S. Fifth Edition, revised and enlarged. 5s.‡
180. *COAL AND COAL MINING*. By WARINGTON W. SMYTH, M.A., F.R.S. Fifth Edition, revised. With numerous Illustrations. 3s. 6d.‡
195. *THE MINERAL SURVEYOR AND VALUER'S COMPLETE GUIDE*, with new Traverse Tables, and Descriptions of Improved Instruments; also the Correct Principles of Laying out and Valuing Mineral Properties. By WILLIAM LINTERN, Mining and Civil Engineer. 3s. 6d.‡
214. *SLATE AND SLATE QUARRYING*, Scientific, Practical, and Commercial. By D. C. DAVIES, F.G.S., Mining Engineer, &c. 3s.‡
220. *MAGNETIC SURVEYING, AND ANGULAR SURVEYING*, with Records of the Peculiarities of Needle Disturbances. Compiled from the Results of carefully made Experiments. By W. LINTERN. 2s.

### ARCHITECTURE, BUILDING, ETC.

16. *ARCHITECTURE—ORDERS*—The Orders and their Æsthetic Principles. By W. H. LEEDS. Illustrated. 1s. 6d.
17. *ARCHITECTURE—STYLES*—The History and Description of the Styles of Architecture of Various Countries, from the Earliest to the Present Period. By T. TALBOT BURY, F.R.I.B.A., &c. Illustrated. 2s.  
\*\* *ORDERS AND STYLES OF ARCHITECTURE, in One Vol., 3s. 6d.*
18. *ARCHITECTURE—DESIGN*—The Principles of Design in Architecture, as deducible from Nature and exemplified in the Works of the Greek and Gothic Architects. By E. L. GARBETT, Architect. Illustrated. 2s. 6d.  
\*\* *The three preceding Works, in One handsome Vol., half bound, entitled "MODERN ARCHITECTURE," price 6s.*
22. *THE ART OF BUILDING*, Rudiments of. General Principles of Construction, Materials used in Building, Strength and Use of Materials, Working Drawings, Specifications, and Estimates. By E. DOBSON, 2s.‡
25. *MASONRY AND STONECUTTING*; in which the Principles of Masonic Projection and their application to the Construction of Curved Wing-Walls, Domes, Oblique Bridges, and Roman and Gothic Vaulting, are explained. By EDWARD DOBSON, M.R.I.B.A., &c. 2s. 6d.‡
42. *COTTAGE BUILDING*. By C. BRUCE ALLEN, Architect. Ninth Edition, revised and enlarged. Numerous Illustrations. 1s. 6d.
45. *LIMES, CEMENTS, MORTARS, CONCRETES, MASTICS, PLASTERING*, &c. By G. R. BURNELL, C.E. Twelfth Edition. 1s. 6d.

 *The ‡ indicates that these vols. may be had strongly bound at 6d. extra.*

LONDON: CROSBY LOCKWOOD AND CO.,

Architecture, Building, etc., *continued.*

57. *WARMING AND VENTILATION.* An Exposition of the General Principles as applied to Domestic and Public Buildings, Mines, Lighthouses, Ships, &c. By C. TOMLINSON, F.R.S., &c. Illustrated. 3s.
111. *ARCHES, PIERS, BUTTRESSES, &c.:* Experimental Essays on the Principles of Construction. By W. BLAND. Illustrated. 1s. 6d.
116. *THE ACOUSTICS OF PUBLIC BUILDINGS;* or, The Principles of the Science of Sound applied to the purposes of the Architect and Builder. By T. ROGER SMITH, M.R.I.B.A., Architect. Illustrated. 1s. 6d.
127. *ARCHITECTURAL MODELLING IN PAPER,* the Art of. By T. A. RICHARDSON, Architect. Illustrated. 1s. 6d.
128. *VITRUVIUS—THE ARCHITECTURE OF MARCUS VITRUVIUS POLLO.* In Ten Books. Translated from the Latin by JOSEPH GWILT, F.S.A., F.R.A.S. With 23 Plates. 5s.
130. *GRECIAN ARCHITECTURE,* An Inquiry into the Principles of Beauty in; with an Historical View of the Rise and Progress of the Art in Greece. By the EARL OF ABERDEEN. 1s.
- \*• *The two preceding Works in One handsome Vol., half bound, entitled "ANCIENT ARCHITECTURE," price 6s.*
132. *THE ERECTION OF DWELLING-HOUSES.* Illustrated by a Perspective View, Plans, Elevations, and Sections of a pair of Semi-detached Villas, with the Specification, Quantities, and Estimates, &c. By S. H. BROOKS. New Edition, with Plates. 2s. 6d.‡
156. *QUANTITIES AND MEASUREMENTS,* How to Calculate and Take them in Bricklayers', Masons', Plasterers', Plumbers', Painters', Paper-hangers', Gilders', Smiths', Carpenters', and Joiners' Work. By A. C. BEATON, Architect and Surveyor. New and Enlarged Edition. Illus. 1s. 6d.
175. *LOCKWOOD & CO.'S BUILDER'S AND CONTRACTOR'S PRICE BOOK,* containing the latest Prices of all kinds of Builders' Materials and Labour, and of all Trades connected with Building, &c., &c. Edited by F. T. W. MILLER, Architect. Published annually. 3s. 6d.; half bound, 4s.
182. *CARPENTRY AND JOINERY—THE ELEMENTARY PRINCIPLES OF CARPENTRY.* Chiefly composed from the Standard Work of THOMAS TREBGOLD, C.E. With Additions from the Works of the most Recent Authorities, and a TREATISE ON JOINERY by E. WYNDHAM TARN, M.A. Numerous Illustrations. 3s. 6d.‡
- 182\*. *CARPENTRY AND JOINERY. ATLAS* of 35 Plates to accompany the above. With Descriptive Letterpress. 4to. 6s.; cloth, 7s. 6d.
185. *THE COMPLETE MEASURER;* the Measurement of Boards, Glass, &c.; Unequal-sided, Square-sided, Octagonal-sided, Round Timber and Stone, and Standing Timber, &c. By RICHARD HORTON. Fourth Edition. 4s.; strongly bound in leather, 5s.
187. *HINTS TO YOUNG ARCHITECTS.* By G. WIGHTWICK. New Edition. By G. H. GUILLAUME. Illustrated. 3s. 6d.‡
188. *HOUSE PAINTING, GRAINING, MARBLING, AND SIGN WRITING:* containing full information on the Processes of House-Painting, the Practice of Sign-Writing, the Principles of Decorative Art, a Course of Elementary Drawing for House-Painters, Writers, &c., &c. With 9 Coloured Plates, and nearly 150 Wood Engravings. By ELLIS A. DAVIDSON. Fourth Edition. 5s. cloth limp; 6s. cloth boards.
189. *THE RUDIMENTS OF PRACTICAL BRICKLAYING.* In Six Sections: General Principles; Arch Drawing, Cutting, and Setting; Pointing; Paving, Tiling, Materials; Slating and Plastering; Practical Geometry, Mensuration, &c. By ADAM HAMMOND. Illustrated. 1s. 6d.
191. *PLUMBING.* A Text-Book to the Practice of the Art or Craft of the Plumber. With Chapters upon House Drainage. Fourth Edition. With 330 Illustrations. By W. P. BUCHAN. 3s. 6d.‡

---

 *The ‡ indicates that these vols. may be had strongly bound at 6d. extra.*

7, STATIONERS' HALL COURT, LUDGATE HILL, E.C.

**Architecture, Building, etc., continued.**

192. *THE TIMBER IMPORTER'S, TIMBER MERCHANT'S, and BUILDER'S STANDARD GUIDE.* By RICHARD E. GRANDY. Second Edition, Revised. 3s.‡
206. *A BOOK ON BUILDING, Civil and Ecclesiastical,* including CHURCH RESTORATION. With the Theory of Domes and the Great Pyramid, &c. By SIR EDMUND BECKETT, Bart., LL.D., Q.C., F.R.A.S. 4s. 6d.‡
226. *THE JOINTS MADE AND USED BY BUILDERS* in the Construction of various kinds of Engineering and Architectural Works. By WYVILL J. CHRISTY, Architect. With upwards of 160 Engravings on Wood. 3s.‡
228. *THE CONSTRUCTION OF ROOFS OF WOOD AND IRON* By E. WYNDHAM TARN, M.A., Architect. Second Edition, revised. 1s. 6d.
229. *ELEMENTARY DECORATION:* as applied to the Interior and Exterior Decoration of Dwelling-Houses, &c. By JAMES W. FACEY, Jun. Illustrated with Sixty-eight explanatory Engravings. 2s.
230. *HANDRAILING (A Practical Treatise on).* Showing New and Simple Methods for finding the Pitch of the Plank, Drawing the Moulds, Bevelling, Jointing-up, and Squaring the Wreath. By GEORGE COLLINGS. Illustrated with Plates and Diagrams. 1s. 6d.
247. *BUILDING ESTATES:* a Rudimentary Treatise on the Development, Sale, Purchase, and General Management of Building Land, including the Formation of Streets and Sewers, and the Requirements of Sanitary Authorities. By FOWLER MAITLAND, Surveyor. Illustrated. 2s.
248. *PORTLAND CEMENT FOR USERS.* By HENRY FAIJA, Assoc. M. Inst. C.E. Second Edition, corrected. Illustrated. 2s.
252. *BRICKWORK:* a Practical Treatise, embodying the General and Higher Principles of Bricklaying, Cutting and Setting, &c. By F. WALKER. *[In the Press.]*

**SHIPBUILDING, NAVIGATION, MARINE ENGINEERING, ETC.**

51. *NAVAL ARCHITECTURE,* the Rudiments of; or an Exposition of the Elementary Principles of the Science, and their Practical Application to Naval Construction. Compiled for the Use of Beginners. By JAMES PEAKE. Fifth Edition, with Plates and Diagrams. 3s. 6d.‡
- 53\*. *SHIPS FOR OCEAN AND RIVER SERVICE,* Elementary and Practical Principles of the Construction of. By H. A. SOMMERFELDT, Surveyor of the Royal Norwegian Navy. With an Appendix. 1s. 6d.
- 53\*\*. *AN ATLAS OF ENGRAVINGS* to Illustrate the above. Twelve large folding plates. Royal 4to, cloth. 7s. 6d.
54. *MASTING, MAST-MAKING, AND RIGGING OF SHIPS,* Rudimentary Treatise on. Also Tables of Spars, Rigging, Blocks; Chain, Wire, and Hemp Ropes, &c., relative to every class of vessels. By ROBERT KIPPING, N.A. Fifteenth Edition. Illustrated. 2s.‡
- 54\*. *IRON SHIP-BUILDING.* With Practical Examples and Details for the Use of Ship Owners and Ship Builders. By JOHN GRANTHAM, Consulting Engineer and Naval Architect. 5th Edition, with Additions. 4s.
- 54\*\*. *AN ATLAS OF FORTY PLATES* to Illustrate the above. Fifth Edition. 4to, boards. 38s.
55. *THE SAILOR'S SEA BOOK:* a Rudimentary Treatise on Navigation. Part I. How to Keep the Log and Work it off. Part II. On Finding the Latitude and Longitude. By JAMES GREENWOOD, B.A. To which are added, the Deviation and Error of the Compass; Great Circle Sailing; the International (Commercial) Code of Signals; the Rule of the Road at Sea; Rocket and Mortar Apparatus for Saving Life; the Law of Storms; and a Brief Dictionary of Sea Terms. With Coloured Plates of Flags, &c. New, and enlarged edition. By W. H. ROSSER. 2s. 6d.‡

 The ‡ indicates that these vols. may be had strongly bound at 6d. extra.

Shipbuilding, Navigation, Marine Engineering, etc., *cont.*

80. *MARINE ENGINES, AND STEAM VESSELS.* By ROBERT MURRAY, C.E. Eighth Edition. *[In preparation.]*
- 83bis. *THE FORMS OF SHIPS AND BOATS:* Hints, Experimentally Derived, on some of the Principles regulating Ship-building. By W. BLAND. Seventh Edition, revised, with numerous Illustrations and Models. 1s. 6d.
99. *NAVIGATION AND NAUTICAL ASTRONOMY,* in Theory and Practice. By Prof. J. R. YOUNG. New Edition, including the requisite Elements from the Nautical Almanac for working the Problems. 2s. 6d.
106. *SHIPS' ANCHORS,* a Treatise on. By G. COTSELL, N.A. 1s. 6d.
149. *SAILS AND SAIL-MAKING,* an Elementary Treatise on. With Draughting, and the Centre of Effort of the Sails. Also, Weights and Sizes of Ropes; Mastng, Rigging, and Sails of Steam Vessels, &c., &c. Eleventh Edition, enlarged, with an Appendix. By ROBERT KIPPING, N.A., Sailmaker, Quayside, Newcastle. Illustrated. 2s. 6d. †
155. *THE ENGINEER'S GUIDE TO THE ROYAL AND MERCANTILE NAVIES.* By a PRACTICAL ENGINEER. Revised by D. F. M'CARTHY, late of the Ordnance Survey Office, Southampton. 3s.
- 55 & 204. *PRACTICAL NAVIGATION.* Consisting of The Sailor's Sea-Book. By JAMES GREENWOOD and W. H. ROSSER. Together with the requisite Mathematical and Nautical Tables for the Working of the Problems. By HENRY LAW, C.E., and J. R. YOUNG, formerly Professor of Mathematics in Belfast College. Illustrated with numerous Wood Engravings and Coloured Plates. 7s. Strongly half-bound in leather.

### AGRICULTURE, GARDENING, ETC.

- 61\*. *READY RECKONER FOR THE ADMEASUREMENT OF LAND,* including Tables showing the price of work from 2s. 6d. to £1 per acre, and other useful Tables. By ABRAHAM ARMAN. Second Edition, corrected and extended by C. NORRIS, Surveyor, &c. 2s.
131. *MILLER'S, MERCHANT'S, AND FARMER'S READY RECKONER.* With approximate values of Millstones, Millwork, &c. 1s.
140. *SOILS, MANURES, AND CROPS.* (Vol. 1. OUTLINES OF MODERN FARMING.) By R. SCOTT BURN. Woodcuts. 2s.
141. *FARMING & FARMING ECONOMY,* Notes, Historical and Practical, on. (Vol. 2. OUTLINES OF MODERN FARMING.) By R. SCOTT BURN. 3s.
142. *STOCK; CATTLE, SHEEP, AND HORSES.* (Vol. 3. OUTLINES OF MODERN FARMING.) By R. SCOTT BURN. Woodcuts. 2s. 6d.
145. *DAIRY, PIGS, AND POULTRY,* Management of the. By R. SCOTT BURN. With Notes on the Diseases of Stock. (Vol. 4. OUTLINES OF MODERN FARMING.) Woodcuts. 2s.
146. *UTILIZATION OF SEWAGE, IRRIGATION, AND RECLAMATION OF WASTE LAND.* (Vol. 5. OUTLINES OF MODERN FARMING.) By R. SCOTT BURN. Woodcuts. 2s. 6d.
- \* \* Nos. 140-1-2-5-6, in One Vol., handsomely half-bound, entitled "OUTLINES OF MODERN FARMING." By ROBERT SCOTT BURN. Price 12s.
177. *FRUIT TREES,* The Scientific and Profitable Culture of. From the French of DU BREUIL. Revised by GEO. GLENNY. 187 Woodcuts. 3s. 6d. †
198. *SHEEP; THE HISTORY, STRUCTURE, ECONOMY, AND DISEASES OF.* By W. C. SPOONER, M.R.V.C., &c. Fourth Edition, enlarged, including Specimens of New and Improved Breeds. 3s. 6d. †
201. *KITCHEN GARDENING MADE EASY.* Showing how to prepare and lay out the ground, the best means of cultivating every known Vegetable and Herb, &c. By GEORGE M. F. GLENNY. 1s. 6d. †

 The † indicates that these vols. may be had strongly bound at 6d. extra.

7, STATIONERS' HALL COURT, LUDGATE HILL, E.C.



Agriculture, Gardening, etc., *continued.*

207. *OUTLINES OF FARM MANAGEMENT, and the Organization of Farm Labour*: Treating of the General Work of the Farm; Field and Live Stock; Contract Work; Labour, &c. By R. SCOTT BURN. 2s. 6d.‡
208. *OUTLINES OF LANDED ESTATES MANAGEMENT*: Treating of the Varieties of Lands, Methods of Farming, Farm Buildings, Irrigation, Drainage, &c. By R. SCOTT BURN. 2s. 6d.‡
- \*• Nos. 207 & 208 in *One Vol., handsomely half-bound, entitled "OUTLINES OF LANDED ESTATES AND FARM MANAGEMENT."* By R. SCOTT BURN. *Price 6s.*
209. *THE TREE PLANTER AND PLANT PROPAGATOR*. A Practical Manual on the Propagation of Forest Trees, Fruit Trees, Flowering Shrubs, Flowering Plants, &c. By SAMUEL WOOD. 2s.‡
210. *THE TREE PRUNER*. A Practical Manual on the Pruning of Fruit Trees, including also their Training and Renovation; also the Pruning of Shrubs, Climbers, and Flowering Plants. By SAMUEL WOOD. 2s.‡
- \*• Nos. 209 & 210 in *One Vol., handsomely half-bound, entitled "THE TREE PLANTER, PROPAGATOR, AND PRUNER."* By SAMUEL WOOD. *Price 5s.*
218. *THE HAY AND STRAW MEASURER*: Being New Tables for the Use of Auctioneers, Valuers, Farmers, Hay and Straw Dealers, &c. Fourth Edition. By JOHN STEELE. 2s.
222. *SUBURBAN FARMING*. The Laying-out and Cultivation of Farms, adapted to the Produce of Milk, Butter, and Cheese, Eggs, Poultry, and Pigs. By Prof. JOHN DONALDSON and R. SCOTT BURN. 3s. 6d.‡
231. *THE ART OF GRAFTING AND BUDDING*. By CHARLES BALLET. With Illustrations. 2s. 6d.‡
232. *COTTAGE GARDENING*; or, Flowers, Fruits, and Vegetables for Small Gardens. By E. HOBDAY. 1s. 6d.
233. *GARDEN RECEIPTS*. Edited by CHARLES W. QUIN. 1s. 6d.
234. *THE KITCHEN AND MARKET GARDEN*. Compiled by C. W. SHAW, Editor of "Gardening Illustrated." 3s.‡
239. *DRAINING AND EMBANKING*. A Practical Treatise, embodying the most recent experience in the Application of Improved Methods. By JOHN SCOTT, late Professor of Agriculture and Rural Economy at the Royal Agricultural College, Cirencester. With 68 Illustrations. 1s. 6d.
240. *IRRIGATION AND WATER SUPPLY*. A Treatise on Water Meadows, Sewage Irrigation, Warping, &c.; on the Construction of Wells, Ponds, and Reservoirs; and on Raising Water by Machinery for Agricultural and Domestic Purposes. By Prof. JOHN SCOTT. With 34 Illus. 1s. 6d.
241. *FARM ROADS, FENCES, AND GATES*. A Practical Treatise on the Roads, Tramways, and Waterways of the Farm; the Principles of Enclosures; and the different kinds of Fences, Gates, and Stiles. By Professor JOHN SCOTT. With 75 Illustrations. 1s. 6d.
242. *FARM BUILDINGS*. A Practical Treatise on the Buildings necessary for various kinds of Farms, their Arrangement and Construction, including Plans and Estimates. By Prof. JOHN SCOTT. With 105 Illus. 2s.
243. *BARN IMPLEMENTS AND MACHINES*. A Practical Treatise on the Application of Power to the Operations of Agriculture; and on various Machines used in the Threshing-barn, in the Stock-yard, and in the Dairy, &c. By Prof. J. SCOTT. With 123 Illustrations. 2s. [*Just published.*]
244. *FIELD IMPLEMENTS AND MACHINES*. By Professor JOHN SCOTT. Illustrated. [*In the press.*]
245. *AGRICULTURAL SURVEYING, LEVELLING, &c.* By Prof. JOHN SCOTT. Illustrated. [*In the press.*]
250. *MEAT PRODUCTION*. A Manual for Producers, Distributors, &c. By JOHN EWART. 2s. 6d.‡

 The ‡ indicates that these vols. may be had strongly bound at 6d. extra.

LONDON: CROSBY LOCKWOOD AND CO.,

## MATHEMATICS, ARITHMETIC, ETC.

32. *MATHEMATICAL INSTRUMENTS*, a Treatise on; in which their Construction and the Methods of Testing, Adjusting, and Using them are concisely Explained. By J. F. HEATHER, M.A., of the Royal Military Academy, Woolwich. Original Edition, in 1 vol., Illustrated. 1s. 6d.
- \*.\* *In ordering the above, be careful to say, "Original Edition" (No. 32), to distinguish it from the Enlarged Edition in 3 vols. (Nos. 168-9-70.)*
76. *DESCRIPTIVE GEOMETRY*, an Elementary Treatise on; with a Theory of Shadows and of Perspective, extracted from the French of G. MONGE. To which is added, a description of the Principles and Practice of Isometrical Projection. By J. F. HEATHER, M.A. With 14 Plates. 2s.
178. *PRACTICAL PLANE GEOMETRY*: giving the Simplest Modes of Constructing Figures contained in one Plane and Geometrical Construction of the Ground. By J. F. HEATHER, M.A. With 215 Woodcuts. 2s.
83. *COMMERCIAL BOOK-KEEPING*. With Commercial Phrases and Forms in English, French, Italian, and German. By JAMES HADDON, M.A., Arithmetical Master of King's College School, London. 1s. 6d.
84. *ARITHMETIC*, a Rudimentary Treatise on: with full Explanations of its Theoretical Principles, and numerous Examples for Practice. By Professor J. R. YOUNG. Tenth Edition, corrected. 1s. 6d.
- 84\*. A KEY to the above, containing Solutions in full to the Exercises, together with Comments, Explanations, and Improved Processes, for the Use of Teachers and Unassisted Learners. By J. R. YOUNG. 1s. 6d.
85. *EQUATIONAL ARITHMETIC*, applied to Questions of Interest,
- 85\*. Annuities, Life Assurance, and General Commerce; with various Tables by which all Calculations may be greatly facilitated. By W. HIPSLBY. 2s.
86. *ALGEBRA*, the Elements of. By JAMES HADDON, M.A. With Appendix, containing miscellaneous Investigations, and a Collection of Problems in various parts of Algebra. 2s.
- 86\*. A KEY AND COMPANION to the above Book, forming an extensive repository of Solved Examples and Problems in Illustration of the various Expedients necessary in Algebraical Operations. By J. R. YOUNG. 1s. 6d.
88. *EUCLID, THE ELEMENTS OF*: with many additional Propositions
89. and Explanatory Notes: to which is prefixed, an Introductory Essay on Logic. By HENRY LAW, C.E. 2s. 6d.†
- \*.\* *Sold also separately, viz. :—*
88. *EUCLID, The First Three Books*. By HENRY LAW, C.E. 1s. 6d.
89. *EUCLID, Books 4, 5, 6, 11, 12*. By HENRY LAW, C.E. 1s. 6d.
90. *ANALYTICAL GEOMETRY AND CONIC SECTIONS*, By JAMES HANN. A New Edition, by Professor J. R. YOUNG. 2s.†
91. *PLANE TRIGONOMETRY*, the Elements of. By JAMES HANN, formerly Mathematical Master of King's College, London. 1s. 6d.
92. *SPHERICAL TRIGONOMETRY*, the Elements of. By JAMES HANN. Revised by CHARLES H. DOWLING, C.E. 1s.
- \*.\* *Or with "The Elements of Plane Trigonometry," in One Volume, 2s. 6d.*
93. *MENSURATION AND MEASURING*. With the Mensuration and Levelling of Land for the Purposes of Modern Engineering. By T. BAKER, C.E. New Edition by E. NUGENT, C.E. Illustrated. 1s. 6d.
101. *DIFFERENTIAL CALCULUS*, Elements of the. By W. S. B. WOOLHOUSE, F.R.A.S., &c. 1s. 6d.
102. *INTEGRAL CALCULUS*, Rudimentary Treatise on the. By HOMERSHAM COX, B.A. Illustrated. 1s.
105. *MNEMONICAL LESSONS*. — GEOMETRY, ALGEBRA, AND TRIGONOMETRY, in Easy Mnemonical Lessons. By the Rev. THOMAS PENYNGTON KIRKMAN, M.A. 1s. 6d.
136. *ARITHMETIC*, Rudimentary, for the Use of Schools and Self-Instruction. By JAMES HADDON, M.A. Revised by A. ARMAN. 1s. 6d.
137. A KEY TO HADDON'S RUDIMENTARY ARITHMETIC. By A. ARMAN. 1s. 6d.

† The † indicates that these vols. may be had strongly bound at 6d. extra.

**Mathematics, Geometry, etc., continued.**

168. **DRAWING AND MEASURING INSTRUMENTS.** Including—I. Instruments employed in Geometrical and Mechanical Drawing, and in the Construction, Copying, and Measurement of Maps and Plans. II. Instruments used for the purposes of Accurate Measurement, and for Arithmetical Computations. By J. F. HEATHER, M.A. Illustrated. 1s. 6d.
169. **OPTICAL INSTRUMENTS.** Including (more especially) Telescopes, Microscopes, and Apparatus for producing copies of Maps and Plans by Photography. By J. F. HEATHER, M.A. Illustrated. 1s. 6d.
170. **SURVEYING AND ASTRONOMICAL INSTRUMENTS.** Including—I. Instruments Used for Determining the Geometrical Features of a portion of Ground. II. Instruments Employed in Astronomical Observations. By J. F. HEATHER, M.A. Illustrated. 1s. 6d.
- \*\* *The above three volumes form an enlargement of the Author's original work, "Mathematical Instruments." (See No. 32 in the Series.)*
168. } **MATHEMATICAL INSTRUMENTS.** By J. F. HEATHER,  
169. } M.A. Enlarged Edition, for the most part entirely re-written. The 3 Parts as  
170. } above, in One thick Volume. With numerous Illustrations. 4s. 6d. ‡
158. **THE SLIDE RULE, AND HOW TO USE IT;** containing full, easy, and simple Instructions to perform all Business Calculations with unexampled rapidity and accuracy. By CHARLES HOARE, C.E. With a Slide Rule in tuck of cover. 2s. 6d. ‡
196. **THEORY OF COMPOUND INTEREST AND ANNUITIES;** with Tables of Logarithms for the more Difficult Computations of Interest, Discount, Annuities, &c. By FÉDOR THOMAN. 4s. ‡
199. **INTUITIVE CALCULATIONS;** or, Easy Methods of Performing the Arithmetical Operations required in Commercial and Business Transactions; with Full Explanations of Decimals and Duodecimals; Tables, &c. By D. O'GORMAN. Twenty-fifth Edition, by Prof. J. R. YOUNG. 3s. ‡
204. **MATHEMATICAL TABLES,** for Trigonometrical, Astronomical, and Nautical Calculations; to which is prefixed a Treatise on Logarithms. By HENRY LAW, C.E. Together with a Series of Tables for Navigation and Nautical Astronomy. By Prof. J. R. YOUNG. New Edition. 4s. ‡
- 204\*. **LOGARITHMS.** With Mathematical Tables for Trigonometrical, Astronomical, and Nautical Calculations. By HENRY LAW, M.Inst.C.E. New and Revised Edition. (Forming part of the above Work). 3s. [*Just published.*]
221. **MEASURES, WEIGHTS, AND MONEYS OF ALL NATIONS,** and an Analysis of the Christian, Hebrew, and Mahometan Calendars. By W. S. B. WOOLHOUSE, F.R.A.S., F.S.S. Sixth Edition. 2s. ‡
227. **MATHEMATICS AS APPLIED TO THE CONSTRUCTIVE ARTS.** Illustrating the various processes of Mathematical Investigation, by means of Arithmetical and Simple Algebraical Equations and Practical Examples. By FRANCIS CAMPIN, C.E. Second Edition. 3s. ‡

**PHYSICAL SCIENCE, NATURAL PHILOSOPHY, ETC.**

1. **CHEMISTRY.** By Professor GEORGE FOWNES, F.R.S. With an Appendix on the Application of Chemistry to Agriculture. 1s.
2. **NATURAL PHILOSOPHY,** Introduction to the Study of. By C. TOMLINSON. Woodcuts. 1s. 6d.
6. **MECHANICS,** Rudimentary Treatise on. By CHARLES TOMLINSON. Illustrated. 1s. 6d.
7. **ELECTRICITY;** showing the General Principles of Electrical Science, and the purposes to which it has been applied. By Sir W. SNOW HARRIS, F.R.S., &c. With Additions by R. SABINE, C.E., F.S.A. 1s. 6d.
- 7\*. **GALVANISM.** By Sir W. SNOW HARRIS. New Edition by ROBERT SABINE, C.E., F.S.A. 1s. 6d.
8. **MAGNETISM;** being a concise Exposition of the General Principles of Magnetical Science, and the Purposes to which it has been applied. By Sir W. SNOW HARRIS. New Edition, revised and enlarged by H. M. NOAD, Ph.D. With 165 Woodcuts. 3s. 6d. ‡

 *The ‡ indicates that these vols. may be had strongly bound at 6d. extra.*

Physical Science, Natural Philosophy, etc., *continued.*

11. *THE ELECTRIC TELEGRAPH*; its History and Progress; with Descriptions of some of the Apparatus. By R. SABINE, C.E., F.S.A. 3s.
12. *PNEUMATICS*, for the Use of Beginners. By CHARLES TOMLINSON. Illustrated. 1s. 6d.
72. *MANUAL OF THE MOLLUSCA*; a Treatise on Recent and Fossil Shells. By Dr. S. P. WOODWARD, A.L.S. Fourth Edition. With Appendix by RALPH TATE, A.L.S., F.G.S. With numerous Plates and 300 Woodcuts. 6s. 6d. Cloth boards, 7s. 6d.
96. *ASTRONOMY*. By the late Rev. ROBERT MAIN, M.A. Third Edition, by WILLIAM THYNNE LYNN, B.A., F.R.A.S. 2s.
97. *STATICS AND DYNAMICS*, the Principles and Practice of; embracing also a clear development of Hydrostatics, Hydrodynamics, and Central Forces. By T. BAKER, C.E. 1s. 6d.
138. *TELEGRAPH*, Handbook of the; a Guide to Candidates for Employment in the Telegraph Service. By R. BOND. Fourth Edition. Including Questions on Magnetism, Electricity, and Practical Telegraphy, by W. MCGREGOR. 3s. ‡
173. *PHYSICAL GEOLOGY*, partly based on Major-General PORTLOCK's "Rudiments of Geology." By RALPH TATE, A.L.S., &c. Woodcuts. 2s.
174. *HISTORICAL GEOLOGY*, partly based on Major-General PORTLOCK's "Rudiments." By RALPH TATE, A.L.S., &c. Woodcuts. 2s. 6d.
- 173 & 174. *RUDIMENTARY TREATISE ON GEOLOGY*, Physical and Historical. Partly based on Major-General PORTLOCK's "Rudiments of Geology." By RALPH TATE, A.L.S., F.G.S., &c. In One Volume. 4s. 6d. ‡
- 183 & 184. *ANIMAL PHYSICS*, Handbook of. By Dr. LARDNER, D.C.L., & formerly Professor of Natural Philosophy and Astronomy in University College, Lond. With 520 Illustrations. In One Vol. 7s. 6d., cloth boards.
183. *ANIMAL PHYSICS*. By Dr. LARDNER. Part I., Chapters I.—VII. 4s.
184. *ANIMAL PHYSICS*. By Dr. LARDNER. Part II., Chapters VIII.—XVIII. 3s.

## FINE ARTS.

20. *PERSPECTIVE FOR BEGINNERS*. Adapted to Young Students and Amateurs in Architecture, Painting, &c. By GEORGE PYNE. 2s.
- 40 & 41. *GLASS STAINING, AND THE ART OF PAINTING ON GLASS*. From the German of Dr. GESSERT and EMANUEL OTTO FROMBERG. With an Appendix on THE ART OF ENAMELLING. 2s. 6d.
69. *MUSIC*, A Rudimentary and Practical Treatise on. With numerous Examples. By CHARLES CHILD SPENCER. 2s. 6d.
71. *PIANOFORTE*, The Art of Playing the. With numerous Exercises & Lessons from the Best Masters. By CHARLES CHILD SPENCER. 1s. 6d.
- 69-71. *MUSIC & THE PIANOFORTE*. In one vol. Half bound, 5s.
181. *PAINTING POPULARLY EXPLAINED*, including Fresco, Oil, Mosaic, Water Colour, Water-Glass, Tempera, Encaustic, Miniature, Painting on Ivory, Vellum, Pottery, Enamel, Glass, &c. With Historical Sketches of the Progress of the Art by THOMAS JOHN GULLICK, assisted by JOHN TIMBS, F.S.A. Fourth Edition, revised and enlarged. 5s. ‡
186. *A GRAMMAR OF COLOURING*, applied to Decorative Painting and the Arts. By GEORGE FIELD. New Edition, enlarged and adapted to the Use of the Ornamental Painter and Designer. By ELLIS A. DAVIDSON. With two new Coloured Diagrams, &c. 3s. ‡
246. *A DICTIONARY OF PAINTERS, AND HANDBOOK FOR PICTURE AMATEURS*; including Methods of Painting, Cleaning, Relining and Restoring, Schools of Painting, &c. With Notes on the Copyists and Imitators of each Master. By PHILIPPE DARVYL. 2s. 6d. ‡

 The ‡ indicates that these vols. may be had strongly bound at 6d. extra.

## INDUSTRIAL AND USEFUL ARTS.

23. *BRICKS AND TILES*, Rudimentary Treatise on the Manufacture of. By E. DOBSON, M.R.I.B.A. Illustrated, 3s.‡
67. *CLOCKS, WATCHES, AND BELLS*, a Rudimentary Treatise on. By Sir EDMUND BECKETT, LL.D., Q.C. Seventh Edition, revised and enlarged. 4s. 6d. limp; 5s. 6d. cloth boards.
- 83\*\*. *CONSTRUCTION OF DOOR LOCKS*. Compiled from the Papers of A. C. HOBBS, and Edited by CHARLES TOMLINSON, F.R.S. With Additions by ROBERT MALLET, M.I.C.E. Illus. 2s. 6d.
162. *THE BRASS FOUNDER'S MANUAL*; Instructions for Modelling, Pattern-Making, Moulding, Turning, Filing, Burnishing, Bronzing, &c. With copious Receipts, &c. By WALTER GRAHAM. 2s.‡
205. *THE ART OF LETTER PAINTING MADE EASY*. By J. G. BADENOCH. Illustrated with 12 full-page Engravings of Examples. 1s.
215. *THE GOLDSMITH'S HANDBOOK*, containing full Instructions for the Alloying and Working of Gold. By GEORGE E. GEE. 3s.‡
224. *COACH BUILDING*, A Practical Treatise, Historical and Descriptive. By J. W. BURGESS. 2s. 6d.‡
225. *THE SILVERSMITH'S HANDBOOK*, containing full Instructions for the Alloying and Working of Silver. By GEORGE E. GEE. 3s.‡
235. *PRACTICAL ORGAN BUILDING*. By W. E. DICKSON, M.A., Precentor of Ely Cathedral. Illustrated. 2s. 6d.‡
249. *THE HALL-MARKING OF JEWELLERY PRACTICALLY CONSIDERED*. By GEORGE E. GEE. 3s.‡

## MISCELLANEOUS VOLUMES.

36. *A DICTIONARY OF TERMS used in ARCHITECTURE, BUILDING, ENGINEERING, MINING, METALLURGY, ARCHÆOLOGY, the FINE ARTS, &c.* By JOHN WEALE. Fifth Edition. Revised by ROBERT HUNT, F.R.S. Illustrated. 5s. limp; 6s. cloth boards.
50. *THE LAW OF CONTRACTS FOR WORKS AND SERVICES*. By DAVID GIBBONS. Third Edition, enlarged. 3s.‡
112. *MANUAL OF DOMESTIC MEDICINE*. By R. GOODING, B.A., M.D. Intended as a Family Guide in all Cases of Accident and Emergency. Third Edition. 2s.‡
- 112\*. *MANAGEMENT OF HEALTH*. A Manual of Home and Personal Hygiene. By the Rev. JAMES BAIRD, B.A. 1s.
150. *LOGIC*, Pure and Applied. By S. H. EMMENS. 1s. 6d.
153. *SELECTIONS FROM LOCKE'S ESSAYS ON THE HUMAN UNDERSTANDING*. With Notes by S. H. EMMENS. 2s.
154. *GENERAL HINTS TO EMIGRANTS*. Notices of the various Fields for Emigration, Hints on Outfits, Useful Recipes, &c. 2s.
157. *THE EMIGRANT'S GUIDE TO NATAL*. By ROBERT JAMES MANN, F.R.A.S., F.M.S. Second Edition. Map. 2s.
193. *HANDBOOK OF FIELD FORTIFICATION*, intended for the Guidance of Officers Preparing for Promotion. By Major W. W. KNOLLYS, F.R.G.S. With 163 Woodcuts. 3s.‡
194. *THE HOUSE MANAGER*: Being a Guide to Housekeeping. Practical Cookery, Pickling and Preserving, Household Work, Dairy Management, the Table and Dessert, Cellarage of Wines, Home-brewing and Wine-making, the Boudoir and Dressing-room, Travelling, Stable Economy, Gardening Operations, &c. By AN OLD HOUSEKEEPER. 3s. 6d.‡
194. *HOUSE BOOK (The)*. Comprising:—I. THE HOUSE MANAGER. 112. By an OLD HOUSEKEEPER. II. DOMESTIC MEDICINE. By RALPH GOODING, M.D. III. MANAGEMENT OF HEALTH. By JAMES BAIRD. In One Vol., & strongly half-bound, 6s.
- 112\*.

 The ‡ indicates that these vols. may be had strongly bound at 6d. extra.

**EDUCATIONAL AND CLASSICAL SERIES.****HISTORY.**

1. **England, Outlines of the History of;** more especially with reference to the Origin and Progress of the English Constitution. By WILLIAM DOUGLAS HAMILTON, F.S.A., of Her Majesty's Public Record Office. 4th Edition, revised. 5s.; cloth boards, 6s.
5. **Greece, Outlines of the History of;** in connection with the Rise of the Arts and Civilization in Europe. By W. DOUGLAS HAMILTON, of University College, London, and EDWARD LEVIEN, M.A., of Balliol College, Oxford. 2s. 6d.; cloth boards, 3s. 6d.
7. **Rome, Outlines of the History of;** from the Earliest Period to the Christian Era and the Commencement of the Decline of the Empire. By EDWARD LEVIEN, of Balliol College, Oxford. Map, 2s. 6d.; cl. bds. 3s. 6d.
9. **Chronology of History, Art, Literature, and Progress,** from the Creation of the World to the Conclusion of the Franco-German War. The Continuation by W. D. HAMILTON, F.S.A. 3s.; cloth boards, 3s. 6d.
50. **Dates and Events in English History,** for the use of Candidates in Public and Private Examinations. By the Rev. E. RAND. 1s.

**ENGLISH LANGUAGE AND MISCELLANEOUS.**

11. **Grammar of the English Tongue,** Spoken and Written. With an Introduction to the Study of Comparative Philology. By HYDE CLARKE, D.C.L. Fourth Edition. 1s. 6d.
- 11\*. **Philology: Handbook of the Comparative Philology of English,** Anglo-Saxon, Frisian, Flemish or Dutch, Low or Platt Dutch, High Dutch or German, Danish, Swedish, Icelandic, Latin, Italian, French, Spanish, and Portuguese Tongues. By HYDE CLARKE, D.C.L. 1s.
12. **Dictionary of the English Language,** as Spoken and Written. Containing above 100,000 Words. By HYDE CLARKE, D.C.L. 3s. 6d.; cloth boards, 4s. 6d.; complete with the GRAMMAR, cloth bds., 5s. 6d.
48. **Composition and Punctuation,** familiarly Explained for those who have neglected the Study of Grammar. By JUSTIN BRENNAN. 17th Edition. 1s. 6d.
49. **Derivative Spelling-Book: Giving the Origin of Every Word** from the Greek, Latin, Saxon, German, Teutonic, Dutch, French, Spanish, and other Languages; with their present Acceptation and Pronunciation. By J. ROWBOTHAM, F.R.A.S. Improved Edition. 1s. 6d.
51. **The Art of Extempore Speaking: Hints for the Pulpit, the Senate, and the Bar.** By M. BAUTAIN, Vicar-General and Professor at the Sorbonne. Translated from the French. 7th Edition, carefully corrected. 2s. 6d.
52. **Mining and Quarrying,** with the Sciences connected therewith. First Book of, for Schools. By J. H. COLLINS, F.G.S., Lecturer to the Miners' Association of Cornwall and Devon. 1s.
53. **Places and Facts in Political and Physical Geography,** for Candidates in Examinations. By the Rev. EDGAR RAND, B.A. 1s.
54. **Analytical Chemistry, Qualitative and Quantitative,** a Course of. To which is prefixed, a Brief Treatise upon Modern Chemical Nomenclature and Notation. By WM. W. PINK and GEORGE E. WEBSTER. 2s.

**THE SCHOOL MANAGERS' SERIES OF READING BOOKS,**

Edited by the Rev. A. R. GRANT, Rector of Hitcham, and Honorary Canon of Ely; formerly H.M. Inspector of Schools.

## INTRODUCTORY PRIMER, 3d

	s.	d.		s.	d.
FIRST STANDARD . . .	0	6	FOURTH STANDARD . . .	1	2
SECOND " . . .	0	10	FIFTH " . . .	1	6
THIRD " . . .	1	0	SIXTH " . . .	1	6
LESSONS FROM THE BIBLE. Part I. Old Testament. 1s.					
LESSONS FROM THE BIBLE. Part II. New Testament, to which is added					
THE GEOGRAPHY OF THE BIBLE, for very young Children. By Rev. C.					
THORNTON FORSTER. 1s. 2d. ** Or the Two Parts in One Volume. 2s.					

7, STATIONERS' HALL COURT, LUDGATE HILL, E.C.

**FRENCH.**

24. **French Grammar.** With Complete and Concise Rules on the Genders of French Nouns. By G. L. STRAUSS, Ph.D. 1s. 6d.
25. **French-English Dictionary.** Comprising a large number of New Terms used in Engineering, Mining, &c. By ALFRED ELWES. 1s. 6d.
26. **English-French Dictionary.** By ALFRED ELWES. 2s.
- 25,26. **French Dictionary (as above).** Complete, in One Vol., 3s.; cloth boards, 3s. 6d. \*\*\* Or with the GRAMMAR, cloth boards, 4s. 6d.
47. **French and English Phrase Book;** containing Introductory Lessons, with Translations, several Vocabularies of Words, a Collection of suitable Phrases, and Easy Familiar Dialogues. 1s. 6d.

**GERMAN.**

39. **German Grammar.** Adapted for English Students, from Heyse's Theoretical and Practical Grammar, by Dr. G. L. STRAUSS. 1s. 6d.
40. **German Reader: A Series of Extracts,** carefully culled from the most approved Authors of Germany; with Notes, Philological and Explanatory. By G. L. STRAUSS, Ph.D. 1s.
- 41-43. **German Triglot Dictionary.** By N. E. S. A. HAMILTON. In Three Parts. Part I. German-French-English. Part II. English-German-French. Part III. French-German-English. 3s., or cloth boards, 4s.
- 41-43 & 39. **German Triglot Dictionary (as above),** together with German Grammar (No. 39), in One Volume, cloth boards, 5s.

**ITALIAN.**

27. **Italian Grammar,** arranged in Twenty Lessons, with a Course of Exercises. By ALFRED ELWES. 1s. 6d.
28. **Italian Triglot Dictionary,** wherein the Genders of all the Italian and French Nouns are carefully noted down. By ALFRED ELWES. Vol. 1. Italian-English-French. 2s. 6d.
30. **Italian Triglot Dictionary.** By A. ELWES. Vol. 2. English-French-Italian. 2s. 6d.
32. **Italian Triglot Dictionary.** By ALFRED ELWES. Vol. 3. French-Italian-English. 2s. 6d.
- 28,30,32. **Italian Triglot Dictionary (as above).** In One Vol., 7s. 6d. Cloth boards.

**SPANISH AND PORTUGUESE.**

34. **Spanish Grammar,** in a Simple and Practical Form. With a Course of Exercises. By ALFRED ELWES. 1s. 6d.
35. **Spanish-English and English-Spanish Dictionary.** Including a large number of Technical Terms used in Mining, Engineering, &c., with the proper Accents and the Gender of every Noun. By ALFRED ELWES. 4s.; cloth boards, 5s. \*\*\* Or with the GRAMMAR, cloth boards, 6s.
55. **Portuguese Grammar,** in a Simple and Practical Form. With a Course of Exercises. By ALFRED ELWES. 1s. 6d.
56. **Portuguese-English and English-Portuguese Dictionary.** Including a large number of Technical Terms used in Mining, Engineering, &c., with the proper Accents and the Gender of every Noun. By ALFRED ELWES. 5s.; cloth boards, 6s. \*\*\* Or with the GRAMMAR, cloth boards, 7s. [*Just published.*]

**HEBREW.**

- 46\*. **Hebrew Grammar.** By Dr. BRESSLAU. 1s. 6d.
44. **Hebrew and English Dictionary,** Biblical and Rabbinical; containing the Hebrew and Chaldee Roots of the Old Testament Post-Rabbinical Writings. By Dr. BRESSLAU. 6s.
46. **English and Hebrew Dictionary.** By Dr. BRESSLAU. 3s.
- 44,46. **Hebrew Dictionary (as above),** in Two Vols., complete, with 46\* the GRAMMAR, cloth boards, 12s.

## LATIN.

19. **Latin Grammar.** Containing the Inflections and Elementary Principles of Translation and Construction. By the Rev. THOMAS GOODWIN, M.A., Head Master of the Greenwich Proprietary School. 1s.
20. **Latin-English Dictionary.** By the Rev. THOMAS GOODWIN, M.A. 2s.
22. **English-Latin Dictionary;** together with an Appendix of French and Italian Words which have their origin from the Latin. By the Rev. THOMAS GOODWIN, M.A. 1s. 6d.
- 20, 22. **Latin Dictionary** (as above). Complete in One Vol., 3s. 6d. cloth boards, 4s. 6d. \* \* Or with the GRAMMAR, cloth boards, 5s. 6d.
- LATIN CLASSICS.** With Explanatory Notes in English.
1. **Latin Delectus.** Containing Extracts from Classical Authors, with Genealogical Vocabularies and Explanatory Notes, by H. YOUNG. 1s. 6d.
2. **Cæsaris Commentarii de Bello Gallico.** Notes, and a Geographical Register for the Use of Schools, by H. YOUNG. 2s.
3. **Cornelius Nepos.** With Notes. By H. YOUNG. 1s.
4. **Virgilii Maronis Bucolica et Georgica.** With Notes on the Bucolics by W. RUSHTON, M.A., and on the Georgics by H. YOUNG. 1s. 6d.
5. **Virgilii Maronis Æneis.** With Notes, Critical and Explanatory, by H. YOUNG. New Edition, revised and improved. With copious Additional Notes by Rev. T. H. L. LEARY, D.C.L., formerly Scholar of Brasenose College, Oxford. 3s.
- 5\* ——— Part 1. Books i.—vi., 1s. 6d.
- 5\*\* ——— Part 2. Books vii.—xii., 2s.
6. **Horace; Odes, Epode, and Carmen Sæculare.** Notes by H. YOUNG. 1s. 6d.
7. **Horace; Satires, Epistles, and Ars Poetica.** Notes by W. BROWNRIGG SMITH, M.A., F.R.G.S. 1s. 6d.
8. **Sallustii Crispi Catalina et Bellum Jugurthinum.** Notes, Critical and Explanatory, by W. M. DONNE, B.A., Trin. Coll., Cam. 1s. 6d.
9. **Terentii Andria et Heautontimorumenos.** With Notes, Critical and Explanatory, by the Rev. JAMES DAVIES, M.A. 1s. 6d.
10. **Terentii Adelphi, Hecyra, Phormio.** Edited, with Notes, Critical and Explanatory, by the Rev. JAMES DAVIES, M.A. 2s.
11. **Terentii Eunuchus, Comœdia.** Notes, by Rev. J. DAVIES, M.A. 1s. 6d.
12. **Ciceronis Oratio pro Sexto Roscio Amerino.** Edited, with an Introduction, Analysis, and Notes, Explanatory and Critical, by the Rev. JAMES DAVIES, M.A. 1s. 6d.
13. **Ciceronis Orationes in Catilinam, Verrem, et pro Archia.** With Introduction, Analysis, and Notes, Explanatory and Critical, by Rev. T. H. L. LEARY, D.C.L. formerly Scholar of Brasenose College, Oxford. 1s. 6d.
14. **Ciceronis Cato Major, Lælius, Brutus, sive de Senectute, de Amicitia, de Claris Oratoribus Dialogi.** With Notes by W. BROWNRIGG SMITH, M.A., F.R.G.S. 2s.
16. **Livy: History of Rome.** Notes by H. YOUNG and W. B. SMITH, M.A. Part 1. Books i., ii., 1s. 6d.
- 16\* ——— Part 2. Books iii., iv., v., 1s. 6d.
17. ——— Part 3. Books xxi., xxii., 1s. 6d.
19. **Latin Verse Selections,** from Catullus, Tibullus, Propertius, and Ovid. Notes by W. B. DONNE, M.A., Trinity College, Cambridge. 2s.
20. **Latin Prose Selections,** from Varro, Columella, Vitruvius, Seneca, Quintilian, Florus, Velleius Paterculus, Valerius Maximus Suetonius, Apuleius, &c. Notes by W. B. DONNE, M.A. 2s.
21. **Juvenalis Satiræ.** With Prolegomena and Notes by T. H. S. ESCOTT, B.A., Lecturer on Logic at King's College, London. 2s.



## GREEK.

14. **Greek Grammar**, in accordance with the Principles and Philological Researches of the most eminent Scholars of our own day. By HANS CLAUDE HAMILTON. 1s. 6d.
- 15,17. **Greek Lexicon**. Containing all the Words in General Use, with their Significations, Inflections, and Doubtful Quantities. By HENRY R. HAMILTON. Vol. 1. Greek-English, 2s. 6d.; Vol. 2. English-Greek, 2s. Or the Two Vols. in One, 4s. 6d.: cloth boards, 5s.
- 14,15. **Greek Lexicon** (as above). Complete, with the GRAMMAR, in 17. One Vol., cloth boards, 6s.

## GREEK CLASSICS. With Explanatory Notes in English.

1. **Greek Delectus**. Containing Extracts from Classical Authors, with Genealogical Vocabularies and Explanatory Notes, by H. YOUNG. New Edition, with an improved and enlarged Supplementary Vocabulary, by JOHN HUTCHISON, M.A., of the High School, Glasgow. 1s. 6d.
- 2, 3. **Xenophon's Anabasis; or, The Retreat of the Ten Thousand**. Notes and a Geographical Register, by H. YOUNG. Part 1. Books i. to iii., 1s. Part 2. Books iv. to vii., 1s.
4. **Lucian's Select Dialogues**. The Text carefully revised, with Grammatical and Explanatory Notes, by H. YOUNG. 1s. 6d.
- 5-12. **Homer, The Works of**. According to the Text of BAUMLEIN. With Notes, Critical and Explanatory, drawn from the best and latest Authorities, with Preliminary Observations and Appendices, by T. H. L. LEARY, M.A., D.C.L.
- |              |                                     |   |
|--------------|-------------------------------------|---|
| THE ILIAD:   | Part 1. Books i. to vi., 1s. 6d.    | Part 3. Books xiii. to xviii., 1s. 6d.      |
|              | Part 2. Books vii. to xii., 1s. 6d. | Part 4. Books xix. to xxiv., 1s. 6d.        |
| THE ODYSSEY: | Part 1. Books i. to vi., 1s. 6d.    | Part 3. Books xiii. to xviii., 1s. 6d.      |
|              | Part 2. Books vii. to xii., 1s. 6d. | Part 4. Books xix. to xxiv., and Hymns, 2s. |
13. **Plato's Dialogues: The Apology of Socrates, the Crito, and the Phædo**. From the Text of C. F. HERMANN. Edited with Notes, Critical and Explanatory, by the Rev. JAMES DAVIES, M.A. 2s.
- 14-17. **Herodotus, The History of**, chiefly after the Text of GAISFORD. With Preliminary Observations and Appendices, and Notes, Critical and Explanatory, by T. H. L. LEARY, M.A., D.C.L.
- |   |
|---|
| Part 1. Books i., ii. (The Clio and Euterpe), 2s.                     |
| Part 2. Books iii., iv. (The Thalia and Melpomene), 2s.               |
| Part 3. Books v.-vii. (The Terpsichore, Erato, and Polymnia), 2s.     |
| Part 4. Books viii., ix. (The Urania and Calliope) and Index, 1s. 6d. |
18. **Sophocles: Œdipus Tyrannus**. Notes by H. YOUNG. 1s.
20. **Sophocles: Antigone**. From the Text of DINDORF. Notes, Critical and Explanatory, by the Rev. JOHN MILNER, B.A. 2s.
23. **Euripides: Hecuba and Medea**. Chiefly from the Text of DINDORF. With Notes, Critical and Explanatory, by W. BROWNRIGG SMITH, M.A., F.R.G.S. 1s. 6d.
26. **Euripides: Alcestis**. Chiefly from the Text of DINDORF. With Notes, Critical and Explanatory, by JOHN MILNER, B.A. 1s. 6d.
30. **Æschylus: Prometheus Vincetus: The Prometheus Bound**. From the Text of DINDORF. Edited, with English Notes, Critical and Explanatory, by the Rev. JAMES DAVIES, M.A. 1s.
32. **Æschylus: Septem Contra Thebes: The Seven against Thebes**. From the Text of DINDORF. Edited, with English Notes, Critical and Explanatory, by the Rev. JAMES DAVIES, M.A. 1s.
40. **Aristophanes: Acharnians**. Chiefly from the Text of C. H. WEISE. With Notes, by C. S. T. TOWNSHEND, M.A. 1s. 6d.
41. **Thucydides: History of the Peloponnesian War**. Notes by H. YOUNG. Book 1. 1s.
42. **Xenophon's Panegyric on Agesilaus**. Notes and Introduction by LL. F. W. JEWITT. 1s. 6d.
43. **Demosthenes. The Oration on the Crown and the Philippics**. With English Notes. By Rev. T. H. L. LEARY, D.C.L., formerly Scholar of Brasenose College, Oxford. 1s. 6d.

LONDON, *May*, 1884.

# A Catalogue of Books

INCLUDING MANY NEW AND STANDARD WORKS IN  
**ENGINEERING, ARCHITECTURE, AGRICULTURE,  
MATHEMATICS, MECHANICS, SCIENCE, ETC.**

PUBLISHED BY

**CROSBY LOCKWOOD & CO.,**  
7, STATIONERS'-HALL COURT, LUDGATE HILL, E.C.

---

**ENGINEERING, SURVEYING, ETC.**

---

## *Humber's Work on Water-Supply.*

A COMPREHENSIVE TREATISE on the WATER-SUPPLY of CITIES and TOWNS. By WILLIAM HUMBER, A.-M. Inst. C.E., and M. Inst. M.E. Illustrated with 50 Double Plates, 1 Single Plate, Coloured Frontispiece, and upwards of 250 Woodcuts, and containing 400 pages of Text. Imp. 4to, 6*l.* 6*s.* elegantly and substantially half-bound in morocco.

### *List of Contents:—*

I. Historical Sketch of some of the means that have been adopted for the Supply of Water to Cities and Towns.—II. Water and the Foreign Matter usually associated with it.—III. Rainfall and Evaporation.—IV. Springs and the water-bearing formations of various districts.—V. Measurement and Estimation of the Flow of Water.—VI. On the Selection of the Source of Supply.—VII. Wells.—VIII. Reservoirs.—IX. The Purification of Water.—X. Pumps.—XI. Pumping Machinery.—XII. Conduits.—XIII. Distribution of Water.—XIV. Meters, Service Pipes, and House Fittings.—XV. The Law and Economy of Water Works.—XVI. Constant and Intermittent Supply.—XVII. Description of Plates.—Appendices, giving Tables of Rates of Supply, Velocities, &c. &c., together with Specifications of several Works illustrated, among which will be found:—Aberdeen, Bideford, Canterbury, Dundee, Halifax, Lambeth, Rotherham, Dublin, and others.

“The most systematic and valuable work upon water supply hitherto produced in English, or in any other language . . . Mr. Humber's work is characterised almost throughout by an exhaustiveness much more distinctive of French and German than of English technical treatises.”—*Engineer*.

## *Humber's Work on Bridge Construction.*

A COMPLETE and PRACTICAL TREATISE on CAST and WROUGHT-IRON BRIDGE CONSTRUCTION, including Iron Foundations. In Three Parts—Theoretical, Practical, and Descriptive. By WILLIAM HUMBER, A.-M. Inst. C.E., and M. Inst. M.E. Third Edition, with 115 Double Plates. In 2 vols. imp. 4to, 6*l.* 16*s.* 6*d.* half-bound in morocco.

“A book—and particularly a large and costly treatise like Mr. Humber's—which has reached its third edition may certainly be said to have established its own reputation.”—*Engineering*.

*Humber's Modern Engineering.*

A RECORD of the PROGRESS of MODERN ENGINEERING. First Series. Comprising Civil, Mechanical, Marine, Hydraulic, Railway, Bridge, and other Engineering Works, &c. By WILLIAM HUMBER, A.-M. Inst. C.E., &c. Imp. 4to, with 36 Double Plates, drawn to a large scale, and Portrait of John Hawkshaw, C.E., F.R.S., &c., and descriptive Letter-press, Specifications, &c. 3*l.* 3*s.* half morocco.

*List of the Plates and Diagrams.*

Victoria Station and Roof, L. B. & S. C. R. (8 plates); Southport Pier (2 plates); Victoria Station and Roof, L. C. & D. and G. W. R. (6 plates); Roof of Cremorne Music Hall; Bridge over G. N. Railway; Roof of Station, Dutch Rhenish Rail (2	plates); Bridge over the Thames, West London Extension Railway (5 plates); Armour Plates; Suspension Bridge, Thames (4 plates); The Allen Engine; Suspension Bridge, Avon (3 plates); Underground Railway (3 plates).
--	---

HUMBER'S RECORD OF MODERN ENGINEERING. Second Series. Imp. 4to, with 36 Double Plates, Portrait of Robert Stephenson, C.E., &c., and descriptive Letterpress, Specifications, &c. 3*l.* 3*s.* half morocco.

*List of the Plates and Diagrams.*

Birkenhead Docks, Low Water Basin (15 plates); Charing Cross Station Roof, C. C. Railway (3 plates); Digswell Viaduct, G. N. Railway; Robbery Wood Viaduct, G. N. Railway; Iron Permanent Way; Clydach Viaduct, Merthyr, Tredegar, and Abergavenny Railway; Ebbw	Viaduct, Merthyr, Tredegar, and Abergavenny Railway; College Wood Viaduct, Cornwall Railway; Dublin Winter Palace Roof (3 plates); Bridge over the Thames, L. C. and D. Railway (6 plates); Albert Harbour, Greenock (4 plates).
--	--

HUMBER'S RECORD OF MODERN ENGINEERING. Third Series. Imp. 4to, with 40 Double Plates, Portrait of J. R. M'Clean, Esq., late Pres. Inst. C.E., and descriptive Letterpress, Specifications, &c. 3*l.* 3*s.* half morocco.

*List of the Plates and Diagrams.*

MAIN DRAINAGE, METROPOLIS.— <i>North Side.</i> —Map showing Interception of Sewers; Middle Level Sewer (2 plates); Outfall Sewer, Bridge over River Lea (3 plates); Outfall Sewer, Bridge over Marsh Lane, North Woolwich Railway, and Bow and Barking Railway Junction; Outfall Sewer, Bridge over Bow and Barking Railway (3 plates); Outfall Sewer, Bridge over East London Waterworks' Feeder (2 plates); Outfall Sewer, Reservoir (2 plates); Outfall Sewer, Tumbling Bay and Outlet; Outfall Sewer, Penstocks. <i>South Side.</i> —Outfall Sewer, Bermondsey	Branch (2 plates); Outfall Sewer, Reservoir and Outlet (4 plates); Outfall Sewer, Filth Hoist; Sections of Sewers (North and South Sides). THAMES EMBANKMENT.—Section of River Wall; Steamboat Pier, Westminster (2 plates); Landing Stairs between Charing Cross and Waterloo Bridges; York Gate (2 plates); Overflow and Outlet at Savoy Street Sewer (3 plates); Steamboat Pier, Waterloo Bridge (3 plates); Junction of Sewers, Plans and Sections; Gullies, Plans and Sections; Rolling Stock; Granite and Iron Forts.
--	--

HUMBER'S RECORD OF MODERN ENGINEERING. Fourth Series. Imp. 4to, with 36 Double Plates, Portrait of John Fowler, Esq., late Pres. Inst. C.E., and descriptive Letterpress, Specifications, &c. 3*l.* 3*s.* half morocco.

*List of the Plates and Diagrams.*

Abbey Mills Pumping Station, Main Drainage, Metropolis (4 plates); Barrow Docks (5 plates); Manquis Viaduct, Santiago and Valparaiso Railway (2 plates); Adam's Locomotive, St. Helen's Canal Railway (2 plates); Cannon Street Station Roof, Charing Cross Railway (3 plates); Road Bridge over the River Moka (2 plates); Telegraphic Apparatus for Meso-	potamia; Viaduct over the River Wye, Midland Railway (3 plates); St. German's Viaduct, Cornwall Railway (2 plates); Wrought-Iron Cylinder for Diving Bell; Millwall Docks (6 plates); Milroy's Patent Excavator, Metropolitan District Railway (6 plates); Harbours, Ports, and Breakwaters (3 plates).
---	---

*Strains in Iron Frameworks, &c.*

GRAPHIC AND ANALYTIC STATICS IN THEORY AND COMPARISON. Their Practical Application to the Treatment of Stresses in Roofs, Solid Girders, Lattice, Bowstring and Suspension Bridges, Braced Iron Arches and Piers, and other Frameworks. To which is added a Chapter on Wind Pressures. By R. HUDSON GRAHAM, C.E. With numerous Examples, many taken from existing Structures. 8vo., 16s. cloth.

"Mr. Graham's book will find a place wherever graphic and analytic statics are used or studied."—*Engineer*.

"This exhaustive treatise is admirably adapted for the architect and engineer, and will tend to wean the profession from a tedious and laboured mode of calculation. To prove the accuracy of the graphical demonstrations, the author compares them with the analytic formulæ given by Rankine."—*Building News*.

*Strength of Girders.*

GRAPHIC TABLE for FACILITATING the COMPUTATION of the WEIGHTS of WROUGHT-IRON and STEEL GIRDERS, &c., for Parliamentary and other Estimates. By J. H. WATSON BUCK, M. Inst. C. E. On a Sheet, 2s. 6d.

*Strains, Formulæ & Diagrams for Calculation of.*

A HANDY BOOK for the CALCULATION of STRAINS in GIRDERS and SIMILAR STRUCTURES, and their STRENGTH; consisting of Formulæ and Corresponding Diagrams, with numerous Details for Practical Application, &c. By WILLIAM HUMBER, A.-M. Inst. C. E., &c. Third Edition. Cr. 8vo, 7s. 6d. cl.

*Strains.*

THE STRAINS ON STRUCTURES OF IRONWORK; with Practical Remarks on Iron Construction. By F. W. SHEILDS, M. Inst. C.E. Second Edition, with 5 Plates. Royal 8vo, 5s. cloth.

"The student cannot find a better book on this subject than Mr. Sheilds'."—*Engineer*.

*Barlow on the Strength of Materials, enlarged.*

A TREATISE ON THE STRENGTH OF MATERIALS, with Rules for application in Architecture, the Construction of Suspension Bridges, Railways, &c. By PETER BARLOW, F.R.S. Revised by his Sons, P. W. and W. H. BARLOW. Edited by W. HUMBER, A.-M. Inst. C.E. 8vo, 18s. cloth.

"The standard treatise upon this particular subject."—*Engineer*.

*Strength of Cast Iron, &c.*

A PRACTICAL ESSAY on the STRENGTH of CAST IRON and OTHER METALS. By T. TREDGOLD, C.E. 5th Edition. To which are added, Experimental Researches on the Strength, &c., of Cast Iron. By E. HODGKINSON, F.R.S. 8vo, 12s. cloth.

\* \* \* HODGKINSON'S RESEARCHES, separate, price 6s.

*Hydraulics.*

HYDRAULIC TABLES, CO-EFFICIENTS, and FORMULÆ for finding the Discharge of Water from Orifices, Notches, Weirs, Pipes, and Rivers. With New Formulæ, Tables, and General Information on Rain-fall, Catchment-Basins, Drainage, Sewerage, and Water Supply. By J. NEVILLE, C.E., M.R.I.A. Third Edition, Revised and Enlarged. Crown 8vo, 14s. cloth.

### *Hydraulics.*

HYDRAULIC MANUAL. Consisting of Working Tables and Explanatory Text. Intended as a Guide in Hydraulic Calculations and Field Operations. By **LOWIS D'A. JACKSON**. Fourth Edition. Rewritten and Enlarged. Large Crown 8vo. 16s. cloth.

"We heartily recommend this volume to all who desire to be acquainted with the latest development of this important subject."—*Engineering*.

"The standard work in this department of mechanics. The present edition has been brought abreast of the most recent practice."—*Scotsman*.

### *River Engineering.*

RIVER BARS: The Causes of their Formation, and their Treatment by 'Induced Tidal Scour,' with a Description of the Successful Reduction by this Method of the Bar at Dublin. By **I. J. MANN**, Assis. Eng. to the Dublin Port and Docks Board. Rl. 8vo. 7s. 6d. cl.

### *Levelling.*

A TREATISE on the PRINCIPLES and PRACTICE of LEVELLING; showing its Application to Purposes of Railway and Civil Engineering, in the Construction of Roads; with Mr. TELFORD'S Rules for the same. By **FREDERICK W. SIMMS**, F.G.S., M. Inst. C.E. Sixth Edition, very carefully revised, with the addition of Mr. LAW'S Practical Examples for Setting out Railway Curves, and Mr. TRAUTWINE'S Field Practice of Laying out Circular Curves. With 7 Plates and numerous Woodcuts. 8vo, 8s. 6d. cloth. \* \* TRAUTWINE on Curves, separate, 5s.

### *Practical Tunnelling.*

PRACTICAL TUNNELLING: Explaining in detail the Setting out of the Works, Shaft-sinking and Heading-Driving, Ranging the Lines and Levelling under Ground, Sub-Excavating, Timbering, and the Construction of the Brickwork of Tunnels with the amount of labour required for, and the Cost of, the various portions of the work. By **F. W. SIMMS**, M. Inst. C.E. Third Edition, Revised and Extended. By **D. KINNEAR CLARK**, M.I.C.E. Imp. 8vo, with 21 Folding Plates and numerous Wood Engravings, 30s. cloth.

### *Civil and Hydraulic Engineering.*

CIVIL ENGINEERING. By **HENRY LAW**, M. Inst. C.E. Including a Treatise on Hydraulic Engineering, by **GEORGE R. BURNELL**, M.I.C.E. Seventh Edition, Revised, with large additions, by **D. KINNEAR CLARK**, M. Inst. C.E. 7s. 6d., cloth.

### *Gas-Lighting.*

COMMON SENSE FOR GAS-USERS: a Catechism of Gas-Lighting for Householders, Gasfitters, Millowners, Architects, Engineers, &c. By **R. WILSON**, C.E. 2nd Edition. Cr. 8vo, 2s. 6d.

### *Earthwork.*

EARTHWORK TABLES, showing the Contents in Cubic Yards of Embankments, Cuttings, &c., of Heights or Depths up to an average of 80 feet. By **JOSEPH BROADBENT**, C.E., and **FRANCIS CAMPIN**, C.E. Cr. 8vo, oblong, 5s. cloth.

*Tramways and their Working.*

TRAMWAYS : THEIR CONSTRUCTION and WORKING. Embracing a Comprehensive History of the System, with an Exhaustive Analysis of the various modes of Traction, including Horse-power, Steam, Heated Water, and Compressed Air; a Description of the Varieties of Rolling Stock, and Ample Details of Cost and Working Expenses; the Progress recently made in Tramway Construction, &c., &c. By D. KINNEAR CLARK, M. Inst. C. E. With over 200 Wood Engravings, and 13 Folding Plates. 2 vols. Large Crown 8vo, 30s. cloth.

"All interested in tramways must refer to it, as all railway engineers have turned to the author's work 'Railway Machinery.'"—*The Engineer*.

"The work is based on former tramway experience, and is specially valuable in these days of rapid change and progress."—*Engineering*.

*Steam.*

STEAM AND THE STEAM ENGINE, Stationary and Portable. Being an Extension of Sewell's Treatise on Steam. By D. KINNEAR CLARK, M.I.C.E. Second Edition. 12mo, 4s. cloth.

*Steam Engine.*

TEXT-BOOK ON THE STEAM ENGINE. By T. M. GOODEVE, M.A., Barrister-at-Law, Author of "The Principles of Mechanics," "The Elements of Mechanism," &c. Fifth Edition. With numerous Illustrations. Crown 8vo, 6s. cloth.

"Mr. Goodeve's text-book is a work of which every young engineer should possess himself."—*Mining Journal*.

*The High-Pressure Steam Engine.*

THE HIGH-PRESSURE STEAM ENGINE. By DR. ERNST ALBAN. Translated from the German, with Notes, by Dr. POLE, F.R.S. Plates. 8vo, 16s. 6d., cloth.

*Steam.*

THE SAFE USE OF STEAM : containing Rules for Unprofessional Steam Users. By an ENGINEER. 5th Edition. Sewed, 6d.

"If steam-users would but learn this little book by heart, boiler explosions would become sensations by their rarity."—*English Mechanic*.

*Mechanical Engineering.*

DETAILS OF MACHINERY : Comprising Instructions for the Execution of various Works in Iron, in the Fitting-Shop, Foundry, and Boiler-Yard. By FRANCIS CAMPIN, C.E. 3s. 6d. cloth.

*Mechanical Engineering.*

MECHANICAL ENGINEERING : Comprising Metallurgy, Moulding, Casting, Forging, Tools, Workshop Machinery, Manufacture of the Steam Engine, &c. By F. CAMPIN, C.E. 3s. cloth.

*Works of Construction.*

MATERIALS AND CONSTRUCTION : a Theoretical and Practical Treatise on the Strains, Designing, and Erection of Works of Construction. By F. CAMPIN, C.E. 12mo, 3s. 6d. cl. brds.

*Iron Bridges, Girders, Roofs, &c.*

A TREATISE ON THE APPLICATION OF IRON TO THE CONSTRUCTION OF BRIDGES, GIRDERS, ROOFS, AND OTHER WORKS. By F. CAMPIN, C.E. 12mo, 3s.

*Bridge Construction in Masonry, Timber, & Iron.*

EXAMPLES OF BRIDGE AND VIADUCT CONSTRUCTION IN MASONRY, TIMBER, AND IRON ; consisting of 46 Plates from the Contract Drawings or Admeasurement of select Works. By W. DAVIS HASKOLL, C.E. Second Edition, with the addition of 554 Estimates, and the Practice of Setting out Works, with 6 pages of Diagrams. Imp. 4to, 2l. 12s. 6d. half-morocco.

"A work of the present nature by a man of Mr. Haskoll's experience, must prove invaluable. The tables of estimates considerably enhance its value."—*Engineering*.

*Oblique Bridges.*

A PRACTICAL and THEORETICAL ESSAY on OBLIQUE BRIDGES, with 13 large Plates. By the late GEO. WATSON BUCK, M.I.C.E. Third Edition, revised by his Son, J. H. WATSON BUCK, M.I.C.E. ; and with the addition of Description to Diagrams for Facilitating the Construction of Oblique Bridges, by W. H. BARLOW, M.I.C.E. Royal 8vo, 12s. cloth.

"The standard text book for all engineers regarding skew arches."—*Engineer*.

*Oblique Arches.*

A PRACTICAL TREATISE ON THE CONSTRUCTION OF OBLIQUE ARCHES. By JOHN HART. 3rd Ed. Imp. 8vo, 8s. cloth.

*Boiler Construction.*

THE MECHANICAL ENGINEER'S OFFICE BOOK : Boiler Construction. By NELSON FOLEY, Cardiff, late Assistant Manager Palmer's Engine Works, Jarrow. With 29 full-page Lithographic Diagrams. Folio, 21s. half-bound.

*Locomotive-Engine Driving.*

LOCOMOTIVE-ENGINE DRIVING ; a Practical Manual for Engineers in charge of Locomotive Engines. By MICHAEL REYNOLDS, M.S.E. Sixth Edition. Including A KEY TO THE LOCOMOTIVE ENGINE. With Illustrations. Cr. 8vo, 4s. 6d. cl.

"Mr. Reynolds has supplied a want, and has supplied it well."—*Engineer*.

*The Engineer, Fireman, and Engine-Boy.*

THE MODEL LOCOMOTIVE ENGINEER, FIREMAN, AND ENGINE-BOY. By M. REYNOLDS. Crown 8vo, 4s. 6d.

*Stationary Engine Driving.*

STATIONARY ENGINE DRIVING. A Practical Manual for Engineers in Charge of Stationary Engines. By MICHAEL REYNOLDS. Second Edition, Revised and Enlarged. With Plates and Woodcuts. Crown 8vo, 4s. 6d. cloth.

*Engine-Driving Life.*

ENGINE-DRIVING LIFE ; or Stirring Adventures and Incidents in the Lives of Locomotive Engine-Drivers. By MICHAEL REYNOLDS. Eighth Thousand. Crown 8vo, 2s. cloth.

*Continuous Railway Brakes.*

CONTINUOUS RAILWAY BRAKES. A Practical Treatise on the several Systems in Use in the United Kingdom ; their Construction and Performance. With copious Illustrations and numerous Tables. By MICHAEL REYNOLDS. Large Crown 8vo, 9s. cloth.

*Construction of Iron Beams, Pillars, &c.*

IRON AND HEAT ; exhibiting the Principles concerned in the construction of Iron Beams, Pillars, and Bridge Girders, and the Action of Heat in the Smelting Furnace. By J. ARMOUR, C.E. 3s.

*Fire Engineering.*

FIRES, FIRE-ENGINES, AND FIRE BRIGADES. With a History of Fire-Engines, their Construction, Use, and Management ; Remarks on Fire-Proof Buildings, and the Preservation of Life from Fire ; Statistics of the Fire Appliances in English Towns ; Foreign Fire Systems ; Hints on Fire Brigades, &c., &c. By CHARLES F. T. YOUNG, C.E. Demy 8vo, 1l. 4s. cloth.

*Trigonometrical Surveying.*

AN OUTLINE OF THE METHOD OF CONDUCTING A TRIGONOMETRICAL SURVEY, for the Formation of Geographical and Topographical Maps and Plans, Military Reconnaissance, Levelling, &c., with the most useful Problems in Geodesy and Practical Astronomy. By LIEUT.-GEN. FROME, R.E., late Inspector-General of Fortifications. Fourth Edition, Enlarged, and partly Re-written. By CAPTAIN CHARLES WARREN, R.E. With 19 Plates and 115 Woodcuts, royal 8vo, 16s. cloth.

*Tables of Curves.*

TABLES OF TANGENTIAL ANGLES and MULTIPLES for setting out Curves from 5 to 200 Radius. By ALEXANDER BEAZELEY, M. Inst. C.E. Third Edition. Printed on 48 Cards, and sold in a cloth box, waistcoat-pocket size, 3s. 6d.

‘ Each table is printed on a small card, which, being placed on the theodolite, leaves the hands free to manipulate the instrument.’—*Engineer*.

“ Very handy ; a man may know that all his day’s work must fall on two of these cards, which he puts into his own card-case, and leaves the rest behind.”—*Athenæum*.

*Pioneer Engineering.*

PIONEER ENGINEERING. A Treatise on the Engineering Operations connected with the Settlement of Waste Lands in New Countries. By EDWARD DOBSON, A.I.C.E. With Plates and Wood Engravings. Revised Edition. 12mo, 5s. cloth.

“ A workmanlike production, and one without possession of which no man should start to encounter the duties of a pioneer engineer.”—*Athenæum*.

*Engineering Fieldwork.*

THE PRACTICE OF ENGINEERING FIELDWORK, applied to Land and Hydraulic, Hydrographic, and Submarine Surveying and Levelling. Second Edition, revised, with considerable additions, and a Supplement on WATERWORKS, SEWERS, SEWAGE, and IRRIGATION. By W. DAVIS HASKOLL, C.E. Numerous folding Plates. In 1 Vol., demy 8vo, 1l. 5s., cl. boards.

*Large Tunnel Shafts.*

THE CONSTRUCTION OF LARGE TUNNEL SHAFTS. By J. H. WATSON BUCK, M. Inst. C.E., &c. Illustrated with Folding Plates. Royal 8vo, 12s. cloth.

“ Many of the methods given are of extreme practical value to the mason, and the observations on the form of arch, the rules for ordering the stone, and the construction of the templates, will be found of considerable use. We commend the book to the profession, and to all who have to build similar shafts.”—*Building News*.



### *Survey Practice.*

AID TO SURVEY PRACTICE: for Reference in Surveying, Levelling, Setting-out and in Route Surveys of Travellers by Land and Sea. With Tables, Illustrations, and Records. By **LOWIS D'A. JACKSON, A.-M.I.C.E.** Author of "Hydraulic Manual and Statistics," &c. Large crown 8vo, 12s. 6d., cloth.

"Mr. Jackson has had much and varied experience in field work and some knowledge of bookmaking, and he has utilised both these acquirements with a very useful result. The volume covers the ground it occupies very thoroughly."—*Engineering.*

### *Sanitary Work.*

SANITARY WORK IN THE SMALLER TOWNS AND IN VILLAGES. Comprising:—1. Some of the more Common Forms of Nuisance and their Remedies; 2. Drainage; 3. Water Supply. By **CHAS. SLAGG, Assoc. M. Inst. C.E.** Second Edition, Revised and Enlarged. 3s. 6d., cloth boards.

"This book contains all that such a treatise can be expected to contain, and is sound and trustworthy in every particular."—*Builder.*

### *Gas and Gasworks.*

THE CONSTRUCTION OF GASWORKS AND THE MANUFACTURE AND DISTRIBUTION OF COAL-GAS. Originally written by **S. HUGHES, C.E.** Sixth Edition. Re-written and enlarged, by **W. RICHARDS, C.E.** 12mo, 5s. cloth.

### *Waterworks for Cities and Towns.*

WATERWORKS for the SUPPLY of CITIES and TOWNS, with a Description of the Principal Geological Formations of England as influencing Supplies of Water. By **S. HUGHES.** 4s. 6d. cloth.

### *Coal and Speed Tables.*

POCKET BOOK OF COAL AND SPEED TABLES: for Engineers and Steam-Users. By **NELSON FOLEY,** Author of "Boiler Construction." [Nearly ready.]

### *Fuels and their Economy.*

FUEL, its Combustion and Economy; consisting of an Abridgment of "A Treatise on the Combustion of Coal and the Prevention of Smoke." By **C. W. WILLIAMS, A.I.C.E.** With extensive additions on Recent Practice in the Combustion and Economy of Fuel—Coal, Coke, Wood, Peat, Petroleum, &c.; by **D. KINNEAR CLARK, M. Inst. C.E.** Second Edition. 4s. cloth.

"Students should buy the book and read it, as one of the most complete and satisfactory treatises on the combustion and economy of fuel to be had."—*Engineer.*

### *Roads and Streets.*

THE CONSTRUCTION OF ROADS AND STREETS. In Two Parts. I. The Art of Constructing Common Roads. By **HENRY LAW, C.E.** Revised and Condensed. II. Recent Practice in the Construction of Roads and Streets: including Pavements of Stone, Wood, and Asphalte. By **D. KINNEAR CLARK, M. Inst. C.E.** Second Edit., revised. 12mo, 5s. cloth.

"A book which every borough surveyor and engineer must possess, and of considerable service to architects, builders, and property owners."—*Building News.*

### *Locomotives.*

LOCOMOTIVE ENGINES, A Rudimentary Treatise on. Comprising an Historical Sketch and Description of the Locomotive Engine. By G. D. DEMPSEY, C.E. With large additions treating of the MODERN LOCOMOTIVE, by D. KINNEAR CLARK, M. Inst. C.E. With Illustrations. 12mo. 3s. 6d., cloth boards.

"The student cannot fail to profit largely by adopting this as his preliminary textbook."—*Iron and Coal Trades Review*.

### *Field-Book for Engineers.*

THE ENGINEER'S, MINING SURVEYOR'S, and CONTRACTOR'S FIELD-BOOK. By W. DAVIS HASKOLL, C.E. Consisting of a Series of Tables, with Rules, Explanations of Systems, and Use of Theodolite for Traverse Surveying and Plotting the Work with minute accuracy by means of Straight Edge and Set Square only; Levelling with the Theodolite, Casting out and Reducing Levels to Datum, and Plotting Sections in the ordinary manner; Setting out Curves with the Theodolite by Tangential Angles and Multiples with Right and Left-hand Readings of the Instrument; Setting out Curves without Theodolite on the System of Tangential Angles by Sets of Tangents and Offsets; and Earthwork Tables to 80 feet deep, calculated for every 6 inches in depth. With numerous Woodcuts. 4th Edition, enlarged. Cr. 8vo. 12s. cloth.

"The book is very handy, and the author might have added that the separate tables of sines and tangents to every minute will make it useful for many other purposes, the genuine traverse tables existing all the same."—*Ashenæum*.

### *Earthwork, Measurement and Calculation of.*

A MANUAL on EARTHWORK. By ALEX. J. S. GRAHAM, C.E. With numerous Diagrams. 18mo, 2s. 6d. cloth.

"As a really handy book for reference, we know of no work equal to it; and the railway engineers and others employed in the measurement and calculation of earthwork will find a great amount of practical information very admirably arranged, and available for general or rough estimates, as well as for the more exact calculations required in the engineers' contractor's offices."—*Artizan*.

### *Drawing for Engineers.*

THE WORKMAN'S MANUAL OF ENGINEERING DRAWING. By JOHN MAXTON, Instructor in Engineering Drawing, Royal Naval College, Greenwich, formerly of R. S. N. A., South Kensington. Fifth Edition, carefully revised. With upwards of 300 Plates and Diagrams. 12mo, cloth, strongly bound, 4s.

"A copy of it should be kept for reference in every drawing office."—*Engineering*.

"Indispensable for teachers of engineering drawing."—*Mechanics' Magazine*.

### *Weale's Dictionary of Terms.*

A DICTIONARY of TERMS used in ARCHITECTURE, BUILDING, ENGINEERING, MINING, METALLURGY, ARCHÆOLOGY, the FINE ARTS, &c. By JOHN WEALE. Fifth Edition, revised by ROBERT HUNT, F.R.S., Keeper of Mining Records, Editor of "Ure's Dictionary of Arts." 12mo, 6s. cl. bds.

"The best small technological dictionary in the language."—*Architect*.

"The absolute accuracy of a work of this character can only be judged of after extensive consultation, and from our examination it appears very correct and very complete."—*Mining Journal*.

## MINING, METALLURGY, ETC.

### *Metalliferous Mining.*

BRITISH MINING. A Treatise on the History, Discovery, Practical Development, and Future Prospects of Metalliferous Mines in the United Kingdom. By ROBERT HUNT, F.R.S., Keeper of Mining Records; Editor of "Ure's Dictionary of Arts, Manufactures, and Mines," &c. Upwards of 950 pages, with 230 Illustrations. Super royal 8vo. £3 3s. cloth. [*Just published.*]

"A sound, business-like collection of interesting facts. . . . The amount of information Mr. Hunt has brought together is enormous. . . . The volume appears likely to convey more instruction upon the subject than any work hitherto published."—*Mining Journal.*

### *Coal and Iron.*

THE COAL AND IRON INDUSTRIES OF THE UNITED KINGDOM: comprising a Description of the Coal Fields, and of the Principal Seams of Coal, with returns of their Produce and its Distribution, and Analyses of Special Varieties. Also, an Account of the occurrence of Iron Ores in Veins or Seams; Analyses of each Variety; and a History of the Rise and Progress of Pig Iron Manufacture since the year 1740, exhibiting the economies introduced in the Blast Furnaces for its Production and Improvement. By RICHARD MEADE, Assistant Keeper of Mining Records. With Maps of the Coal Fields and Ironstone Deposits of the United Kingdom. 8vo., £1 8s. cloth.

### *Metalliferous Minerals and Mining.*

A TREATISE ON METALLIFEROUS MINERALS AND MINING. By D. C. DAVIES, F.G.S. With Numerous Wood Engravings. Second Edition, revised. Cr. 8vo, 12s. 6d. cloth.

"Without question, the most exhaustive and the most practically useful work we have seen; the amount of information given is enormous, and it is given concisely and intelligibly."—*Mining Journal.*

### *Earthy Minerals and Mining.*

EARTHY AND OTHER MINERALS, AND MINING. By D. C. DAVIES, F.G.S. Uniform with, and forming a companion volume to, the same Author's "Metalliferous Minerals and Mining." With numerous Illustrations. [*Nearly ready.*]

### *Slate and Slate Quarrying.*

A TREATISE ON SLATE AND SLATE QUARRYING, Scientific, Practical, and Commercial. By D. C. DAVIES, F.G.S. Illustrated. Second Edition, revised. 3s. 6d. cloth.

### *Metallurgy of Iron.*

A TREATISE ON THE METALLURGY OF IRON: containing Outlines of the History of Iron Manufacture, Methods of Assay, and Analyses of Iron Ores, Processes of Manufacture of Iron and Steel, &c. By H. BAUERMAN, F.G.S. Fifth Edition, Revised and Enlarged. Illustrated. 5s. 6d., cloth.

*Mining, Surveying and Valuing.*

THE MINERAL SURVEYOR AND VALUER'S COMPLETE GUIDE, comprising a Treatise on Improved Mining Surveying, with new Traverse Tables; and Descriptions of Improved Instruments; also an Exposition of the Correct Principles of Laying out and Valuing Home and Foreign Iron and Coal Mineral Properties. By WILLIAM LINTERN, Mining and Civil Engineer. With four Plates of Diagrams, Plans, &c. 12mo, 4s. cloth.

\* \* \* Also, bound with THOMAN'S TABLES. 7s. 6d. (See page 20.)

*Coal and Coal Mining.*

COAL AND COAL MINING. By WARINGTON W. SMYTH, M.A., F.R.S., &c., Chief Inspector of the Mines of the Crown. Fifth edition, revised. 4s. cloth.

"Every portion of the volume appears to have been prepared with much care, and as an outline is given of every known coal-field in this and other countries, as well as of the two principal methods of working, the book will doubtless interest a very large number of readers."—*Mining Journal*.

*Underground Pumping Machinery.*

MINE DRAINAGE; being a Complete and Practical Treatise on Direct-Acting Underground Steam Pumping Machinery, with a Description of a large number of the best known Engines, their General Utility and the Special Sphere of their Action, the Mode of their Application, and their merits compared with other forms of Pumping Machinery. By STEPHEN MICHELL. 8vo, 15s. cloth.

*Manual of Mining Tools.*

MINING TOOLS. By W. MORGANS. Text, 12mo, 3s. Atlas of 235 Illustrations, 4to, 6s. Together, 9s. cloth.

---

NAVAL ARCHITECTURE, NAVIGATION, ETC.

*Pocket Book for Naval Architects & Shipbuilders.*

THE NAVAL ARCHITECT'S AND SHIPBUILDER'S POCKET BOOK OF FORMULÆ, RULES, AND TABLES AND MARINE ENGINEER'S AND SURVEYOR'S HANDY BOOK OF REFERENCE. By CLEMENT MACKROW, M. Inst. N. A., Naval Draughtsman. Second Edition, revised. With numerous Diagrams. Fcap., 12s. 6d., strongly bound in leather.

"Should be used by all who are engaged in the construction or design of vessels."—*Engineer*.

"Mr. Mackrow has compressed an extraordinary amount of information into this useful volume."—*Athenæum*.

*Pocket-Book for Marine Engineers.*

A POCKET-BOOK OF USEFUL TABLES AND FORMULÆ FOR MARINE ENGINEERS. By FRANK PROCTOR, A.I.N.A. Third Edition. Royal 32mo, leather, gilt edges, 4s.

"A most useful companion to all marine engineers."—*United Service Gazette*.

"Scarcely anything required by a naval engineer appears to have been forgotten."—*Iron*.

*Grantham's Iron Ship-Building.*

ON IRON SHIP-BUILDING; with Practical Examples and Details. By JOHN GRANTHAM, M. Inst. C.E., &c. Fifth Edition. 40 Plates. Imp. 4to, bds., with separate Text, 2*l.* 2*s.* complete.

*Light-Houses.*

EUROPEAN LIGHT-HOUSE SYSTEMS; being a Report of a Tour of Inspection made in 1873. By Major GEORGE H. ELLIOT, Corps of Engineers, U.S.A. Illustrated by 51 Engravings and 31 Woodcuts in the Text. 8vo, 2*l.* cloth.

*Storms.*

STORMS: their Nature, Classification, and Laws, with the Means of Predicting them by their Embodiments, the Clouds. By WILLIAM BLASIUS. Crown 8vo, 10*s.* 6*d.* cloth boards.

*Rudimentary Navigation.*

THE SAILOR'S SEA-BOOK: a Rudimentary Treatise on Navigation. By JAMES GREENWOOD, B.A. New and enlarged edition. By W. H. ROSSER. 12mo, 3*s.* cloth boards.

*Mathematical and Nautical Tables.*

MATHEMATICAL TABLES, for Trigonometrical, Astronomical, and Nautical Calculations; to which is prefixed a Treatise on Logarithms. By HENRY LAW, C.E. Together with a Series of Tables for Navigation and Nautical Astronomy. By Professor J. R. YOUNG. New Edition. 12mo, 4*s.* cloth boards.

*Navigation (Practical), with Tables.*

PRACTICAL NAVIGATION: consisting of the Sailor's Sea-Book, by JAMES GREENWOOD and W. H. ROSSER; together with the requisite Mathematical and Nautical Tables for the Working of the Problems. By HENRY LAW, C.E., and Professor J. R. YOUNG. Illustrated. 12mo, 7*s.* strongly half-bound in leather.

**WEALE'S RUDIMENTARY SERIES.**

*The following books in Naval Architecture, etc., are published in the above series.*

- NAVIGATION AND NAUTICAL ASTRONOMY IN THEORY AND PRACTICE. By Professor J. R. YOUNG. New Edition. Including the Requisite Elements from the Nautical Almanac for Working the Problems. 12mo, 2*s.* 6*d.* cloth.
- MASTING, MAST-MAKING, AND RIGGING OF SHIPS. By ROBERT KIPPING, N.A. Fifteenth Edition. 12mo, 2*s.* 6*d.* cloth.
- SAILS AND SAIL-MAKING. Tenth Edition, enlarged. By ROBERT KIPPING, N.A. Illustrated. 12mo, 3*s.* cloth boards.
- NAVAL ARCHITECTURE. By JAMES PEAKE. Fifth Edition, with Plates and Diagrams. 12mo, 4*s.* cloth boards.
- MARINE ENGINES, AND STEAM VESSELS. By ROBERT MURRAY, C.E. Eighth Edition. [In preparation.]

## ARCHITECTURE, BUILDING, ETC.

### *Construction.*

THE SCIENCE of BUILDING: An Elementary Treatise on the Principles of Construction. By E. WYNDHAM TARN, M.A. Second Edition, revised, with 58 Engravings, price 7s. 6d.

"A very valuable book, which we strongly recommend to all students."—*Builder*.

"No architectural student should be without this hand-book."—*Architect*.

### *Civil and Ecclesiastical Building.*

A BOOK ON BUILDING, CIVIL AND ECCLESIASTICAL, including CHURCH RESTORATION. By Sir EDMUND BECKETT, Bart., LL.D., Q.C., F.R.A.S. 12mo, 5s. cloth boards.

"A book which is always amusing and nearly always instructive. We are able very cordially to recommend all persons to read it for themselves."—*Times*.

### *Villa Architecture.*

A HANDY BOOK of VILLA ARCHITECTURE; being a Series of Designs for Villa Residences in various Styles. With Outline Specifications and Estimates. By C. WICKES, Architect. 30 Plates, 4to, half morocco, gilt edges, 1l. 1s.

\* \* An Enlarged Edition, with 61 Plates. 2l. 2s. half morocco.

### *Useful Text-Book for Architects.*

THE ARCHITECT'S GUIDE: A Text-book for Architects, Clerks of Works, &c. By F. ROGERS. Cr. 8vo, 6s.

### *The Young Architect's Book.*

HINTS TO YOUNG ARCHITECTS. By G. WIGHTWICK. New Edition. By G. H. GUILLAUME. 12mo, cloth, 4s.

"Will be found an acquisition to pupils, and a copy ought to be considered as necessary a purchase as a box of instruments."—*Architect*.

### *Drawing for Builders and Students.*

PRACTICAL RULES ON DRAWING for the OPERATIVE BUILDER and YOUNG STUDENT in ARCHITECTURE. By GEORGE PYNE. With 14 Plates, 4to, 7s. 6d. boards.

### *Boiler and Factory Chimneys.*

BOILER AND FACTORY CHIMNEYS; their Draught-power and Stability, with a chapter on Lightning Conductors. By ROBERT WILSON, C.E. Crown 8vo, 3s. 6d. cloth.

### *Builder's and Contractor's Price Book.*

LOCKWOOD & CO.'S BUILDER'S AND CONTRACTOR'S PRICE BOOK, containing the latest prices of all kinds of Builders' Materials and Labour, &c. Revised by F. T. W. MILLER, A.R.I.B.A. Half-bound, 4s.

### *Stone-working Machinery.*

STONE-WORKING MACHINERY, and the Rapid and Economical Conversion of Stone. With Hints on the Arrangement and Management of Stone Works. By M. POWIS BALE, M.I.M.E., A.M.I.C.E. [Nearly ready.]

*Taylor and Cresy's Rome.*

THE ARCHITECTURAL ANTIQUITIES OF ROME. By the late G. L. TAYLOR, Esq., F.S.A., and EDWARD CRESY, Esq. New Edition, Edited by the Rev. ALEXANDER TAYLOR, M.A. (son of the late G. L. Taylor, Esq.) This is the only book which gives on a large scale, and with the precision of architectural measurement, the principal Monuments of Ancient Rome in plan, elevation, and detail. Large folio, with 130 Plates, half-bound, 3*l.* 3*s.*

\* \* Originally published in two volumes, folio, at 18*l.* 18*s.*

*Vitruvius' Architecture.*

THE ARCHITECTURE OF MARCUS VITRUVIUS POLLIO. Translated by JOSEPH GWILT, F.S.A., F.R.A.S. Numerous Plates. 12mo, cloth limp, 5*s.*

*Ancient Architecture.*

RUDIMENTARY ARCHITECTURE (ANCIENT); comprising VITRUVIUS, translated by JOSEPH GWILT, F.S.A., &c., with 23 fine plates; and GRECIAN ARCHITECTURE. By the EARL of ABERDEEN; 12mo, 6*s.*, half-bound.

\* \* \* *The only edition of VITRUVIUS procurable at a moderate price.*

*Modern Architecture.*

RUDIMENTARY ARCHITECTURE (MODERN); comprising THE ORDERS OF ARCHITECTURE. By W. H. LEEDS, Esq.; The STYLES of ARCHITECTURE of VARIOUS COUNTRIES. By T. TALBOT BURY; and The PRINCIPLES of DESIGN in ARCHITECTURE. By E. L. GARBETT. Numerous illustrations, 12mo, 6*s.* half-bound.

*Civil Architecture.*

THE DECORATIVE PART of CIVIL ARCHITECTURE. By Sir WILLIAM CHAMBERS, F.R.S. With Illustrations, Notes, and an Examination of Grecian Architecture. By JOSEPH GWILT, F.S.A. Edited by W. H. LEEDS. 66 Plates, 4to, 21*s.*

*House Painting.*

HOUSE PAINTING, GRAINING, MARBLING, AND SIGN WRITING: a Practical Manual of. With 9 Coloured Plates of Woods and Marbles, and nearly 150 Wood Engravings. By ELLIS A. DAVIDSON. Third Edition, Revised. 12mo, 6*s.* cloth.

*Plumbing.*

PLUMBING; a Text-book to the Practice of the Art or Craft of the Plumber. With chapters upon House-drainage, embodying the latest Improvements. By W. P. BUCHAN, Sanitary Engineer. Fourth Edition, Revised, with 330 illustrations. 12mo. 4*s.* cloth.

*Joints used in Building, Engineering, &c.*

THE JOINTS MADE AND USED BY BUILDERS in the construction of various kinds of Engineering and Architectural works, with especial reference to those wrought by artificers in erecting and finishing Habitable Structures. By W. J. CHRISTY, Architect. With 160 Illustrations. 12mo, 3*s.* 6*d.* cloth boards.

*Handbook of Specifications.*

THE HANDBOOK OF SPECIFICATIONS ; or, Practical Guide to the Architect, Engineer, Surveyor, and Builder, in drawing up Specifications and Contracts for Works and Constructions. Illustrated by Precedents of Buildings actually executed by eminent Architects and Engineers. By Professor THOMAS L. DONALDSON, M.I.B.A. New Edition; in One large volume, 8vo, with upwards of 1000 pages of text, and 33 Plates, cloth, 1*l.* 11*s.* 6*d.*

"In this work forty-four specifications of executed works are given. . . . Donaldson's Handbook of Specifications must be bought by all architects."—*Builder.*

*Specifications for Practical Architecture.*

SPECIFICATIONS FOR PRACTICAL ARCHITECTURE: A Guide to the Architect, Engineer, Surveyor, and Builder ; with an Essay on the Structure and Science of Modern Buildings. By FREDERICK ROGERS, Architect. 8vo, 15*s.* cloth.

\* \* A volume of specifications of a practical character being greatly required, and the old standard work of Alfred Bartholomew being out of print, the author, on the basis of that work, has produced the above.—*Extract from Preface.*

*Designing, Measuring, and Valuing.*

THE STUDENT'S GUIDE to the PRACTICE of MEASURING and VALUING ARTIFICERS' WORKS ; containing Directions for taking Dimensions, Abstracting the same, and bringing the Quantities into Bill, with Tables of Constants, and copious Memoranda for the Valuation of Labour and Materials in the respective Trades of Bricklayer and Slater, Carpenter and Joiner, Painter and Glazier, Paperhanger, &c. With 8 Plates and 63 Woodcuts. Originally edited by EDWARD DOBSON, Architect. Fifth Edition, Revised, with considerable Additions on Mensuration and Construction, and a new chapter on Dilapidations, Repairs, and Contracts. By E. WYNDHAM TARN, M.A. 9*s.* [*Just published.*]

"The most complete treatise on the principles of measuring and valuing artificers work that has yet been published."—*Building News.*

*Beaton's Pocket Estimator.*

THE POCKET ESTIMATOR FOR THE BUILDING TRADES, being an easy method of estimating the various parts of a Building collectively, more especially applied to Carpenters' and Joiners' work. By A. C. BEATON. Second Edition. Waistcoat-pocket size. 1*s.* 6*d.*

*Beaton's Builders' and Surveyors' Technical Guide.*

THE POCKET TECHNICAL GUIDE AND MEASURER FOR BUILDERS AND SURVEYORS: containing an Explanation of the Terms used in Building Construction, Directions for Measuring Work, Useful Memoranda, &c. By A. C. BEATON. 1*s.* 6*d.*

*The House-Owner's Estimator.*

THE HOUSE-OWNER'S ESTIMATOR ; or, What will it Cost to Build, Alter, or Repair? A Price-Book for Unprofessional People, Architectural Surveyors, Builders, &c. By the late JAMES D. SIMON. Edited by F. T. W. MILLER, A.R.I.B.A. Third Edition, Revised. Crown 8vo, 3*s.* 6*d.*, cloth.

"In two years it will repay its cost a hundred times over."—*Field.*



## CARPENTRY, TIMBER, ETC.

### *Tredgold's Carpentry, new and cheaper Edition.*

THE ELEMENTARY PRINCIPLES OF CARPENTRY : a Treatise on the Pressure and Equilibrium of Timber Framing, the Resistance of Timber, and the Construction of Floors, Arches, Bridges, Roofs, Uniting Iron and Stone with Timber, &c. To which is added an Essay on the Nature and Properties of Timber, &c., with Descriptions of the Kinds of Wood used in Building ; also numerous Tables of the Scantlings of Timber for different purposes, the Specific Gravities of Materials, &c. By THOMAS TREDGOLD, C.E. Edited by PETER BARLOW, F.R.S. Fifth Edition, corrected and enlarged. With 64 Plates, Portrait of the Author, and Woodcuts. 4to, published at 2*l.* 2*s.*, reduced to 1*l.* 5*s.* cloth.

"A work whose monumental excellence must commend it wherever skilful carpentry is concerned. The Author's principles are rather confirmed than impaired by time. The additional plates are of great intrinsic value."—*Building News*.

### *Grandy's Timber Tables.*

THE TIMBER IMPORTER'S, TIMBER MERCHANT'S, & BUILDER'S STANDARD GUIDE. By R. E. GRANDY. 2nd Edition. Carefully revised and corrected. 12mo, 3*s.* 6*d.* cloth.

"Everything it pretends to be: built up gradually, it leads one from a forest to a treenail, and throws in, as a makeweight, a host of material concerning bricks, columns, cisterns, &c.—all that the class to whom it appeals requires."—*English Mechanic*.

### *Timber Freight Book.*

THE TIMBER IMPORTERS' AND SHIPOWNERS' FREIGHT BOOK : Being a Comprehensive Series of Tables for the Use of Timber Importers, Captains of Ships, Shipbrokers, Builders, and Others. By W. RICHARDSON. Crown 8vo, 6*s.*

### *Tables for Packing-Case Makers.*

PACKING-CASE TABLES ; showing the number of Superficial Feet in Boxes or Packing-Cases, from six inches square and upwards. By W. RICHARDSON. Oblong 4to, 3*s.* 6*d.* cloth.

"Invaluable labour-saving tables."—*Ironmonger*.

### *Carriage Building, &c.*

COACH BUILDING: A Practical Treatise, Historical and Descriptive, containing full information of the various Trades and Processes involved, with Hints on the proper keeping of Carriages, &c. 57 Illustrations. By JAMES W. BURGESS. 12mo, 3*s.* cloth.

### *Horton's Measurer.*

THE COMPLETE MEASURER ; setting forth the Measurement of Boards, Glass, &c. ; Unequal-sided, Square-sided, Octagonal-sided, Round Timber and Stone, and Standing Timber. Also a Table showing the solidity of hewn or eight-sided timber, or of any octagonal-sided column. By RICHARD HORTON. Fourth Edit. With Additions, 12mo, strongly bound in leather, 5*s.*

### *Horton's Underwood and Woodland Tables.*

TABLES FOR PLANTING AND VALUING UNDERWOOD AND WOODLAND ; also Lineal, Superficial, Cubical, and Decimal Tables, &c. By R. HORTON. 12mo, 2*s.* leather.

*Nicholson's Carpenter's Guide.*

THE CARPENTER'S NEW GUIDE; or, BOOK of LINES for CARPENTERS: comprising all the Elementary Principles essential for acquiring a knowledge of Carpentry. Founded on the late PETER NICHOLSON'S standard work. A new Edition, revised by ARTHUR ASHPITEL, F.S.A., together with Practical Rules on Drawing, by GEORGE PYNE. With 74 Plates, 4to, 17. 1s. cloth.

*Dowsing's Timber Merchant's Companion.*

THE TIMBER MERCHANT'S AND BUILDER'S COMPANION; containing New and Copious Tables of the Reduced Weight and Measurement of Deals and Battens, of all sizes, from One to a Thousand Pieces, also the relative Price that each size bears per Lineal Foot to any given Price per Petersburg Standard Hundred, &c., &c. Also a variety of other valuable information. By W. DOWSING. Third Edition. Crown 8vo, 3s.

*Practical Timber Merchant.*

THE PRACTICAL TIMBER MERCHANT, being a Guide for the use of Building Contractors, Surveyors, Builders, &c., comprising useful Tables for all purposes connected with the Timber Trade, Essay on the Strength of Timber, Remarks on the Growth of Timber, &c. By W. RICHARDSON. Fcap. 8vo, 3s. 6d. cl.

*Woodworking Machinery.*

WOODWORKING MACHINERY; its Rise, Progress, and Construction. With Hints on the Management of Saw Mills and the Economical Conversion of Timber. Illustrated with Examples of Recent Designs by leading English, French, and American Engineers. By M. POWIS BALE, M.I.M.E. Crown 8vo, 12s. 6d. cl.

"Mr. Bale is evidently an expert on the subject, and he has collected so much information that his book is all-sufficient for builders and others engaged in the conversion of timber."—*Architect.*

"The most comprehensive compendium of wood-working machinery we have seen. The author is a thorough master of his subject."—*Building News.*

*Saw Mills.*

SAW MILLS, THEIR ARRANGEMENT AND MANAGEMENT, AND THE ECONOMICAL CONVERSION OF TIMBER. (Being a Companion Volume to "Woodworking Machinery.") By M. POWIS BALE, M.I.M.E. With numerous Illustrations. Crown 8vo, 10s. 6d., cloth.

"The author is favourably known by his former work on 'Woodworking Machinery,' of which we were able to speak approvingly. This is a companion volume, in which the *administration* of a large sawing establishment is discussed, and the subject examined from a financial standpoint. Hence the size, shape, order, and disposition of saw-mills and the like are gone into in detail, and the course of the timber is traced from its reception to its delivery in its converted state. We could not desire a more complete or practical treatise."—*Builder.*

"We highly recommend Mr. Bale's work to the attention and perusal of all those who are engaged in the art of wood conversion, or who are about building or re-modelling saw-mills on improved principles."—*Building News.*

"Will be found of much value by that special class of readers for whose information it is designed. We have pleasure in recommending the book to those about to construct or to manage saw-mills."—*Athenæum.*

## MECHANICS, ETC.

*Engineer's Reference Book.*

THE WORKS MANAGERS' HANDBOOK. For Engineers, Millwrights, and Boiler Makers; Tool Makers, Machinists, and Metal Workers; Iron and Brassfounders, &c. By W. S. HUTTON, Civil and Mechanical Engineer. Medium 8vo, about 400 pages, price 12s. 6d., strongly bound. [In preparation.]

*Mechanic's Workshop Companion.*

THE OPERATIVE MECHANIC'S WORKSHOP COMPANION, and THE SCIENTIFIC GENTLEMAN'S PRACTICAL ASSISTANT. By W. TEMPLETON. 13th Edit., with Mechanical Tables for Operative Smiths, Millwrights, Engineers, &c.; and an Extensive Table of Powers and Roots, 12mo, 5s. bound.

"Admirably adapted to the wants of a very large class. It has met with great success in the engineering workshop, as we can testify; and there are a great many men who, in a great measure, owe their rise in life to this little work."—*Building News*.

*Engineer's and Machinist's Assistant.*

THE ENGINEER'S, MILLWRIGHT'S, and MACHINIST'S PRACTICAL ASSISTANT; comprising a Collection of Useful Tables, Rules, and Data. By WM. TEMPLETON. 18mo, 2s. 6d.

*Smith's Tables for Mechanics, &c.*

TABLES, MEMORANDA, and CALCULATED RESULTS, FOR MECHANICS, ENGINEERS, ARCHITECTS, BUILDERS, &c. Selected and arranged by FRANCIS SMITH. 240 pp. Waistcoat-pocket size, 1s. 6d., limp leather.

*Turning.*

LATHE-WORK: a Practical Treatise on the Tools, Appliances, and Processes employed in the Art of Turning. By PAUL N. HASLUCK. Second Edition, thoroughly Revised, with a New Chapter on the Screw-cutting Lathe. Crown 8vo, 5s. cloth.

*Turning.*

THE METAL TURNER'S HANDBOOK. By PAUL N. HASLUCK. With over 100 Cuts. Crown 8vo, 1s., cloth.

\* \* \* The above forms the first volume of HASLUCK'S HANDBOOKS ON HANDICRAFTS. Other Volumes in preparation.

*Boiler Making.*

THE BOILER-MAKER'S READY RECKONER. With Examples of Practical Geometry and Templating, for the use of Platers, Smiths, and Riveters. By JOHN COURTNEY, Edited by D. K. CLARK, M.I.C.E. 12mo, 9s., half-bd.

*Superficial Measurement.*

THE TRADESMAN'S GUIDE TO SUPERFICIAL MEASUREMENT. Tables calculated from 1 to 200 inches in length, by 1 to 108 inches in breadth. By J. HAWKINGS. Fcp. 3s. 6d. cl.

*Steam Boilers.*

A TREATISE ON STEAM BOILERS: their Strength, Construction, and Economical Working. By R. WILSON, C.E. Fifth Edition. 12mo, 6s., cloth.

[The best treatise that has ever been published on steam boilers.]—*Engineer*.

MATHEMATICS, TABLES, ETC.

*Metrical Units and Systems, &c.*

MODERN METROLOGY: A Manual of the Metrical Units and Systems of the present Century. With an Appendix containing a proposed English System. By **LOWIS D'A. JACKSON**, A.-M. Inst. C.E., Author of "Aid to Survey Practice," &c. Large Crown 8vo, 12s. 6d. cloth.

*Gregory's Practical Mathematics.*

MATHEMATICS for PRACTICAL MEN; being a Common-place Book of Pure and Mixed Mathematics. Designed chiefly for the use of Civil Engineers, Architects, and Surveyors. Part I. PURE MATHEMATICS—comprising Arithmetic, Algebra, Geometry, Mensuration, Trigonometry, Conic Sections, Properties of Curves. Part II. MIXED MATHEMATICS—comprising Mechanics in general, Statics, Dynamics, Hydrostatics, Hydrodynamics, Pneumatics, Mechanical Agents, Strength of Materials, &c. By **OLINTHUS GREGORY**, LL.D., F.R.A.S. Enlarged by **H. LAW**, C.E. 4th Edition, revised by **Prof. J. R. YOUNG**. With 13 Plates. 8vo. 1l. 1s. cloth.

*Mathematics as applied to the Constructive Arts.*

A TREATISE ON MATHEMATICS AS APPLIED TO THE CONSTRUCTIVE ARTS. Illustrating the various processes of Mathematical Investigation by means of Arithmetical and simple Algebraical Equations and Practical Examples, &c. By **FRANCIS CAMPIN**, C.E. 12mo, 3s. 6d. cloth.

*Geometry for the Architect, Engineer, &c.*

PRACTICAL GEOMETRY, for the Architect, Engineer, and Mechanic. By **E. W. TARN**, M.A. With Appendices on Diagrams of Strains and Isometrical projection. Demy 8vo, 9s. cloth.

*Practical Geometry.*

THE GEOMETRY OF COMPASSES, or Problems Resolved by the Mere Description of Circles, and the Use of Coloured Diagrams and Symbols. By **OLIVER BYRNE**. Coloured Plates. Crown 8vo, 3s. 6d. cloth.

*The Metric System.*

A SERIES OF METRIC TABLES, in which the British Standard Measures and Weights are compared with those of the Metric System at present in use on the Continent. By **C. H. DOWLING**, C.E. 2nd Edit., revised and enlarged. 8vo, 10s. 6d. cl.

*Inwood's Tables, greatly enlarged and improved.*

TABLES FOR THE PURCHASING of ESTATES, Freehold, Copyhold, or Leasehold; Annuities, Advowsons, &c., and for the Renewing of Leases; also for Valuing Reversionary Estates, Deferred Annuities, &c. By **WILLIAM INWOOD**. 22nd Edition, with Tables of Logarithms for the more Difficult Computations of the Interest of Money, &c. By **M. FEDOR THOMAN**. 12mo. 8s. cloth.

"Those interested in the purchase and sale of estates, and in the adjustment of compensation cases, as well as in transactions in annuities, life insurances, &c., will find the present edition of eminent service."—*Engineering*.

*Weights, Measures, and Moneys.*

MEASURES, WEIGHTS, and MONEYS of all NATIONS, Entirely New Edition, Revised and Enlarged. By W. S. B. WOOLHOUSE, F.R.A.S. 12mo, 2s. 6d. cloth boards.

*Compound Interest and Annuities.*

THEORY of COMPOUND INTEREST and ANNUITIES; with Tables of Logarithms for the more Difficult Computations of Interest, Discount, Annuities, &c., in all their Applications and Uses for Mercantile and State Purposes. By FÉDOR THOMAN, of the Société Crédit Mobilier, Paris. 3rd Edit., 12mo, 4s. 6d. cl.

*Iron and Metal Trades' Calculator.*

THE IRON AND METAL TRADES' COMPANION: Being a Calculator containing a Series of Tables upon a new and comprehensive plan for expeditiously ascertaining the value of any goods bought or sold by weight, from 1s. per cwt. to 112s. per cwt., and from one farthing per lb. to 1s. per lb. Each Table extends from one lb. to 100 tons. By T. DOWNIE. 396 pp., 9s., leather.

*Iron and Steel.*

IRON AND STEEL: a Work for the Forge, Foundry, Factory, and Office. Containing Information for Ironmasters; Civil, Mechanical, and Mining Engineers; Architects, Builders, &c. By CHARLES HOARE. Eighth Edit. Oblong 32mo, 6s., leather.

*Comprehensive Weight Calculator.*

THE WEIGHT CALCULATOR, being a Series of Tables upon a New and Comprehensive Plan, exhibiting at one Reference the exact Value of any Weight from 1 lb. to 15 tons, at 300 Progressive Rates, from 1 Penny to 168 Shillings per cwt., and containing 186,000 Direct Answers, which, with their Combinations, consisting of a single addition, will afford an aggregate of 10,266,000 Answers; the whole being calculated and designed to ensure Correctness and promote Despatch. By HENRY HARBEN, Accountant. New Edition. Royal 8vo, 1l. 5s., half-bound.

*Comprehensive Discount Guide.*

THE DISCOUNT GUIDE: comprising Tables for the use of Merchants, Manufacturers, Ironmongers, and others, by which may be ascertained the exact profit arising from any mode of using Discounts, either in the Purchase or Sale of Goods, and the method of either Altering a Rate of Discount, or Advancing a Price, so as to produce, by one operation, a sum that will realise any required profit after allowing one or more Discounts: to which are added Tables of Profit or Advance from  $1\frac{1}{4}$  to 90 per cent., Tables of Discount from  $1\frac{1}{4}$  to  $98\frac{3}{4}$  per cent., and Tables of Commission, &c., from  $\frac{1}{8}$  to 10 per cent. By H. HARBEN, 8vo, 1l. 5s., half-bound.

*Mathematical Instruments.*

MATHEMATICAL INSTRUMENTS: Their Construction, Adjustment, Testing, and Use; comprising Drawing, Measuring, Optical, Surveying, and Astronomical Instruments. By J. F. HEATHER, M.A. Enlarged Edition. 12mo, 5s. cloth.

SCIENCE AND ART.

*Gold and Gold-Working.*

THE GOLDSMITH'S HANDBOOK: containing full instructions for the Alloying and Working of Gold. Including the Art of Alloying, Melting, Reducing, Colouring, Collecting and Refining. Chemical and Physical Properties of Gold, with a new System of Mixing its Alloys; Solders, Enamels, &c. By GEORGE E. GEE. Second Edition, enlarged. 12mo, 3s. 6d. cloth.

"The best work yet printed on its subject for a reasonable price."—*Jeweller.*

"Essentially a practical manual, well adapted to the wants of amateurs and apprentices, containing trustworthy information that only a practical man can supply."—*English Mechanic.*

*Silver and Silver Working.*

THE SILVERSMITH'S HANDBOOK, containing full Instructions for the Alloying and Working of Silver. Including the different Modes of Refining and Melting the Metal, its Solders, the Preparation of Imitation Alloys, &c. By G. E. GEE. 12mo, 3s. 6d.

"The chief merit of the work is its practical character. The workers in the trade will speedily discover its merits when they sit down to study it."—*English Mechanic.*

*Hall-Marking of Jewellery.*

THE HALL-MARKING OF JEWELLERY PRACTICALLY CONSIDERED, comprising an account of all the different Assay Towns of the United Kingdom; with the Stamps at present employed; also the Laws relating to the Standards and Hall-Marks at the various Assay Offices; and a variety of Practical Suggestions concerning the Mixing of Standard Alloys, &c. By GEORGE E. GEE. Crown 8vo, 3s. 6d. cloth.

*Electro-Plating, &c.*

ELECTRO-PLATING: A Practical Handbook. By J. W. URQUHART, C.E. Crown 8vo, 5s. cloth.

"Any ordinarily intelligent person may become an adept in electro-deposition with a very little science indeed, and this is the book to show the way."—*Builder.*

*Electrotyping, &c.*

ELECTROTYPING: The Reproduction and Multiplication of Printing Surfaces and Works of Art by the Electro-deposition of Metals. By J. W. URQUHART, C.E. Crown 8vo, 5s. cloth.

"A guide to beginners and those who practise the old and imperfect methods."—*Iron.*

*Electro-Plating.*

ELECTRO-METALLURGY PRACTICALLY TREATED. BY ALEXANDER WATT, F.R.S.S.A. Including the Electro-Deposition of Copper, Silver, Gold, Brass and Bronze, Platinum, Lead, Nickel, Tin, Zinc, Alloys of Metals, Practical Notes, &c., &c. Eighth Edition, Revised, including the most recent Processes. 12mo, 3s. 6d., cloth.

"From this book both amateur and artisan may learn everything necessary for the successful prosecution of electroplating."—*Iron.*

"A practical treatise for the use of those who desire to work in the art of electro-deposition as a business."—*English Mechanic.*

*Dentistry.*

MECHANICAL DENTISTRY. A Practical Treatise on the Construction of the various kinds of Artificial Dentures. Comprising also Useful Formulæ, Tables, and Receipts for Gold Plate, Clasps, Solders, etc., etc. By CHARLES HUNTER. Second Edition, Revised. With over 100 Engravings. 7s. 6d., cloth.

*Electricity.*

A MANUAL of ELECTRICITY; including Galvanism, Magnetism, Diamagnetism, Electro-Dynamics, Magneto-Electricity, and the Electric Telegraph. By HENRY M. NOAD, Ph.D., F.C.S. Fourth Edition, with 500 Woodcuts. 8vo, 17. 4s. cloth.

"The accounts given of electricity and galvanism are not only complete in a scientific sense, but, which is a rarer thing, are popular and interesting."—*Lancet*.

*Text-Book of Electricity.*

THE STUDENT'S TEXT-BOOK OF ELECTRICITY. By HENRY M. NOAD, Ph.D., F.R.S., &c. New Edition, Revised. With an Introduction and Additional Chapters by W. H. PREECE, M.I.C.E., Vice-President of the Society of Telegraph Engineers, &c. With 470 Illustrations. Crown 8vo, 12s. 6d. cloth.

"We can recommend Dr. Noad's book for clear style, great range of subject, a good index, and a plethora of woodcuts."—*Athenæum*.

"An admirable text-book for every student—beginner or advanced—of electricity."—*Engineering*.

"Under the editorial hand of Mr. Preece the late Dr. Noad's text-book of electricity has grown into an admirable handbook."—*Westminster Review*.

*Electric Lighting.*

ELECTRIC LIGHT: Its Production and Use, embodying plain Directions for the Treatment of Voltaic Batteries, Electric Lamps, and Dynamo-Electric Machines. By J. W. URQUHART, C.E. Edited by F. C. WEBB, M.I.C.E., M.S.T.E. 2nd Edition, Revised, with Large Additions and 128 Illustrations. 7s. 6d. cloth.

"The book is by far the best that we have yet met with on the subject."—*Athenæum*.

*Lightning.*

THE ACTION of LIGHTNING, and the MEANS of DEFENDING LIFE AND PROPERTY FROM ITS EFFECTS. By Major ARTHUR PARNELL, R.E. 12mo, 7s. 6d. cloth.

*The Blowpipe.*

THE BLOWPIPE IN CHEMISTRY, MINERALOGY, AND GEOLOGY, containing all known Methods of Anhydrous Analysis, many Working Examples, and Instructions for making Apparatus. By Lieut.-Col. W. A. ROSS, R.A., F.G.S.

[In the press.]

*Chemical Analysis.*

THE COMMERCIAL HANDBOOK of CHEMICAL ANALYSIS; or Practical Instructions for the determination of the Intrinsic or Commercial Value of Substances used in Manufactures, in Trades, and in the Arts. By A. NORMANDY. *New Edition*. Enlarged, and to a great extent re-written, by HENRY M. NOAD, Ph.D., F.R.S. With numerous Illustrations. Cr. 8vo, 12s. 6d. cloth.

## *The Alkali Trade—Sulphuric Acid, &c.*

A MANUAL OF THE ALKALI TRADE, including the Manufacture of Sulphuric Acid, Sulphate of Soda, and Bleaching Powder. By JOHN LOMAS, Alkali Manufacturer. With 232 Illustrations and Working Drawings, and containing 386 pages of text. Super-royal 8vo, 2l. 12s. 6d. cloth.

*This work provides (1) a Complete Handbook for intending Alkali and Sulphuric Acid Manufacturers, and for those already in the field who desire to improve their plant, or to become practically acquainted with the latest processes and developments of the trade; (2) a Handy Volume which Manufacturers can put into the hands of their Managers and Foremen as a useful guide in their daily rounds of duty.*

### SYNOPSIS OF CONTENTS.

Chap. I. Choice of Site and General Plan of Works—II. Sulphuric Acid—III. Recovery of the Nitrogen Compounds, and Treatment of Small Pyrites—IV. The Salt Cake Process—V. Legislation upon the Noxious Vapours Question—VI. The Hargreaves' and Jones' Processes—VII. The Balling Process—VIII. Lixiviation and Salting Down—

IX. Carbonating or Finishing—X. Soda Crystals—XI. Refined Alkali—XII. Caustic Soda—XIII. Bi-carbonate of Soda—XIV. Bleaching Powder—XV. Utilisation of Tank Waste—XVI. General Remarks—Four Appendices, treating of Yields, Sulphuric Acid Calculations, Anemometers, and Foreign Legislation upon the Noxious Vapours Question.

"The author has given the fullest, most practical, and, to all concerned in the alkali trade, most valuable mass of information that, to our knowledge, has been published in any language."—*Engineer*.

"This book is written by a manufacturer for manufacturers. The working details of the most approved forms of apparatus are given, and these are accompanied by no less than 232 wood engravings, all of which may be used for the purposes of construction. Every step in the manufacture is very fully described in this manual, and each improvement explained. Everything which tends to introduce economy into the technical details of this trade receives the fullest attention."—*Athenæum*.

"The author is not one of those clever compilers who, on short notice, will 'read up' any conceivable subject, but a practical man in the best sense of the word. We find here not merely a sound and luminous explanation of the chemical principles of the trade, but a notice of numerous matters which have a most important bearing on the successful conduct of alkali works, but which are generally overlooked by even the most experienced technological authors."—*Chemical Review*.

## *Soap-making.*

THE ART OF SOAP-MAKING, A Practical Handbook of the Manufacture of Hard and Soft Soaps, Toilet Soaps, &c. Including many New Processes, and a Chapter on the Recovery of Glycerine from Waste Leys. By ALEXANDER WATT, Author of "Electro-Metallurgy Practically Treated," &c. With Numerous Illustrations. Crown 8vo, 9s., cloth. [Just published.]

"The work will prove very useful, not merely to the technological student, but to the practical soap-boiler who wishes to understand the theory of his art."—*Chemical News*.

"Every stage of the process of the manufacture of the various kinds of soap is clearly described."—*The Textile Recorder*.

## *Leather Manufacture.*

THE ART OF LEATHER MANUFACTURE. Being a Practical Handbook in which the Operations of Tanning, Currying, and Leather Dressing are fully Described, and the Principles of Tanning Explained, with Practical Details, and Accounts of many Recent Processes, to which is added a Description of the Arts of Glue Manufacture, Gut Dressing, &c. By ALEXANDER WATT, Author of "Soap-Making," "Electro-Metallurgy," &c. With numerous Illustrations. Crown 8vo. [In preparation.]



*Dr. Lardner's Museum of Science and Art.*

THE MUSEUM OF SCIENCE AND ART. Edited by DIONYSIUS LARDNER, D.C.L., formerly Professor of Natural Philosophy and Astronomy in University College, London. With upwards of 1200 Engravings on Wood. In 6 Double Volumes. Price £1 1s., in a new and elegant cloth binding, or handsomely bound in half morocco, 31s. 6d.

## OPINIONS OF THE PRESS.

"This series, besides affording popular but sound instruction on scientific subjects, with which the humblest man in the country ought to be acquainted, also undertakes that teaching of 'common things' which every well-wisher of his kind is anxious to promote. Many thousand copies of this serviceable publication have been printed, in the belief and hope that the desire for instruction and improvement widely prevails; and we have no fear that such enlightened faith will meet with disappointment."—*Times*.

"A cheap and interesting publication, alike informing and attractive. The papers combine subjects of importance and great scientific knowledge, considerable inductive powers, and a popular style of treatment."—*Spectator*.

"The 'Museum of Science and Art' is the most valuable contribution that has ever been made to the Scientific Instruction of every class of society."—*Sir David Brewster in the North British Review*.

"Whether we consider the liberality and beauty of the illustrations, the charm of the writing, or the durable interest of the matter, we must express our belief that there is hardly to be found among the new books, one that would be welcomed by people of so many ages and classes as a valuable present."—*Examiner*.

\* \* *Separate books formed from the above, suitable for Workmen's Libraries, Science Classes, &c.*

COMMON THINGS EXPLAINED. Containing Air, Earth, Fire, Water, Time, Man, the Eye, Locomotion, Colour, Clocks and Watches, &c. 233 Illustrations, cloth gilt, 5s.

THE MICROSCOPE. Containing Optical Images, Magnifying Glasses, Origin and Description of the Microscope, Microscopic Objects, the Solar Microscope, Microscopic Drawing and Engraving, &c. 147 Illustrations, cloth gilt, 2s.

POPULAR GEOLOGY. Containing Earthquakes and Volcanoes, the Crust of the Earth, etc. 201 Illustrations, cloth gilt, 2s. 6d.

POPULAR PHYSICS. Containing Magnitude and Minuteness, the Atmosphere, Meteoric Stones, Popular Fallacies, Weather Prognostics, the Thermometer, the Barometer, Sound, &c. 85 Illustrations, cloth gilt, 2s. 6d.

STEAM AND ITS USES. Including the Steam Engine, the Locomotive, and Steam Navigation. 89 Illustrations, cloth gilt, 2s.

POPULAR ASTRONOMY. Containing How to Observe the Heavens. The Earth, Sun, Moon, Planets. Light, Comets, Eclipses, Astronomical Influences, &c. 182 Illustrations, 4s. 6d.

THE BEE AND WHITE ANTS: Their Manners and Habits. With Illustrations of Animal Instinct and Intelligence. 135 Illustrations, cloth gilt, 2s.

THE ELECTRIC TELEGRAPH POPULARISED. To render intelligible to all who can Read, irrespective of any previous Scientific Acquirements, the various forms of Telegraphy in Actual Operation. 100 Illustrations, cloth gilt, 1s. 6d.

### *Dr. Lardner's Handbooks of Natural Philosophy.*

\* \* \* The following five volumes, though each is Complete in itself, and to be purchased separately, form A COMPLETE COURSE OF NATURAL PHILOSOPHY, and are intended for the general reader who desires to attain accurate knowledge of the various departments of Physical Science, without pursuing them according to the more profound methods of mathematical investigation. The style is studiously popular. It has been the author's aim to supply Manuals such as are required by the Student, the Engineer, the Artisan, and the superior classes in Schools.

**THE HANDBOOK OF MECHANICS.** Enlarged and almost rewritten by BENJAMIN LOEWY, F.R.A.S. With 378 Illustrations. Post 8vo, 6s. cloth.

"The perspicuity of the original has been retained, and chapters which had become obsolete, have been replaced by others of more modern character. The explanations throughout are studiously popular, and care has been taken to show the application of the various branches of physics to the industrial arts, and to the practical business of life."—*Mining Journal*.

**THE HANDBOOK OF HYDROSTATICS and PNEUMATICS.** New Edition, Revised and Enlarged by BENJAMIN LOEWY, F.R.A.S. With 236 Illustrations. Post 8vo, 5s. cloth.

"For those 'who desire to attain an accurate knowledge of physical science without the profound methods of mathematical investigation,' this work is not merely intended, but well adapted."—*Chemical News*.

**THE HANDBOOK OF HEAT.** Edited and almost entirely Rewritten by BENJAMIN LOEWY, F.R.A.S., etc. 117 Illustrations. Post 8vo, 6s. cloth.

"The style is always clear and precise, and conveys instruction without leaving any cloudiness or lurking doubts behind."—*Engineering*.

**THE HANDBOOK OF OPTICS.** New Edition. Edited by T. OLVER HARDING, B.A. 298 Illustrations. Post 8vo, 5s. cloth.

"Written by one of the ablest English scientific writers, beautifully and elaborately illustrated."—*Mechanics' Magazine*.

**THE HANDBOOK OF ELECTRICITY, MAGNETISM, and ACOUSTICS.** New Edition. Edited by GEO. CAREY FOSTER, B.A., F.C.S. With 400 Illustrations. Post 8vo, 5s. cloth.

"The book could not have been entrusted to any one better calculated to preserve the terse and lucid style of Lardner, while correcting his errors and bringing up his work to the present state of scientific knowledge."—*Popular Science Review*.

### *Dr. Lardner's Handbook of Astronomy.*

**THE HANDBOOK OF ASTRONOMY.** Forming a Companion to the "Handbooks of Natural Philosophy." By DIONYSIUS LARDNER, D.C.L. Fourth Edition. Revised and Edited by EDWIN DUNKIN, F.R.S., Royal Observatory, Greenwich. With 38 Plates and upwards of 100 Woodcuts. In 1 vol., small 8vo, 550 pages, 9s. 6d., cloth.

"Probably no other book contains the same amount of information in so compendious and well-arranged a form—certainly none at the price at which this is offered to the public."—*Athenæum*.

"We can do no other than pronounce this work a most valuable manual of astronomy, and we strongly recommend it to all who wish to acquire a general—but at the same time correct—acquaintance with this sublime science."—*Quarterly Journal of Science*.

### *Dr. Lardner's Handbook of Animal Physics.*

**THE HANDBOOK OF ANIMAL PHYSICS.** By DR. LARDNER. With 520 Illustrations. New Edition, small 8vo, cloth, 732 pages, 7s. 6d.

'We have no hesitation in cordially recommending it.'—*Educational Times*.

*Dr. Lardner's School Handbooks.*

NATURAL PHILOSOPHY FOR SCHOOLS. By DR. LARDNER.  
328 Illustrations. Sixth Edition. 1 vol. 3s. 6d. cloth.

"Conveys, in clear and precise terms, general notions of all the principal divisions of Physical Science."—*British Quarterly Review*.

ANIMAL PHYSIOLOGY FOR SCHOOLS. By DR. LARDNER.  
With 190 Illustrations. Second Edition. 1 vol. 3s. 6d. cloth.

"Clearly written, well arranged, and excellently illustrated."—*Gardeners' Chronicle*.

*Dr. Lardner's Electric Telegraph.*

THE ELECTRIC TELEGRAPH. By DR. LARDNER. New Edition. Revised and Re-written, by E. B. BRIGHT, F.R.A.S.  
140 Illustrations. Small 8vo, 2s. 6d. cloth.

"One of the most readable books extant on the Electric Telegraph."—*Eng. Mechanic*.

*Mollusca.*

A MANUAL OF THE MOLLUSCA; being a Treatise on Recent and Fossil Shells. By Dr. S. P. WOODWARD, A.L.S.  
With Appendix by RALPH TATE, A.L.S., F.G.S. With numerous Plates and 300 Woodcuts. 3rd Edition. Cr. 8vo, 7s. 6d. cloth.

*Geology and Genesis.*

THE TWIN RECORDS OF CREATION; or, Geology and Genesis, their Perfect Harmony and Wonderful Concord. By GEORGE W. VICTOR LE VAUX. Fcap. 8vo, 5s. cloth.

"A valuable contribution to the evidences of revelation, and disposes very conclusively of the arguments of those who would set God's Works against God's Word. No real difficulty is shirked, and no sophistry is left unexposed."—*The Rock*.

*Geology.*

GEOLOGY, PHYSICAL AND HISTORICAL: Consisting of "Physical Geology," which sets forth the Leading Principles of the Science; and "Historical Geology," which treats of the Mineral and Organic Conditions of the Earth at each successive epoch, especial reference being made to the British Series of Rocks. By RALPH TATE. With more than 250 Illustrations. Fcap. 8vo, 5s. cloth.

*Practical Philosophy.*

A SYNOPSIS OF PRACTICAL PHILOSOPHY. By Rev. JOHN CARR, M.A., late Fellow of Trin. Coll., Camb. 18mo, 5s. cl.

*The Military Sciences.*

AIDE-MÉMOIRE to the MILITARY SCIENCES. Framed from Contributions of Officers and others connected with the different Services. Originally edited by a Committee of the Corps of Royal Engineers. 2nd Edition, revised; nearly 350 Engravings and many hundred Woodcuts. 3 vols. royal 8vo, cloth, 4l. 10s.

*Field Fortification.*

A TREATISE ON FIELD FORTIFICATION, the ATTACK OF FORTRESSES, MILITARY MINING, and RECONNOITRING. By Colonel I. S. MACAULAY, late Professor of Fortification in the R. M. A., Woolwich. Sixth Edition, crown 8vo, cloth, with separate Atlas of 12 Plates, 12s. complete.

### *Clocks, Watches, and Bells.*

RUDIMENTARY TREATISE on CLOCKS, and WATCHES, and BELLS. By Sir EDMUND BECKETT, Bart., LL.D., Q.C., F.R.A.S. Seventh Edition, revised and enlarged. Limp cloth (No. 67, Weale's Series), 4s. 6d.; cl. bds. 5s. 6d.

"The best work on the subject extant. The treatise on bells is undoubtedly the best in the language."—*Engineering*.

"The only modern treatise on clock-making."—*Horological Journal*.

### *The Construction of the Organ.*

PRACTICAL ORGAN-BUILDING. By W. E. DICKSON, M.A., Precentor of Ely Cathedral. Second Edition, revised, with Additions. 12mo, 3s. cloth boards.

"The amateur builder will find in this book all that is necessary to enable him personally to construct a perfect organ with his own hands."—*Academy*.

### *Brewing.*

A HANDBOOK FOR YOUNG BREWERS. By HERBERT EDWARDS WRIGHT, B.A. Crown 8vo, 3s. 6d. cloth.

"A thoroughly scientific treatise in popular language."—*Morning Advertiser*.

"We would particularly recommend teachers of the art to place it in every pupil's hands, and we feel sure its perusal will be attended with advantage."—*Brewer*.

### *Dye-Wares and Colours.*

THE MANUAL of COLOURS and DYE-WARES: their Properties, Applications, Valuation, Impurities, and Sophistications. For the Use of Dyers, Printers, Drysalters, Brokers, &c. By J. W. SLATER. Second Edition. Crown 8vo, 7s. 6d. cloth.

"A complete encyclopædia of the materia tinctoria."—*Chemist and Druggist*.

"The newest resources of the dyer and printer are noticed with completeness, accuracy, and clearness."—*Chemical News*.

### *Grammar of Colouring.*

A GRAMMAR OF COLOURING, applied to Decorative Painting and the Arts. By GEORGE FIELD. New Edition. By ELLIS A. DAVIDSON. 12mo, 3s. 6d. cloth.

### *Woods and Marbles (Imitation of).*

SCHOOL OF PAINTING FOR THE IMITATION OF WOODS AND MARBLES, as Taught and Practised by A. R. and P. VAN DER BURG. With 24 full-size Coloured Plates; also 12 Plain Plates, comprising 154 Figures. Folio, 2l. 12s. 6d. bound.

"As patterns the plates are perfect, and by following them a style both artistic and accurate will be obtained. The instructions accompanying the plates are full and explicit, and may be comprehended by the dullest understanding without difficulty. The students and novices are fortunate who are able to become the possessors of *so noble a work*."—*Architect*.

### *Pictures and Painters.*

THE PICTURE AMATEUR'S HANDBOOK AND DICTIONARY OF PAINTERS: A Guide for Visitors to Picture Galleries, and for Art-Students, including methods of Painting, Cleaning, Re-Lining, and Restoring, the Principal Schools of Painting. With Notes on Copyists and Imitators of each Master. By PHILIPPE DARYL, B.A. Cr. 8vo, 3s. cloth.

"A guide to the authorship, quality, and value of a picture, and furnishes the fundamental knowledge necessary to amateurs."—*Saturday Review*.]

*Delamotte's Works on Illumination & Alphabets.*

A PRIMER OF THE ART OF ILLUMINATION; for the use of Beginners: with a Rudimentary Treatise on the Art, Practical Directions for its Exercise, and numerous Examples taken from Illuminated MSS., printed in Gold and Colours. By F. DELAMOTTE. Small 4to, 9s. Elegantly bound, cloth antique.

"The examples of ancient MSS. recommended to the student, which, with much good sense, the author chooses from collections accessible to all, are selected with judgment and knowledge, as well as taste."—*Athenæum*.

ORNAMENTAL ALPHABETS, ANCIENT and MEDIÆVAL; from the Eighth Century, with Numerals; including Gothic, Church-Text, German, Italian, Arabesque, Initials, Monograms, Crosses, &c. Collected and engraved by F. DELAMOTTE, and printed in Colours. Tenth and Cheaper Edition. Royal 8vo, oblong, 2s. 6d. ornamental boards.

"For those who insert enamelled sentences round gilded chalices, who blazon shop legends over shop-doors, who letter church walls with pithy sentences from the Decalogue, this book will be useful."—*Athenæum*.

EXAMPLES OF MODERN ALPHABETS, PLAIN and ORNAMENTAL; including German, Old English, Saxon, Italic, Perspective, Greek, Hebrew, Court Hand, Engrossing, Tuscan, Riband, Gothic, Rustic, and Arabesque, &c., &c. Collected and engraved by F. DELAMOTTE, and printed in Colours. Eighth and Cheaper Edition. Royal 8vo, oblong, 2s. 6d. ornamental boards.

"There is comprised in it every possible shape into which the letters of the alphabet and numerals can be formed."—*Standard*.

MEDIÆVAL ALPHABETS AND INITIALS FOR ILLUMINATORS. By F. DELAMOTTE. Containing 21 Plates, and Illuminated Title, printed in Gold and Colours. With an Introduction by J. WILLIS BROOKS. Small 4to, 6s. cloth gilt.

THE EMBROIDERER'S BOOK OF DESIGN; containing Initials, Emblems, Cyphers, Monograms, Ornamental Borders, Ecclesiastical Devices, Mediæval and Modern Alphabets, and National Emblems. Collected and engraved by F. DELAMOTTE, and printed in Colours. Oblong royal 8vo, 1s. 6d. ornamental wrapper.

*Popular Work on Painting.*

PAINTING POPULARLY EXPLAINED; with Historical Sketches of the Progress of the Art. By THOMAS JOHN GULLICK, Painter, and JOHN TIMBS, F.S.A. Fourth Edition, revised and enlarged. With Frontispiece and Vignette. In small 8vo, 5s. 6d. cloth.

\* \* \* This Work has been adopted as a Prize-book in the Schools of Art at South Kensington.

"Contains a large amount of original matter, agreeably conveyed."—*Builder*.

"Much may be learned, even by those who fancy they do not require to be taught, from the careful perusal of this unpretending but comprehensive treatise."—*Art Journal*.

*Wood-Carving.*

INSTRUCTIONS in WOOD-CARVING, for Amateurs; with Hints on Design. By A LADY. In emblematic wrapper, handsomely printed, with Ten large Plates, 2s. 6d.

"The handicraft of the wood-carver, so well as a book can impart it, may be learnt from 'A Lady's' publication."—*Athenæum*.

## AGRICULTURE, GARDENING, ETC.

### *Youatt and Burn's Complete Grazier.*

THE COMPLETE GRAZIER, and FARMER'S and CATTLE-BREEDER'S ASSISTANT. A Compendium of Husbandry. By WILLIAM YOUATT, ESQ., V.S. 12th Edition, very considerably enlarged, and brought up to the present requirements of agricultural practice. By ROBERT SCOTT BURN. One large 8vo. volume, 860 pp. with 244 Illustrations. 17. 1s. half-bound.

"The standard and text-book with the farmer and grazier."—*Farmer's Magazine*.  
 "A treatise which will remain a standard work on the subject as long as British agriculture endures."—*Mark Lane Express*.

### *History, Structure, and Diseases of Sheep.*

SHEEP; THE HISTORY, STRUCTURE, ECONOMY AND DISEASES OF. By W. C. SPOONER, M.R.V.C., &c. Fourth Edition, with fine engravings, including specimens of New and Improved Breeds. 366 pp., 4s. cloth.

### *Production of Meat.*

MEAT PRODUCTION. A Manual for Producers, Distributors, etc. By JOHN EWART. Cr. 8vo, 5s. cloth.

### *Donaldson and Burn's Suburban Farming.*

SUBURBAN FARMING. The Laying Out and Cultivation of Farms adapted to the produce of Milk, Butter and Cheese, Eggs, Poultry, and Pigs. By the late Prof. J. DONALDSON. With Additions, by R. SCOTT BURN. 4s. cloth.

### *English Agriculture.*

A TEXT-BOOK OF AGRICULTURE (THE FIELDS OF GREAT BRITAIN), adapted to the Syllabus of the Science and Art Department. For Elementary and Advanced Students. By HUGH CLEMENTS (Board of Trade). 18mo, 2s. 6d. cloth.

"A clearly written description of the ordinary routine of English farm-life."—*Land*.  
 "A most comprehensive volume, giving a mass of information."—*Agricultural Economist*.

### *Modern Farming.*

OUTLINES OF MODERN FARMING. By R. SCOTT BURN. Soils, Manures, and Crops—Farming and Farming Economy—Cattle, Sheep, and Horses—Management of the Dairy, Pigs, and Poultry—Utilisation of Town Sewage, Irrigation, &c. Sixth Edition. In 1 vol. 1250 pp., half-bound, profusely illustrated, 12s.

### *Farm Engineering.*

FARM ENGINEERING, comprising Draining and Embanking; Irrigation and Water Supply; Roads, Fences, and Gates; Farm Buildings; Barn Implements, etc.; Field Implements, etc.; Agricultural Surveying, Levelling, etc. By Prof. JOHN SCOTT. About 1300 pages, with Several Hundred Illustrations.

[ *In the press* ]

*The Management of Estates.*

LANDED ESTATES MANAGEMENT: Treating of the Varieties of Lands, Methods of Farming, Farm Building, Irrigation, Drainage, &c. By R. SCOTT BURN. 12mo, 3s. cloth.

"A complete and comprehensive outline of the duties appertaining to the management of landed estates."—*Journal of Forestry*.

*The Management of Farms.*

OUTLINES OF FARM MANAGEMENT, and the Organization of Farm Labour. Treating of the General Work of the Farm, Field, and Live Stock, Details of Contract Work, Specialties of Labour, Economical Management of the Farmhouse and Cottage, Domestic Animals, &c. By ROBERT SCOTT BURN. 12mo, 3s.

*Management of Estates and Farms.*

LANDED ESTATES AND FARM MANAGEMENT. By R. SCOTT BURN. (The above Two Works in One Vol.) 6s.

*Hudson's Tables for Land Valuers.*

THE LAND VALUER'S BEST ASSISTANT; being Tables, on a very much improved Plan, for Calculating the Value of Estates. With Tables for Reducing Scotch, Irish, and Provincial Customary Acres to Statute Measure, &c. By R. HUDSON, C.E. New Edition, royal 32mo, leather, gilt edges, elastic band, 4s.

*Ewart's Land Improver's Pocket-Book.*

THE LAND IMPROVER'S POCKET-BOOK OF FORMULÆ, TABLES, and MEMORANDA, required in any Computation relating to the Permanent Improvement of Landed Property. By JOHN EWART, Land Surveyor. 32mo, leather, 4s.

*Complete Agricultural Surveyor's Pocket-Book.*

THE LAND VALUER'S AND LAND IMPROVER'S COMPLETE POCKET-BOOK; consisting of the above two works bound together, leather, gilt edges, with strap, 7s. 6d.

"We consider Hudson's book to be the best ready-reckoner on matters relating to the valuation of land and crops we have ever seen, and its combination with Mr. Ewart's work greatly enhances the value and usefulness of the latter-mentioned.—It is most useful as a manual for reference."—*North of England Farmer*

*Grafting and Budding.*

THE ART OF GRAFTING AND BUDDING. By CHARLES BALTET. Translated from the French. With upwards of 180 Illustrations. 12mo, 3s. cloth boards.

*Culture of Fruit Trees.*

FRUIT TREES, the Scientific and Profitable Culture of. Including Choice of Trees, Planting, Grafting, Training, Restoration of Unfruitful Trees, &c. From the French of DU BREUIL. Fourth Edition, revised. With an Introduction by GEORGE GLENNY. 4s. cl.

"The book teaches how to prune and train fruit-trees to perfection."—*Field*.

*Potato Culture.*

POTATOES, HOW TO GROW AND SHOW THEM. A Practical Guide to the Cultivation and General Treatment of the Potato. By JAMES PINK. With Illustrations. Cr. 8vo, 2s. cl.

*Good Gardening.*

A PLAIN GUIDE TO GOOD GARDENING ; or, How to Grow Vegetables, Fruits, and Flowers. With Practical Notes on Soils, Manures, Seeds, Planting, Laying-out of Gardens and Grounds, &c. By S. WOOD. Third Edition. Cr. 8vo, 5s. cloth.

"A very good book, and one to be highly recommended as a practical guide. The practical directions are excellent"—*Athenæum*.

*Gainful Gardening.*

MULTUM-IN-PARVO GARDENING ; or, How to make One Acre of Land produce £620 a year, by the Cultivation of Fruits and Vegetables ; also How to Grow Flowers in Three Glass Houses, so as to realise £176 per annum clear Profit. By SAMUEL WOOD. 3rd Edition, revised. Cr. 8vo, 2s. cloth.

"We are bound to recommend it as not only suited to the case of the amateur and gentleman's gardener, but to the market grower."—*Gardener's Magazine*.

*Gardening for Ladies.*

THE LADIES' MULTUM-IN-PARVO FLOWER GARDEN, and Amateur's Complete Guide. By S. WOOD. Cr. 8vo, 3s. 6d.

*Bulb Culture.*

THE BULB GARDEN ; or, How to Cultivate Bulbous and Tuberous-rooted Flowering Plants to Perfection. By SAMUEL WOOD. Coloured Plates. Crown 8vo, 3s. 6d. cloth.

*Tree Planting.*

THE TREE PLANTER AND PLANT PROPAGATOR : A Practical Manual on the Propagation of Forest Trees, Fruit Trees, Flowering Shrubs, Flowering Plants, Pot Herbs, &c. Numerous Illustrations. By SAMUEL WOOD. 12mo, 2s. 6d. cloth.

*Tree Pruning.*

THE TREE PRUNER : A Practical Manual on the Pruning of Fruit Trees, their Training and Renovation ; also the Pruning of Shrubs, Climbers, &c. By S. WOOD. 12mo, 2s. 6d., cloth.

*Tree Planting, Pruning, & Plant Propagation.*

THE TREE PLANTER, PROPAGATOR, AND PRUNER. By SAMUEL WOOD, Author of "Good Gardening," &c. Consisting of the above Two Works in One Vol., 5s. half-bound.

*Early Fruits, Flowers and Vegetables.*

THE FORCING GARDEN ; or, How to Grow Early Fruits, Flowers, and Vegetables. With Plans and Estimates for Building Glasshouses, Pits, Frames, &c. By S. WOOD. Crown 8vo, 3s. 6d.

*Market Gardening, Etc.*

THE KITCHEN AND MARKET GARDEN. By Contributors to "The Garden." Compiled by C. W. SHAW, Editor of "Gardening Illustrated." 12mo, 3s. 6d. cl. bds.

*Kitchen Gardening.*

KITCHEN GARDENING MADE EASY. Showing how to prepare and lay out the ground, the best means of cultivating every known Vegetable and Herb, &c. By G. M. F. GLENNY. 12mo, 2s.



*'A Complete Epitome of the Laws of this Country.'*

EVERY MAN'S OWN LAWYER; a Handy-Book of the Principles of Law and Equity. By A BARRISTER. New Edition, with Notes and References. Corrected to the end of last Session. Embracing upwards of 3,500 Statements on Points of Law. Crown 8vo, price 6s. 8d. (saved at every consultation).

COMPRISING THE RIGHTS AND WRONGS OF INDIVIDUALS, MERCANTILE AND COMMERCIAL LAW, CRIMINAL LAW, PARISH LAW, COUNTY COURT LAW, GAME AND FISHERY LAWS, POOR MEN'S LAW, THE LAWS OF

BANKRUPTCY—BILLS OF EXCHANGE—CONTRACTS AND AGREEMENTS—COPYRIGHT—DOWER AND DIVORCE—ELECTIONS AND REGISTRATION—INSURANCE—LIBEL AND SLANDER—MORTGAGES—

SETTLEMENTS—STOCK EXCHANGE PRACTICE—TRADE MARKS AND PATENTS—TRESPASS, NUISANCES, ETC.—TRANSFER OF LAND, ETC.—WARRANTY—WILLS AND AGREEMENTS, ETC.

Also Law for Landlord and Tenant—Master and Servant—Workmen and Apprentices—Heirs, Devisees, and Legatees—Husband and Wife—Executors and Trustees—Guardian and Ward—Married Women and Infants—Partners and Agents—Lender and Borrower—Debtor and Creditor—Purchaser and

Vendor—Companies and Associations—Friendly Societies—Clergymen, Churchwardens—Medical Practitioners, &c.—Bankers—Farmers—Contractors—Stock and Share Brokers—Sportsmen and Gamekeepers—Farriers and Horse-Dealers—Auctioneers, House-Agents—Innkeepers, &c.—Pawnbrokers—Surveyors, &c., &c.

"No Englishman ought to be without this book."—*Engineer.*

"What it professes to be—a complete epitome of the laws of this country, thoroughly intelligible to non-professional readers. The book is a handy one to have in readiness when some knotty point requires ready solution."—*Bell's Life.*

*How to Invest.*

HINTS FOR INVESTORS. Being an Explanation of the Mode of Transacting Business on the Stock Exchange, etc. By WALTER M. PLAYFORD, Sworn Broker. Crown 8vo, 2s. cloth.

*Auctioneer's Assistant.*

THE APPRAISER, AUCTIONEER, BROKER, HOUSE AND ESTATE AGENT, AND VALUER'S POCKET ASSISTANT, for the Valuation for Purchase, Sale, or Renewal of Leases, Annuities, and Reversions, and of property generally; with Prices for Inventories, &c. By JOHN WHEELER, Valuer, &c. Fourth Edition, enlarged, by C. NORRIS. Royal 32mo, cloth, 5s.

*Auctioneering.*

AUCTIONEERS: THEIR DUTIES AND LIABILITIES. By ROBERT SQUIBBS, Auctioneer. Demy 8vo, 10s. 6d. cloth.

"The position and duties of auctioneers treated compendiously and clearly."—*Builder.*

*House Property.*

HANDBOOK OF HOUSE PROPERTY: the Purchase, Mortgage, Tenancy, and Compulsory Sale of Houses and Land; the Law of Dilapidations, &c. By E. L. TARBUCK. 3rd Edit. 3s. 6d.

"We are glad to be able to recommend it."—*Builder.*

"The advice is thoroughly practical."—*Law Journal.*

*Metropolitan Rating.*

METROPOLITAN RATING: a Summary of the Appeals heard before the Court of General Assessment Sessions at Westminster, in the years 1871–80 inclusive. Containing a large mass of very valuable information with respect to the Rating of Railways, Gas and Waterworks, Tramways, Wharves, Public Houses, &c. By EDWARD and A. L. RYDE. 8vo, 12s. 6d. cloth.

Vertical text on the left margin, possibly bleed-through from the reverse side of the page.

**A SELECTION FROM WEALE'S SERIES.**

**ELEMENTARY DECORATION:** A Guide to the Simpler Forms of Every-day Art, as applied to the Interior and Exterior Decoration of Dwelling Houses. By JAMES WILLIAM FACEY, Jun. Illustrated with 68 Explanatory Engravings, principally from Designs by the Author. 2s.

**THE JOINTS MADE AND USED BY BUILDERS** in the Construction of the various kinds of Engineering and Architectural Works, with especial reference to those wrought by Artificers in Erecting and Finishing Habitable Structures. By WYVILL J. CHRISTY, Architect and Surveyor. With upwards of 160 Engravings, 3s.; cloth boards, 3s. 6d.

**CARPENTRY AND JOINERY**, Elementary Principles of, deduced from the Works of the late Professor ROBISON, and T. TREGOLD, C.E. Illustrated. New Edition, with a Treatise on Joinery by E. WYNDHAM TARN. 3s. 6d.; cloth boards, 4s.

**CARPENTRY AND JOINERY.** Atlas of 35 Plates to accompany and illustrate the foregoing book. 4tc, 6s.; cloth boards, 7s. 6d.

**CONSTRUCTION OF ROOFS OF WOOD AND IRON** (an Elementary Treatise), chiefly deduced from the Works of Robison, Tredgold, and Humber. By E. WYNDHAM TARN, M.A., Architect. Second Edition, revised. 1s. 6d.

**HANDRAILING** (A Practical Treatise on). Showing New and Simple Methods for finding the Pitch of the Plank, Drawing the Moulds, Bevelling, Jointing up, and Squaring the Wreath. By G. COLLINGS. With Plates and Diagrams, 1s. 6d.

**THE TIMBER IMPORTER'S, TIMBER MERCHANT'S, AND BUILDER'S STANDARD GUIDE:** comprising copious and valuable Memoranda for the Use of the Retailer and Builder. By RICHARD E. GRANDY. Second Edition, revised. 3s.; cloth boards, 3s. 6d.

**QUANTITIES AND MEASUREMENTS** in Bricklayers', Masons', Plasterers', Plumbers', Painters', Paper-hangers', Gilders', Smiths', Carpenters', and Joiners' work. With Rules for Abstracting and Hints for Preparing a Bill of Quantities, &c. By A. C. BEATON, Surveyor. 1s. 6d.

**THE COMPLETE MEASURER;** the Measurement of Boards, Glass, &c.; Unequal-sided, Square-sided, Octagonal-sided, Round Timber and Stone, and Standing Timber, &c. By RICHARD HORTON. Fourth Edition, 4s.; strongly bound in leather, 5s.

**LOCKWOOD'S BUILDER'S AND CONTRACTOR'S PRICE BOOK** for 1884. With additional Matter and Prices. Revised to the present time. Edited by FRANCIS T. W. MILLER, Architect. 3s. 6d.; half-bound, 4s.

**CROSBY LOCKWOOD & CO., 7, STATIONERS' HALL COURT, E.C.**

A SELECTION FROM WEALE'S SERIES.

**INDUSTRIAL AND USEFUL ARTS.**

- BRICKS AND TILES.** Rudimentary Treatise on the Manufacture of. By EDW. DODSON, M.R.I.B.A. With Additions by C. TOMLINSON, F.R.S. Illustrated. 3s. ; cloth boards, 3s.
- CLOCKS, WATCHES, AND BELLS,** a Rudimentary Treatise on. By Sir EDMUND BECKETT, LL.D., Q.C. Seventh Edition, revised and enlarged. 4s. 6d. limp; 5s. 6d. cloth bds.
- CONSTRUCTION OF DOOR LOCKS.** Compiled from the Papers of A. C. HOBBS, and Edited by CHARLES TOMLINSON, F.R.S. With Additions by R. MALLETT, M.I.C.E. Illus. 2s. 6d.
- THE BRASS FOUNDER'S MANUAL;** Instructions for Modelling, Pattern-Making, Moulding, Turning, Filing, Burnishing, Bronzing, &c. By WALTER GRAHAM. 2s.
- THE ART OF LETTER PAINTING MADE EASY.** By J. G. BADENOCH. With 12 full-page Engravings. 1s.
- THE GOLDSMITH'S HANDBOOK,** containing full Instructions for Alloying and Working. By G. E. GEE. 3s.
- THE SILVERSMITH'S HANDBOOK,** containing full Instructions for Alloying and Working. By G. E. GEE. 3s.
- THE HALL-MARKING OF JEWELLERY PRACTICALLY CONSIDERED.** By G. E. GEE. 3s. ; cl. bds., 3s. 6d.
- COACH BUILDING.** A Practical Treatise, Historical and Descriptive. By J. W. BURGESS. 2s. 6d.; cloth boards, 3s.
- PRACTICAL ORGAN BUILDING.** By W. E. DICKSON, M.A., Precentor of Ely Cathedral. Illustrated. 2s. 6d.

**MECHANICAL ENGINEERING, &c.**

- THE WORKMAN'S MANUAL OF ENGINEERING DRAWING.** By JOHN MAXTON. Fifth Edition. Illustrated with 7 Plates and nearly 350 Cuts. 3s. 6d. ; cloth boards, 4s.
- FUEL,** its Combustion and Economy. By C. W. WILLIAMS, A.I.C.E. With extensive additions by D. K. CLARK, C.E. 3s. 6d.
- ROADS AND STREETS,** the Construction of, in Two Parts: I. THE ART OF CONSTRUCTING COMMON ROADS, by HENRY LAW, C.E., revised by D. K. CLARK, C.E.; II. RECENT PRACTICE, including pavements of Stone, Wood, and Asphalte, by D. K. CLARK. M.I.C.E. 4s. 6d.; cloth boards, 5s.
- THE CONSTRUCTION OF GAS WORKS AND THE MANUFACTURE AND DISTRIBUTION OF COAL GAS.** By S. HUGHES, C.E. Sixth Edition. Re-written by W. RICHARDS, C.E. 4s. 6d.; cloth boards, 5s.
- WELLS AND WELL-SINKING.** By J. G. SWINDELL, A.R.I.B.A., and G. R. BURNETT, C.E. Revised Edition. 2s.
- MATERIALS AND THEORETICAL AND PRACTICAL TREATISES ON THE CONSTRUCTION AND ERECTION OF WORKS OF CONSTRUCTION.** By J. G. SWINDELL, A.R.I.B.A., and G. R. BURNETT, C.E. Revised Edition. 2s. 6d.

CROSBY LOCKWOOD &

COURT, E.C.

